



THE Eco



Project _____

Item No. _____

Quantity _____

PERFORMANCE

Utilizing TurboChef's patented technology to rapidly cook food without compromising quality, the Eco provides superior cooking performance while requiring less space and consuming less energy.

VENTILATION

- Ventless certification
- EPA 202 test (8 hr):
 - Product: 162 Pepperoni Pizzas
 - Results: 0.89 mg/m³
 - Ventless Requirement: <5.00 mg/m³
- Internal catalytic filtration to limit smoke, grease, and odor emissions.

EXTERIOR CONSTRUCTION

- 430 stainless steel outer wrap and door
- Cool-to-touch exterior; all surfaces below 122°F/50°C
- Ergonomic door handle

INTERIOR CONSTRUCTION

- 201/304 stainless steel
- Fully welded and insulated cook chamber
- Removable rack and lower jetplate

STANDARD FEATURES

- Single motor vertically circulates air impingement
- Top-launched microwave system
- Stirrer to help ensure even distribution of air and microwave
- Integral recirculating catalytic converter for UL® (KNLZ) listed ventless operation
- External air filtration
- Smart menu system capable of storing up to 256 recipes
- Customizable menu settings via Wi-Fi (additional fees apply), USB, or manual entry
- Flash firmware updates via USB
- Single or dual-temperature interface
- Self-diagnostics for monitoring oven components and performance
- Smart Voltage Sensor Technology* (U.S. only)
- Stackable (requires stacking kit)
- Includes plug and cord (6 ft. nominal)
- Warranty – 1 year parts and labor
- Powder-coated color options available (additional fees apply):
 - Traffic Red (RAL-3020)
 - Yellow Green (RAL-6018)
 - Pure White (RAL-9010)
 - Jet Black (RAL-9005)
 - Blue (RAL-Custom TurboChef Blue)

COMES WITH STANDARD ACCESSORIES

- 1 Bottle Oven Cleaner (103180)
- 1 Bottle Oven Guard (103181)
- 2 Trigger Sprayers (103182)
- 2 Solid Aluminum Pans (i1-9496)
- 1 Aluminum Paddle (i1-9716)

CERTIFICATIONS

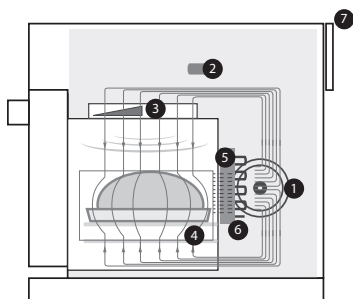

1. Blower Motor
2. Top-launched Microwave
3. Stirred Impinged Air (Top) and Microwave
4. Air Impingement (Bottom)
5. Catalytic Converter
6. Heater
7. Air Filter

This product conforms to the ventilation recommendations set forth by NFPA96 using EPA202 test method.





* Smart Voltage Sensor Technology does not compensate for lack of or over voltage situations. It is the responsibility of the owner to supply voltage to the unit according to the specifications on the back of this sheet.



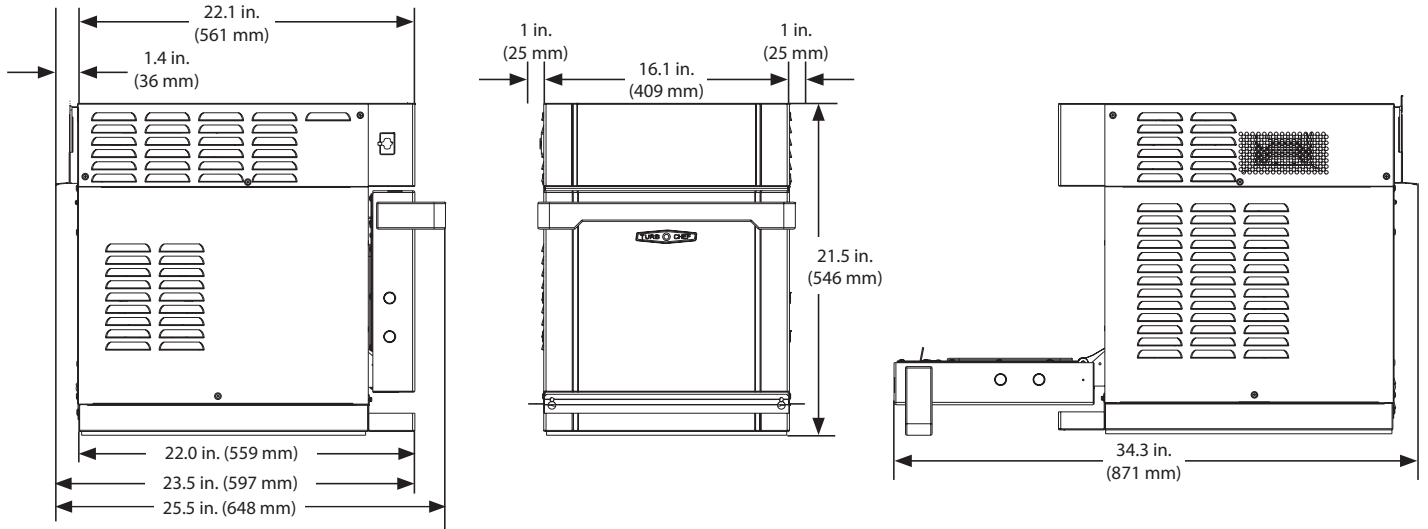

† Ventless certification is for all food items except for foods classified as "fatty raw proteins." Such foods include bone-in, skin-on chicken, raw hamburger meat, raw bacon, raw sausage, steaks, etc. If cooking these types of foods, consult local HVAC codes and authorities to ensure compliance with ventilation requirements.

Ultimate ventless allowance is dependent upon AHJ approval, as some jurisdictions may not recognize the UL certification or application. If you have questions regarding ventless certifications or local codes, please email ventless.help@turbochef.com

TurboChef reserves the right to make substitutions of components or change specifications without prior notice.

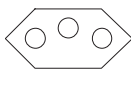

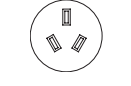
DIMENSIONS		
Single Units		
Height	21.5"	546 mm
Width	16.1"	409 mm
Depth	23.5"	597 mm
Weight	118 lb.	54 kg
Cook Chamber		
Height / Usable Height	7.2" / 5.7"	183 mm / 145 mm
Width	12.5"	318 mm
Depth / Usable Depth	10.5" / 9.3"	267 mm / 236 mm
Volume / Usable Volume	0.54 cu.ft. / 0.38 cu.ft.	15.3 liters / 10.7 liters
Wall Clearance (Oven not intended for built-in installation)		
Top	5"	127 mm
Sides	1"	25 mm
ELECTRICAL SPECIFICATIONS – STAINLESS STEEL, SINGLE PHASE		
Eco US Model (ECO-9500-1) – US/Canada		
Voltage	208/240 VAC	 L 6-20
Frequency	60 Hz	
Current	20 Amps	
Max Input/MW/Heaters & Blowers	3.6 kW/2.0 kW/4.0 kW*	
Eco EU Model (ECO-9500-7-EU) – Europe		
Voltage	230 VAC	 CEE7/V11
Frequency	50 Hz	
Current	16 Amps	
Max Input/MW/Heaters & Blowers	3.3 kW/2.0 kW/3.7 kW*	
Eco UK Model (ECO-9500-13-UK) – United Kingdom		
Voltage	230 VAC	 BS1363
Frequency	50 Hz	
Current	13 Amps	
Max Input/MW/Heaters & Blowers	2.6 kW/2.0 kW/2.9 kW*	
Eco JK Model 50 Hz (ECO-9500-25-JK) – Japan JK Model 60 Hz (ENC-9500-31-JK) – Japan		
Voltage	200 VAC	 JIS C 8303
Frequency	50 Hz or 60 Hz	
Current	20 Amps	
Max Input/MW/Heaters & Blowers	3.5 kW/2.0 kW/4.0 kW*	

Eco BK Model (ECO-9500-37-BK) – Brazil		
Voltage	220 VAC	 NBR14136
Frequency	60 Hz	
Current	20 Amps	
Max Input/MW/Heaters & Blowers	3.6 kW/2.0 kW/4.0 kW*	
Eco LA Model (ECO-9500-49-LA) – Latin America (cleaner and guard included) LA Model (ECO-9500-55-LA) – Latin America (without cleaner and guard)		
Voltage	220 VAC	 NEMA 6-20P
Frequency	60 Hz	
Current	20 Amps	
Max Input/MW/Heaters & Blowers	3.6 kW/2.0 kW/4.0 kW*	
Eco AK Model (ECO-9500-19-AK) – Australia		
Voltage	240 VAC	 CLIPSAL 425HD
Frequency	50 Hz	
Current	19 Amps	
Max Input/MW/Heaters & Blowers	3.5 kW/2.0 kW/4.0 kW*	
Eco SK Model (ECO-9500-43-SK) – Saudi Arabia		
Voltage	230 VAC	 IEC 309
Frequency	60 Hz	
Current	16 Amps	
Max Input/MW/Heaters & Blowers	3.3 kW/2.0 kW/3.7 kW*	
SHIPPING INFORMATION		
U.S.: All ovens shipped within the U.S. are packaged in a double-wall corrugated box banded to a wooden skid. International: All International ovens shipped via Air or Less than Container Loads are packaged in wooden crates.		
Box size: 33" x 24" x 34" (838 mm x 610 mm x 864 mm) Crate size: 33" x 24" x 34" (838 mm x 610 mm x 864 mm) Item class: 110 NMFC #26710 HS code 8419.81		
Approximate boxed weight: 163 lb. (74 kg) Approximate crated weight: 191 lb. (87 kg)		
Minimum entry clearance required for box: 34.5" (876 mm) Minimum entry clearance required for crate: 34.5" (876 mm)		

* Under normal operation, the oven will not exceed the max input value.

⚠ TurboChef recommends installing a type D circuit breaker for European installations.

TurboChef Global Operations
 2801 Trade Center Drive | Carrollton, Texas 75007 USA
 US: 800.90TURBO (800.908.8726) | International: +1 214.379.6000
 Fax: +1 214.379.6073 | www.turbochef.com