

A dramatic mountain landscape with a forested valley and rocky peaks under a cloudy sky. The foreground is dominated by golden-brown, scrubby vegetation on a steep slope. In the middle ground, a dense forest of tall, thin trees covers a valley floor. The background features rugged, rocky mountain peaks partially shrouded in mist or low clouds. The overall lighting is soft and atmospheric, suggesting a late afternoon or early morning setting.

# DEDON

COLLECTIONS 2019





# DEDON

COLLECTIONS 2019





# BENVENUTI

If the Philippines is DEDON's second home, then Italy is surely our third. Since the beginning, we've produced our fabrics, ceramics and aluminum furniture in collaboration with the most passionate Italian manufacturers. This year, a Danish-Italian duo, GamFratesi, designed our refined and contemporary new AIR collection of shell chairs. What better time, then, for the DEDON Tour du Monde to visit this country of endless beauty and exceptional quality of life?

We went searching for the authentic Italy of small towns, remote villages and mellow nature. Along the way, we discovered the perfect house. Settled in a landscape of soft hills, it's the kind of place that invites one to string lights across a long table and savor dinner with friends — which is exactly what we did. The walls of the centuries-old farm were the perfect backdrop for BREA, our new lounge system by Barber and Osgerby. The countryside invited us to explore and test our outdoor lighting in nature.

Once again, Italy has shared its abundance with us. Now — in beautiful new designs, compelling new stories and gorgeous new photos — it's our turn to share it with you.

# PRODUCTS

**AHNDA**  
98 – 101 | 140 – 143

**AIIR**  
50 – 57 | 144 – 149

**BREA**  
08 – 13 | 156 – 163

**BRIXX**  
68 – 73 | 164 – 169

**CLASSICS**  
80 – 85

**DALA**  
24 – 27 | 170 – 173

**DEAN**  
36 – 39 | 174 – 175

**ICONICS**  
42 – 49

**LIGHTING**  
102 – 105 | 266 – 275

**LOU**  
88 – 91 | 176 – 181

**LOUNGE**  
76 – 79 | 182 – 189

**MBRACE**  
14 – 23 | 192 – 199

**MU**  
64 – 67 | 200 – 205

**PLAY**  
96 – 97 | 214 – 217

**RAYN**  
92 – 95 | 220 – 227

**SEASHELL**  
86 – 87 | 230 – 233

**SEAYOU**  
74 – 75 | 240 – 241

**SEAX**  
58 – 63 | 234 – 239

**SLIM LINE**  
40 – 41 | 242 – 245

**TIBBO**  
28 – 35 | 254 – 259

# STORY

**EDITORIAL**  
05

**COLLECTIONS**  
08 – 105

**DESIGNER**  
106 – 109

**FIBER & CEBU**  
110 – 113

**DEDON STORY**  
114 – 115

**ALL MATERIALS**  
116 – 119

**PRODUCTS BY CATEGORY**  
Dining Chairs & Bar Stools 122 – 123  
Tables 124 – 125  
Lounging 126 – 127  
Lounge Chairs 128 – 129  
Beach Chairs 130 – 131  
Side Tables 132 – 133  
Iconics 134 – 135  
Lighting & Accessories 136 – 137

**PRODUCTS BY COLLECTION**  
138 – 281

**INFORMATION**  
282 – 306





COLLECTION  
**BREA**





A lounge system of elegant simplicity. Indoor luxury outdoors. Upholstery can be effortlessly removed. Design by Edward Barber and Jay Osgerby.

*Sistema lounge de elegante sencillez. Lujo interior en el exterior. Fundas fácilmente extraíbles. Un diseño de Edward Barber y Jay Osgerby.*











COLLECTION  
**MBRACE**





MBRACE LOUNGE CHAIR











Shapes that invite, embrace, cocoon. A lively material mix of fiber and premium teak. Triaxial weave in five vivid color combinations. Design by Sebastian Herkner.

*Formas que atraen, abrazan y abrigan. Una viva mezcla de materiales a base de fibra y teca de primera calidad. Tejido triaxial disponible en cinco alegres combinaciones cromáticas. Un diseño de Sebastian Herkner.*









COLLECTION  
**DALA**





A celebration of artisanship. Sophisticated weaving pattern in decorative colorways. Circular seating. Contemporary. Design by Stephen Burks.

*Homenaje a la artesanía. Elegante diseño trenzado en decorativas paletas cromáticas. Asientos circulares. Contemporánea. Un diseño de Stephen Burks.*

DALA LOUNGING







COLLECTION  
**TIBBO**





TIBBO BEACH CHAIRS

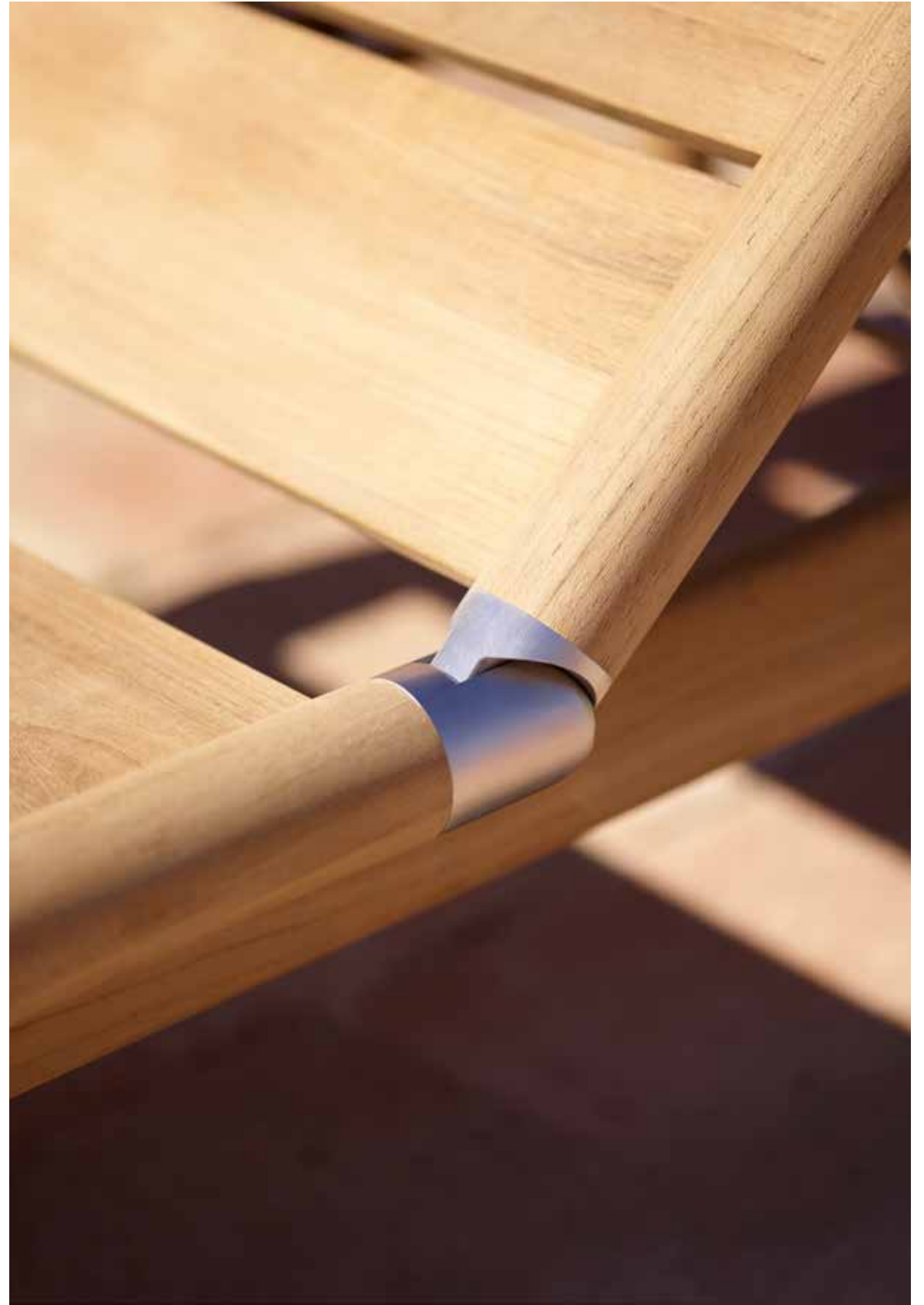





A rich, luxurious, modern, premium-teak collection for dining, lounging and sunbathing. Design by Edward Barber and Jay Osgerby.

*Una colección rica, cómoda, moderna y elaborada con teca de primera calidad. Cálida y acogedora y a la vez racional, ligera y sólida. Un diseño de Edward Barber y Jay Osgerby.*

TIBBO DINING

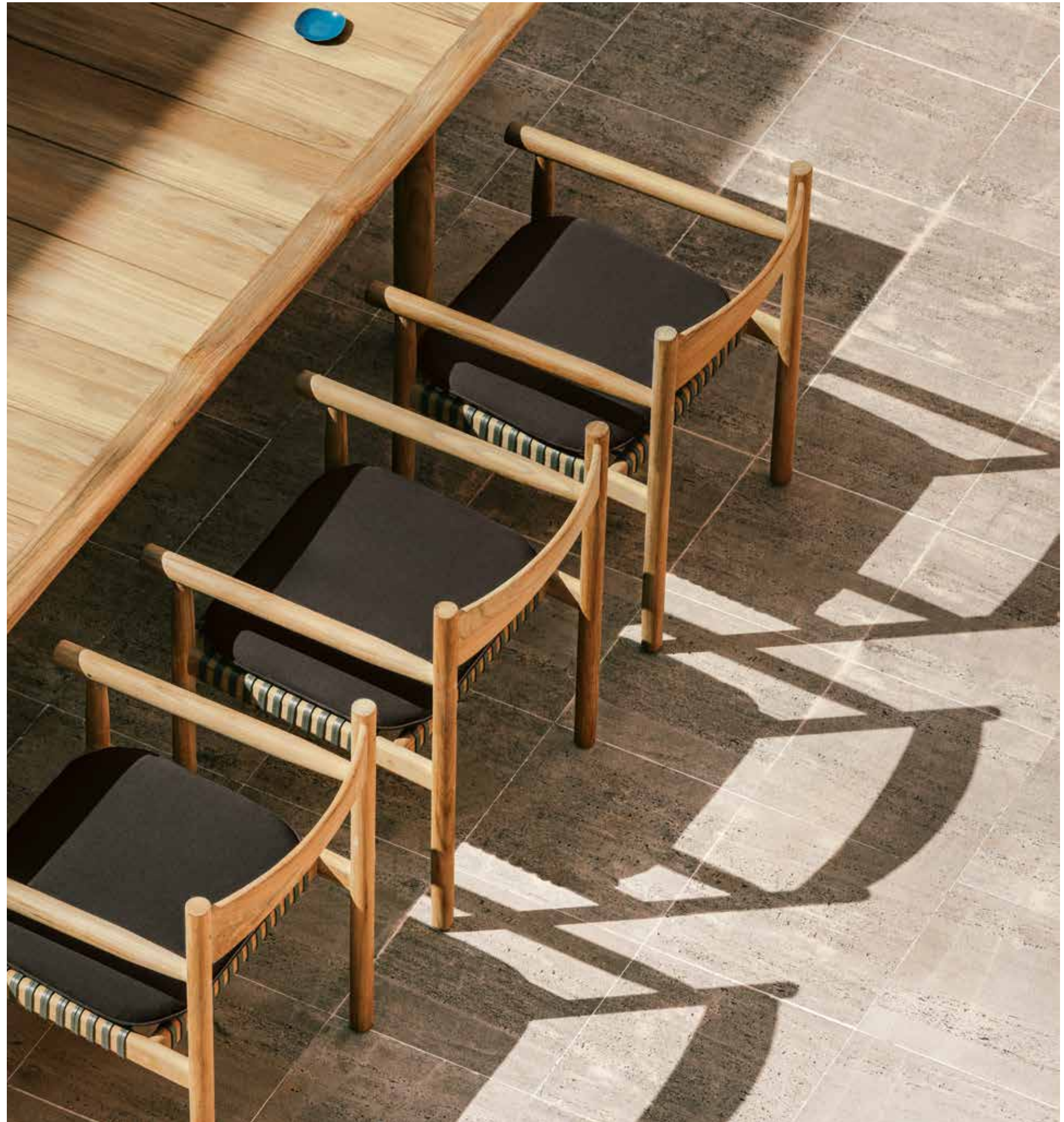





TIBBO LOUNGE CHAIR





COLLECTION  
**DEAN**





DEAN DINING



A breakthrough in sling-chair construction. Timeless and sophisticated structure. Luxurious double-sling fabric. Teak armrest insets. Design by Jean-Marie Massaud.

*Un auténtico avance en la fabricación de sillas Sling. Estructura atemporal y sofisticada. Cómodo tejido de doble capa. Reposabrazos incrustados con teca. Un diseño de Jean-Marie Massaud.*





COLLECTION  
**SLIM LINE**

Structure and surface fused in a singular form. Lounge elements inspired by the appearance of a folded blanket. Reduced to pure essence. Design by Jean-Marie Massaud.

*La estructura y la superficie se fusionan creando una forma única. Elementos lounge inspirados en el aspecto de una manta doblada. Reducido a la esencia pura.*

*Un diseño de Jean-Marie Massaud.*





ICONICS

# NESTREST



Design by  
Daniel Pouzet and Fred Frety

A true icon of modern design. Inspired by nature, this is cocooning at its best — intimate, airy, perfect for dreaming or just being.

*Un icono del diseño contemporáneo. Inspirada en la naturaleza, esta colección protege y abriga como nunca antes lo hecho otra colección: íntima, liviana y perfecta para soñar o simplemente pasar un rato.*





ICONICS  
**ORBIT**



Design by  
Richard Frinier

The original outdoor classic. Generously proportioned and luxuriously comfortable. Easy to move and rotate with the sun. Shady cloth canopy.

*El clásico original para espacios exteriores. De generosas proporciones, extremadamente cómodo y fácil de mover y girar hacia donde está el sol. Capota de tela.*





ICONICS

# SWINGREST



Design by  
Daniel Pouzet

The ultimate hanging lounger, spacious and inviting. Features a stylish weaving pattern and swiveling tabletop.

*El sofá colgante perfecto, amplio y tentador. Presenta trenzados elegantes y un tablero rotatorio.*





ICONICS  
**TIGMI**



Design by  
Jean-Marie Massaud

A sofa so deep it doubles as a daybed for two. Paired with a matching woven roof, it becomes a sophisticated shelter, plush and private.

*Un sofá tan profundo que sirve como cama de día para dos. Combinado con una techo trenzado a juego, se convierte en una cabaña sofisticada, lujosa e íntima.*





COLLECTION  
**AIR**





The classic shell chair, reinterpreted for today. Lightness and transparency. Advanced injection-molded seating. Tapered teak legs. Indoors or out. Design by GamFratesi.

*La clásica silla shell reinterpretada a lo moderno. Ligereza y transparencia. Avanzados asientos moldeados por inyección. Patas de teca afiladas. Para uso interior y exterior. Un diseño de GamFratesi.*

AIR DINING







AIR DINING

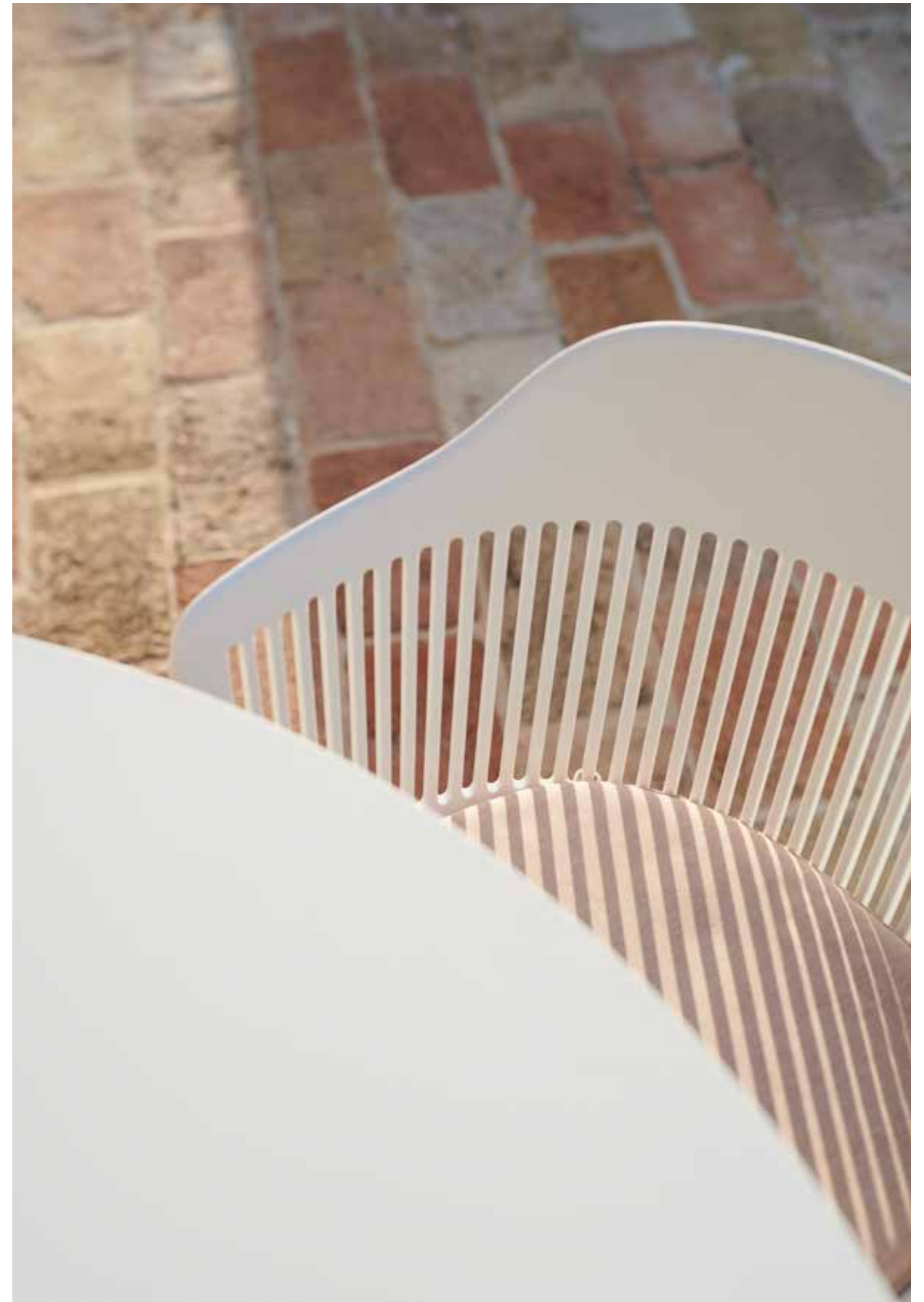









COLLECTION  
**SEAX**





An ultra-refined director's chair. Its sturdy, streamlined aluminum frame is precision-engineered. Inspired by America's Cup racing yachts. Design by Jean-Marie Massaud.

*Una silla de director extremadamente refinada. Su robusto y aerodinámico bastidor de aluminio ha sido diseñado con alta precisión. Inspirada en los veleros de la Copa América. Un diseño de Jean-Marie Massaud.*

SEAX DINING











COLLECTION  
**MU**





A modular lounge in a subtle mix of woven fiber, aluminum and high-end upholstery. Its name is a Zen term meaning 'reduced to pure essence'. Design by Toan Nguyen.

*Un sistema de sofás modulares con una mezcla sutil de elegantes fibras DEDON entrelazadas, base de aluminio y tapizado de calidad superior. Lleva el nombre de un término zen que significa „reducido a la pura esencia“.*  
*Un diseño de Toan Nguyen.*





COLLECTION  
**BRIXX**





Upholstered rectangular modules. Playful yet functional. 360° accessibility. Fixed or flexible backrests. Created with leading Italian upholsterers. Design by Lorenza Bozzoli.

*Módulos rectangulares tapizados. Divertida y a la vez funcional. 360° accesible. Respaldos fijos o flexibles. Creada en colaboración con los mejores tapiceros italianos. Un diseño de Lorenza Bozzoli.*

BRIXX LOUNGING











COLLECTION  
**SEAYOU**

A contemporary upgrade of the classic deck chair. Perfect ergonomics. Integrated headrest. Effortless folding. Stainless-steel adjuster. Design by Jean-Marie Massaud.

*La versión contemporánea de la clásica silla plegable. Perfectamente ergonómica. Cojín reposacabezas integrado. Fácil de plegar. Mecanismo de ajuste de acero inoxidable. Un diseño de Jean-Marie Massaud.*





COLLECTION  
**LOUNGE**





LOUNGE LOUNGING

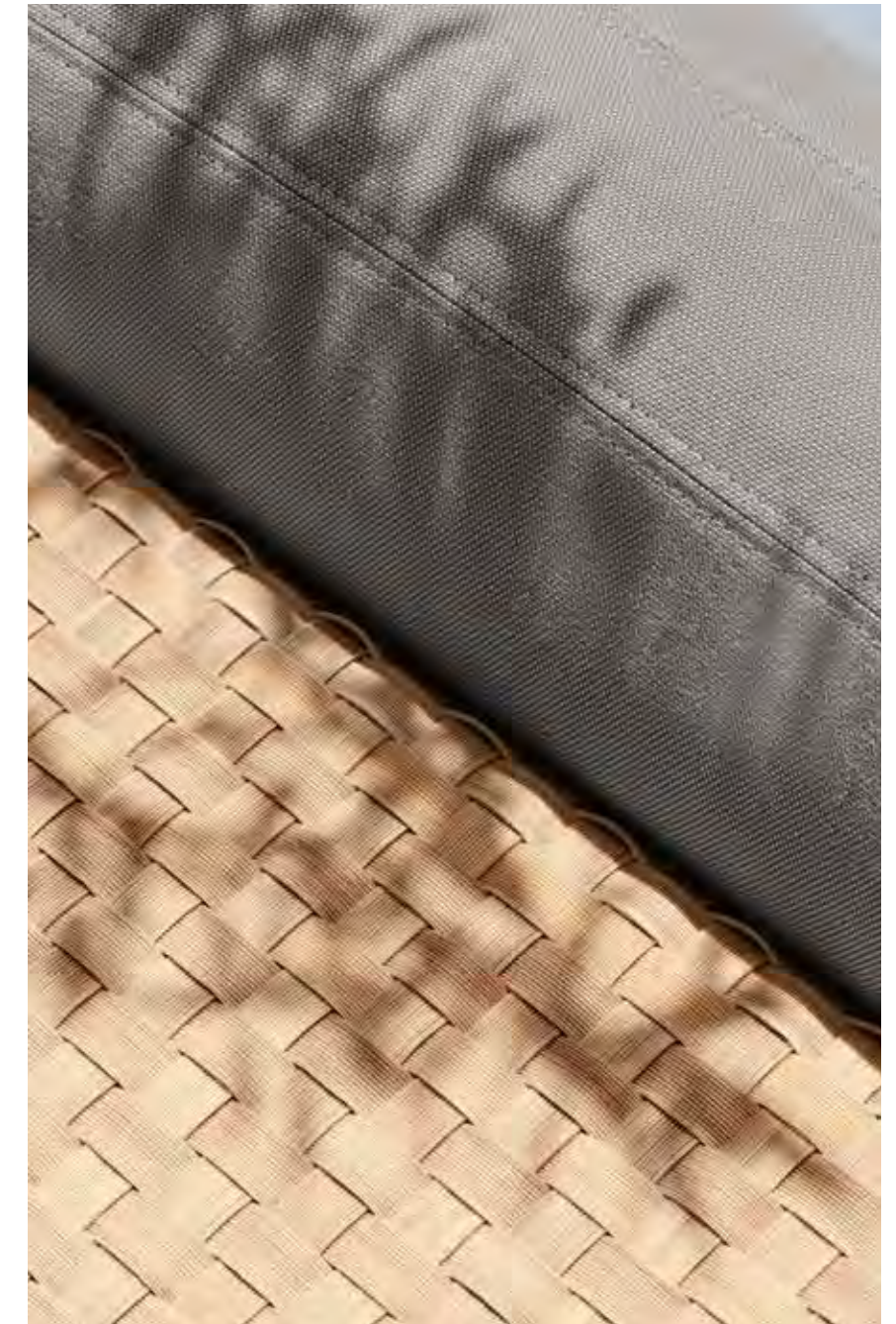

The original outdoor lounge system. Crisp lines, thick cushions and a smart bracket solution for combining modules in unlimited configurations. Design by Frank Ligthart.

*El sistema original lounge para espacios exteriores. Líneas definidas, cojines gruesos y una inteligente solución a base de horquillas que permite combinar los módulos de muchas formas diferentes. Un diseño de Frank Ligthart.*





CLASSICS

# PANAMA



Design by  
Richard Frinier

Warm and inviting. Flowing lines and gently flaring curves.  
A wide range of pieces, for every outdoor need.

*Cálida y acogedora. Líneas limpias y curvas elegantes y  
suaves. Una amplia gama de piezas para cualquier espacio  
exterior.*





CLASSICS

# BARCELONA



Design by  
Richard Frinier

A delicate balance of traditional and modern, just like the dynamic city it is named for. Generous proportions. Gracious lines. Understated weave.

*Un sutil equilibrio entre lo tradicional y lo moderno, igual que la ciudad que lleva su nombre. Dimensiones generosas. Líneas elegantes. Trenzado sutil.*





CLASSICS  
**TANGO**



Design by  
Richard Frinier

Bold curves and a rhythmic herringbone weave create a distinctive look. A wide range of settings, from dining area to lounge to poolside.

*Curvas atrevidas y un rítmico trenzado en espiga le aportan un aspecto inconfundible. Para una amplia gama de ambientes, desde comedores o zonas lounge hasta piscinas.*





COLLECTION  
**SEASHELL**

Organic contours. Backrests that embrace. Sturdy yet lightweight construction. An airy, artful weave. Practical and breathable. Design by Jean-Marie Massaud.

*Contornos orgánicos. Respaldos que abrazan. Construcción fuerte y a la vez ligera. Trenzado liviano e ingenioso. Práctica y transpirable. Un diseño de Jean-Marie Massaud.*





COLLECTION  
**LOU**





A contemporary modular lounge. Overlapping planes, semi-open weave and a floating structure convey lightness. A rich material mix of accessories. Design by Toan Nguyen.

*Un sofá modular contemporáneo. Niveles superpuestos, trenzado semiabierto y una estructura flotante que le aporta ligereza. Complementos elaborados con una rica mezcla de materiales. Un diseño de Toan Nguyen.*

LOU LOUNGING

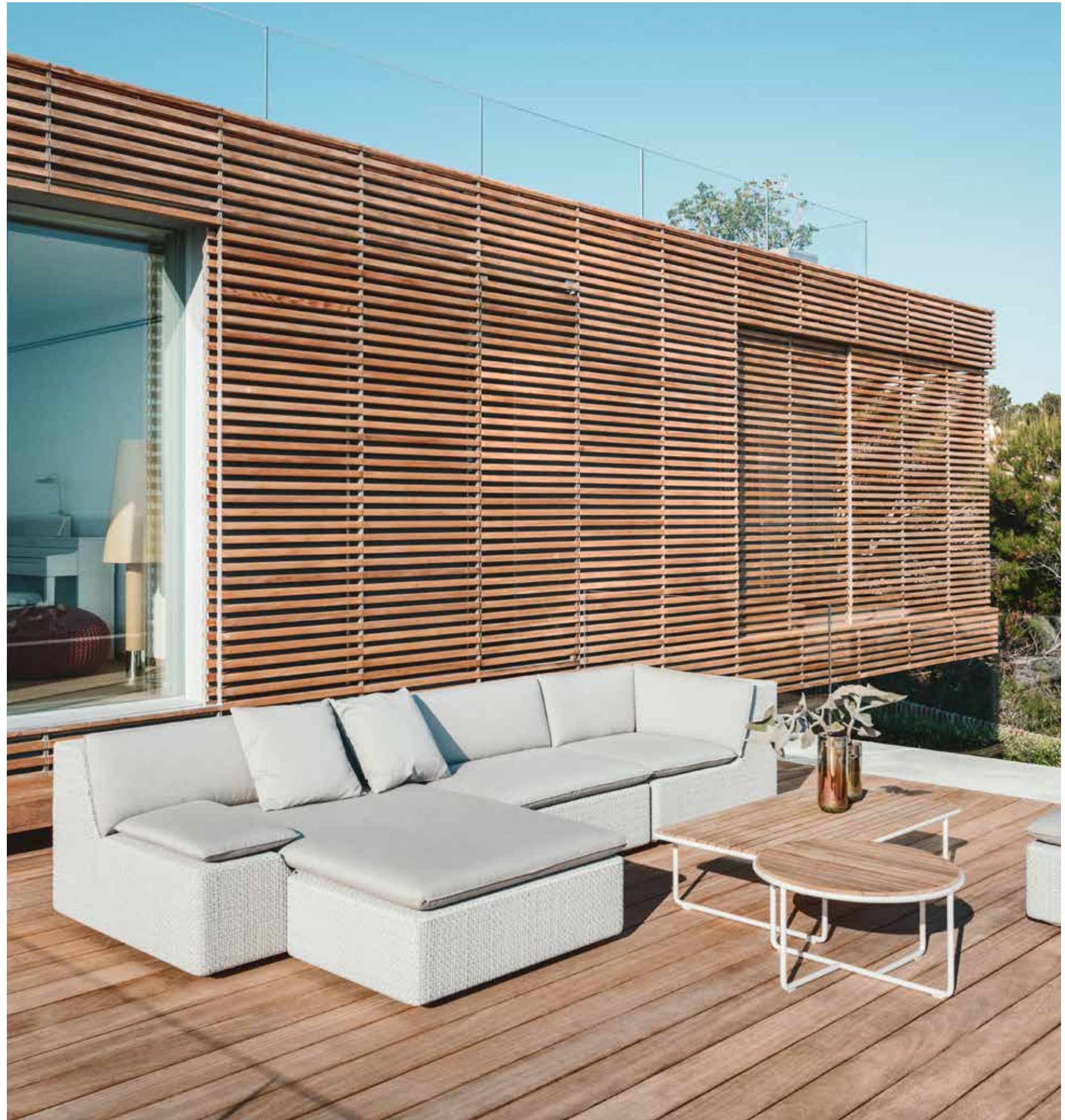





COLLECTION  
**RAYN**





RAYN LOUNGING

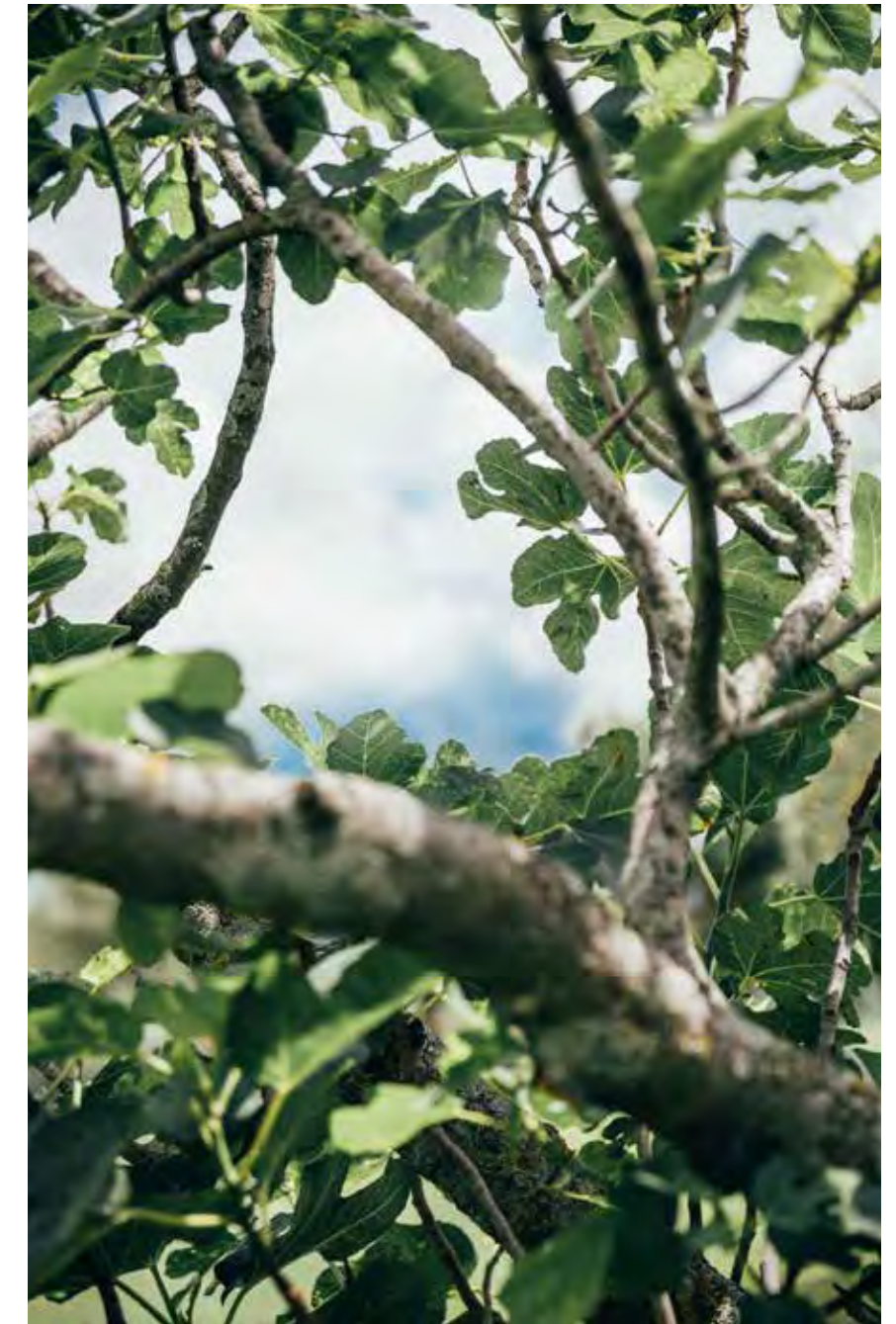

A lounge system of deep proportions and high sophistication. Its asymmetric beauty is accentuated by armrests so wide they double as side tables. Design by Philippe Starck.

*Sistema lounge profundo y altamente sofisticado. Los reposabrazos, tan anchos que podrían servir de mesa auxiliar, acentúan su belleza asimétrica. Un diseño de Philippe Starck.*





COLLECTION  
**PLAY**

Technology meets craft. The world's first chair to combine an injection-molded frame with a hand-woven finish. Simple and iconic. Design by Philippe Starck.

*Tecnología y artesanía se unen en uno. Es la primera silla del mundo que combina una estructura moldeada por inyección con un trenzado hecho manualmente. Sencilla e icónica. Un diseño de Philippe Starck.*





COLLECTION  
**AHND**





AHNDA LOUNGE CHAIR



Loungers and sofas in an open weave of “transparent upholstery” that reveals the circle structure beneath. Great for curling up or sprawling out. Design by Stephen Burks.

*Butacas y sofás con un trenzado abierto de „tapicería transparente” que revela la estructura circular de la base. Ideal para acurrucarse o despatarrarse. Un diseño de Stephen Burks.*





CATEGORY  
**LIGHTING**

Three unique outdoor lighting systems. Each casts  
6-plus hours of ambient light per charge.

LOON by Sebastian Herkner.

BABYLON by Harry-Paul.

THE OTHERS by Stephen Burks.

*Tres singulares sistemas de iluminación para el exterior.  
Cada uno de ellos ofrece más de 6 horas de luz ambiental  
por carga.*

*LOON de Sebastian Herkner.*

*BABYLON de Harry-Paul.*

*THE OTHERS de Stephen Burks.*









## DESIGNERS



---

**GAMFRATESI AIIR**

Cross-cultural duo Stine Gam and Enrico Fratesi expand on their native Danish and Italian design traditions, taking an experimental approach to materials and technique. Based in Copenhagen, Denmark.

*El dúo multicultural Stine Gram y Enrico Fratesi trabaja según las costumbres del diseño propias de su tierra: Italia y Dinamarca. Lo hacen con un enfoque experimental en cuanto a los materiales y técnicas. Con sede en Copenhague, Dinamarca.*

---

**EDWARD BARBER & JAY OSGERBY BREA, TIBBO**

Edward Barber and Jay Osgerby's diverse and acclaimed body of work spans industrial design, furniture, lighting, site-specific installations and public commissions. Based in London, UK.

*Las diversas y aclamadas obras de Edward Barber y Jay Osgerby abarcan diseño industrial, mobiliario, iluminación, instalaciones específicas para un espacio en concreto y obras públicas. Con sede en Londres, Reino Unido.*

---

**LORENZA BOZZOLI BRIXX, LA MALLE, PORCINI**

A fashion designer by training, Lorenza Bozzoli brings a fresh approach to furniture design. Her work has been showcased in leading international venues. Based in Milan, Italy.

*La diseñadora de moda por entrenamiento, Lorenza Bozzoli aporta un nuevo enfoque al diseño de muebles. Su obra ha sido exhibida en los principales lugares internacionales. Con sede en Milán, Italia.*

---

**JEAN-MARIE MASSAUD DEAN, SATELLITE, SEASHELL, SEAX, SEAYOU, SLIM LINE, TIGMI**

From furniture to store interiors to a world-famous football stadium, Jean-Marie Massaud is renowned for his signature mix of elegance and comfort, heritage and zeitgeist. Based in Paris, France.

*Desde mobiliario e accesorios de tiendas hasta un campo de fútbol mundial famoso, Jean-Marie Massaud es conocido por su inconfundible mezcla de elegancia y confort, herencia y espíritu de época. Con sede en París, Francia.*

---

**SEBASTIAN HERKNER LOON, MBRACE**

Sebastian Herkner's work merges cultural contexts by juxtaposing materials, combining new technologies with traditional craftsmanship, and drawing attention to small details. Based in Offenbach, Germany.

*La obra de Sebastian Herkner fusiona contextos culturales yuxtaponiendo materiales, combinando nuevas tecnologías con artesanía tradicional y llamando la atención sobre pequeños detalles. Con sede en Offenbach, Alemania.*

---

**STEPHEN BURKS AHNDA, DALA, THE OTHERS**

Stephen Burks frequently explores the role of handwork in his innovative and award-winning designs. He has collaborated with artisans and craftspeople around the globe. Based in New York, USA.

*Stephan Burks explora a menudo el papel del trabajo manual en sus diseños innovadores y galardonados. Ha colaborado con artesanos al rededor del mundo. Con sede en Nueva York, EE.UU.*

---

**TOAN NGUYEN LOU, MU, WA**

Toan Nguyen takes a multidisciplinary approach to design, focusing on development in a wide range of fields, from furniture to technology products. Based in Milan, Italy.

*Toan Ngyen persigue un enfoque multidisciplinario del diseño, contrándose en el desarrollo de una amplia variedad de áreas, tanto mobiliario como productos tecnológicos. Con sede en Milán, Italia.*

---

**PHILIPPE STARCK PLAY WITH DEDON (WITH EUGENI QUITLLET), RAYN**

From lemon squeezers to mega-yachts, no object is too small or too big to attract the unique eye and boundless curiosity of world-renowned designer Philippe Starck. Based in Paris, France.

*Desde exprimidores de limones hasta megayates, ningún objeto es demasiado grande o pequeño para captar el interés e infinita curiosidad del famoso diseñador Philippe Starck. Con sede en París, Francia.*

---

**DANIEL POUZET NESTREST (WITH FRED FRETU), SWINGREST**

Daniel Pouzet studied in Paris and his native Bucharest. His work combines architectural rigor with a sense of fantasy and play, frequently drawing inspiration from the natural world. Based in Draguignan, France.

*Daniel Pouzet estudió en París y su país natal Bucarest. Su obra combina el rigor arquitectónico con un toque de fantasía y diversión, a menudo inspirándose en la naturaleza. Con sede en Draguignan, Francia.*

---

**RICHARD FRINIER BARCELONA, ORBIT & ORBIT XXL, PANAMA, TANGO**

American-born Richard Frinier has been described as "the king of outdoor furniture." He is known for his mastery of a wide range of styles, from classic to contemporary. Based in Long Beach, USA.

*El estadounidense Richard Frinier, se conoce como „el rey del mobiliario exterior“. Es conocido por su dominio de una amplia variedad de estilos, tanto clásicos como contemporáneos. Con sede en Long Beach, EE.UU.*

---

**HARRY-PAUL BABYLON**

Harry-Paul is known for the air of mystery that surrounds his objects. His bold, forward-looking approach involves experimentation with materials and topologies. Based in Barcelona, Spain.

*Harry-Paul es conocido por el aire de misterio que rodea sus objetos. Su enfoque, audaz y progresista incluye la experimentación con materiales y topologías. Con sede en Barcelona, España.*

---

**FRANK LIGTHART LOUNGE**

Dutch designer Frank Ligthart has always loved the combination of aesthetics and technics. His work is an expression of his passion for turning concepts into tangible realities. Based in Antwerp, Belgium.

*El diseñador holandés Frank Lightart siempre le ha encantado la combinación de estética y la técnica. Su trabajo es una expresión de su pasión por convertir conceptos en realidades tangibles. Con sede en Amberes, Bélgica.*

---

**EUGENI QUITLLET PLAY WITH DEDON (WITH PHILIPPE STARCK)**

Eugeni Quitllet's work is characterized by meticulous attention to detail, uncompromising standards of quality and the passion he puts into each and every creation. Based in Barcelona, Spain.

*La obra de Eugeni Quitllet se caracteriza por su atención meticuloas al detalle, estándares de calidad intransigentes y la pasión que pone en cada una de sus creaciones. Con sede en Barcelona, España.*

---

**EOOS MANGROVE**

Austrian design trio EOOS is interested in the unique creations that arise when artistic traditions, cultural history and ancient mythology are combined with new technologies. Based in Vienna, Austria.

*El trío de diseñadores austriacos EOOS se interesa por las singulares creaciones que surgen cuando las tradiciones artísticas, la historia cultural y la mitología antigua se unen con las nuevas tecnologías. Con sede en Viena, Austria.*





Unique among outdoor brands, DEDON owns and operates the entire production of its luxurious hand-woven furniture, from fiber to frame to finished product.

Strong enough to withstand the harshest conditions. Supple enough to weave into art. Versatile enough to inspire the world's leading designers for nearly 30 years. That's DEDON Fiber, the standard of quality. Researched, developed and manufactured at the company's own state-of-the-art production facilities in Northern Germany. Tested in the lab for resistance to UV rays, saltwater, chlorine, sunscreen and extremes of temperatures. Beloved by customers for its luxuriousness of color, texture and touch. If no other fiber comes close, it's because no other brand manufactures in-house. At DEDON, specialists and designers work side by side, continuously innovating. Never settling for less than the best.

*An ancient handcrafting tradition, thriving today.  
Inside DEDON's R&D lab in Cebu.  
A DEDON weaver begins a new project.*



*Suficientemente resistente como para soportar las condiciones más duras. Suficientemente flexible como para entrelazarse artísticamente. Suficientemente versátil como para inspirar a los principales diseñadores del mundo durante casi 30 años. Así es la fibra DEDON, estándar de calidad. Estudiada, desarrollada y fabricada en los vanguardistas centros de producción de la empresa, ubicados al norte de Alemania. Su resistencia a los rayos UVA, al agua salada, al cloro, a protectores solares y a temperaturas extremas ha sido probada en el laboratorio. Apreciada por los clientes por su abundancia de colores, texturas y tactos. Si ninguna otra fibra se acerca a ella, es porque ninguna otra marca la fabrica internamente. En DEDON, especialistas y diseñadores trabajan codo con codo para innovar constantemente. Nunca se conforman con menos, siempre aspiran a lo mejor.*





And when DEDON is sure that each new batch of fiber is the best? It sends the fiber to Cebu Island, Philippines, the company's home away from home. DEDON went to Cebu for the talent of the weavers, but it stayed for the smiles, the culture, the way of life. The company set up a manufacturing facility. Certified it to the highest international standards. Invested in training, health, education. And today? Cebu is the site of DEDON's high-tech R&D lab. Its aluminum-frame production. Its quality control program. Its international logistics center. And of course, its master weavers, whose skills are reflected in woven patterns of incomparable intricacy, artistry and innovation.

*¿Y cuándo se sabe que cada nuevo lote de fibra es el mejor? DEDON lo manda a la isla de Cebú, en Filipinas, la sede de la compañía lejos de casa. DEDON acudió a Cebú por el talento de sus tejedores y se quedó allí por las sonrisas de la gente, la cultura y el estilo de vida. La empresa montó allí un centro de producción. Lo certificó conforme a los estándares internacionales más elevados. Invertió en formación, salud y educación. ¿Y hoy? Cebú es la sede del laboratorio de I+D de alta tecnología de DEDON, la fábrica de bastidores de aluminio, donde se implementa el programa de control de calidad, el centro de logística internacional y, por supuesto, donde se encuentran los maestros tejedores, cuya destreza se refleja en los diseños trenzados de una complejidad, maestría e innovación sin precedentes.*



*An AHNDA chair by Stephen Burks nears completion. Taking a break at DEDON's production facility in Cebu. DEDON's aluminum frames are precision-welded by hand.*



Manufactured entirely in house, each new piece of handwoven DEDON furniture is the embodiment of modern technology and centuries-old craftsmanship.







Almost 30 years ago, DEDON launched an outdoor revolution. Innovative by nature, the company never looked back. This is its journey — to explore, discover and enjoy life outdoors.

DEDON was founded on innovation. The story begins with a groundbreaking fiber, luxurious to the touch yet tough enough to withstand the most extreme conditions. DEDON took this fiber to the Philippines, where master weavers could bring the company's vision of luxury outdoor furniture to life. What followed was a revolution in outdoor living: DEDON began to work with world-renowned designers. It built factories for fiber and furniture production. It created icons of modern design, from circular sun beds such as ORBIT to cocoon-like hanging pods such as NESTREST. It extended its reach to more than 100 countries worldwide.

Since the beginning, DEDON has been a platform for bringing people together outdoors. The company was born out of a love of nature, a willingness to think differently and an obsession with quality. The point was never to meet the old standards; it was to create the new ones. Almost 30 years and more than 800 employees later, not much has changed. DEDON is a company of innovators and trend-setters, passionate about good design and curious by nature. As thrilled about the latest products as it was about the very first ones. It travels the world, drawing inspiration and sharing it — the journey of exploration and discovery never ends.

*DEDON se fundó sobre el principio de la innovación. La historia comienza con una fibra revolucionaria, agradable al tacto pero suficientemente dura para resistir las condiciones climáticas más extremas. DEDON llevó esa fibra a Filipinas, donde los maestros tejedores podían dar vida a la visión de la empresa de dar vida a muebles de lujo para el exterior. Lo que siguió fue una revolución en el mundo al aire libre: DEDON empezó a trabajar con diseñadores reconocidos a nivel mundial. Construyó fábricas para la producción de fibra y muebles. Creó iconos de diseño moderno, desde tumbonas circulares como ORBIT a cápsulas colgantes en forma de capullo como NESTREST. Se expandió a más de 100 países mundial.*

*Desde el inicio, DEDON ha sido una plataforma que une a las personas al aire libre. La empresa nació de su pasión por la naturaleza, de sus ganas de pensar diferente y de su obsesión por la calidad. Nunca se trató de cumplir con los viejos estándares, se crearon nuevos. Casi 30 años y más de 800 empleados más tarde, las cosas no han cambiado mucho. DEDON es una empresa de innovadores y pioneros, apasionados por el buen diseño y curiosos por la naturaleza. Igual de entusiasmados con los últimos productos como los primeros. Recorre el mundo, se inspira y comparte: el viaje de la exploración y descubrimiento nunca termina.*



# ALL MATERIALS

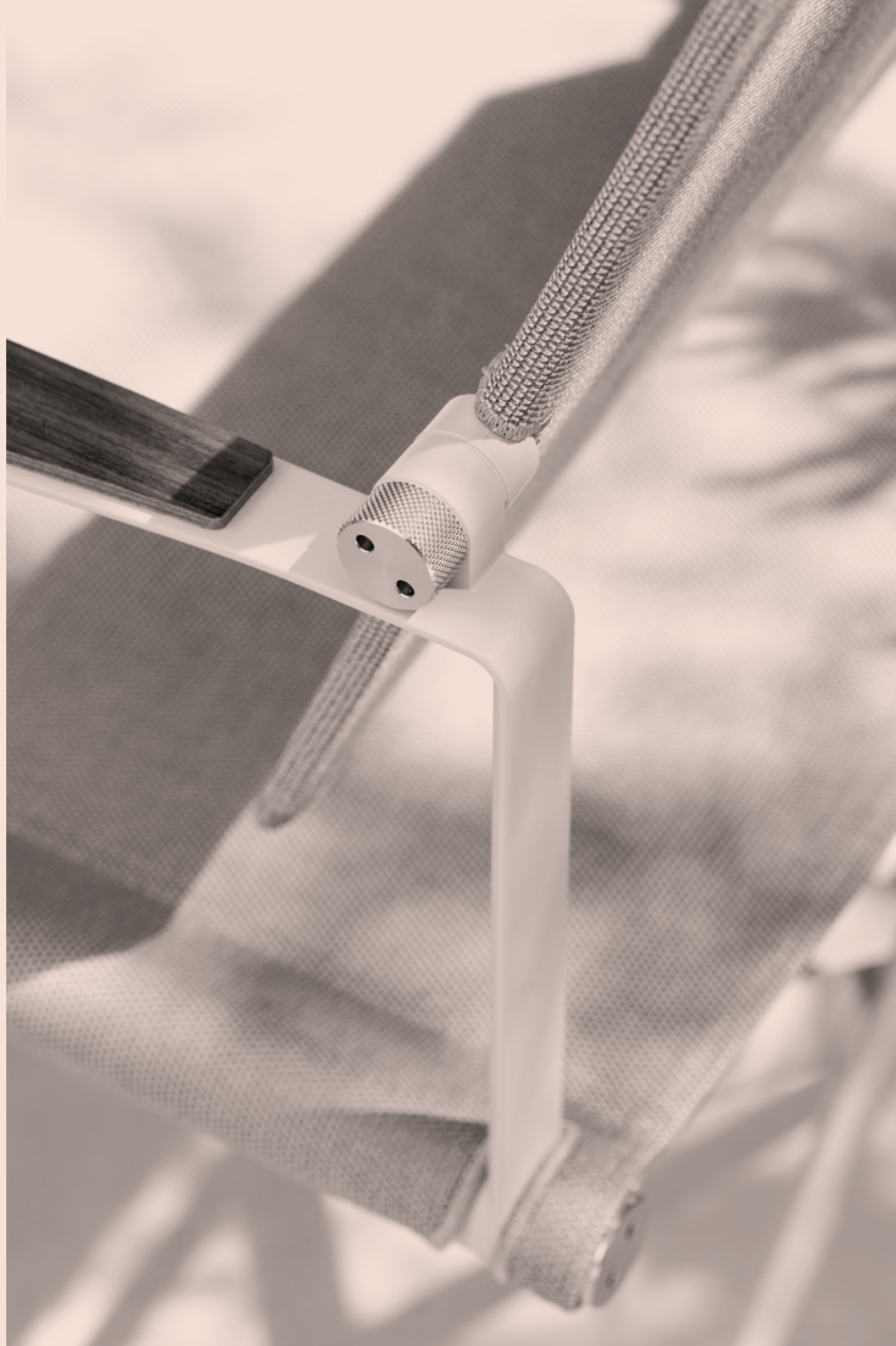

DEDON selects only the finest materials for its luxury outdoor furniture. Rain or shine, heat or cold, salt water or chlorine, DEDON has the right offer for every ambience.

SEAX's precision-engineered aluminum frame.  
DEDON Fiber combined with premium teak.



DEDON specializes in more than fiber and furniture production. Its expertise extends to outdoor spaces of all kinds, from covered terraces to sandy beaches to extreme wilderness. Every collection has its own needs and context. DEDON knows the right materials to suit it.

DEDON works exclusively with suppliers who share its passion for excellence. Only this can ensure the highest standards of quality. The company sources its premium teak from certified sustainable plantations primarily in Indonesia; its rope, upholstery and ceramics come from traditional Italian manufacturers. For fabrics and sling materials, DEDON partners with the leading ateliers in Italy, Belgium and the US.

For customers, DEDON's expertise and obsession with quality means one thing: You can enjoy life outdoors at its best. Guaranteed.

*DEDON es especialista en mucho más aparte de en la fabricación de fibra y mobiliario. Su experiencia abarca espacios exteriores de todo tipo, desde terrazas cubiertas a playas de arena y entornos naturales totalmente salvajes. Cada colección tiene sus propias necesidades y su propio contexto. DEDON sabe cuáles son los materiales acertados para cada uno de ellos.*

*DEDON colabora exclusivamente con proveedores que comparten la misma pasión por la excelencia. Solo así se pueden garantizar unos altos estándares de calidad. La compañía obtiene teca de primera calidad de plantaciones sostenibles certificadas ubicadas en por ejemplo Indonesia; la cuerda, tapicería y cerámica proceden de productores tradicionales italianos. Para los tejidos y materiales Sling, DEDON trabaja con los principales talleres de Italia, Bélgica y los Estados Unidos.*

*Para los clientes, la experiencia y obsesión por la calidad de DEDON significa una cosa: Poder disfrutar de la vida al aire libre al máximo. Garantizado.*





**CERAMICS** DEDON ceramics are produced using traditional and industrial techniques. They are non-absorbent and highly resistant to abrasion, indirect tensile stress, UV rays and the cold. DEDON ceramic tabletops are made from specially-cut mineral slabs. They are pore-free and twice as strong as glass.

**CERÁMICA** La cerámica DEDON se fabrica mediante métodos tradicionales e industriales. Es antiabsorbente y muy resistente a la abrasión, a la presión indirecta, a los rayos UVA y al frío. Los tableros de cerámica DEDON están compuestos por placas minerales especialmente cortadas. No contienen poros y son el doble de fuertes que el vidrio.



**UPHOLSTERY, CUSHIONS AND FABRICS** All DEDON fabric styles are specially woven and coated to be water-repellent, UV-resistant, stain-resistant, quick-drying and easy to maintain. DEDON cushion cores are surrounded by a water-repellent, breathable, spun-bonded wrap. DEDON upholstery incorporates all of these protections as well.

**RELLENOS, COJINES Y TEJIDOS** Todos los estilos de tejido DEDON han sido especialmente trenzados y recubiertos para que sean impermeables, resistentes a los rayos UVA y a las manchas, para que sequen rápidamente y para que resulten fáciles de cuidar. Los núcleos de los cojines DEDON están rodeados de una capa no tejida, impermeable y transpirable. La tapicería DEDON incorpora también todas estas protecciones.

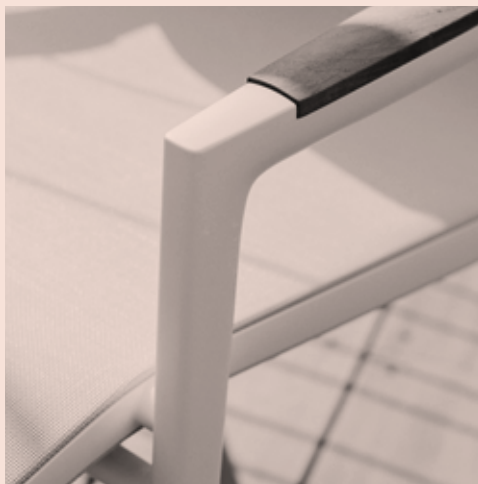

**SLING AND ALUMINUM** DEDON sling material is water-repellent, UV-resistant, mould-resistant, flame-retardant, acoustically absorbent, light-stable and able to withstand extreme working temperatures. DEDON aluminum components are specially powder-coated to protect against corrosion, abrasion and weather extremes.

**MATERIALES SLING Y ALUMINIO** Los materiales Sling de DEDON son impermeables, resistentes a los rayos UVA y al moho, ignífugos, acústicamente absorbentes, resistentes a la influencia de la luz y también capaces de soportar temperaturas de procesamiento extremas. Los componentes de aluminio DEDON están revestidos con pintura en polvo para protegerlos de la corrosión, la abrasión y condiciones climáticas extremas.

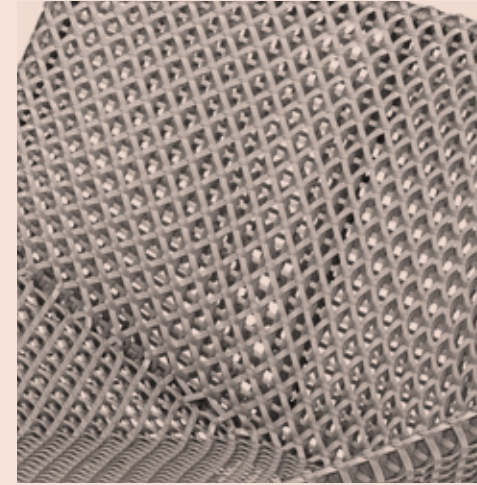

**FIBER** DEDON Fiber is produced entirely in-house to the highest standards of quality. It is unrivaled for strength, color-fastness and durability in even the most extreme weather conditions. DEDON lab technicians test every new fiber profile for resistance to UV rays, saltwater, pool water, extremes of temperature, and more.

**FIBRA** La fibra DEDON es de desarrollo propio y se fabrica conforme a los estándares de calidad más elevados. Su calidad, inalterabilidad cromática y resistencia incluso en las condiciones climáticas más extremas resultan inigualables. Los técnicos del laboratorio de DEDON analizan cada nuevo perfil de fibra para comprobar su resistencia a los rayos UVA, al agua salada, al agua de la piscina, a temperaturas extremas, etc.



**TEAK** DEDON uses only premium teak sourced from sustainable plantations. It is rich with natural tannin oils and requires no additional surface protection. It offers great durability in extreme weather conditions. It resists wetness, sudden temperature changes and prolonged exposure to sun and cold. It acquires a beautiful silver-gray patina when left to weather naturally.

**TECA** DEDON solo usa teca de primera calidad procedente de plantaciones sostenibles. Es rica en aceites taninos naturales, por lo que no precisa ninguna protección adicional para la superficie. Resulta muy duradera en condiciones meteorológicas extremas. Es resistente a la humedad, a cambios de temperatura repentinos y a una exposición prolongada al sol y al frío. Si se somete a condiciones meteorológicas naturales, adquiere una hermosa pátina de color gris plateado.



PRODUCTS  
BY  
CATEGORY





# DINING CHAIRS

AIIR Design by GAMFRATESI  
Pages 4, 50–57, 121 | 144–149



SEASHELL Design by JEAN-MARIE MASSAUD  
Pages 230–233



TIBBO Design by EDWARD BARBER & JAY OSGERBY  
Pages 32–33 | 254–259



MBRACE Design by SEBASTIAN HERKNER  
Pages 20–21 | 192–199



SEAX Design by JEAN-MARIE MASSAUD  
Pages 58–59 | 234–239



DEAN Design by JEAN-MARIE MASSAUD  
Pages 36–38 | 174–175



# BARSTOOLS

PLAY WITH DEDON Design by PHILIPPE STARCK & EUGENI QUITLET  
Pages 96–97, 295 | 214–217



TANGO Design by RICHARD FRINIER  
Pages 84 | 250–253



SEASHELL Design by JEAN-MARIE MASSAUD  
Pages 230–233



PANAMA Design by RICHARD FRINIER  
Pages 210–213



PANAMA Design by RICHARD FRINIER  
Pages 80 | 210–213



BARCELONA Design by RICHARD FRINIER  
Pages 82–83, 291 | 152–155





# TABLES

MBRACE

Design by SEBASTIAN HERKNER

Pages 20–21, 80 | 192–199



PANAMA / BARCELONA

Design by RICHARD FRINIER

Pages 291 | 210–213 | 152–155



SATELLITE

Design by JEAN-MARIE MASSAUD

Pages 228–229



TIBBO

Design by EDWARD BARBER & JAY OSGERBY

Pages 32–33 | 254–259



TANGO

Design by RICHARD FRINIER

Pages 250–253



WA

Design by TOAN NGUYEN

Pages 52–53 | 262–265



TABLETOPS (DINING TABLES)

GLASS



TEAK



SEAX

Design by JEAN-MARIE MASSAUD

Pages 54–59, 61–63 | 234–239





# LOUNGING

BREA Design by EDWARD BARBER & JAY OSGERBY  
Pages 8–13 | 156–163



MU Design by TOAN NGUYEN  
Pages 64–67, 296 | 200–205



SEASHELL Design by JEAN-MARIE MASSAUD  
Pages 86 | 230–233



MBRACE Design by SEBASTIAN HERKNER  
Pages 14–19, 283 | 192–199



TIBBO Design by EDWARD BARBER & JAY OSGERBY  
Pages 28–29, 34–35, 292 | 254–259



BRIXX Design by LORENZA BOZZOLI  
Pages 68–73, 302 | 164–169



AHNDÁ Design by STEPHEN BURKS  
Pages 98–101 | 140–143



DALA Design by STEPHEN BURKS  
Pages 24–27 | 170–173



RAYN Design by PHILIPPE STARCK  
Pages 92–95 | 220–227



LOUNGE Design by FRANK LIGTHART  
Pages 76–79, 105 | 182–189



BARCELONA Design by RICHARD FRINIER  
Pages 152–155



TANGO DESIGN BY RICHARD FRINIER  
Pages 250–253



LOU Design by TOAN NGUYEN  
Pages 88–91 | 176–181



SLIM LINE Design by JEAN-MARIE MASSAUD  
Pages 40–41 | 242–245



ORBIT & ORBIT XXL Design by RICHARD FRINIER  
Pages 44 | 208–209



SWINGREST Design by DANIEL POUZET  
Pages 46 | 246–249



TIGMI Design by JEAN-MARIE MASSAUD  
Pages 48 | 260–261





# LOUNGE CHAIRS

BRIXX Design by LORENZA BOZZOLI  
Pages 164–169



BREA Design by EDWARD BARBER & JAY OSGERBY  
Pages 10–13, 299 | 156–163



SEAX Design by JEAN-MARIE MASSAUD  
Pages 58–59, 64–65 | 234–239



DEAN Design by JEAN-MARIE MASSAUD  
Pages 39 | 174–175



LOUNGE Design by FRANK LIGTHART  
Pages 182–189



LOU Design by TOAN NGUYEN  
Pages 176–181



TIBBO Design by EDWARD BARBER & JAY OSGERBY  
Pages 28–29, 35, 139, 292 | 254–259



SEASHELL Design by JEAN-MARIE MASSAUD  
Pages 86 | 230–233



MU Design by TOAN NGUYEN  
Pages 200–205



MBRACE Design by SEBASTIAN HERKNER  
Pages 14–19, 283 | 192–199



SWINGREST Design by DANIEL POUZET  
Pages 246–249



SLIM LINE Design by JEAN-MARIE MASSAUD  
Pages 242–245



AHNDÁ Design by STEPHEN BURKS  
Pages 98–101 | 140–143



DALA Design by STEPHEN BURKS  
Pages 24–27 | 170–173



TANGO Design by RICHARD FRINIER  
Pages 250–253



PANAMA Design by RICHARD FRINIER  
Pages 210–213



BARCELONA Design by RICHARD FRINIER  
Pages 82 | 152–155





# BEACH CHAIRS

RAYN Design by PHILIPPE STARCK  
Pages 220–227



MU Design by TOAN NGUYEN  
Pages 64–65 | 200–205



SLIM LINE Design by JEAN-MARIE MASSAUD  
Pages 242–245



LOU Design by TOAN NGUYEN  
Pages 176–181



SEASHELL Design by JEAN-MARIE MASSAUD  
Pages 230–233



BARCELONA Design by RICHARD FRINIER  
Pages 152–155



SEAYOU Design by JEAN-MARIE MASSAUD  
Pages 74, 90 | 240–241



MBRACE Design by SEBASTIAN HERKNER  
Pages 22–23 | 192–199



LOUNGE Design by FRANK LIGTHART  
Pages 182–189



PANAMA Design by RICHARD FRINIER  
Pages 210–213



TANGO Design by RICHARD FRINIER  
Pages 250–253



TIBBO Design by EDWARD BARBER & JAY OSGERBY  
Pages 30–31 | 254–259





# SIDE TABLES

MBRACE Design by SEBASTIAN HERKNER  
Pages 6, 78 | 192-199



BREA Design by EDWARD BARBER & JAY OSGERBY  
Pages 8-13 | 156-163



SATELLITE Design by JEAN-MARIE MASSAUD  
Pages 58-59 | 228-229



MANGROVE Design by EOOS  
Pages 98-101 | 190-191



BRIXX Design by LORENZA BOZZOLI  
Pages 68-69, 72-73 | 164-169



BABYLON Design by HARRY-PAUL  
Pages 64-65 | 150-151



RAYN Design by PHILIPPE STARCK  
Pages 94-95 | 220-227



LOUNGE Design by FRANK LIGTHART  
Pages 76-77 | 182-189



MU Design by TOAN NGUYEN  
Pages 64-65 | 200-205



PORCINI Design by LORENZA BOZZOLI  
Pages 70-71 | 218-219



AHNDA Design by STEPHEN BURKS  
Pages 98-99 | 140-143



LOU Design by TOAN NGUYEN  
Pages 88-91 | 176-181



TANGO Design by RICHARD FRINIER  
Pages 250-253



SEASHELL Design by JEAN-MARIE MASSAUD  
Pages 230-233



TIBBO Design by EDWARD BARBER & JAY OSGERBY  
Pages 28-30 | 254-259



DALA Design by STEPHEN BURKS  
Pages 24-27 | 170-173



PANAMA Design by RICHARD FRINIER  
Pages 210-213



SLIM LINE Design by JEAN-MARIE MASSAUD  
Pages 40-41 | 242-245



BARCELONA Design by RICHARD FRINIER  
Pages 152-155





# ICONICS

TIGMI

Design by JEAN-MARIE MASSAUD

Pages 48 | 260-261



NESTREST

Design by DANIEL POUZET & FRED FRETY

Pages 42 | 206-207



ORBIT & ORBIT XXL

Design by RICHARD FRINIER

Pages 44 | 208-209



SWINGREST

Design by DANIEL POUZET

Pages 46 | 246-249





# LIGHTING

THE OTHERS Design by STEPHEN BURKS  
Pages 28–29, 76–77, 102–103, 105 | 268–271



BABYLON Design by HARRY-PAUL  
Pages 105 | 274–275



LOON Design by SEBASTIAN HERKNER  
Pages 104, 267 | 272–273



# ACCESSORIES

BABYLON PLANTER Design by HARRY-PAUL  
Pages 276



PARASOL Design by DEDON DESIGN STUDIO  
Pages 280–281



LA MALLE Design by LORENZA BOZZOLI & THE KINGS  
Page 301



DALA PLANTER & LANTERN Design by STEPHEN BURKS  
Pages 18–19 | 278–279



VID Design by DEDON DESIGN STUDIO  
Pages 28–29 | 277



DECO CUSHIONS Design by DEDON DESIGN STUDIO  
Page 301





PRODUCTS  
BY  
COLLECTION







Lounge chair  
2-seater  
Cushion: TABRIZ taupe/gray 567  
Coffee table ø 82 cm

WING CHAIR  
Hochlehner  
Sillón orejero  
Poltrona con schienale alto  
Fauteuil bergère  
18 kg 1 m³



070006

070006105



070006105



070006106



070006108

SEAT CUSHION  
Sitzkissen  
Cojín de asiento  
Cuscino seduta  
Coussin d'assise  
81 x 77 cm

HEADREST CUSHION  
Nackenkissen  
Cojín reposacabezas  
Cuscino poggiatesta  
Coussin repose-tête  
32 x 30 cm

DECO CUSHION  
Dekokissen  
Cojín de decoración  
Cuscino decorativo  
Coussin déco  
50 x 50 cm

DECO CUSHION  
Dekokissen  
Cojín de decoración  
Cuscino decorativo  
Coussin déco  
40 x 40 cm

95070007

95070006

2x 95050082

1x 95050081

56070006000

SEAT CUSHION  
Sitzkissen  
Cojín de asiento  
Cuscino seduta  
Coussin d'assise  
81 x 77 cm

HEADREST CUSHION  
Nackenkissen  
Cojín reposacabezas  
Cuscino poggiatesta  
Coussin repose-tête  
32 x 30 cm

BACK CUSHION  
Rückenkissen  
Cojín de respaldo  
Cuscino schienale  
Coussin de dossier  
76 x 38 cm

DECO CUSHION  
Dekokissen  
Cojín de decoración  
Cuscino decorativo  
Coussin déco  
40 x 40 cm

95070007

95070006

95070008

1x 95050081

HEADREST CUSHION  
Nackenkissen  
Cojín reposacabezas  
Cuscino poggiatesta  
Coussin repose-tête  
32 x 30 cm

95070009

HEADREST CUSHION  
Nackenkissen  
Cojín reposacabezas  
Cuscino poggiatesta  
Coussin repose-tête  
32 x 30 cm

95070009

**EN** Regardless of the choice of fabric color, the headrest cushion of the AHNDA Wingchair is always sewn with a special thread that picks up the essential color of the furniture.

**DE** Unabhängig von der Wahl der Stofffarbe wird das Nackenkissen des AHNDA Hochlehners immer mit einem besonderen Faden genäht, welcher die Grundfarbe des Möbelstücks aufgreift.

**ES** Independientemente de la tela que se elija, el cojín reposacabezas del sillón orejero AHNDA viene con una costura acorde con el color principal del mueble.

**IT** Indipendentemente dal colore del rivestimento scelto, le cuciture del cuscino poggiatesta della poltrona con schienale alto AHNDA sono effettuate con filo speciale, che riprende il colore base del mobile.

**FR** Quelle soit la couleur choisie, le coussin repose-tête du fauteuil bergère AHNDA est toujours cousu avec un fil spécial qui reprend la couleur principale du meuble.



95070006



95070009



95070009

## Recommended combination

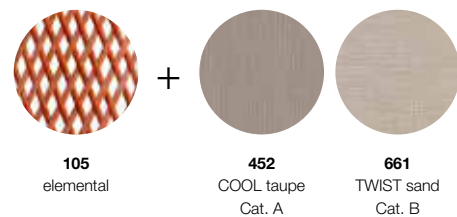

105

elemental

452

COOL taupe  
Cat. A

661

TWIST sand  
Cat. B

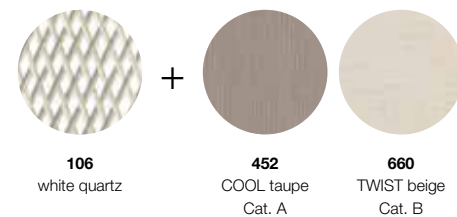

106

white quartz

452

COOL taupe  
Cat. A

660

TWIST beige  
Cat. B

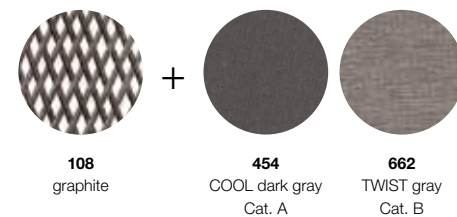

108

graphite

454

COOL dark gray  
Cat. A

662

TWIST gray  
Cat. B



LOUNGE CHAIR

Sessel  
Sillón bajo  
Poltrona club  
Fauteuil club  
12 kg 0,6 m³



070005

070005105



070005105



070005106



070005108

SEAT CUSHION  
Sitzkissen  
Cojín de asiento  
Cuscino seduta  
Coussin d'assise  
81 x 77 cm

95070007

SEAT CUSHION  
Sitzkissen  
Cojín de asiento  
Cuscino seduta  
Coussin d'assise  
81 x 77 cm

95070007

DECO CUSHION  
Dekokissen  
Cojín de decoración  
Cuscino decorativo  
Coussin déco  
50 x 50 cm

2x 95050082

BACK CUSHION  
Rückenkissen  
Cojín de respaldo  
Cuscino schienale  
Coussin de dossier  
76 x 38 cm

95070008

DECO CUSHION  
Dekokissen  
Cojín de decoración  
Cuscino decorativo  
Coussin déco  
40 x 40 cm

1x 95050081

DECO CUSHION  
Dekokissen  
Cojín de decoración  
Cuscino decorativo  
Coussin déco  
40 x 40 cm

1x 95050081



56070005000

2-SEATER  
2er-Sofa  
Sofá 2 plazas  
Divano 2 posti  
Canapé 2 places  
15 kg 1,1 m³

070012



070012105



070012105



070012106



070012108

SEAT CUSHION  
Sitzkissen  
Cojín de asiento  
Cuscino seduta  
Coussin d'assise  
154 x 81,5 cm

95070012

SEAT CUSHION  
Sitzkissen  
Cojín de asiento  
Cuscino seduta  
Coussin d'assise  
154 x 81,5 cm

95070012

BACK CUSHION  
Rückenkissen  
Cojín de respaldo  
Cuscino schienale  
Coussin de dossier  
152 x 38 cm

95070013

DECO CUSHION  
Dekokissen  
Cojín de decoración  
Cuscino decorativo  
Coussin déco  
50 x 50 cm

5x 95050082



56070012000

COFFEE TABLE / FOOTSTOOL

Kaffeetisch / Hocker  
Mesa de centro / Reposapiés  
Tavolino da salotto / Pouf  
Table de salon / Repose-pieds  
ø 82 cm  
6 kg 0,2 m³

070031



Set: 070032105



Set: 070032106



Set: 070032108

GLASS ELEMENTAL  
Glas elemental  
Sobre de cristal elemental  
Piano in vetro elemental  
Plaque en verre elemental  
9,5 kg

22270031105

GLASS LIPARI  
Glas lipari  
Sobre de cristal lipari  
Piano in vetro lipari  
Plaque en verre lipari  
9,5 kg

22270031304

GLASS VULCANO  
Glas vulcano  
Sobre de cristal vulcano  
Piano in vetro vulcano  
Plaque en verre vulcano  
9,5 kg

22270031305



070031105



070031106



070031108

SEAT CUSHION  
Sitzkissen  
Cojín de asiento  
Cuscino seduta  
Coussin d'assise  
ø 80 cm

95070031

56070031000



Tabletop Glass



105 elemental



304 lipari



305 vulcano





Armchair salt, teak base  
Cushion: COOL ash  
Side chair saffron, sled base

Recommended combinations

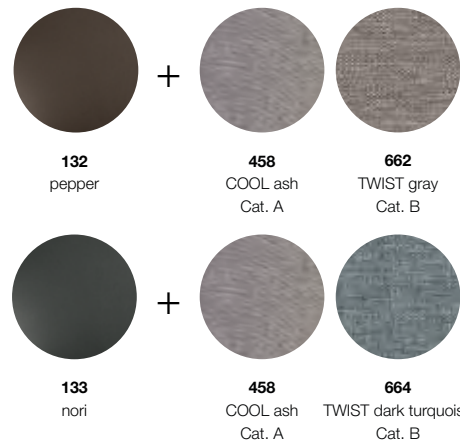
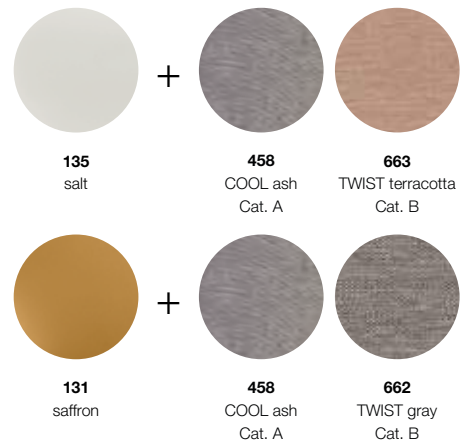

ARMCHAIR  
Armlehnstuhl  
Silla con brazos  
Poltrona pranzo  
Fauteuil repas  
6 kg 0,25 m³



301001135

SEAT CUSHION  
Sitzkissen  
Cojin de asiento  
Cuscino seduta  
Coussin d'assise  
43 x 44,5 cm

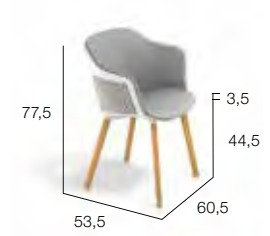

95300001

CUSHION  
Polsterauflage  
Cojin  
Cuscino  
Coussin matelassé  
43 x 44,5 cm + 59 x 35,5 cm

95300002 56300001000



307001132



308001131



309001133

ARMCHAIR  
Armlehnstuhl  
Silla con brazos  
Poltrona pranzo  
Fauteuil repas  
6,4 kg 0,25 m³



301002135

SEAT CUSHION  
Sitzkissen  
Cojin de asiento  
Cuscino seduta  
Coussin d'assise  
43 x 44,5 cm

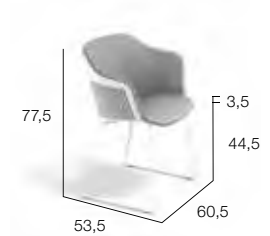

95300001

CUSHION  
Polsterauflage  
Cojin  
Cuscino  
Coussin matelassé  
43 x 44,5 cm + 59 x 35,5 cm

95300002 56300001000



307002132



ARMCHAIR  
Armlehnstuhl  
Silla con brazos  
Poltrona pranzo  
Fauteuil repas  
6,4 kg 0,25 m<sup>3</sup>



308002131

SEAT CUSHION  
Sitzkissen  
Cojín de asiento  
Cuscino seduta  
Coussin d'assise  
43 x 44,5 cm

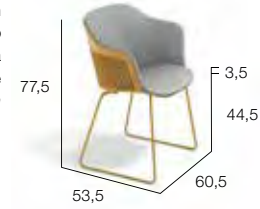

95300001

CUSHION  
Polsterauflage  
Cojín  
Cuscino  
Coussin matelassé  
43 x 44,5 cm + 59 x 35,5 cm



95300002 56300001000



309002133



SIDE CHAIR  
Esstuhl  
Silla de comedor  
Sedia pranzo  
Chaise repas  
5,4 kg 0,22 m<sup>3</sup>



301003135

SEAT CUSHION  
Sitzkissen  
Cojín de asiento  
Cuscino seduta  
Coussin d'assise  
43 x 44,5 cm

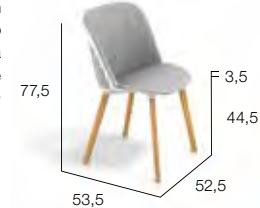

95300001

CUSHION  
Polsterauflage  
Cojín  
Cuscino  
Coussin matelassé  
43 x 44,5 cm + 54,5 x 35,5 cm



95300003 56300003000



307003132



308003131



309003133

SIDE CHAIR  
Esstuhl  
Silla de comedor  
Sedia pranzo  
Chaise repas  
5,8 kg 0,22 m<sup>3</sup>



301004135

SEAT CUSHION  
Sitzkissen  
Cojín de asiento  
Cuscino seduta  
Coussin d'assise  
43 x 44,5 cm

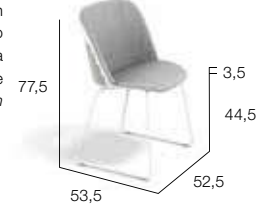

95300001

CUSHION  
Polsterauflage  
Cojín  
Cuscino  
Coussin matelassé  
43 x 44,5 cm + 54,5 x 35,5 cm



95300003 56300003000



307004132



308004131



309004133

**EN** The seats of the AIIR armchairs and side chairs consist of injection-molded polypropylene, while the bases are made of premium teak or powder coated stainless steel, which we recommend cleaning periodically to prevent stains. Clean teak base with warm water in which natural soap flakes have been dissolved.

**DE** Die Sitzschalen der Sessel und Stühle der AIIR-Reihe werden im Spritzgussverfahren aus Polypropylen hergestellt. Die Untergestelle bestehen aus Premium-Teak oder pulverbeschichtetem Edelstahl. Wir empfehlen eine regelmäßige Reinigung des Untergestells, um Fleckenbildung zu vermeiden. Das Teak-Gestell mit warmem Wasser reinigen, in dem natürliche Seifenflocken vollständig aufgelöst wurden.

**ES** Los asientos de los sillones y de las sillas AIIR están hechos de polipropileno moldeado por inyección mientras que las bases están elaboradas con teca de primera calidad o acero inoxidable revestido de pintura en polvo, el cual recomendamos limpiar periódicamente para prevenir manchas. Lavar las patas de teca con agua templada y jabón natural en copos bien disueltos.

**IT** Le sedute delle sedie AIIR sono realizzate in polipropilene con il metodo di stampaggio a iniezione. I telai sono in teak di categoria premium o in acciaio inox verniciato a polvere. Consigliamo di pulire con regolarità il telaio metallico per evitare la presenza di macchie. Il modo migliore per pulire il teak è usare acqua tiepida con l'aggiunta di sapone neutro che non danneggi il materiale.

**FR** Les sièges des fauteuils et des chaises AIIR sont composés de polypropylène moulé par injection, tandis que les bases sont en teck de qualité supérieure ou en acier inoxydable avec revêtement poudré, que nous recommandons de nettoyer régulièrement pour éviter l'apparition de taches. Nettoyez la base en teck avec de l'eau chaude dans laquelle ont été dissous des copeaux de savon naturel.



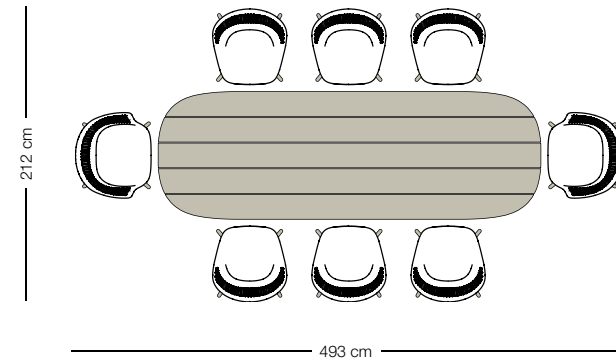

**AIIR + MBRACE Setting**

- 1x 085055205 – MBRACE dining table
- 2x 301001135 – AIIR armchair, salt
- 6x 301003135 – AIIR side chair, salt

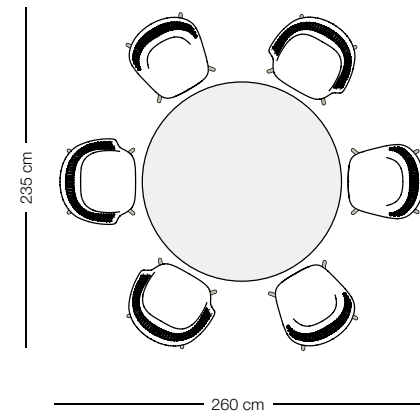

**AIIR + SEAX Setting**

- 1x 701046204 – SEAX dining table, white/white
- 3x 308001131 – AIIR armchair, saffron
- 3x 308003131 – AIIR side chair, saffron

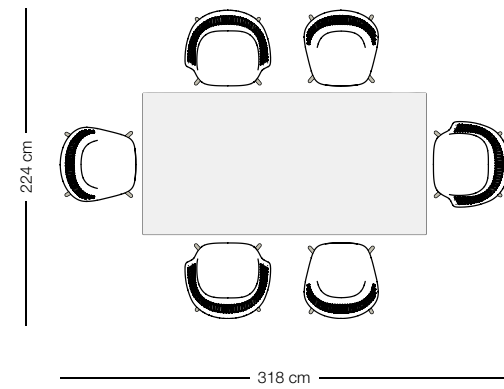

**AIIR + WA Setting**

- 1x 601071001 – WA dining table, white/HPL
- 3x 301001135 – AIIR armchair, salt
- 3x 301003135 – AIIR side chair, salt



MBRACE dining table 270 x 90 cm  
AIIR armchairs, salt



# BABYLON SIDE TABLE

Design by HARRY-PAUL

**EN** Made of Monolite Ipergres®: Frost proof, non-absorbing ceramic material with excellent resistance to scratches, abrasion and indirect tensile stress. Due to method of production, the side table does not have an entirely flat surface. BABYLON PE consists of rotomolded polyethylene: easy to maintain, 100% recyclable, light yet robust at the same time.

**DE** Aus Monolite Ipergres®: ein frostsicheres, wasserabweisendes Keramikmaterial mit ausgezeichneter Kratz- und Abriebfestigkeit. Aus produktionstechnischen Gründen hat der Beistelltisch keine vollständig glatte Oberfläche. BABYLON PE ist aus rotationsguss-gefertigtem Polyethylen hergestellt: einfach zu pflegen, gleichzeitig leicht und widerstandsfähig, 100% recyclingfähig.

**ES** Fabricado en Monolite Ipergres® es un material cerámico resistente a las heladas y hermético al agua, con una resistencia excelente contra los arañazos, la abrasión así como a la presión indirecta. Debido a su método de producción, las mesas auxiliares no tienen una superficie completamente regular. BABYLON PE: Fabricado en polietileno rotomoldeado (PE). De fácil mantenimiento, ligero y al mismo tiempo resistente, 100% reciclable.

**IT** Fabricato in Monolite Ipergres®: un materiale ceramico resistente al gelo, non assorbente con una resistenza eccellente ai graffi e alle abrasioni. A causa del metodo di produzione, il tavolino non presenta una superficie completamente liscia. BABYLON PE: Fabricato in polietilene rotostampato. Di facile manutenzione, leggero e allo stesso tempo resistente, 100% riciclabile.

**FR** En Monolite Ipergres® : matériau céramique résistant au gel, imperméable et hautement résistant aux contraintes de traction indirectes, aux rayures et à l'abrasion. En raison des méthodes de production, la surface de la table d'appoint n'est pas complètement plane. BABYLON PE: En Polyéthylène (PE) rotomoulé. Facile d'entretien, à la fois léger et résistant. 100% recyclable.



Side table ceramic

## Material

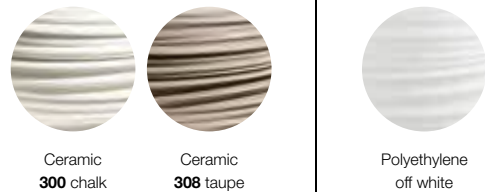

STOOL / SIDE TABLE CERAMIC  
 Hocker / Beistelltisch Keramik  
 Asiento / Mesa auxiliar de cerámica  
 Pouf / Tavolino ceramica  
 Tabouret / Table d'appoint en céramique  
**ø 52,5 cm**  
 17 kg 0,12 m³



053089**300**



053089**308**

STOOL / SIDE TABLE PE  
 Hocker / Beistelltisch PE  
 Asiento / Mesa auxiliar de PE  
 Pouf / Tavolino PE  
 Tabouret / Table d'appoint PE  
**ø 52,5 cm**  
 5 kg 0,12 m³

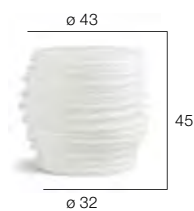

05311**1000**







Armchair  
Cushion: COOL white

## Recommended combinations

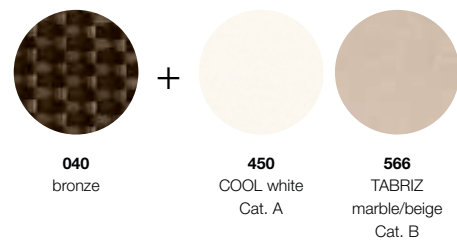

ARMCHAIR  
Armlehnstuhl  
Silla con brazos  
Poltrona pranzo  
Fauteuil repas  
7 kg 0,34 m<sup>3</sup>



027001040

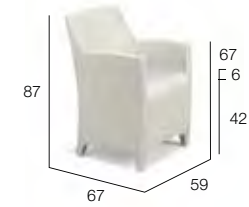

027001083

SEAT CUSHION  
Sitzkissen  
Cojín de asiento  
Cuscino seduta  
Coussin d'assise  
45 x 46 cm



95027001

56027001000

DINING TABLE  
Esstisch  
Mesa comedor  
Tavolo pranzo  
Table repas  
100 x 100 cm  
9,5 kg 0,75 m<sup>3</sup>



Set: 227270040



Set: 227270083

SATINATED GLASS TOP  
Satinierter Glasplatte  
Sobre de cristal satinado  
Piano in vetro satinato  
Plaque en verre satinée  
15,5 kg

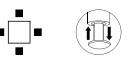

2+2



22227075000

56027076000

DINING TABLE  
Esstisch  
Mesa comedor  
Tavolo pranzo  
Table repas  
100 x 200 cm  
11 kg 1,5 m<sup>3</sup>



Set: 227120040

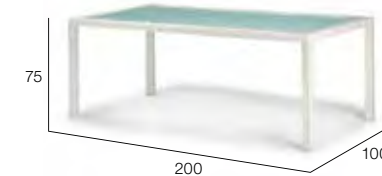

Set: 227120083

SATINATED GLASS TOP  
Satinierter Glasplatte  
Sobre de cristal satinado  
Piano in vetro satinato  
Plaque en verre satinée  
33 kg

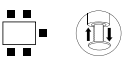

4+2



22227065000

56027066000

LOUNGE CHAIR  
Sessel  
Sillón bajo  
Poltrona club  
Fauteuil club  
10 kg 0,54 m<sup>3</sup>



027005040



027005083

SEAT CUSHION + BACK CUSHION  
Sitzkissen + Rückenkissen  
Cojín de asiento + Cojín de respaldo  
Cuscino seduta + Cuscino schienale  
Coussin d'assise + Coussin de dossier  
56 x 61 cm + 50 x 60 cm



95027005

56027005000

2-SEATER  
2er-Sofa  
Sofá 2 plazas  
Divano 2 posti  
Canapé 2 places  
15 kg 1,1 m<sup>3</sup>



027012040



027012083

2x SEAT CUSHIONS + 2x BACK CUSHIONS  
2x Sitzkissen + 2x Rückenkissen  
2x Cojines de asiento + 2x Cojines de respaldo  
2x Cuscini seduta + 2x Cuscini schienale  
2x Coussins d'assise + 2x Coussins de dossier  
2x 67 x 61 cm + 2x 50 x 60 cm



95027012

56027012000

CORNER MODULE  
Eckmodul  
Módulo esquina  
Modulo d'angolo  
Module d'angle  
11 kg 0,58 m<sup>3</sup>



027003040



027003083

SEAT CUSHION + 3x DECO CUSHIONS  
Sitzkissen + 3x Dekokissen  
Cojín asiento + 3x Cojines decoración  
Cuscino seduta + 3x Cuscini decorativo  
Coussin d'assise + 3x Coussins déco  
71 x 71 cm + 1x 40 x 60 cm + 2x 50 x 60 cm



95027003

56027003000

RECOMMENDED DECO CUSHIONS  
Empfohlene Dekokissen  
Cojines decoración recomendados  
Cuscini decorativi consigliati  
Coussins déco recommandés

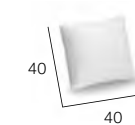

95050081



CENTER MODULE

Modul mitte  
Módulo centro  
Modulo centrale  
Module central  
9 kg 0,51 m³



027007040



027007083

SEAT CUSHION + 2x DECO CUSHIONS  
Sitzkissen + 2x Dekokissen  
Cojín de asiento + 2x Cojines de decoración  
Cuscino seduta + 2x Cuscini decorativo  
Coussin d'assise + 2x Coussins déco  
80 x 71 cm + 1x 40 x 60 cm + 1x 50 x 60 cm



027007

DAYBED LEFT

Daybed links  
Daybed izquierdo  
Daybed sinistro  
Daybed gauche  
18,5 kg 1,09 m³



027003040 + 027037040



027003083 + 027037083

SEAT CUSHION + 3x DECO CUSHIONS  
Sitzkissen + 3x Dekokissen  
Cojín de asiento + 3x Cojines decoración  
Cuscino seduta + 3x Cuscini decorativo  
Coussin d'assise + 3x Coussins déco  
151 x 80 cm + 1x 60 x 40 cm + 2x 60 x 50 cm



027003 + 027037

DAYBED RIGHT

Daybed rechts  
Daybed derecho  
Daybed destro  
Daybed droit  
18,5 kg 1,09 m³



027003040 + 027037040

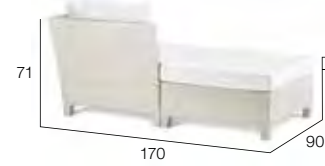

027003083 + 027037083

SEAT CUSHION + 3x DECO CUSHIONS  
Sitzkissen + 3x Dekokissen  
Cojín de asiento + 3x Cojines decoración  
Cuscino seduta + 3x Cuscini decorativo  
Coussin d'assise + 3x Coussins déco  
151 x 80 cm + 1x 60 x 40 cm + 2x 60 x 50 cm



027003 + 027037

BEACH CHAIR

Sonnenliege  
Tumbona  
Letino  
Chaise longue  
19 kg 0,6 m³



027020040

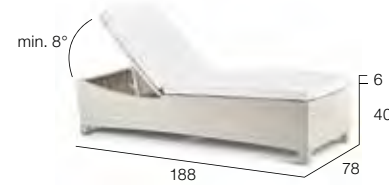

027020083

CUSHION

Kissen  
Cojines  
Cuscini  
Coussins  
78 x 187 cm



027020

FOOTSTOOL / COFFEE TABLE

Hocker / Kaffeetisch  
Reposapiés / Mesa de centro  
Pouf / Tavolino da salotto  
Repose-pieds / Table de salon  
80 x 80 cm  
7,5 kg 0,2 m³



027037040



027037083

SEAT CUSHION

Sitzkissen  
Cojín de asiento  
Cuscino seduta  
Coussin d'assise  
80 x 80 cm



027037

CLEAR GLASS TOP

Klarglasplatte  
Sobre de cristal transparente  
Piano in vetro trasparente  
Plaque en verre clair  
8,7 kg



Set: 027038040

Set: 027038083

2226082000

56027038000

Tabletops Glass



000 satinated glass  
Bottom: satinated  
BARCELONA Dining table

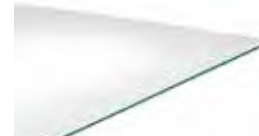

000 clear glass  
BARCELONA Coffee table

# BARCELONA

## OPTIONAL COMBINATIONS

### BARCELONA Setting 01

1x 027003 + 027037 – Daybed right, Seat cushion + 3x Deco cushion  
1x 027007 – Center module, Seat cushion + 2x Deco cushion  
1x 027038 – Coffee table incl. glass tabletop

Recommended deco cushions:  
2x 95050081 – 40 x 40 cm

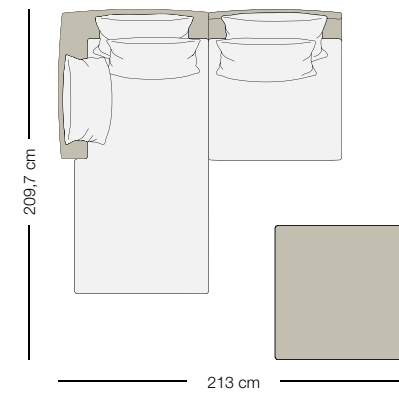

### BARCELONA Setting 02

2x 027003 – Corner module, Seat cushion + 3x Deco cushion  
1x 027007 – Center module, Seat cushion + 2x Deco cushion  
1x 027037 – Footstool 80 x 80 cm, Seat cushion  
1x 027038 – Coffee table incl. glass tabletop

Recommended deco cushions:  
3x 95050081 – 40 x 40 cm

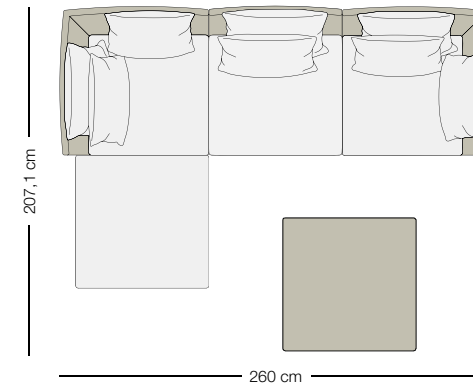

### BARCELONA Setting 03

1x 027003 – Corner module, Seat cushion + 3x Deco cushion  
4x 027007 – Center module, Seat cushion + 2x Deco cushion  
2x 027037 – Footstool 80 x 80 cm, Seat cushion  
1x 027038 – Coffee table incl. glass tabletop

Recommended deco cushions:  
5x 95050081 – 40 x 40 cm

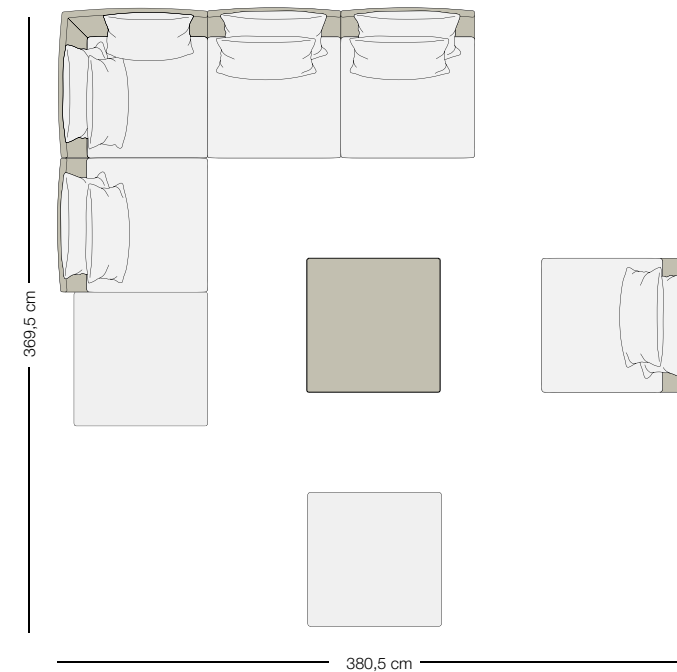













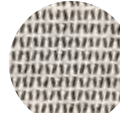





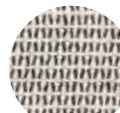

Lounge chair, white  
3-seater, white  
Cushion: PUNO reed  
Coffee table 80 x 150 cm

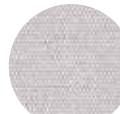
Recommended combinations

	+					
000 white		452 COOL taupe Cat. A	661 TWIST sand Cat. B	678* KVADRAT patio450 Cat. B	696 PUNO reed Cat. C	693** SAIL CLOTH light gray Cat. B
	+					
317 black pepper		452 COOL taupe Cat. A	661 TWIST sand Cat. B	680* KVADRAT patio370 Cat. B	696 PUNO reed Cat. C	693** SAIL CLOTH light gray Cat. B
	+					
330 palm		452 COOL taupe Cat. A	661 TWIST sand Cat. B	675* KVADRAT patio220 Cat. B	695 PUNO straw Cat. C	693** SAIL CLOTH light gray Cat. B

LOUNGE CHAIR  
Sessel  
Sillón bajo  
Poltrona club  
Fauteuil club  
24 kg 0,8 m³

317  
330



107001000

CUSHION SET  
Kissenset  
Set de cojines  
Set di cuscini  
Set de coussins



95107001 56107001000

2-SEATER  
2er-Sofa  
Sofá 2 plazas  
Divano 2 posti  
Canapé 2 places  
38 kg 1,4 m³

317  
330



107011000

CUSHION SET  
Kissenset  
Set de cojines  
Set di cuscini  
Set de coussins

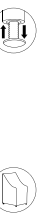

95107011 56107011000

3-SEATER  
3er-Sofa  
Sofá 3 plazas  
Divano 3 posti  
Canapé 3 places  
53,5 kg 2 m³

317  
330

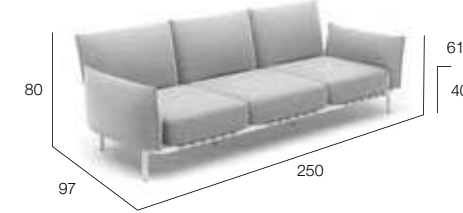

107021000

CUSHION SET  
Kissenset  
Set de cojines  
Set di cuscini  
Set de coussins



95107021 56107021000

DAYBED LEFT  
Daybed links  
Daybed izquierdo  
Daybed sinistro  
Daybed gauche  
37 kg 1,4 m³

317  
330



107041000

CUSHION SET  
Kissenset  
Set de cojines  
Set di cuscini  
Set de coussins



95107041 56107041000

DAYBED RIGHT  
Daybed rechts  
Daybed derecho  
Daybed destro  
Daybed droit  
37 kg 1,4 m³

317  
330



107042000

CUSHION SET  
Kissenset  
Set de cojines  
Set di cuscini  
Set de coussins



95107042 56107042000

RECOMMENDED DECO CUSHIONS  
Empfohlene Dekokissen  
Cojines decoración recomendados  
Cuscini decorativi consigliati  
Coussins déco recommandés

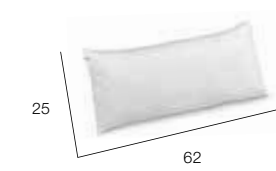

95050090

\* EN See page 298 for overview KVADRAT Fabrics.

DE Siehe Seite 298 für die Übersicht der KVADRAT Stoffe.

ES Consulta la página 298 para el resumen de precios de los cojines decorativos.

IT Vai alla pagina 298 per una panoramica dei tessuti KVADRAT.

FR Voir page 298 pour un récapitulatif des tissus KVADRAT.

\*\* EN Fabrics for BREA Collection and deco cushions only.

DE Stoffe nur für BREA Kollektion und Dekokissen erhältlich.

ES Solo para la colección BREA y los cojines decorativos.

IT Tessuto disponibile solo per la collezione BREA e per i cuscini decorativi.

FR Tissu uniquement disponible pour la collection BREA et les coussins déco.



2-SEATER DAYBED LEFT  
2er-Sofa, Daybed links  
Sofá 2 plazas con daybed izquierdo  
Divano 2 posti, daybed sinistro  
Canapé 2 places, daybed gauche  
55 kg 2,8 m<sup>3</sup>

107016

317  
330

107016000

CUSHION SET  
Kissenset  
Set de cojines  
Set di cuscini  
Set de coussins

95107016 56107016000

2-SEATER DAYBED RIGHT  
2er-Sofa, Daybed rechts  
Sofá 2 plazas con daybed derecho  
Divano 2 posti, daybed destro  
Canapé 2 places, daybed droit  
55 kg 2,8 m<sup>3</sup>

107017

317  
330

107017000

CUSHION SET  
Kissenset  
Set de cojines  
Set di cuscini  
Set de coussins

95107017 56107017000

DOUBLE DAYBED  
Doppel-Daybed  
Daybed doble  
Daybed matrimoniale  
Daybed double  
74 kg 2,65 m<sup>3</sup>

107043

317  
330

107043000

CUSHION SET  
Kissenset  
Set de cojines  
Set di cuscini  
Set de coussins

95107043 56107043000

3-SEATER DAYBED LEFT  
3er-Sofa, Daybed links  
Sofá 3 plazas con daybed izquierdo  
Divano 3 posti, daybed sinistro  
Canapé 3 places, daybed gauche  
80 kg 3,7 m<sup>3</sup>

107026

317  
330

107026000

CUSHION SET  
Kissenset  
Set de cojines  
Set di cuscini  
Set de coussins

95107026 56107026000

3-SEATER DAYBED RIGHT  
3er-Sofa, Daybed rechts  
Sofá 3 plazas con daybed derecho  
Divano 3 posti, daybed destro  
Canapé 3 places, daybed droit  
80 kg 3,7 m<sup>3</sup>

107027

317  
330

107027000

CUSHION SET  
Kissenset  
Set de cojines  
Set di cuscini  
Set de coussins

95107027 56107027000

CORNER SOFA  
Ecksofa  
Sofá esquinero  
Divano angolare  
Canapé d'angle  
106 kg 5,4 m<sup>3</sup>

107062

317  
330

107062000

CUSHION SET  
Kissenset  
Set de cojines  
Set di cuscini  
Set de coussins

95107062 56107062000

L-SOFA LEFT  
L-Sofa links  
Sofá en L izquierdo  
Divano a L, sinistro  
Canapé en L, gauche  
86 kg 3,7 m<sup>3</sup>

107060

317  
330

107060000

CUSHION SET  
Kissenset  
Set de cojines  
Set di cuscini  
Set de coussins

95107060 56107060000

L-SOFA RIGHT  
L-Sofa rechts  
Sofá en L derecho  
Divano a L, destro  
Canapé en L, droit  
86 kg 3,7 m<sup>3</sup>

107061

317  
330

107061000

CUSHION SET  
Kissenset  
Set de cojines  
Set di cuscini  
Set de coussins

95107060 56107061000

4-SEATER DAYBED LEFT  
4er-Sofa Daybed links  
Sofá 4 plazas con daybed izquierdo  
Divano 4 posti, daybed sinistro  
Canapé 4 places, daybed gauche  
97 kg 4,9 m<sup>3</sup>

107056

317  
330

107056000

CUSHION SET  
Kissenset  
Set de cojines  
Set di cuscini  
Set de coussins

95107056 56107056000

4-SEATER DAYBED RIGHT  
4er-Sofa Daybed rechts  
Sofá 4 plazas con daybed derecho  
Divano 4 posti, daybed destro  
Canapé 4 places, daybed droit  
97 kg 4,9 m<sup>3</sup>

107057

317  
330

107057000

CUSHION SET  
Kissenset  
Set de cojines  
Set di cuscini  
Set de coussins

95107057 56107057000

CORNER SOFA XL LEFT  
Ecksofa XL links  
Sofá esquinero XL izquierdo  
Divano angolare XL, angolo a sinistra  
Canapé d'angle XL, gauche  
120 kg 7,7 m<sup>3</sup>

107063

317  
330

107063000

CUSHION SET  
Kissenset  
Set de cojines  
Set di cuscini  
Set de coussins

95107063 56107063000

CORNER SOFA XL RIGHT  
Ecksofa XL rechts  
Sofá esquinero XL derecho  
Divano angolare XL, angolo a destra  
Canapé d'angle XL, droite  
120 kg 7,7 m<sup>3</sup>

107064

317  
330

107064000

CUSHION SET  
Kissenset  
Set de cojines  
Set di cuscini  
Set de coussins

95107063 56107064000



COFFEE TABLE  
Kaffeetisch  
Mesa de centro  
Tavolino da salotto  
Table de salon  
**90 x 90 cm**  
39 kg 0,29 m<sup>3</sup>



Set: 107033000

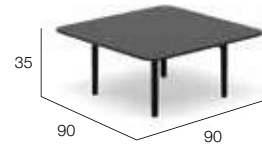

Set: 107033317



Set: 107033330



56107033000

107033

COFFEE TABLE  
Kaffeetisch  
Mesa de centro  
Tavolino da salotto  
Table de salon  
**80 x 150 cm**  
49,5 kg 0,42 m<sup>3</sup>



Set: 107035000



Set: 107035317



Set: 107035330



56107035000

107035

Combinations: Tabletop Mineral Composite

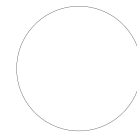

000 white

+



204 white



317 black pepper

+



203 ebony



330 palm

+



204 white

CUSHION CONSTRUCTION

SEAT CUSHION

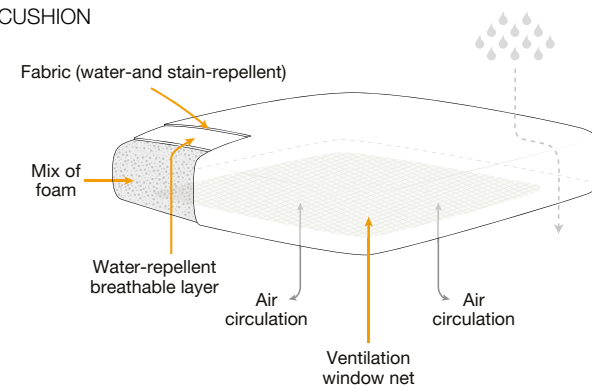

BACKREST & ARMREST

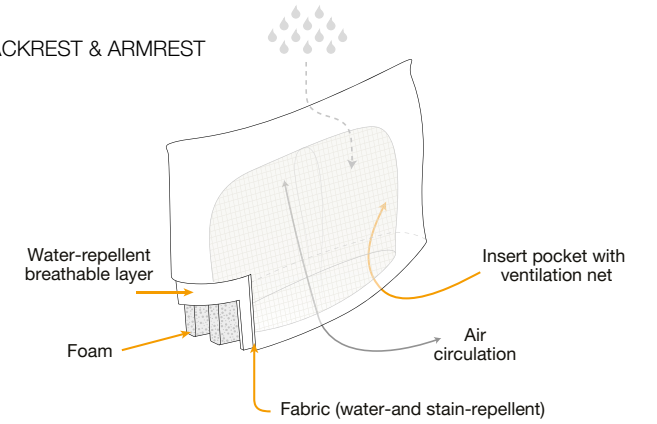

**EN** BREIA is a comfortable and clever lounging collection with thoughtfully developed upholstery for indoor and outdoor use.

BREIA cushions can be easily slipped on and off of the metal frame. They are available in Cat. A, Cat. B (incl. KVADRAT) and Cat. C fabrics. Exclusively for BREIA, cushions and deco cushions are available in sail cloth light gray fabric. Cushion covers can be removed. The cushions are protected by a water-repellent polyester covering. The fabric is treated to be stain- and water-repellent. If not used under roof or awning, we recommend covering the modules with DEDON outdoor covers at night and during rainfall. BREIA consists of a powder-coated metal frame, universal die-cast aluminum legs and connectors, and elastic outdoor belting in Sunbrella® yarns for enhanced comfort. All belting comes in a warm gray color.

The tabletop of the coffee tables and side tables consists of a self-supporting mineral-composite slab, cut by water jet from the largest premium sintered porcelain slabs available on the market. Clean the frame and tabletop with a soft cloth and warm water.

**DE** BREIA ist eine komfortable und intelligente Lounging Kollektion mit durchdachten Polster-Elementen für den Innen- und Außenbereich. Die Polster-elemente wirken fest verbaut, lassen sich bei Bedarf jedoch im Handumdrehen vom Rahmen herunternehmen. Erhältlich in Stoffen der Kategorien A, B (inklusive KVADRAT) und C, können die Kissenhüllen der Polster-elemente einfach abgezogen werden. Exklusiv erhältlich für BREIA, werden die Kissen und Dekokissen auch im Stoff sail cloth light gray angeboten. Die Kissen werden von einer wasserabweisenden Polyesterschicht geschützt. Der Stoff ist so behandelt, dass er schmutz- und wasserabweisend ist. Wenn Sie die Möbel nicht auf einer überdachten Fläche oder unter einer Markise aufstellen, empfehlen wir, die Module nachts und bei Regen mit DEDON Hussen zu schützen.

Das Gestell von BREIA besteht aus pulverbeschichteten Aludruckgussbeinen und -verbindungen sowie einem pulverbeschichteten Metallrahmen. Elastische Outdoor Riemen von Sunbrella® sorgen für noch mehr Komfort. Die Farbe der Riemen ist für alle Pulverbeschichtungen ein warmes grau. Die Tischplatten der Kaffeetische und Beistelltische bestehen aus einem freitragenden Mineralverbundmaterial, das per Wasserstrahl aus den größten am Markt erhältlichen gesinterten Porzellanplatten geschnitten wird. Reinigen Sie den Rahmen und die Tischplatten mit einem weichen Tuch und warmem Wasser.

**ES** BREIA es una colección de piezas lounge cómodas e inteligentes elaboradas con tapicería diseñada a conciencia tanto para uso interior como exterior. Los cojines BREIA pueden ponerse y quitarse fácilmente de la estructura metálica. Están disponibles en tejidos de las categorías A, B (incluyendo KVADRAT) y C. Exclusivamente para BREIA, los cojines y cojines decorativos están disponibles en la tela sail cloth light gray. Las fundas de cojín se pueden quitar. El relleno de los cojines esta protegido con un revestimiento impermeable de poliéster. La tela está tratada para ser resistente a las manchas y al agua. Si no se utiliza bajo techo o toldo, se recomienda cubrir los módulos con las fundas para exteriores DEDON por la noche y durante las lluvias.

La colección BREIA está compuesta por estructuras de metal revestidas con pintura poliéster en polvo, patas y conectores de aluminio fundido y correas elásticas para exteriores de Sunbrella®, las cuales aportan un mayor confort. Todas las correas son de un color gris cálido. Los tableros de las mesas de centro y mesas auxiliares están formados por una placa autoportante de compuesto mineral que ha sido cortada mediante chorro de agua a partir de placas de excelente porcelana sinterizada, las más grandes del mercado. Limpiar la estructura y el tablero con un paño suave y agua tibia.

**IT** BREIA è una collezione lounging confortevole e intelligente, caratterizzata da elementi imbottiti appositamente concepiti per l'utilizzo in ambienti esterni e interni. I cuscini BREIA sono facilmente infilabili sulla struttura metallica e altrettanto facilmente rimovibili. Disponibili in tessuti Cat A, Cat B (incl. KVADRAT) e Cat C. I cuscini sono sfoderabili. In esclusiva per BREIA, i cuscini e i cuscini decorativi sono disponibili in sail cloth light gray. I cuscini sono protetti da una fodera in poliestere idrorepellente. Il tessuto viene trattato in modo da risultare resistente alla polvere e idrorepellente. Se non vengono utilizzati sotto tettoie o ripari, si consiglia di coprire i moduli con i teli da esterno DEDON durante la notte e in caso di pioggia.

BREIA si compone di un telaio in metallo verniciato a polvere, gambe e connettori universali in alluminio pressofuso e fasce elastiche per esterno in tessuto Sunbrella® per un maggior confort. Tutte le fasce sono caratterizzate da una tonalità di grigio caldo. Il piano dei tavolini da salotto e dei tavolini d'appoggio è costituito da una lastra autoportante in minerale composito, tagliata a getto d'acqua e ricavata dalle più ampie lastre in porcellana sinterizzata di alta qualità disponibili sul mercato. Per la pulizia del telaio e il piano dei tavolini, utilizzare un panno morbido e acqua tiepida.

**FR** BREIA est une collection confortable et bien pensée de lounge qui propose des revêtements et des éléments de rembourrage élaborés avec minutie pour une utilisation à l'intérieur comme à l'extérieur. Les coussins BREIA paraissent certes fixes, mais ils peuvent être retirés en toute simplicité du cadre en métal. Ils sont disponibles dans des tissus des catégories A, B (incl. KVADRAT) et C. Exclusivité BREIA : les coussins et les coussins de décoration sont disponibles avec le tissu sail cloth light gray fabric. Les housses des coussins peuvent également être retirées. Le cœur de chaque module est protégé par une housse en polyester hydrofuge. Le tissu est traité pour être anti-tache et hydrofuge. Si les modules ne sont pas protégés par un toit ou un auvent, nous vous recommandons de les couvrir avec des housses d'extérieur DEDON pendant la nuit ou pendant les périodes de pluie.

BREIA est composé de pieds et de raccords en aluminium moulé universel ainsi que d'un cadre en métal thermo-laqué. Des sangles outdoor élastiques de la marque Sunbrella® garantissent davantage de confort. Les sangles sont disponibles dans un gris chaleureux (warm gray). Les plateaux des tables de salon et des tables d'appoint sont fabriqués dans un matériau minéral composite autoportant, lequel est découpé par jet hydraulique à partir des meilleures plaques de porcelaine frittées disponibles sur le marché. Nettoyez le cadre et le plateau de table avec chiffon doux et de l'eau chaude.



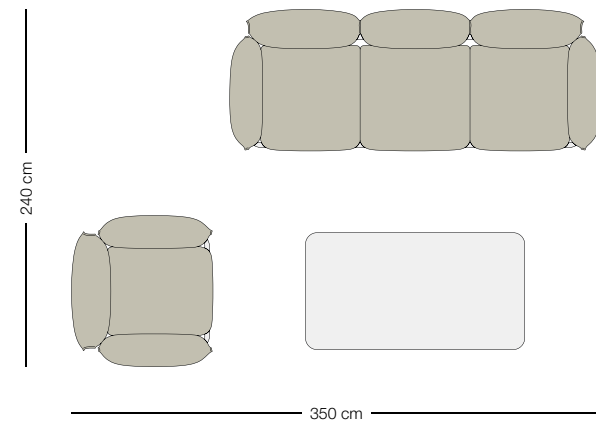

**BREA Setting 1**

- 1x 107021 – 3-Seater, set of cushions
- 1x 107001 – Lounge chair, set of cushions
- 1x 107035 – Coffee table 80 x 150 cm

- Recommended deco cushions:
- 4x 95050090 – 25 x 62 cm
  - 1x 95050082 – 50 x 50 cm
  - 1x 95050081 – 40 x 40 cm

For inspiration please see pages 11, 12–13

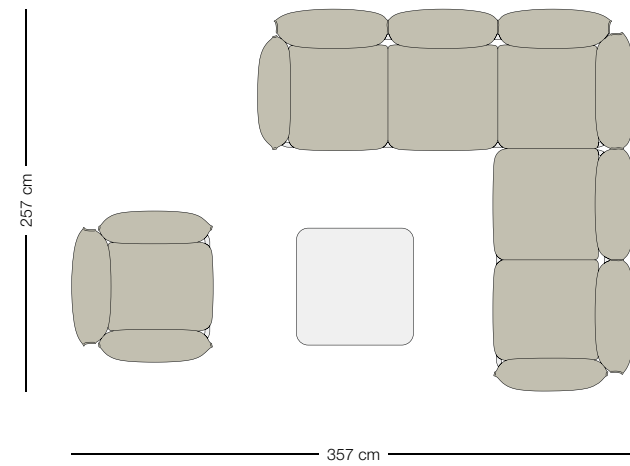

**BREA Setting 2**

- 1x 107062 – Corner sofa, set of cushions
- 1x 107001 – Lounge chair, set of cushions
- 1x 107033 – Coffee table 90 x 90 cm

- Recommended deco cushions:
- 7x 95050090 – 25 x 62 cm
  - 2x 95050082 – 50 x 50 cm
  - 2x 95050081 – 40 x 40 cm

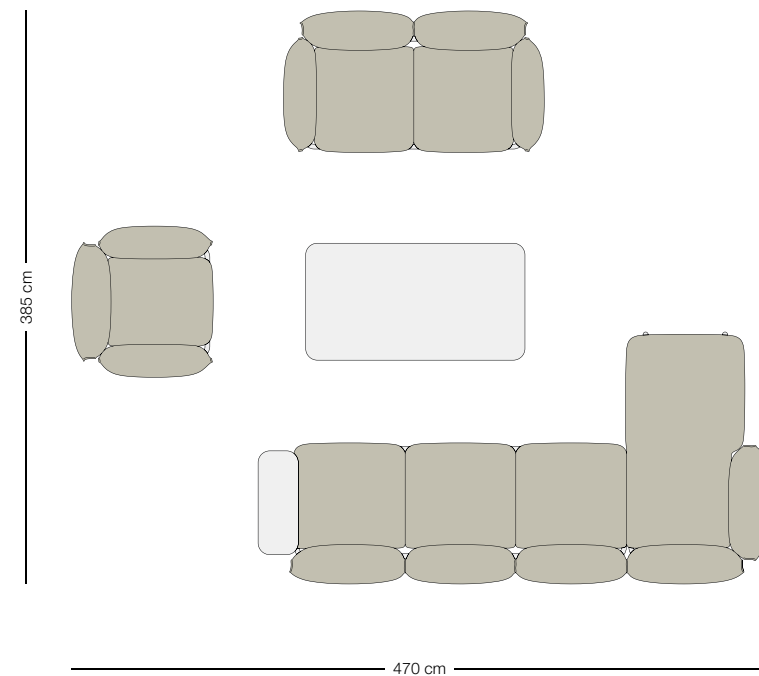

**BREA Setting 3**

- 1x 107011 – 2-Seater, set of cushions
- 1x 107001 – Lounge chair, set of cushions
- 1x 107035 – Coffee table 80 x 150 cm
- 1x 107057 – 4-Seater daybed right, set of cushions

- Recommended deco cushions:
- 7x 95050090 – 25 x 62 cm
  - 3x 95050082 – 50 x 50 cm
  - 3x 95050081 – 40 x 40 cm



BREA lounge chair, white  
Cushion: PUNO reed





Sofa module M, PUNO straw  
Side table triangular, lipari  
Sofa module L, PUNO reed  
Module S, PUNO straw/reed  
Sofa module M, PUNO straw  
Side table triangular, lipari

Recommended fabrics for backrest round, backrest triangular, square cushion

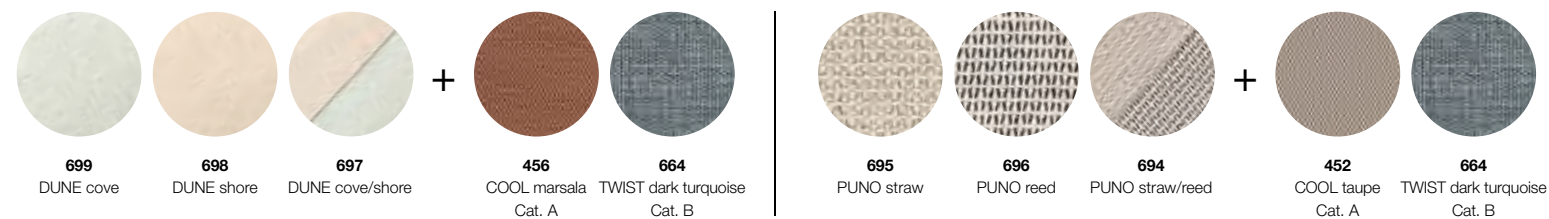

MODULE S  
Modul S  
Módulo S  
Modulo S  
Module S  
**95 x 95 cm**  
28 kg 0,4 m<sup>3</sup>



092016699



092016698



092016697

092016



56092016000



092016695



092016696



092016694

SOFA MODULE CORNER LEFT  
Sofa Eckmodul links  
Módulo sofá esquina izquierdo  
Divano modulo angolare sinistro  
Canapé module d'angle gauche  
**98 x 98 cm**  
48,3 kg 0,69 m<sup>3</sup>



092019699

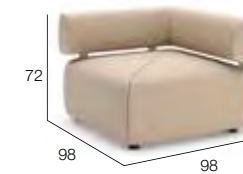

092019698



56092018000



092019695



092019696

SOFA MODULE CORNER RIGHT  
Sofa Eckmodul rechts  
Módulo sofá esquina derecho  
Divano modulo angolare destro  
Canapé module d'angle droit  
**98 x 98 cm**  
48,3 kg 0,69 m<sup>3</sup>



092018699



092018698



56092018000



092018695



092018696

**EN** BRIXX is only available in DUNE and PUNO fabric. Circle cushion is only available in DUNE cove/shore 697 and PUNO straw/reed 694. Sphere cushion is only available in COOL marsala 456.

**DE** BRIXX ist nur erhältlich in den Stoffen DUNE und PUNO. Das runde Kissen ist nur in DUNE cove/shore 697 und PUNO straw/reed 694 verfügbar. Das kugelförmige Kissen ist nur in COOL marsala 456 erhältlich.

**ES** BRIXX sólo se encuentra disponible en tejidos DUNE y PUNO. El cojín redondo sólo se encuentra disponible en cove/shore DUNE 697 y straw/reed PUNO 694. El cojín circular sólo se encuentra disponible en marsala COOL 456.

**IT** BRIXX è disponibile solo con i tessuti DUNE e PUNO. Il cuscino rotondo è disponibile soltanto con DUNE cove/shore 697 e PUNO straw/reed 694. Il cuscino sferico è disponibile in COOL marsala 456.

**FR** BRIXX est uniquement disponible avec les tissus DUNE et PUNO. Le coussin rond est uniquement disponible dans les variantes DUNE cove/shore 697 et PUNO straw/reed 694. Le coussin boule est uniquement disponible dans la variante COOL marsala 456.



SOFA MODULE S  
Sofa Modul S  
Módulo sofá S  
Divano modulo S  
Canapé Module S  
**98 x 95 cm**  
39,8 kg 0,67 m<sup>3</sup>



092017699



092017698



092017695



092017696



56092017000

MODULE M  
Modul M  
Módulo M  
Modulo M  
Module M  
**95 x 160 cm**  
46,6 kg 0,7 m<sup>3</sup>



092013699



092013698



092013697



092013695



092013696



092013694



56092013000

SOFA MODULE M  
Sofa Modul M  
Módulo sofá M  
Divano modulo M  
Canapé Module M  
**98 x 160 cm**  
60,3 kg 1,1 m<sup>3</sup>



092012699



092012698



092012695



092012696



56092012000

BACKREST TRIANGULAR  
Rückenlehne dreieckig  
Respaldo triangular  
Poggiaschiena triangolare  
Dossier triangulaire  
7,3 kg 0,05 m<sup>3</sup>

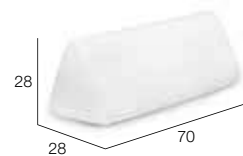

95092010

BACKREST ROUND  
Rückenlehne rund  
Respaldo redondo  
Poggiaschiena a cilindro  
Dossier rond  
7,3 kg 0,05 m<sup>3</sup>

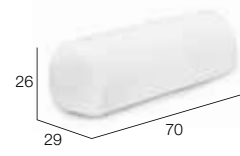

95092012

MODULE L  
Modul L  
Módulo L  
Modulo L  
Module L  
**95 x 190 cm**  
53,5 kg 0,78 m<sup>3</sup>



092014699



092014698



092014697



092014695



092014696



092014694



56092014000

SOFA MODULE L  
Sofa Modul L  
Módulo sofá L  
Divano modulo L  
Canapé Module L  
**98 x 190 cm**  
70,7 kg 1,3 m<sup>3</sup>



092015699



092015698



092015695



092015696



56092015000

SIDE TABLE TRIANGULAR  
Beistelltisch dreieckig  
Mesa triangular  
Tavolino triangolare  
Table d'appoint triangulaire  
17 kg 0,35 m<sup>3</sup>

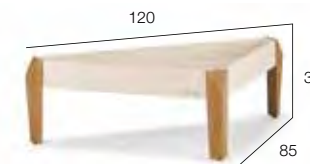

092035098



56092035000

CIRCLE CUSHION  
Kissen rund  
Cojín redondo  
Cuscino rotondo  
Coussin rond



95092089697



95092089694

ø 55

SQUARE CUSHION  
Kissen viereckig  
Cojín cuadrado  
Cuscino quadrato  
Coussin carré

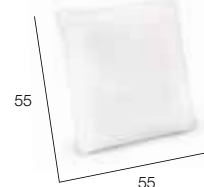

95092084

SPHERE CUSHION  
Kissen kugelförmig  
Cojín circular  
Cuscino sferico  
Coussin boule



ø 18 cm

95092085456



**EN** BRIXX is a comfortable, upholstered modular system for indoor and outdoor use. Its **structure** consists of a powder-coated steel frame encased in molded polyurethane foam, with belting for extra comfort.

The **core** of each module is protected by a water-repellent polyester covering. The fabric is treated to be stain- and water-repellent. If not used under roof or awning, we recommend covering the modules with DEDON outdoor covers at night and during rainfall.

The **fabric** consists of 50% acrylic yarn and 50% recycled post-industrial acrylic yarn. Like all DEDON acrylic fabrics, those used for BRIXX are highly UV-resistant. The recycled yarn includes imperfections that give the fabric its very natural and appealing look.

The triangular and round **backrests** are equipped with a heavy core and anti-slip pads in order to give ideal support. The side table consists of a powder-coated aluminum top and natural teak legs.

**DE** BRIXX ist ein komfortables, gepolstertes Modulare System, das Sie sowohl im Innen- als auch im Außenbereich nutzen können. Die Möbel dieser Kollektion bestehen aus pulverbeschichteten **Stahlrahmen**, die mit formgeschäumtem Polyurethan-Schaum verkleidet sind. Riemen sorgen für noch mehr Komfort. Der **Kern** jedes Moduls wird von einer wasserabweisenden Polylesterschicht geschützt. Der Stoff ist so behandelt, dass er schmutz- und wasserabweisend ist. Wenn Sie die Möbel nicht auf einer überdachten Fläche oder unter einer Markise aufstellen, empfehlen wir, die Module nachts und bei Regen mit DEDON Hussen zu schützen.

Der **Stoff** besteht zu 50% aus Acrylgarn und zu 50% aus recyceltem Acrylgarn. Wie alle DEDON Stoffe aus Acryl sind auch die Stoffe, die für BRIXX verwendet werden, extrem widerstandsfähig gegen UV-Strahlen. Das recycelte Garn zeichnet sich durch kleine Unregelmäßigkeiten aus, was dem Stoff einen sehr natürlichen und außergewöhnlichen Look verleiht. Die dreieckigen und runden **Rückenlehnen** sind mit einem schweren Kern und rutschfestem Unterboden ausgestattet, wodurch sie ideal stützen. Der Beistelltisch wird aus pulverbeschichtetem Aluminium und Beinen aus naturbelassenem Teakholz gefertigt.

**ES** BRIXX es un cómodo sistema tapizado y modular de uso tanto en interiores como en exteriores. Su **estructura** consiste en un armazón de acero electro pintado recubierto con espuma moldeada de poliuretano, con cinturones para mayor comodidad. El **núcleo** de cada módulo está protegido con un revestimiento impermeable de poliéster. La tela está tratada para ser resistente a las manchas y al agua. Si no se utiliza bajo techo o toldo, se recomienda cubrir los módulos con las fundas para exteriores DEDON por la noche y durante las lluvias.

El **tejido** se compone de fibras con un 50 % de acrílico y un 50 % de acrílico reciclado. Al igual que todos los tejidos acrílicos DEDON, los tejidos utilizados por BRIXX son también altamente resistentes a los rayos UV. La fibra reciclada incluye imperfecciones que dotan a la tela de un aspecto muy natural y atractivo. Los **respaldos** triangulares y redondos están equipados con un pesado núcleo y textil antideslizante con el fin de proporcionar un soporte ideal. La mesa triangular consiste de un sobre de aluminio con acabado de pintura en polvo y patas de teca natural.

**IT** BRIXX è un sistema modulare imbottito e confortevole che si può usare sia all'interno che per all'esterno. La sua **struttura** si compone di un telaio in acciaio verniciato a polvere inserito in una schiuma poliuretanic sagomata, con cinghie che assicurano il massimo comfort. L'**anima** di ogni modulo è rivestita una custodia in poliestere idrorepellente. Il tessuto viene trattato in modo da risultare resistente alla polvere e idrorepellente. Se non vengono utilizzati sotto tettoie o ripari, si consiglia di coprire i moduli con i teli da esterno DEDON durante la notte e in caso di pioggia.

Il **tessuto** si compone al 50% di filato acrilico e al 50% di filato acrilico riciclato. Come tutti i tessuti acrilici di DEDON, anche i tessuti utilizzati per BRIXX sono estremamente resistenti ai raggi UV. Il filato acrilico presenta delle imperfezioni che gli conferiscono il suo aspetto naturale e piacevole.

I **poggiaschiena** a cilindro e triangolare sono dotati di un'anima pesante e di tappetini antiscivolo che permettono il sostegno ideale della schiena. Il tavolino d'appoggio si compone di un piano in alluminio verniciato a polvere e di gambe in teak naturale.

**FR** BRIXX est un système modulaire, confortable et capitonné, qui convient à une utilisation à l'intérieur comme à l'extérieur. Sa **structure** se compose d'un cadre en acier laqué encastré dans une mousse en polyuréthane moulé. Le tout est entouré d'une sangle pour un confort optimal.

Le **coeur** de chaque module est protégé par une housse en polyester hydrofuge. Le tissu est traité pour être anti-tache et hydrofuge. Si les modules ne sont pas protégés par un toit ou un auvent, nous vous recommandons de les couvrir avec des housses d'extérieur DEDON pendant la nuit ou pendant les périodes de pluie. Les **tissus** sont composés de 50% de fils acryliques et de 50% de fils acryliques recyclés. Comme tous les tissus acryliques DEDON, les tissus qui équipent la collection Brix sont hautement résistants aux rayons UV. Les fils recyclés comportent des imperfections qui donnent au tissu un aspect très naturel et très attrayant.

Les **dossiers** triangulaires et ronds sont équipés d'une garniture épaisse et de coussinets antidérapants pour vous donner un soutien optimal. La table d'appoint est composée d'une plaque en aluminium laqué et de pieds en teck naturel.

# BRIXX

## OPTIONAL COMBINATIONS

### BRIXX Setting S

- 1x 092012 – Sofa module M + Sphere cushion + Square cushion
- 1x 092019 – Sofa corner module + Circle cushion
- 1x 092012 – Sofa module M + Square cushions

For inspiration please see page 71

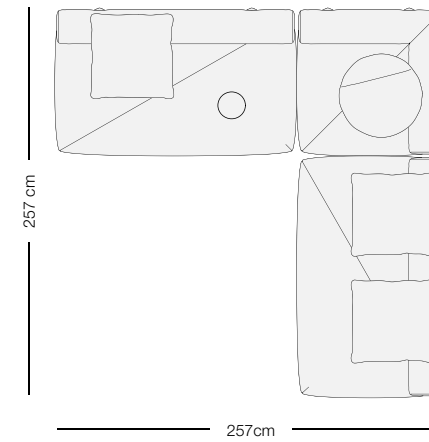

### BRIXX Setting M

- 1x 092017 – Sofa module S + Circle cushion
- 2x 092035 – Side table triangular
- 1x 092015 – Sofa module L + Square cushions
- 1x 092016 – Module S
- 1x 092012 – Sofa module M + Sphere cushion + Square cushion

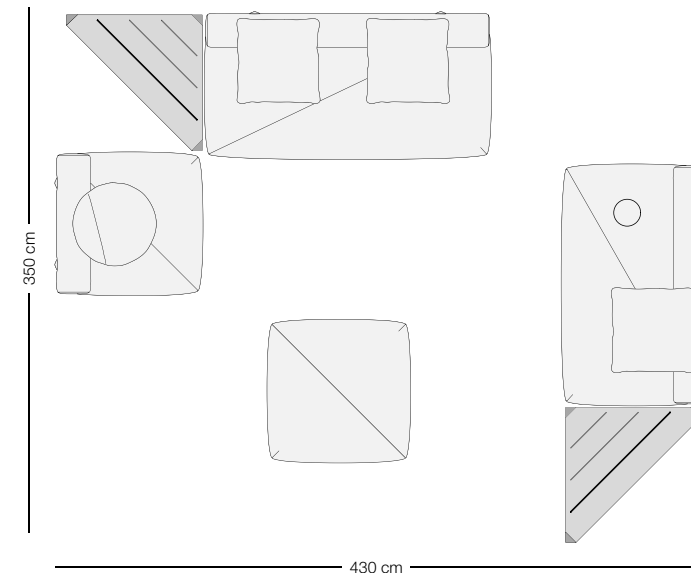

### BRIXX Setting L

- 1x 092016 – Module S, Backrest round
- 3x 092035 – Side table triangular
- 2x 092013 – Module M, Backrest triangular + Square cushion
- 1x 092016 – Module S
- 1x 092014 – Module L
- 1x 092016 – Module S, Backrest round + Circle cushion
- 1x 092016 – Module S, Circle cushion

For inspiration please see pages 72-73

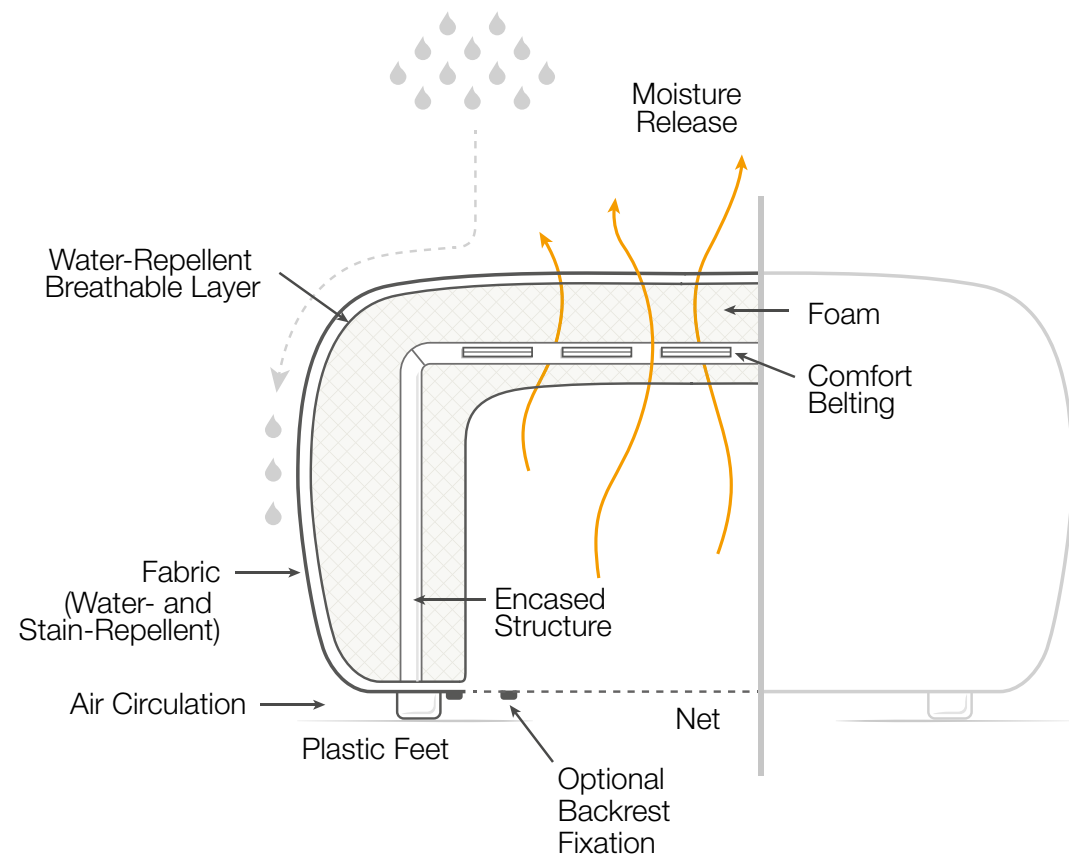
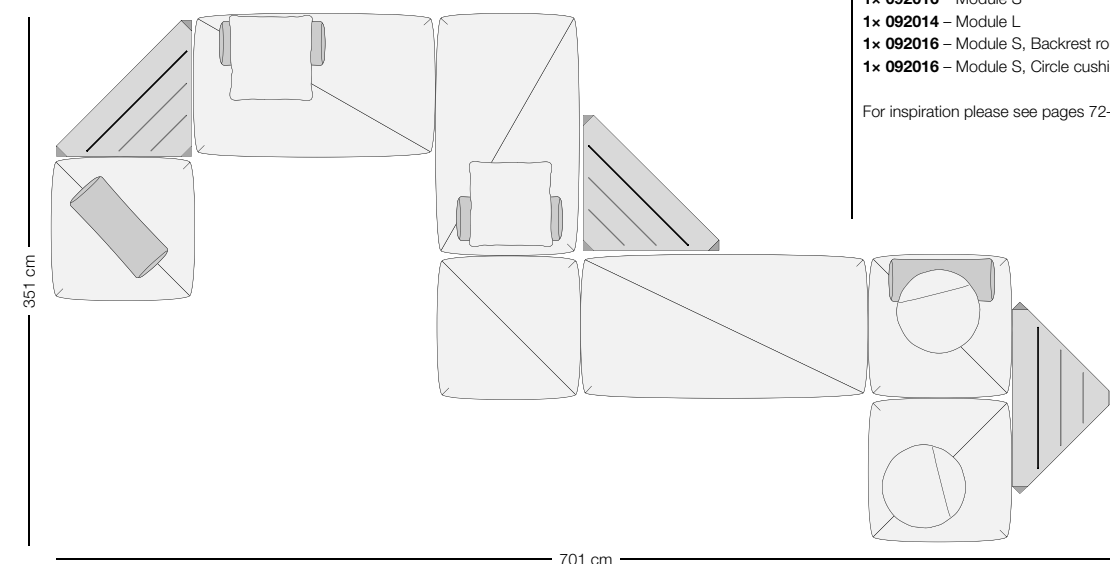





Lounge chair  
Coffee table ø 89 cm  
Stool ø 46 cm

Combinations



LOUNGE CHAIR  
Sessel  
Sillón bajo  
Poltrona club  
Fauteuil club  
9,3 kg 0,72 m³



Set: 073006532 \*

SEAT CUSHION  
Sitzkissen  
Cojín de asiento  
Cuscino seduta  
Coussin d'assise  
ø 88 cm

BACK CUSHION  
Rückenkissen  
Cojín de respaldo  
Cuscino schienale  
Coussin de dossier  
50 x 40 cm



073005

95073037735

95073005735

56073005000

LOUNGE CHAIR  
Sessel  
Sillón bajo  
Poltrona club  
Fauteuil club  
9,3 kg 0,72 m³



Set: 073006533 \*

SEAT CUSHION  
Sitzkissen  
Cojín de asiento  
Cuscino seduta  
Coussin d'assise  
ø 88 cm

BACK CUSHION  
Rückenkissen  
Cojín de respaldo  
Cuscino schienale  
Coussin de dossier  
50 x 40 cm



073005

95073037761

95073005761

56073005000

LOUNGE CHAIR  
Sessel  
Sillón bajo  
Poltrona club  
Fauteuil club  
9,3 kg 0,72 m³



Set: 073006534 \*

SEAT CUSHION  
Sitzkissen  
Cojín de asiento  
Cuscino seduta  
Coussin d'assise  
ø 88 cm

BACK CUSHION  
Rückenkissen  
Cojín de respaldo  
Cuscino schienale  
Coussin de dossier  
50 x 40 cm



073005

95073037762

95073005762

56073005000

RECOMMENDED DECO CUSHIONS, FIRE  
Empfohlene Dekokissen, fire  
Cojines decoración recomendados, fire  
Cuscini decorativi consigliati, fire  
Coussins déco, fire, recommandés  
ø 40 cm LINEN sand, 50 x 50 cm CURL taupe



RECOMMENDED DECO CUSHIONS, GRASS  
Empfohlene Dekokissen, grass  
Cojines decoración recomendados, grass  
Cuscini decorativi consigliati, grass  
Coussins déco, grass, recommandés  
ø 40 cm LINEN sand, 50 x 50 cm COOL taupe



RECOMMENDED DECO CUSHIONS, STONE  
Empfohlene Dekokissen, stone  
Cojines decoración recomendados, stone  
Cuscini decorativi consigliati, stone  
Coussins déco, stone, recommandés  
ø 40 cm LINEN sand, 50 x 50 cm LINEN warm gray

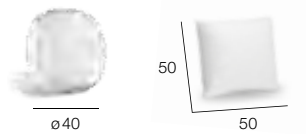
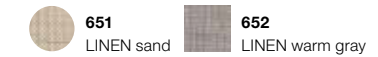

95050088651, 95050082613

95050088651, 95050082452

95050088651, 95050082652

LOVESEAT  
Sofaindel  
Sofá isla  
Isola 2 posti  
L'îlot câlin  
ø 179 cm  
30 kg 2,51 m³



073004532

SEAT CUSHION  
Sitzkissen  
Cojín de asiento  
Cuscino seduta  
Coussin d'assise  
ø 165 cm



073004

95073014735

56073004000

LOVESEAT  
Sofaindel  
Sofá isla  
Isola 2 posti  
L'îlot câlin  
ø 179 cm  
30 kg 2,51 m³



073004533

SEAT CUSHION  
Sitzkissen  
Cojín de asiento  
Cuscino seduta  
Coussin d'assise  
ø 165 cm



073004

95073014761

56073004000

LOVESEAT  
Sofaindel  
Sofá isla  
Isola 2 posti  
L'îlot câlin  
ø 179 cm  
30 kg 2,51 m³



073004534

SEAT CUSHION  
Sitzkissen  
Cojín de asiento  
Cuscino seduta  
Coussin d'assise  
ø 165 cm



073004

95073014762

56073004000

\* EN Set includes lounge chair, seat cushion and back cushion. DE Das Set beinhaltet den Sessel, das Sitz- sowie das Rückenkissen. ES „Set“ incluye un sillón bajo, con su cojín de asiento y de respaldo. IT Il set include una poltrona, un cuscino seduta e un cuscino schienale. FR Le set comprend le fauteuil club, le coussin d'assise et le coussin de dossier.



RECOMMENDED DECO CUSHIONS

Empfohlene Dekokissen  
Cojines decoración recomendados  
Cuscini decorativi consigliati  
Cousins déco recommandés  
**1x 70 x 70 cm** TABRIZ taupe/gray, **1x 70 x 70 cm** LINEN warm gray,  
**1x 60 x 60 cm** TABRIZ taupe/gray, **1x 50 x 50 cm** LINEN warm gray,  
**1x 50 x 50 cm** LINEN off white, **1x 40 x 40 cm** COOL white

- 567**  
TABRIZ taupe/gray
- 652**  
LINEN warm gray
- 650**  
LINEN off white
- 450**  
COOL white

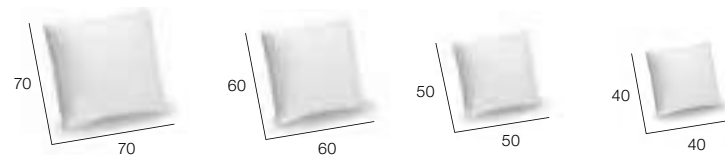

**1x 95050086567, 1x 95050086652, 1x 95050084567,**  
**1x 95050082652, 1x 95050082650, 1x 95050081450**

**EN** The Loveseat is shipped with pre-mounted pullout casters. **DE** Die Sofainsel wird inkl. vormontierter ausklappbarer Räder geliefert. **ES** El sofá isla se entrega con ruedas premontadas plegables. **IT** L'isola viene fornita completa di ruote pieghevoli. **FR** L'îlot câlin est fourni avec des roues prémontées escamotables.



STOOL / SIDE TABLE

Hocker / Beistelltisch  
Asiento / Mesa auxiliar  
Pouf / Tavolino d'appoggio  
Tabouret / Table d'appoint  
**ø 46 cm**  
4,5 kg 0,16 m³



**073035**

073035**532**

SEAT CUSHION

Sitzkissen  
Cojin de asiento  
Cuscino seduta  
Coussin d'assise  
ø 43 cm



Set: 073036**532**

GLASS FIRE

Glas fire  
Sobre de cristal fire  
Piano in vetro fire  
Plaque en verre fire  
2,3 kg



**22273033313**

**56073035000**

STOOL / SIDE TABLE

Hocker / Beistelltisch  
Asiento / Mesa auxiliar  
Pouf / Tavolino d'appoggio  
Tabouret / Table d'appoint  
**ø 46 cm**  
4,5 kg 0,16 m³

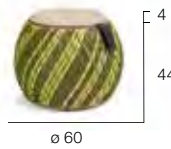

**073035**

073035**533**

SEAT CUSHION

Sitzkissen  
Cojin de asiento  
Cuscino seduta  
Coussin d'assise  
ø 43 cm



Set: 073036**533**

GLASS GRASS

Glas grass  
Sobre de cristal grass  
Piano in vetro grass  
Plaque en verre grass  
2,3 kg



**22273033312**

**56073035000**

STOOL / SIDE TABLE

Hocker / Beistelltisch  
Asiento / Mesa auxiliar  
Pouf / Tavolino d'appoggio  
Tabouret / Table d'appoint  
**ø 46 cm**  
4,5 kg 0,16 m³



**073035**

073035**534**

SEAT CUSHION

Sitzkissen  
Cojin de asiento  
Cuscino seduta  
Coussin d'assise  
ø 43 cm



Set: 073036**534**

GLASS STONE

Glas stone  
Sobre de cristal stone  
Piano in vetro stone  
Plaque en verre stone  
2,3 kg



**22273033314**

**56073035000**

FOOTSTOOL / COFFEE TABLE

Hocker / Kaffeetisch  
Taburete / Mesa de centro  
Pouf / Tavolino da salotto  
Repose-pieds / Table de salon  
**ø 89 cm**  
6,7 kg 0,29 m³



**073037**

073037**532**

SEAT CUSHION

Sitzkissen  
Cojin de asiento  
Cuscino seduta  
Coussin d'assise  
ø 88 cm



Set: 073038**532**

GLASS FIRE

Glas fire  
Sobre de cristal fire  
Piano in vetro fire  
Plaque en verre fire  
10,3 kg



**22273037313**

**56073037000**

FOOTSTOOL / COFFEE TABLE

Hocker / Kaffeetisch  
Taburete / Mesa de centro  
Pouf / Tavolino da salotto  
Repose-pieds / Table de salon  
**ø 89 cm**  
6,7 kg 0,29 m³



**073037**

073037**533**

SEAT CUSHION

Sitzkissen  
Cojin de asiento  
Cuscino seduta  
Coussin d'assise  
ø 88 cm



Set: 073038**533**

GLASS GRASS

Glas grass  
Sobre de cristal grass  
Piano in vetro grass  
Plaque en verre grass  
10,3 kg



**22273037312**

**56073037000**

FOOTSTOOL / COFFEE TABLE

Hocker / Kaffeetisch  
Taburete / Mesa de centro  
Pouf / Tavolino da salotto  
Repose-pieds / Table de salon  
**ø 89 cm**  
6,7 kg 0,29 m³



**073037**

073037**534**

SEAT CUSHION

Sitzkissen  
Cojin de asiento  
Cuscino seduta  
Coussin d'assise  
ø 88 cm



**95073037762**

Set: 073038**534**

GLASS STONE

Glas stone  
Sobre de cristal stone  
Piano in vetro stone  
Plaque en verre stone  
10,3 kg



**22273037314**

**56073037000**

Tabletops Glass



**313** fire  
Top: satinated stripes  
Bottom: lacquered in fire



**312** grass  
Top: satinated stripes  
Bottom: lacquered in grass



**314** stone  
Top: satinated stripes  
Bottom: lacquered in stone

**EN** The **swiveling table** of the DALA loveseat consists of a powder-coated aluminum post and a tabletop of cross-laminated premium teak veneer.

The **DALA cushions** are covered with sophisticated Batyline® fabric, produced with a special quilting technique that reflects the design of the furniture itself. For the best-matching deco-cushions, we recommend our selection of acrylic fabrics (see 'recommended deco-cushions'). As an alternative, cushions made out of our standard fabrics are available upon request.

**DE** Der **Schwenktisch** der DALA Sofainsel besteht aus einer pulverbeschichteten Aluminiumhalterung und einer Tischplatte aus hochwertigem Teak-Schichtholz.

Die **DALA Kissenhüllen** sind aus Batyline®-Stoff gefertigt, einem Material, das höchsten Ansprüchen gerecht wird. Die Kissen werden in einer speziellen Quilt-Technik vernäht, die das Design des Möbels widerspiegelt. Als Dekokissen empfehlen wir unsere Acryl-Stoffe (siehe „empfohlene Dekokissen“). Kissen in unseren Standardstoffen sind auf Anfrage erhältlich.

**ES** La **mesa giratoria** integrada en el DALA sofá isla está hecha de aluminio revestido con pintura poliéster en polvo altamente resistente y un tablero de chapa de madera de teca laminada de la mejor calidad.

**Los cojines DALA** están cubiertos con el sofisticado tejido Batyline®, confeccionados con una técnica especial de confección de acolchado que refleja el diseño del mismo mobiliario. Para conseguir los mejores cojines decorativos a juego, recomendamos nuestra selección de tejidos de acrílico (véanse los "cojines decorativos recomendados"). Como alternativa, los cojines hechos con nuestros tejidos estándar están disponibles bajo pedido.

**IT** Il **tavolino girevole** dell' isola 2 posti DALA è composto da una base in alluminio verniciato a polvere e da un piano con impiallacciatura in teak di ottima qualità.

I **cuscini DALA** sono rivestiti con il raffinato tessuto Batyline®, prodotto con una speciale tecnica di trapuntatura che si richiama al design del mobile stesso. Per abbinare al meglio i cuscini decorativi consigliamo la nostra selezione di tessuti acrilici (si veda la sezione "cuscini decorativi"). In alternativa, i cuscini decorativi realizzati con i nostri tessuti standard sono disponibili su richiesta. Il vaso interno estraibile è fabbricato in polietilene rotostampato.

**FR** La **tablette pivotante** de l'îlot câlin DALA est constituée d'une structure en aluminium thermolaqué et d'un plateau en teck contreplaqué de qualité supérieure.

Les **coussins DALA** sont recouverts de tissu Batyline®, confectionnés avec une technique spéciale de matelassage qui fait écho au design du meuble. Notre sélection de textiles acryliques vous aidera à trouver les meilleurs coussins assortis au mobilier (voir « coussins déco conseillés »). La confection de coussins dans l'une de nos matières standard, est proposée sur commande uniquement.





DEAN Armchair  
SEAX Dining table 100 x 220 cm

Material

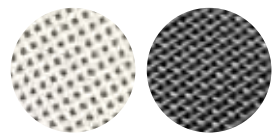

704 pearl gray & white  
705 anthracite & black

ARMCHAIR  
Armlehnstuhl  
Silla con brazos  
Poltrona pranzo  
Fauteuil repas  
11 kg 0,29 m<sup>3</sup>



801001704



802001705



56800001000

LOUNGE CHAIR  
Sessel  
Sillón bajo  
Poltrona club  
Fauteuil club  
11 kg 0,3 m<sup>3</sup>



801005704



802005705



56800005000

Complementary Tables



SEAX Dining table teak/white  
100 x 220 cm  
See page 237



SEAX Coffee table ebony/black  
ø 110 cm  
See page 239



SATELLITE Side table white  
ø 40 cm  
See page 229

OPTIONAL COMBINATIONS

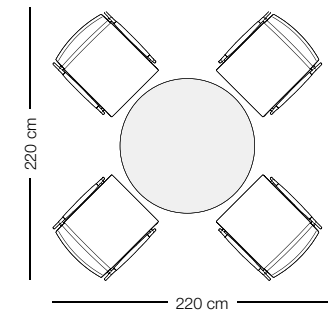

DEAN MEETS SEAX  
LOUNGE SETTING

1x 702036 – SEAX Coffee table Ø 110 cm, ebony/black  
4x 801005 – DEAN Lounge chair

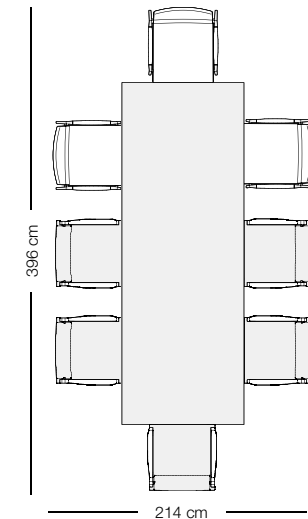

DEAN MEETS SEAX  
DINING SETTING

1x 702040 – SEAX Dining table 100 x 220 cm, teak  
5x 702311 – SEAX Armchair  
3x 802001 – DEAN Armchair

**EN** DEAN's frame is made of powder-coated aluminum. Its seat and back consist of textile in a mix of PVC and PES. Clean frame, seat and backrest with a soft cloth and warm water. Clean natural-teak armrest inlays with a damp cloth, and do not apply cleaning detergents of any kind.

**DE** Der Rahmen von DEAN besteht aus pulverbeschichtetem Aluminium. Das Gewebe der Sitzfläche und der Rückenlehne ist eine Mischung aus PVC und Polyester. Reinigen Sie den Rahmen, die Sitzfläche und die Rückenlehne mit einem weichen Tuch und warmem Wasser. Die Einlage in den Armlehnen besteht aus naturbelasstem Teakholz. Diese reinigen Sie mit einem feuchten Tuch und keinesfalls mit Reinigungsmitteln.

**ES** El armazón de DEAN está hecho de aluminio de fundición revestido de pintura en polvo. Su asiento y respaldo constan de un tejido mezcla de PVC y PES. Limpie la estructura, asiento y respaldo con un paño suave y agua tibia. Limpie las incrustaciones en los reposabrazos de teca natural con un paño húmedo y no aplique detergentes limpiadores de ningún tipo.

**IT** Il telaio di DEAN è realizzato in alluminio verniciato a polvere. La seduta e lo schienale sono in un tessuto sintetico composto da PVC e PES. Pulire il telaio, la seduta e lo schienale con un panno morbido e acqua calda. Pulire gli inserti in teak naturale sui braccioli con un panno umido, senza applicare detergenti di alcun tipo.

**FR** Le cadre de DEAN est fabriqué en aluminium laqué. Le siège et le dossier ont été créés dans un mélange de PVC et de polyester. Nettoyez le cadre, le siège et le dossier avec un chiffon doux et de l'eau chaude. Nettoyez les insertions des accoudoirs en teck naturel avec un chiffon humide. N'utilisez jamais de détergents.





Right module  
Center module  
Corner module  
Coffee table 68 x 126 cm  
Tray  
Cushion: COOL taupe 452

Recommended combination

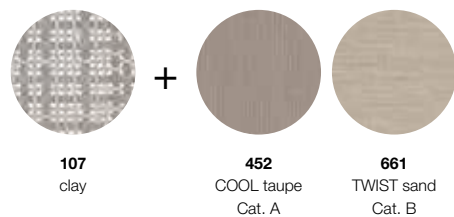

LOUNGE CHAIR  
Sessel  
Sillón bajo  
Poltrona club  
Fauteuil club  
16 kg 0,71 m³



SEAT CUSHION + BACK CUSHION  
Sitzkissen + Rückenkissen  
Cojín de asiento + Cojín de respaldo  
Cuscino seduta + Cuscino schienale  
Coussin d'assise + Coussin de dossier  
68 x 68 cm + 102 x 38 cm

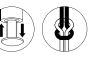

079005

079005107

95079005

56079005000

CENTER MODULE  
Modul mitte  
Módulo centro  
Modulo centrale  
Module central  
13 kg 0,71 m³



SEAT CUSHION + BACK CUSHION  
Sitzkissen + Rückenkissen  
Cojín de asiento + Cojín de respaldo  
Cuscino seduta + Cuscino schienale  
Coussin d'assise + Coussin de dossier  
102 x 68 cm + 102 x 38 cm

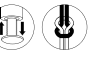

079008

079008107

95079008

56079008000

LEFT MODULE  
Modul links  
Módulo izquierdo  
Modulo sinistro  
Module gauche  
16 kg 0,95 m³



SEAT CUSHION + BACK CUSHION + SIDE CUSHION  
Sitzkissen + Rückenkissen + Seitenkissen  
Cojín de asiento + Cojín de respaldo + Cojín lateral  
Cuscino seduta + Cuscino schienale + Cuscino laterale  
Coussin d'assise + Coussin de dossier + Coussin latéral  
102 x 68 cm + 136 x 38 cm + 39 x 31 x 6 cm

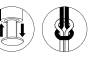

079007

079007107

95079007

56079007000

RIGHT MODULE  
Modul rechts  
Módulo derecho  
Modulo destro  
Module droit  
16 kg 0,95 m³



SEAT CUSHION + BACK CUSHION + SIDE CUSHION  
Sitzkissen + Rückenkissen + Seitenkissen  
Cojín de asiento + Cojín de respaldo + Cojín lateral  
Cuscino seduta + Cuscino schienale + Cuscino laterale  
Coussin d'assise + Coussin de dossier + Coussin latéral  
102 x 68 cm + 136 x 38 cm + 39 x 31 x 6 cm

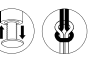

079006

079006107

95079007

56079006000

CORNER MODULE  
Eckmodul  
Módulo esquina  
Modulo d'angolo  
Module d'angle  
14 kg 0,71 m³



SEAT CUSHION + CORNER BACK CUSHION  
Sitzkissen + Rückenkissen über Eck  
Cojín de asiento + Cojín de respaldo de esquina  
Cuscino seduta + Cuscino schienale angolare  
Coussin d'assise + Coussin de dossier formant un angle  
68 x 68 cm + 150 x 38 cm

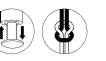

079009

079009107

95079009

56079009000

CURVED MODULE  
Bogenmodul  
Módulo curvo  
Modulo curvo  
Module incurvé  
19 kg 1,4 m³



SEAT CUSHION + BACK CUSHION  
Sitzkissen + Rückenkissen  
Cojín de asiento + Cojín de respaldo  
Cuscino seduta + Cuscino schienale  
Coussin d'assise + Coussin de dossier  
162 x 68 cm + 168 x 38 cm

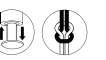

079010

079010107

95079010

56079010000

CHAISE LONGUE  
Chaise longue  
Chaise longue  
Chaise longue  
20 kg 1,2 m³



SEAT CUSHION + BACK CUSHION  
Sitzkissen + Rückenkissen  
Cojín de asiento + Cojín de respaldo  
Cuscino seduta + Cuscino schienale  
Coussin d'assise + Coussin de dossier  
102 x 138 cm + 102 x 38 cm



079008 + 079032

079008107 + 079032107

95079002

56079002000



DAYBED LEFT  
Daybed links  
Daybed izquierdo  
Daybed sinistro  
Daybed gauche  
23 kg 1,6 m<sup>3</sup>



079007107 + 079032107

SEAT CUSHION + BACK CUSHION + SIDE CUSHION  
Sitzkissen + Rückenkissen + Seitenkissen  
Cojín de asiento + Cojín de respaldo + Cojín lateral  
Cuscino seduta + Cuscino schienale + Cuscino laterale  
Coussin d'assise + Coussin de dossier + Coussin latéral  
102 x 136 cm + 136 x 38 cm + 39 x 31 x 6 cm



95079018

56079018000

DAYBED RIGHT  
Daybed rechts  
Daybed derecho  
Daybed destro  
Daybed droit  
23 kg 1,6 m<sup>3</sup>



079006107 + 079032107

SEAT CUSHION + BACK CUSHION + SIDE CUSHION  
Sitzkissen + Rückenkissen + Seitenkissen  
Cojín de asiento + Cojín de respaldo + Cojín lateral  
Cuscino seduta + Cuscino schienale + Cuscino laterale  
Coussin d'assise + Coussin de dossier + Coussin latéral  
102 x 136 cm + 136 x 38 cm + 39 x 31 x 6 cm



95079018

56079017000

BEACH CHAIR  
Sonnenliege  
Tumbona  
Letino  
Chaise longue  
19 kg 1,5 m<sup>3</sup>



079119107

CUSHION

Kissen  
Cojín  
Cuscino  
Coussin  
195 x 75 cm



95079119

56079119000

FOOTSTOOL / COFFEE TABLE  
Hocker / Kaffeetisch  
Reposapiés / Mesa de centro  
Pouf / Tavolino da salotto  
Repose-pieds / Table de salon  
102 x 102 cm  
8 kg 0,32 m<sup>3</sup>



079031107

SEAT CUSHION

Sitzkissen  
Cojín de asiento  
Cuscino seduta  
Coussin d'assise  
102 x 102 cm



95079031

56079031000

079031



Set: 079030107

MONOLITE TAUPE

Monolite taupe  
Monolite taupe  
Monolite taupe  
Monolite taupe  
39 kg



23379030308

56079030000

FOOTSTOOL / COFFEE TABLE  
Hocker / Kaffeetisch  
Reposapiés / Mesa de centro  
Pouf / Tavolino da salotto  
Repose-pieds / Table de salon  
68 x 102 cm  
7 kg 0,22 m<sup>3</sup>



079032107

SEAT CUSHION

Sitzkissen  
Cojín de asiento  
Cuscino seduta  
Coussin d'assise  
102 x 68 cm



95079032

56079032000

079032



Set: 079033107

MONOLITE TAUPE

Monolite taupe  
Monolite taupe  
Monolite taupe  
Monolite taupe  
19,5 kg



23379033308

56079033000

RECOMMENDED DECO CUSHIONS  
Empfohlene Dekokissen  
Cojines decoración recomendados  
Cuscini decorativi consigliati  
Coussins déco recommandés

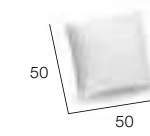

95050082

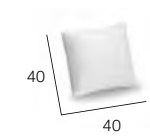

95050081

COFFEE TABLE

Kaffeetisch  
Mesa de centro  
Tavolino da salotto  
Table de salon  
68 x 126 cm  
15,5 kg 0,29 m<sup>3</sup>



079035205

56079035000

079035

COFFEE TABLE

Kaffeetisch  
Mesa de centro  
Tavolino da salotto  
Table de salon  
68 x 170 cm  
19 kg 0,38 m<sup>3</sup>



079037205

56079037000

079037

COFFEE TABLE

Kaffeetisch  
Mesa de centro  
Tavolino da salotto  
Table de salon  
ø 68 cm  
8,2 kg 0,17 m<sup>3</sup>



079036205

56079036000

079036

COFFEE TABLE

Kaffeetisch  
Mesa de centro  
Tavolino da salotto  
Table de salon  
ø 102 cm  
15,3 kg 0,38 m<sup>3</sup>



079034205

56079034000

079034

SIDE TABLE

Beistelltisch  
Mesa auxiliar  
Tavolino d'appoggio  
Table d'appoint  
35 x 50 cm  
5 kg 0,1 m<sup>3</sup>

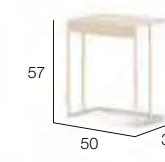

079039098

56079039000

079039098

Tabletop Ceramic



308 taupe

Coffee table 079030, Coffee table 079033

Tabletop Teak



205 teak

Coffee table 079035, Coffee table 079037  
Coffee table 079036, Coffee table 079034



TRAY  
Tablett  
Bandeja  
Vassoio  
Plateau



079099201

**EN** The **LOU collection** includes two different types of **coffee tables**. One features a base woven with DEDON Fiber and a tabletop made of Monolite Ipergres®, a frost-proof ceramic material that is non-absorbing and highly resistant to indirect tensile stress, impacts, scratches and abrasions. The other table comes in two different shapes and four sizes, the round ones overlapping the square ones. These coffee tables feature a premium teak tabletop on a base of powder-coated stainless steel.

The **LOU side table** consists of powder-coated stainless steel.

The **LOU tray** consists of cross-laminated teak veneer. To protect it from moisture, we recommend keeping it indoors when not in use.

**DE** Für die **LOU Kollektion** stehen zwei verschiedene **Kaffeetische** zur Auswahl. Eine Version besteht aus einer mit DEDON Faser geflochtenen Basis und einer Tischplatte aus Monolite Ipergres®, einem frostsicheren, wasserabweisenden Keramikmaterial mit ausgezeichneter Kratz- und Abriebfestigkeit. Der andere Tisch ist in zwei unterschiedlichen Formen und vier Größen erhältlich, wobei die runden die eckigen überlappen. Diese Kaffeetische bestehen aus einer hochwertigen Teakholz-Tischplatte und einem Gestell aus pulverbeschichtetem Edelstahl.

Der **LOU Beistelltisch** ist aus pulverbeschichtetem Edelstahl gefertigt. Das **LOU Tablett** besteht aus Teak-Schichtholz. Um es vor Feuchtigkeit zu schützen, sollte es in Innenräumen aufbewahrt werden.

**ES** La **colección LOU** dispone de dos versiones de **mesas de centro** diferentes. Una está realizada a base de tejido con fibra DEDON con un tablero hecho de Monolite Ipergres® es un material cerámico resistente a las heladas y hermético al agua, con una resistencia excelente contra los arañazos, la abrasión así como a la presión indirecta. La otra mesa se presenta en dos formas diferentes y cuatro tamaños en total, las mesas redondas se pueden colocar solapando las mesas rectangulares. Estas mesas de centro cuentan con un sobre de teca de alta calidad sobre una base de acero con acabado de pintura en polvo. La **mesa auxiliar LOU** está hecha de acero inoxidable con acabado de pintura en polvo. La **bandeja LOU** se compone de chapa de madera de teca laminada. Para protegerla contra la humedad, le recomendamos que, cuando no se utilice, la guarde en un espacio cerrado.

**IT** La **collezione LOU** include due diversi tipi di **tavolini da salotto**. Uno dispone di una base intrecciata con fibra DEDON e di un piano in Monolite Ipergres®, un materiale ceramico resistente al gelo, non assorbente e altamente resistente ai graffi e alle abrasioni. L'altro tavolo è disponibile in due diverse forme e quattro misure, in modo che quelli rotondi possano sovrapporsi a quelli quadrati. Questi tavolini da salotto presentano un piano in teak di prima qualità su una base in acciaio inox verniciata a polvere. Il **tavolino da salotto LOU** è in acciaio inox. Verniciato a polvere. Il **vassoio LOU** presenta uno strato di rivestimento in teak. Per proteggerlo dall'umidità dovrebbe essere conservato in un luogo interno.

**FR** La **collection LOU** comprend deux types de **tables de salon**. L'une possède une base tressée avec la fibre DEDON et un plateau en Monolite Ipergres®, un matériau céramique résistant au gel, imperméable et hautement résistant aux contraintes de traction indirectes, aux impacts, aux rayures et à l'abrasion. La seconde table est disponible en deux formes différentes et quatre tailles, les tables rondes recouvrant les tables carrées. Ces tables de salon comprennent un plateau de table en teck de grande qualité sur une base d'acier inoxydable laqué. Le **table d'appoint LOU** est en acier inoxydable thermolaqué. Le **plateau LOU** est en teck contreplaqué. Afin de le protéger de l'humidité, il est recommandé de le conserver à l'intérieur, lorsqu'il n'est pas utilisé.

# LOU

## OPTIONAL COMBINATIONS

### LOU Setting 01

- 1x **079006** – Right module, Seat cushion + Back cushion + Side cushion
- 1x **079008** – Center module, Seat cushion + Back cushion
- 1x **079009** – Corner module, Seat cushion + Corner back cushion
- 1x **079035** – Coffee table 68 x 126 cm, Teak top

Recommended deco cushions:  
**2x 95050081** – 40 x 40 cm  
**1x 95050082** – 50 x 50 cm

For inspiration please see page 176

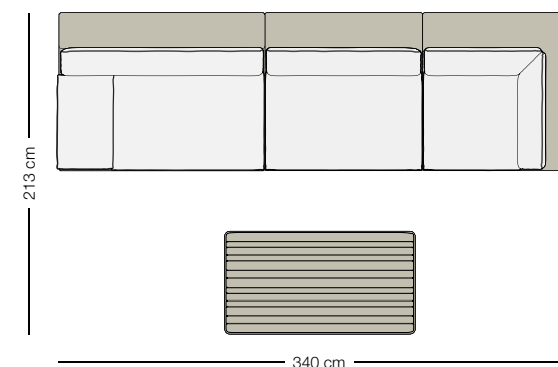

### LOU Setting 02

- 1x **079009** – Corner module, Seat cushion + Corner back cushion
- 1x **079010** – Curved module, Seat cushion + Back cushion
- 1x **079007** – Left module, Seat cushion + Back cushion + Side cushion
- 1x **079033** – Coffee table 68 x 102 cm, Monolite taupe top
- 1x **079036** – Coffee table ø 68 cm, Teak top

Recommended deco cushions:  
**2x 95050081** – 40 x 40 cm  
**1x 95050082** – 50 x 50 cm

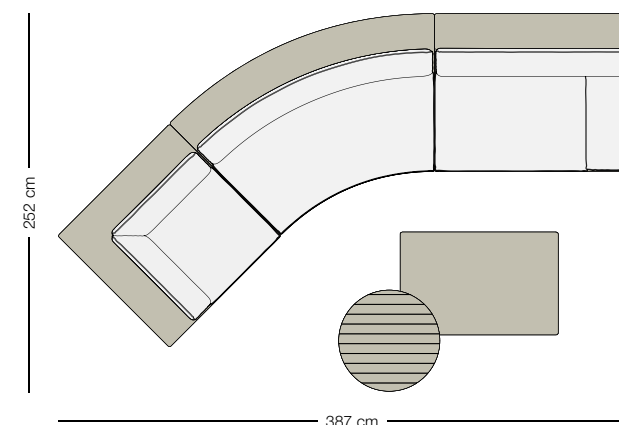

### LOU Setting 03

- 1x **079006** – Right module, Seat cushion + Back cushion + Side cushion
- 1x **079030** – Coffee table 102 x 102 cm, Monolite taupe top
- 2x **079008** – Center module, Seat cushion + Back cushion
- 1x **079009** – Corner module, Seat cushion + Corner back cushion
- 2x **079031** – Footstool 102 x 102 cm, Seat cushion
- 1x **079037** – Coffee table 68 x 170 cm, Teak top

Recommended deco cushions:  
**3x 95050081** – 40 x 40 cm  
**2x 95050082** – 50 x 50 cm

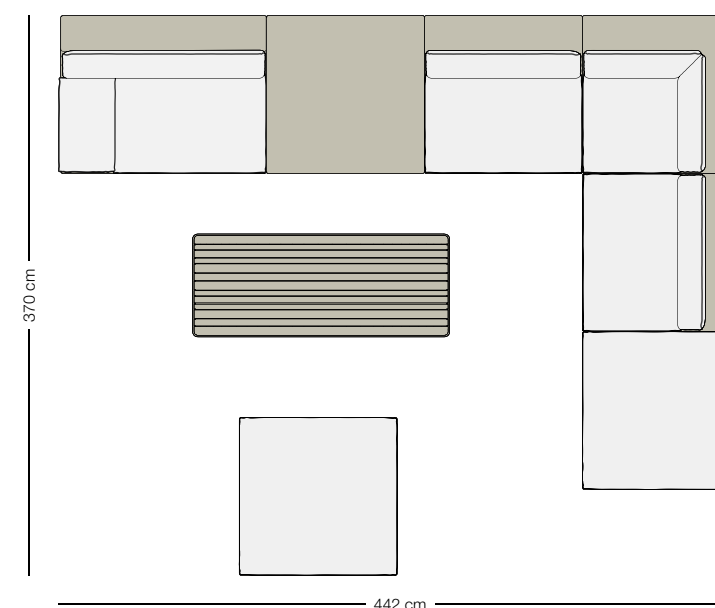





Right module  
Corner module  
Center module  
Left module  
Coffee table 65 x 110 cm  
Cushion: COOL dark gray 454

## Recommended combinations

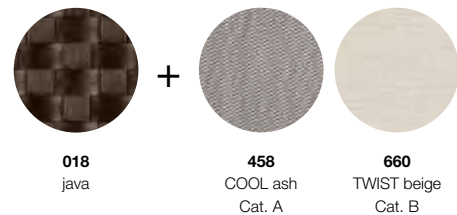

LOUNGE CHAIR  
Sessel  
Sillón bajo  
Poltrona club  
Fauteuil club  
21 kg 0,84 m³



029008

029008018

SEAT CUSHION + BACK CUSHION \*  
Sitzkissen + Rückenkissen  
Cojín de asiento + Cojín de respaldo  
Cuscino seduta + Cuscino schienale  
Coussin d'assise + Coussin de dossier  
90 x 75 cm + 90 x 34 cm



95029008

56029008000



029008066

PLUSH SEAT CUSHION + BACK CUSHION \*  
Plush Sitzkissen + Rückenkissen  
Plush cojín de asiento + Cojín de respaldo  
Plush cuscino seduta + Cuscino schienale  
Plush coussin d'assise + Coussin de dossier  
90 x 75 cm + 90 x 34 cm

95029208

LEFT MODULE  
Modul links  
Módulo izquierdo  
Modulo sinistro  
Module gauche  
19 kg 0,92 m³



029005

029005018

SEAT CUSHION + BACK CUSHION \*  
Sitzkissen + Rückenkissen  
Cojín de asiento + Cojín de respaldo  
Cuscino seduta + Cuscino schienale  
Coussin d'assise + Coussin de dossier  
111 x 75 cm + 111 x 34 cm



95029005

56029005000



029005066

PLUSH SEAT CUSHION + BACK CUSHION \*  
Plush Sitzkissen + Rückenkissen  
Plush cojín de asiento + Cojín de respaldo  
Plush cuscino seduta + Cuscino schienale  
Plush coussin d'assise + Coussin de dossier  
111 x 75 cm + 111 x 34 cm

95029205

RIGHT MODULE  
Modul rechts  
Módulo derecho  
Modulo destro  
Module droit  
19 kg 0,92 m³



029003

029003018

SEAT CUSHION + BACK CUSHION \*  
Sitzkissen + Rückenkissen  
Cojín de asiento + Cojín de respaldo  
Cuscino seduta + Cuscino schienale  
Coussin d'assise + Coussin de dossier  
111 x 75 cm + 111 x 34 cm



95029003

56029003000

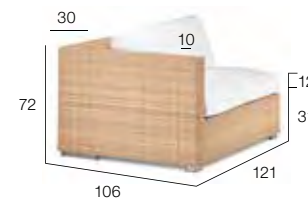

029003066

PLUSH SEAT CUSHION + BACK CUSHION \*  
Plush Sitzkissen + Rückenkissen  
Plush cojín de asiento + Cojín de respaldo  
Plush cuscino seduta + Cuscino schienale  
Plush coussin d'assise + Coussin de dossier  
111 x 75 cm + 111 x 34 cm

95029203

RECOMMENDED DECO CUSHIONS  
Empfohlene Dekokissen  
Cojines decoración recomendados  
Cuscini decorativi consigliati  
Coussins déco recommandés

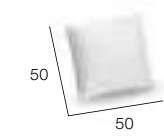

95050082

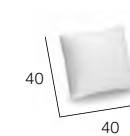

95050081



CENTER MODULE

Modul mitte  
Módulo centro  
Modulo centrale  
Module central  
11,5 kg 0,5 m³



SEAT CUSHION + BACK CUSHION \*  
Sitzkissen + Rückenkissen  
Cojín de asiento + Cojín de respaldo  
Cuscino seduta + Cuscino schienale  
Coussin d'assise + Coussin de dossier  
66 x 75 cm + 66 x 34 cm

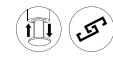

029001

029001018

95029001

56029001000



PLUSH SEAT CUSHION + BACK CUSHION \*  
Plush Sitzkissen + Rückenkissen  
Plush cojín de asiento + Cojín de respaldo  
Plush cuscino seduta + Cuscino schienale  
Plush coussin d'assise + Coussin de dossier  
66 x 75 cm + 66 x 34 cm

029001066

95029201

CENTER MODULE XXL

Modul mitte XXL  
Módulo centro XXL  
Modulo centrale XXL  
Module central XXL  
16 kg 0,84 m³



SEAT CUSHION + BACK CUSHION \*  
Sitzkissen + Rückenkissen  
Cojín de asiento + Cojín de respaldo  
Cuscino seduta + Cuscino schienale  
Coussin d'assise + Coussin de dossier  
110 x 75 cm + 110 x 34 cm\*

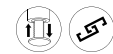

029002

029002018

95029002

56029002000



PLUSH SEAT CUSHION + BACK CUSHION \*  
Plush Sitzkissen + Rückenkissen  
Plush cojín de asiento + Cojín de respaldo  
Plush cuscino seduta + Cuscino schienale  
Plush coussin d'assise + Coussin de dossier  
110 x 75 cm + 110 x 34 cm

029002066

95029202

CURVED MODULE

Bogenmodul  
Módulo curvo  
Modulo curvo  
Module incurvé  
16 kg 1,16 m³



SEAT CUSHION + BACK CUSHION  
Sitzkissen + Rückenkissen  
Cojín de asiento + Cojín de respaldo  
Cuscino seduta + Cuscino schienale  
Coussin d'assise + Coussin de dossier  
127 x 83 cm + 127 x 34 cm

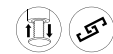

029006

029006018

95029006

56029006000

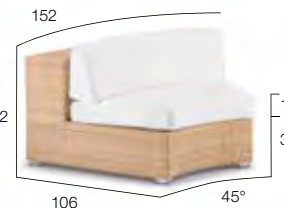

PLUSH SEAT CUSHION + BACK CUSHION  
Plush Sitzkissen + Rückenkissen  
Plush cojín de asiento + Cojín de respaldo  
Plush cuscino seduta + Cuscino schienale  
Plush coussin d'assise + Coussin de dossier  
127 x 83 cm + 127 x 34 cm

029006066

95029206

CORNER MODULE

Eckmodul  
Módulo esquina  
Modulo d'angolo  
Module d'angle  
18 kg 0,81 m³



SEAT CUSHION + CORNER BACK CUSHION \*  
Sitzkissen + Rückenkissen über Eck  
Cojín de asiento + Cojín de respaldo de esquina  
Cuscino seduta + Cuscino schienale angolare  
Coussin d'assise + Coussin de dossier formant un angle  
75 x 75 cm + 150 x 34 cm



029007

029007018

95029007

56029007000



PLUSH SEAT CUSHION + CORNER BACK CUSHION \*  
Plush Sitzkissen + Rückenkissen über Eck  
Plush cojín de asiento + Cojín de respaldo de esquina  
Plush cuscino seduta + Cuscino schienale angolare  
Plush coussin d'assise + Coussin de dossier formant un angle  
75 x 75 cm + 150 x 34 cm

029007066

95029207

SEAT CUSHION + ONE-SIDED BACK CUSHION \*  
Sitzkissen + 1-seitiges Rückenkissen  
Cojín de asiento + Cojín de respaldo de un lado  
Cuscino seduta + Cuscino schienale su un solo lato  
Coussin d'assise + Coussin pour un côté du dossier  
75 x 75 cm + 75 x 34 cm

95029017

PLUSH SEAT CUSHION + ONE-SIDED BACK CUSHION \*  
Plush Sitzkissen + 1-seitiges Rückenkissen  
Plush cojín de asiento + Cojín de respaldo de un lado  
Plush cuscino seduta + Cuscino schienale su un solo lato  
Plush coussin d'assise + Coussin pour un côté du dossier  
75 x 75 cm + 75 x 34 cm

95029217

DAYBED

Daybed  
Daybed  
Daybed  
Daybed  
26 kg 1,71 m³



CUSHION + BACK CUSHION \*\*  
Kissen + Rückenkissen  
Cojín + Cojín de respaldo  
Cuscino + Cuscino schienale  
Coussin + Coussin de dossier  
110 x 186 cm + 110 x 35 cm



029002 + 029037

029002018 + 029037018

95029018

56029018000



PLUSH SEAT CUSHION + BACK CUSHION \*\*  
Plush Sitzkissen + Rückenkissen  
Plush cojín de asiento + Cojín de respaldo  
Plush cuscino seduta + Cuscino schienale  
Plush coussin d'assise + Coussin de dossier  
110 x 186 cm + 110 x 35 cm

029002066 + 029037066

95029218

**EN** Color variations within the fiber give natural fiber tones such as bleach and java their lively and charming look while ensuring that every piece of furniture woven with them is unique.

**DE** Unsere natürlichen Faserfarben wie bleach und java leben von der Farbvielfalt innerhalb der Faserstruktur. Dieses lebendige und attraktive Farbenspiel ist der Grund dafür, dass jedes Möbelstück einzigartig ist und keines dem anderen gleicht.

**ES** Los tonos de nuestras fibras naturales, como por ejemplo, bleach y java, subsisten en las variaciones de color de la estructura de la fibra. Este juego de colores vivaz y fascinante es el motivo por el cual cada mueble es una pieza única y no se asemeja a otro.

**IT** La varietà dei colori presenti all'interno della struttura della fibra mette in risalto i colori naturali delle fibre Bleach e Java. Questo vivace ed interessante gioco di colori rende unico ogni mobile.

**FR** Nos couleurs naturelles de fibres comme bleach et java profitent de la diversité chromatique dans la structure des fibres elle-même. Ce jeu de couleurs dynamique et plaisant est la raison pour laquelle chacun de nos meubles est unique.

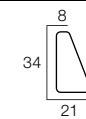

\* **EN** Back cushion **DE** Rückenkissen **ES** Cojín de respaldo **IT** Cuscino schienale **FR** Coussin de dossier



\*\* **EN** Back cushion **DE** Rückenkissen **ES** Cojín de respaldo **IT** Cuscino schienale **FR** Coussin de dossier



BEACH CHAIR \*  
Sonnenliege  
Tumbona  
Lettino  
Chaise longue  
22,5 kg 0,4 m<sup>3</sup>



029119018

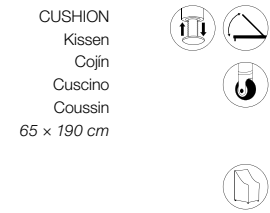

CUSHION  
Kissen  
Cojín  
Cuscino  
Coussin  
65 x 190 cm

029119

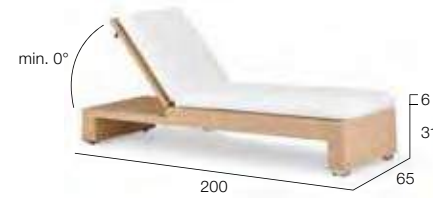

029119066

95029019 56029019000

PLUSH CUSHION  
Plush Kissen  
Plush cojín  
Plush cuscino  
Plush coussin  
65 x 190 cm

FOOTSTOOL / COFFEE TABLE  
Hocker / Kaffeetisch  
Reposapiés / Mesa de centro  
Pouf / Tavolino da salotto  
Repose-pieds / Table de salon  
110 x 110 cm  
10,5 kg 0,38 m<sup>3</sup>



029037018

SEAT CUSHION  
Sitzkissen  
Cojín de asiento  
Cuscino seduta  
Coussin d'assise  
110 x 110 cm

95029037

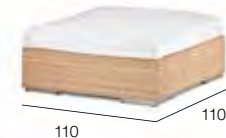

029037066

PLUSH SEAT CUSHION  
Plush Sitzkissen  
Plush cojín de asiento  
Plush cuscino seduta  
Plush coussin d'assise  
110 x 110 cm

95029219

CLEAR GLASS TOP  
Klarglasplatte  
Sobre de cristal transparente  
Piano in vetro trasparente  
Plaque en verre clair  
17,5 kg



Set: 029038066

95029237 56029030000

029037



Set: 029038018



22229037000 56029037000

FOOTSTOOL / COFFEE TABLE  
Hocker / Kaffeetisch  
Reposapiés / Mesa de centro  
Pouf / Tavolino da salotto  
Repose-pieds / Table de salon  
65 x 110 cm  
7 kg 0,22 m<sup>3</sup>



029035018

SEAT CUSHION  
Sitzkissen  
Cojín de asiento  
Cuscino seduta  
Coussin d'assise  
65 x 110 cm

95029035



029035066

PLUSH SEAT CUSHION  
Plush Sitzkissen  
Plush cojín de asiento  
Plush cuscino seduta  
Plush coussin d'assise  
65 x 110 cm

95029235

CLEAR GLASS TOP  
Klarglasplatte  
Sobre de cristal transparente  
Piano in vetro trasparente  
Plaque en verre clair  
10,5 kg



Set: 029036066

95029235 56029031000

029035



Set: 029036018



22229035000 56029035000

## Tabletop Glass

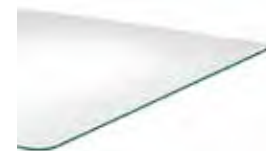

000 clear glass

EN This item is also available with hook-catching mechanism upon request.

DE Dieser Artikel ist auf Anfrage auch mit Stufenverstellung erhältlich.

ES Bajo pedido este artículo también está disponible con un mecanismo de ajuste escalonado.

IT Questo articolo è disponibile su richiesta anche con meccanismo di regolazione reclinabile.

FR Cet article est disponible, sur demande, avec un mécanisme de réglage du niveau d'inclinaison.

## CUSHION OPTIONS

Cushion (A)

Plush cushion (B)

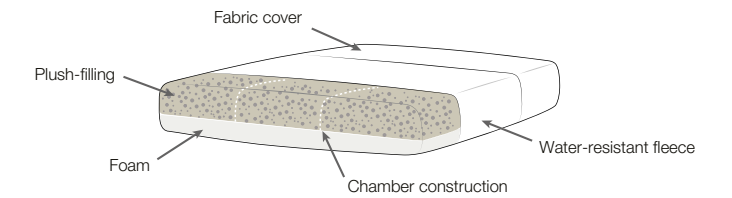
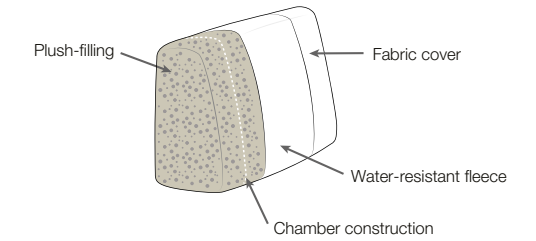
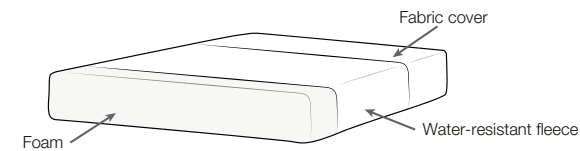
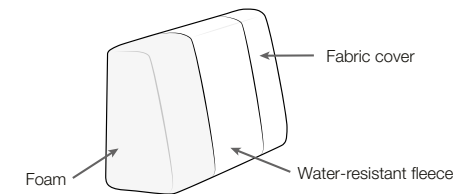

EN The LOUNGE modules come with two cushion options. Cushion (A) with its clean lines provides sturdy sitting comfort, while the plush version (B) offers a more cozy experience with softer lines. Shake the plush cushions occasionally to ensure that they retain maximum comfort.

DE LOUNGE Module bieten zwei Kissenoptionen: Das Kissen (A) zeichnet sich durch einen stabilen Sitzkomfort und eine geradlinige Anmutung aus, während die Plush-Kissenversion (B) ein komfortables Sitzgefühl vermittelt und sich in weicheren Formen darstellt. Schütteln Sie die Plush Kissen zwischendurch auf, damit sie nicht an Komfort verlieren.

ES Los módulos LOUNGE ofrecen dos tipos de cojines: el cojín (A) se caracteriza por su confort y estabilidad y por su aspecto rectilíneo, mientras que la versión "Plush" del cojín (B) proporciona una sensación de comodidad al sentarse, y muestra formas más suaves. Agite los cojines "Plush" de vez en cuando a fin de que conserven el máximo confort.

IT I moduli LOUNGE offrono due opzioni di cuscini: il cuscino (A) è caratterizzato da una seduta stabile e confortevole e da un aspetto rettilineo, mentre i cuscini Plush della versione (B) trasmettono una sensazione di comodità della seduta e presentano forme più morbide. Scuotere di tanto in tanto i cuscini "Plush" per garantire sempre il massimo confort.

FR Avec les modules LOUNGE, deux types de coussins sont en option : plus de stabilité et un design plus graphique pour la version (A), davantage de confort et des formes plus douces pour les coussins en peluche de la version (B). Secouez de temps en temps les coussins „Plush“ pour vous assurer qu'ils conservent tout leur confort.



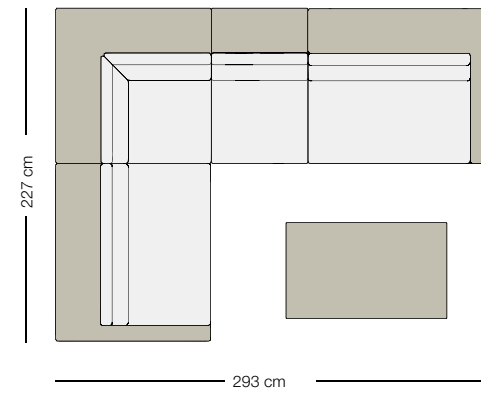

### LOUNGE Setting 01

- 1x 029003 – Right module, Seat cushion + Back cushion
- 1x 029007 – Corner module, Seat cushion + Corner back cushion
- 1x 029001 – Center module, Seat cushion + Back cushion
- 1x 029005 – Left module, Seat cushion + Back cushion
- 1x 029036 – Coffee table 65 x 110 cm, Clear glass top

Recommended deco cushions:  
 2x 95050081 – 40 x 40 cm  
 1x 95050082 – 50 x 50 cm

For inspiration please see page 182

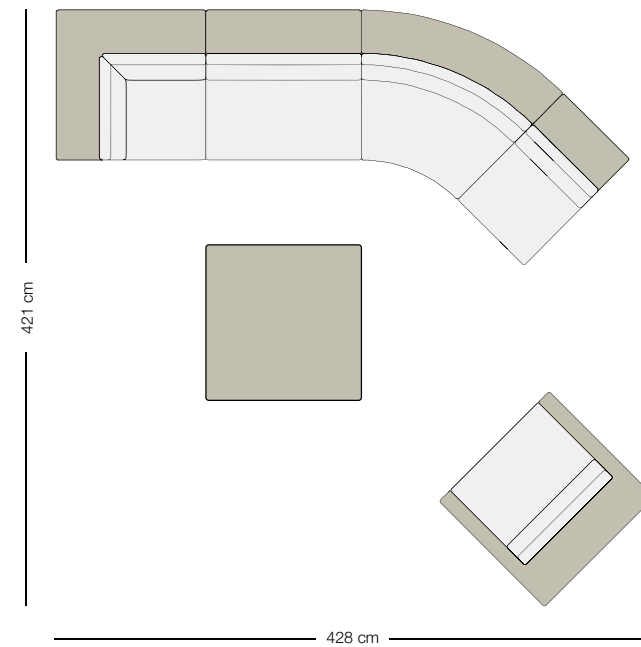

### LOUNGE Setting 02

- 1x 029008 – Lounge chair, Seat cushion + Back cushion
- 1x 029001 – Center module, Seat cushion + Back cushion
- 1x 029006 – Curved module, Seat cushion + Back cushion
- 1x 029002 – Center module XXL, Seat cushion + Back cushion
- 1x 029007 – Corner module, Seat cushion + Corner back cushion
- 1x 029038 – Coffee table 110 x 110 cm, Clear glass top

Recommended deco cushions:  
 2x 95050081 – 40 x 40 cm  
 1x 95050082 – 50 x 50 cm

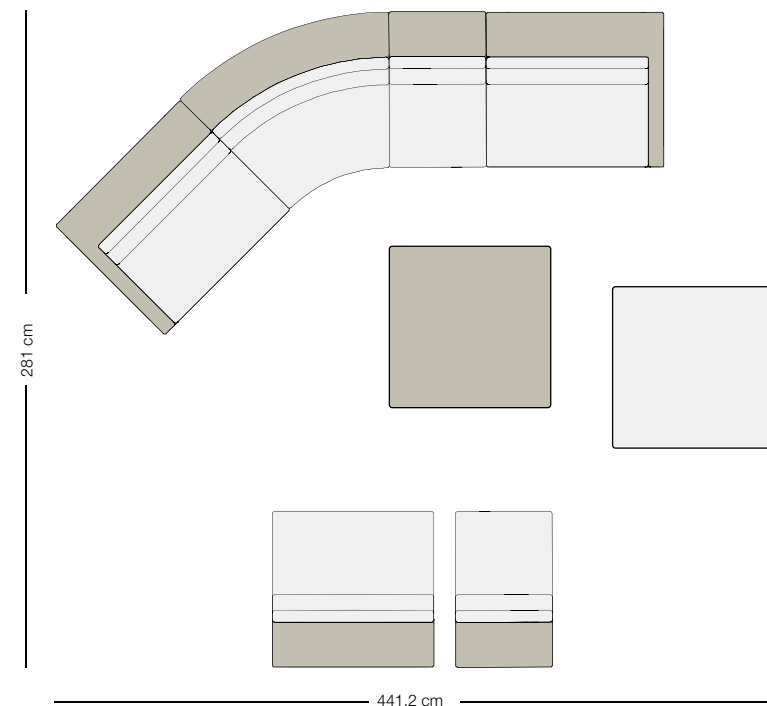

### LOUNGE Setting 03

- 1x 029003 – Right module, Seat cushion + Back cushion
- 1x 029006 – Curved module, Seat cushion + Back cushion
- 2x 029001 – Center module, Seat cushion + Back cushion
- 1x 029005 – Left module, Seat cushion + Back cushion
- 1x 029038 – Coffee table 110 x 110 cm, Clear glass top
- 1x 029037 – Footstool 110 x 110 cm, Seat cushion
- 1x 029002 – Center module XXL, Seat cushion + Back cushion

Recommended deco cushions:  
 3x 95050081 – 40 x 40 cm  
 2x 95050082 – 50 x 50 cm

For inspiration please see page 78



LOUNGE corner module  
 Plush cushion: COOL dark gray 454





1x Coffee table  
2x Side table

## Material

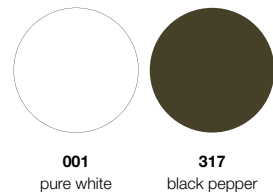

SIDE TABLE  
Beistelltisch  
Mesa auxiliar  
Tavolino d'appoggio  
Table d'appoint  
**ø 40 cm**  
5,6 kg 0,08 m<sup>3</sup>



066133001



066133317

066133

COFFEE TABLE  
Kaffeetisch  
Mesa de centro  
Tavolino da salotto  
Table de salon  
**ø 80 cm**  
18,9 kg 0,28 m<sup>3</sup>



066182001



066182317

066182

## Tabletops Powder-Coated Metal



001 pure white



317 black pepper

**EN** Catalytic treated steel tabletops and stainless steel legs. Polyester powder-coat finishing helps to make the tabletops and legs resistant to strong weather conditions.

**DE** Katalytisch behandelte Tischplatten aus Stahl und Beine aus rostfreiem Stahl. Polyester-pulverbeschichtete Verarbeitung macht die Tischplatte und die Beine gegen schlechte Witterungsbedingungen unempfindlich.

**ES** Mesa con tope de acero con tratamiento catalítico y patas en acero inoxidable. Su acabado en revestimiento de polvo de poliéster permite que el tope y las patas de la mesa resistan las duras condiciones meteorológicas.

**IT** Piano del tavolo in acciaio e gambe in acciaio inossidabile con trattamento di cataforesi. La verniciatura finale con polvere di poliestere aiuta a incrementare la resistenza del piano e delle gambe del tavolo in condizioni metereologiche estreme.

**FR** Plateaux de table en acier traité catalytique et pieds en acier inoxydable. La finition polyester thermolaqué rend le plateau et les pieds plus résistants aux intempéries.





Rocking chair, arabica  
Cushion: COOL ash 458  
Lounge chair, baltic  
Cushion: TABRIZ topaz/blue 568  
Footstool, baltic

Fiber by item

Lounge chair, Wing chair, Rocking chair,  
Footstool, Daybed, Armchair

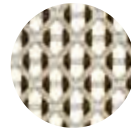

115  
pepper



126  
arabica

Lounge chair, Wing chair,  
Rocking chair, Footstool

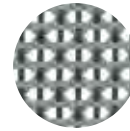

141  
baltic

Lounge chair, Wing chair,  
Rocking chair, Footstool, Daybed

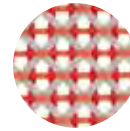

112  
spice

Armchair

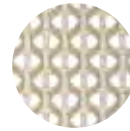

140  
sea salt

Recommended combinations

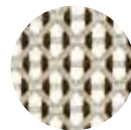

115  
pepper

+



452  
COOL taupe  
Cat. A



661  
TWIST sand  
Cat. B



126  
arabica

+

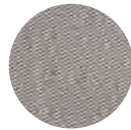

458  
COOL ash  
Cat. A

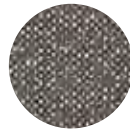

567  
TABRIZ  
taupe/gray  
Cat. B

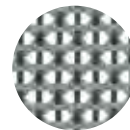

141  
baltic

+



458  
COOL ash  
Cat. A

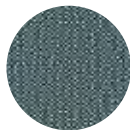

568  
TABRIZ  
topaz/blue  
Cat. B

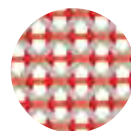

112  
spice

+



452  
COOL taupe  
Cat. A



661  
TWIST sand  
Cat. B



140  
sea salt

+



452  
COOL taupe  
Cat. A



661  
TWIST sand  
Cat. B

WING CHAIR  
Hochlehner  
Sillón orejero  
Poltrona con schienale alto  
Fauteuil bergère  
8,6 kg 0,92 m³

085004



085004115



085004126



085004141



085004112

SEAT CUSHION  
Sitzkissen  
Cojín de asiento  
Cuscino seduta  
Coussin d'assise  
95 x 65 cm

95085016



97 89 107

CUSHION  
Polsterauflage  
Cojín  
Cuscino  
Coussin matelassé  
105 x 140 cm

95085004

56085004000

ROCKING CHAIR  
Schaukelstuhl  
Mecedora  
Sedia a dondolo  
Fauteuil à bascule  
9,9 kg 1,01 m³

085008



085008115



085008126

SEAT CUSHION  
Sitzkissen  
Cojín de asiento  
Cuscino seduta  
Coussin d'assise  
95 x 65 cm

95085016



91 102 107

CUSHION  
Polsterauflage  
Cojín  
Cuscino  
Coussin matelassé  
105 x 140 cm

95085004

56085004000



ROCKING CHAIR  
Schaukelstuhl  
Mecedora  
Sedia a dondolo  
Fauteuil à bascule  
9,9 kg 1,01 m³



085008141

SEAT CUSHION  
Sitzkissen  
Cojín de asiento  
Cuscino seduta  
Coussin d'assise  
95 x 65 cm

95085016



CUSHION  
Polsterauflage  
Cojín  
Cuscino  
Coussin matelassé  
105 x 140 cm

95085004

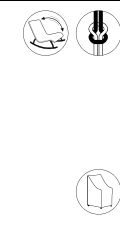

56085004000



085008112



LOUNGE CHAIR  
Sessel  
Sillón bajo  
Poltrona club  
Fauteuil club  
7,6 kg 0,25 m³



085006115

SEAT CUSHION  
Sitzkissen  
Cojín de asiento  
Cuscino seduta  
Coussin d'assise  
95 x 65 cm

95085016



CUSHION  
Polsterauflage  
Cojín  
Cuscino  
Coussin matelassé  
110 x 115 cm

95085006

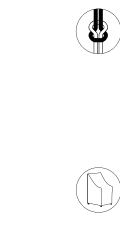

56085006000



085006126



085006141



085006112



FOOTSTOOL  
Hocker  
Taburete  
Pouf  
Repose-pieds  
2,6 kg 0,11 m³



085032115

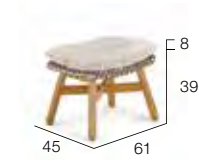

SEAT CUSHION  
Sitzkissen  
Cojín de asiento  
Cuscino seduta  
Coussin d'assise  
62 x 45 cm

95085032



56085032000



085032126



085032141



085032112



RECOMMENDED NUMBER OF DECO CUSHIONS FOR LOUNGE CHAIR, WING CHAIR AND ROCKING CHAIR WITH SEAT CUSHION.  
Empfohlene Dekokissenmenge für Sessel, Hochlehner und Schaukelstuhl mit Sitzkissen.  
Número de cojines decoración recomendados para sillón bajo, sillón orejero y mecedora con cojín de asiento.  
Numero di cuscini decorativi per poltrona club, poltrona con schienale alto e sedia a dondolo con cuscino seduta.  
Nombre de coussins déco recommandé pour fauteuil club, fauteuil bergère et fauteuil à bascule avec coussin d'assise.

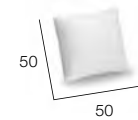

1x 95050082

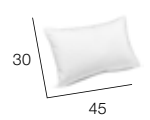

1x 95050089



COFFEE TABLE  
Kaffeetisch  
Mesa de centro  
Tavolino da salotto  
Table de salon  
Ø 70 cm  
17,2 kg 0,17 m³



085038300



34,5

Ø 70 cm

085038341



56085038000

085038



085038308

SIDE TABLE  
Beistelltisch  
Mesa auxiliar  
Tavolino d'appoggio  
Table d'appoint  
Ø 50 cm  
9,2 kg 0,11 m³



085036300



45,5

Ø 50 cm

085036341



56085036000

085036



085036308

SIDE TABLE  
Beistelltisch  
Mesa auxiliar  
Tavolino d'appoggio  
Table d'appoint  
Ø 35 cm  
6,2 kg 0,06 m³



085034300



50,5

Ø 35 cm

085034341



56085034000

085034



085034308

Tabletop Ceramic



300 chalk



341 black



308 taupe

DAYBED  
Daybed  
Daybed  
Daybed  
Daybed  
14,4 kg 1,35 m³



085018115

085018



085018126



085018112



80

159

8

35

106

CUSHION  
Polsterauflage  
Cojín  
Cuscino  
Coussin matelassé  
105 x 140 cm



95085018

56085018000

**EN** The MBRACE collection comes in a mix of materials. The seats consist of DEDON Fiber woven over an aluminum frame, while the bases and dining tables are made of premium teak. The **cushions** of the wing chair, lounge chair, rocking chair and daybed are quilted, which keeps the filling in place and supports the longevity of their luxurious embrace. While the covers cannot be removed, the complete cushions may be washed by hand at 30°C. Cushions of wing chair, lounge chair and rocking chair and the back cushion of armchair come with a cushion holder, while seat cushions do not. The protective cover is tailored to protect the fiber seat and cushions only. The **tabletops** of the side tables are made of Monolite Ipergres®, a frost-proof ceramic material that is non-absorbing and highly resistant to indirect tensile stress, impacts, scratches and abrasion.

**DE** Die Kollektion MBRACE besteht aus einem Mix aus Materialien: Die Sitzflächen sind aus DEDON Faser gefertigt, die auf einem Aluminiumrahmen geflochten ist. Die Untergestelle und Esstische sind aus hochwertigen Teakholz gefertigt. Die **Kissen** vom Hochlehner, Sessel, Schaukelstuhl und Daybed sind gesteppt, um die weiche Füllung zu unterstützen. Daher können die Kissenhüllen nicht abgezogen werden. Die Polsterauflagen von Hochlehner, Sessel und Schaukelstuhl, sowie das Rückenkissen vom Armlehnstuhl sind mit Kissenhaltern ausgestattet, die Sitzkissen nicht. Die **Tischplatten** der Beistelltische werden aus Monolite Ipergres® gefertigt, einem frostsicheren, wasserabweisenden Keramikmaterial mit ausgezeichneter Kratz- und Abriebfestigkeit.

**ES** La colección MBRACE ofrece una interesante mezcla de materiales. La superficie de los asientos está fabricada con tejido trenzado DEDON sobre una estructura de aluminio, mientras que las bases y las mesas comedor son de teca de excelente calidad. Los **cojines** de los sillones orejeros, sillones bajos, mecedoras y daybeds están capitonados, lo cual ayuda a mantener el suave relleno en su lugar y prolonga su comodidad. Si bien las fundas no son extraíbles, es posible lavar los cojines enteros a mano a 30 °C. Los cojines del respaldo de los sillones orejeros, bajos, mecedoras, así como de las sillas con brazos tienen un lazo para su sujeción, mientras que los cojines del asiento no lo tienen. La funda protectora está diseñada para proteger las sillas de fibra y los cojines. Los **tableros de las mesas** auxiliares están hechos de Monolite Ipergres®, un material de cerámica resistente a las heladas, no absorbente y que ofrece una excelente resistencia al peso, a los golpes, a los arañazos y a la abrasión.

**IT** La collezione MBRACE è offerta in un mix di materiali. Le sedute sono in fibra DEDON, intrecciata su un telaio in alluminio, mentre le basi e i tavoli da pranzo sono in teak di alta qualità. I **cuscini** della poltrona con schienale alto, della poltrona lounge, della sedia a dondolo e del daybed sono trapuntati per sostenere l'imbottitura e favorire la longevità del suo lussuoso abbraccio. I cuscini non sono sfoderabili, ma possono essere lavati a mano a 30°C. I cuscini delle poltrone con schienale alto, delle poltrone lounge, delle poltrone a dondolo e il cuscino dello schienale delle poltrone sono dotati di un supporto antiscivolo, che invece non è previsto per le sedute. La fodera ha la sola funzione di proteggere la seduta in fibra e il cuscino. **I piani dei tavolini** d'appoggio sono in Monolite Ipergres®, un materiale ceramico antigelo, impermeabile, caratterizzato da un'eccellente resistenza alle sollecitazioni indirette, agli urti, ai graffi e all'abrasione.

**FR** La collection MBRACE est le résultat d'un mélange de matières et de matériaux. Les fauteuils sont composés de fibre DEDON tressée sur un cadre en aluminium, tandis que les bases et les tables repas sont en teck de qualité supérieure. Les **coussins** du fauteuil bergère, du fauteuil club, du fauteuil à bascule et du daybed sont matelassés, afin de maintenir leur garniture en place et de garantir la longévité de leur étreinte généreuse. Bien que les housses ne peuvent pas être retirées, les coussins entiers sont, eux, lavables à la main à 30°C. Contrairement aux coussins d'assise, les coussins matelassés du fauteuil bergère, du fauteuil club et du fauteuil à bascule, ainsi que le coussin de dossier du fauteuil repas sont équipés de sangles de fixation. La housse de protection est uniquement destinée à protéger les fauteuils et les coussins. Les **plateaux de tables** d'appoint sont en Monolite Ipergres®, un matériau céramique résistant au gel, non absorbant et hautement résistant aux contraintes de traction indirectes, aux chocs, aux rayures et à l'abrasion.



ARMCHAIR  
 Armlehnstuhl  
 Silla con brazos  
 Poltrona pranzo  
 Fauteuil repas  
 5,6 kg 0,3 m³



085001115

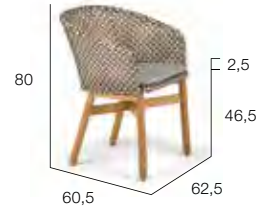

SEAT CUSHION  
 Sitzkissen  
 Cojín de asiento  
 Cuscino seduta  
 Coussin d'assise  
 46,5 x 46,5 cm



95085001

SEAT CUSHION + BACK CUSHION  
 Sitzkissen + Rückenkissen  
 Cojín de asiento + Cojín de respaldo  
 Cuscino seduta + Cuscino schienale  
 Coussin d'assise + Coussin de dossier  
 46,5 x 46,5 cm + 58,5 x 36,5 cm



95085003

56085001000



085001126



085001140



DINING TABLE  
 Esstisch  
 Mesa Comedor  
 Tavolo pranzo  
 Table repas  
 200 x 90 cm  
 40 kg 1,35 m³



085065205



4+2



56085065000

DINING TABLE  
 Esstisch  
 Mesa Comedor  
 Tavolo pranzo  
 Table repas  
 270 x 90 cm  
 51 kg 1,83 m³



085055205



6+2



56085055000

085055  
 Tabletop Teak



205 Teak



MBRACE Armchair arabica  
 Cushion: COOL taupe





Right module XXL  
Daybed left  
Cushion: COOL taupe 452  
Coffee table 90 x 90 cm

Recommended combinations

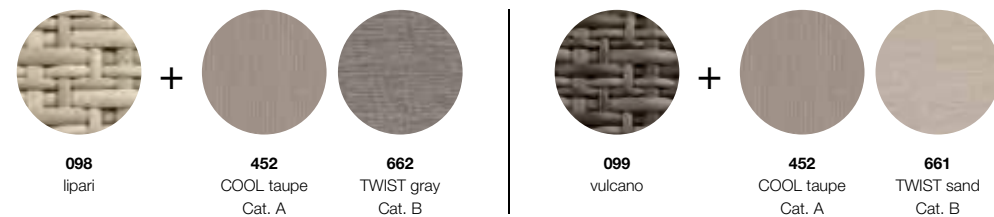

LOUNGE CHAIR  
Sessel  
Sillón bajo  
Poltrona club  
Fauteuil club  
28 kg 0,73 m³



067001098



067001099

SEAT CUSHION + BACK CUSHION  
Sitzkissen + Rückenkissen  
Cojín de asiento + Cojín de respaldo  
Cuscino seduta + Cuscino schienale  
Coussin d'assise + Coussin de dossier  
69 x 65 cm + 259 x 48 cm



067001

95067001

56067001000

LEFT MODULE  
Modul links  
Módulo izquierdo  
Modulo sinistro  
Module gauche  
29 kg 0,99 m³



067005098



067005099

SEAT CUSHION + BACK CUSHIONS  
Sitzkissen + Rückenkissen  
Cojín de asiento + Cojines de respaldo  
Cuscino seduta + Cuscini schienale  
Coussin d'assise + Coussins de dossier  
132 x 65 cm + 228 x 48 cm



067005

95067005

56067005000

RIGHT MODULE  
Modul rechts  
Módulo derecho  
Modulo destro  
Module droit  
29 kg 0,99 m³



067003098



067003099

SEAT CUSHION + BACK CUSHIONS  
Sitzkissen + Rückenkissen  
Cojín de asiento + Cojines de respaldo  
Cuscino seduta + Cuscini schienale  
Coussin d'assise + Coussins de dossier  
132 x 65 cm + 228 x 48 cm



067003

95067003

56067003000

LEFT MODULE XXL  
Modul links XXL  
Módulo izquierdo XXL  
Modulo sinistro XXL  
Module gauche XXL  
35 kg 1,41 m³



067006098



067006099

SEAT CUSHION + BACK CUSHIONS  
Sitzkissen + Rückenkissen  
Cojín de asiento + Cojines de respaldo  
Cuscino seduta + Cuscini schienale  
Coussin d'assise + Coussins de dossier  
197 x 65 cm + 293 x 48 cm



067006

95067006

56067006000

RIGHT MODULE XXL  
Modul rechts XXL  
Módulo derecho XXL  
Modulo destro XXL  
Module droit XXL  
35 kg 1,41 m³



067004098



067004099

SEAT CUSHION + BACK CUSHIONS  
Sitzkissen + Rückenkissen  
Cojín de asiento + Cojines de respaldo  
Cuscino seduta + Cuscini schienale  
Coussin d'assise + Coussins de dossier  
197 x 65 cm + 293 x 48 cm



067004

95067004

56067004000

CENTER MODULE  
Modul mitte  
Módulo centro  
Modulo centrale  
Module central  
24 kg 0,83 m³



067011098



067011099

SEAT CUSHION + BACK CUSHIONS  
Sitzkissen + Rückenkissen  
Cojín de asiento + Cojines de respaldo  
Cuscino seduta + Cuscini schienale  
Coussin d'assise + Coussins de dossier  
130 x 65 cm + 130 x 48 cm



067011

95067011

56067011000

RECOMMENDED DECO CUSHIONS  
Empfohlene Dekokissen  
Cojines decoración recomendados  
Cuscini decorativi consigliati  
Coussins déco recommandés

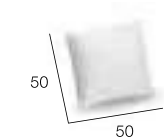

95050082

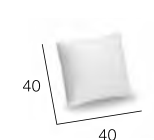

95050081



CENTER MODULE XXL  
Modul mitte XXL  
Módulo centro XXL  
Modulo centrale XXL  
Module central XXL  
31 kg 1,25 m³



067012098



067012099

SEAT CUSHION + BACK CUSHIONS  
Sitzkissen + Rückenkissen  
Cojín de asiento + Cojines de respaldo  
Cuscino seduta + Cuscini schienale  
Coussin d'assise + Coussins de dossier  
195 x 65 cm + 195 x 48 cm

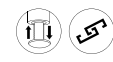

067012

95067012

56067012000

4-SEATER  
4er-Sofa  
Sofá 4 plazas  
Divano 4 posti  
Canapé 4 places  
39 kg 1,57 m³



067015098



067015099

SEAT CUSHION + BACK CUSHIONS  
Sitzkissen + Rückenkissen  
Cojín de asiento + Cojines de respaldo  
Cuscino seduta + Cuscini schienale  
Coussin d'assise + Coussins de dossier  
199 x 65 cm + 390 x 48 cm



067015

95067015

56067015000

DAYBED LEFT  
Daybed links  
Daybed izquierdo  
Daybed sinistro  
Daybed gauche  
28,5 kg 0,99 m³



067017098

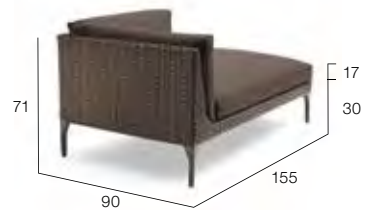

067017099

SEAT CUSHION + BACK CUSHION  
Sitzkissen + Rückenkissen  
Cojín de asiento + Cojín de respaldo  
Cuscino seduta + Cuscino schienale  
Coussin d'assise + Coussin de dossier  
130 x 90 cm + 163 x 48 cm

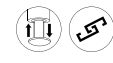

067017

95067017

56067017000

DAYBED RIGHT  
Daybed rechts  
Daybed derecho  
Daybed destro  
Daybed droit  
28,5 kg 0,99 m³



067018098



067018099

SEAT CUSHION + BACK CUSHION  
Sitzkissen + Rückenkissen  
Cojín de asiento + Cojín de respaldo  
Cuscino seduta + Cuscino schienale  
Coussin d'assise + Coussin de dossier  
130 x 90 cm + 163 x 48 cm

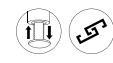

067018

95067018

56067018000

FOOTSTOOL / COFFEE TABLE  
Hocker / Kaffeetisch  
Reposapiés / Mesa de centro  
Pouf / Tavolino da salotto  
Repose-pieds / Table de salon  
90 x 90 cm  
18 kg 0,24 m³



067016098

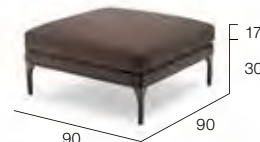

067016099

SEAT CUSHION  
Sitzkissen  
Cojín de asiento  
Cuscino seduta  
Coussin d'assise  
90 x 90 cm

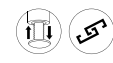

067016

95067016

56067030000



Set: 067116098



Set: 067116099

HPL LIPARI  
HPL lipari  
HPL lipari  
HPL lipari  
HPL lipari  
6,6 kg

HPL VULCANO  
HPL vulcano  
HPL vulcano  
HPL vulcano  
HPL vulcano  
6,6 kg

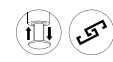

Set: 067216098



Set: 067216099

GLASS LIPARI  
Glas lipari  
Sobre de cristal lipari  
Piano in vetro lipari  
Plaque en verre lipari  
13,5 kg

GLASS VULCANO  
Glas vulcano  
Sobre de cristal vulcano  
Piano in vetro vulcano  
Plaque en verre vulcano  
13,5 kg



FOOTSTOOL / COFFEE TABLE  
Hocker / Kaffeetisch  
Reposapiés / Mesa de centro  
Pouf / Tavolino da salotto  
Repose-pieds / Table de salon  
90 x 130 cm  
22 kg 0,35 m³



067013098



067013099

SEAT CUSHION  
Sitzkissen  
Cojín de asiento  
Cuscino seduta  
Coussin d'assise  
90 x 130 cm



067013

95067013

56067031000

HPL LIPARI  
HPL lipari  
HPL lipari  
HPL lipari  
9,9 kg

HPL VULCANO  
HPL vulcano  
HPL vulcano  
HPL vulcano  
9,9 kg



Set: 067113098



Set: 067113099

24467013304

24467013305

56067013000

GLASS LIPARI  
Glas lipari  
Sobre de cristal lipari  
Piano in vetro lipari  
Plaque en verre lipari  
20 kg

GLASS VULCANO  
Glas vulcano  
Sobre de cristal vulcano  
Piano in vetro vulcano  
Plaque en verre vulcano  
20 kg



Set: 067213098



Set: 067213099

22267013304

22267013305

56067013000

BEACH CHAIR \*  
Sonnenliege  
Tumbona  
Lettino  
Chaise longue  
28,5 kg 0,44 m³



067019098



067019099

CUSHION  
Kissen  
Cojín  
Cuscino  
Coussin  
75 x 195 cm



067019

95067019

56067019000

Tabletops HPL

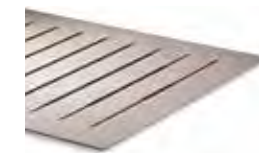

304 lipari



305 vulcano

Tabletops Glass



304 lipari glass

Bottom: lacquered in lipari



305 vulcano glass

Bottom: lacquered in vulcano

\* EN This item is also available with hook-catching mechanism upon request.

DE Dieser Artikel ist auf Anfrage auch mit Stufenverstellung erhältlich.

ES Bajo pedido este artículo también está disponible con un mecanismo de ajuste escalonado.

IT Questo articolo è disponibile su richiesta anche con meccanismo di regolazione reclinabile.

FR Cet article est disponible, sur demande, avec un mécanisme de réglage du niveau d'inclinaison.



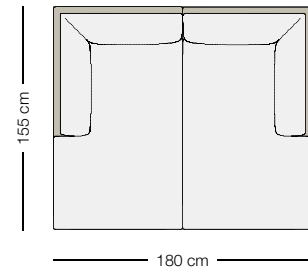

**MU Setting 01**

- 1x **067018** – Daybed right, Seat cushion + Back cushion
- 1x **067017** – Daybed left, Seat cushion + Back cushion

Recommended deco cushions:  
 2x **95050081** – 40 x 40 cm

For inspiration please see page 67

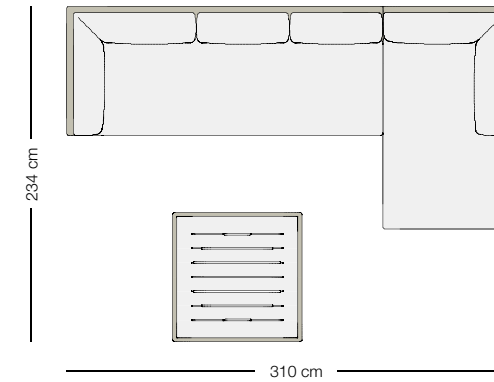

**MU Setting 04**

- 1x **067004** – Right module XXL, Seat cushion + Back cushions
- 1x **067017** – Daybed left, Seat cushion + Back cushion
- 1x **067116** – Coffee table 90 x 90 cm, HPL top

Recommended deco cushions:  
 2x **95050081** – 40 x 40 cm  
 1x **95050082** – 50 x 50 cm

For inspiration please see page 200

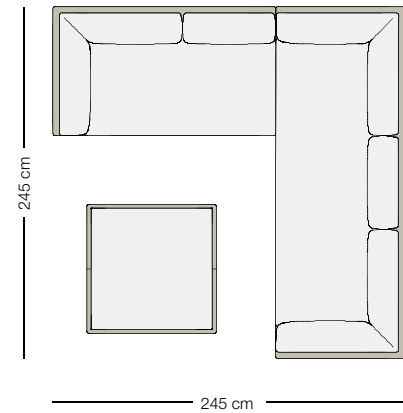

**MU Setting 02**

- 1x **067003** – Right module, Seat cushion + Back cushions
- 1x **067015** – 4-seater, Seat cushion + Back cushions
- 1x **067216** – Coffee table 90 x 90 cm, Glass top

Recommended deco cushions:  
 2x **95050081** – 40 x 40 cm  
 1x **95050082** – 50 x 50 cm

For inspiration please see pages 64–65

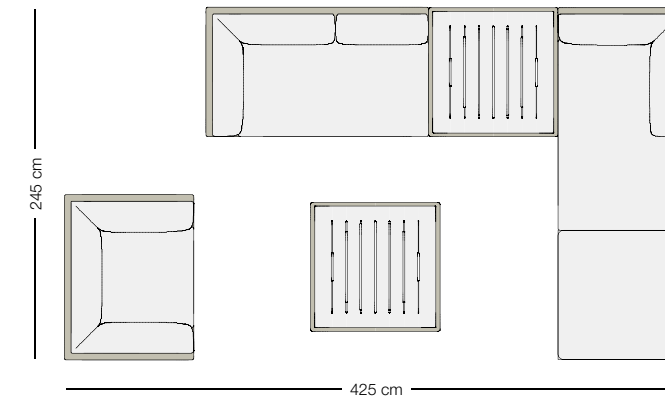

**MU Setting 05**

- 1x **067001** – Lounge chair, Seat cushion + Back cushion
- 1x **067003** – Right module, Seat cushion + Back cushions
- 1x **067017** – Daybed left, Seat cushion + Back cushion
- 1x **067016** – Footstool, Seat cushion
- 2x **067116** – Coffee table 90 x 90 cm, HPL top

Recommended deco cushions:  
 2x **95050081** – 40 x 40 cm  
 1x **95050082** – 50 x 50 cm

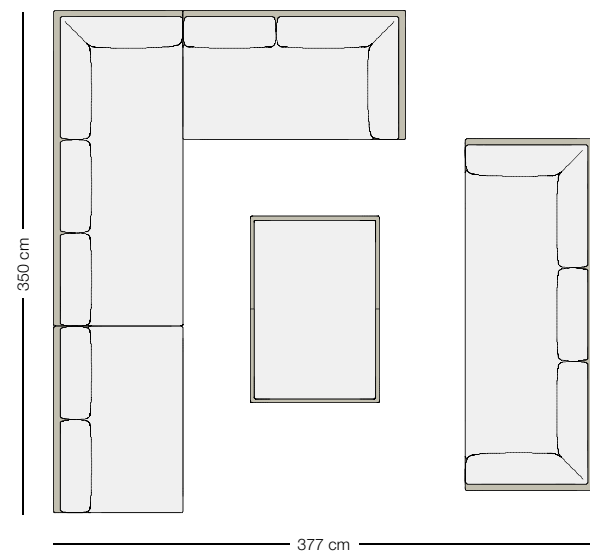

**MU Setting 03**

- 1x **067011** – Center module, Seat cushion + Back cushions
- 1x **067006** – Left module XXL, Seat cushion + Back cushions
- 1x **067005** – Left module, Seat cushion + Back cushions
- 1x **067015** – 4-seater, Seat cushion + Back cushions
- 1x **067213** – Coffee table 90 x 130 cm, Glass top

Recommended deco cushions:  
 6x **95050081** – 40 x 40 cm  
 4x **95050082** – 50 x 50 cm

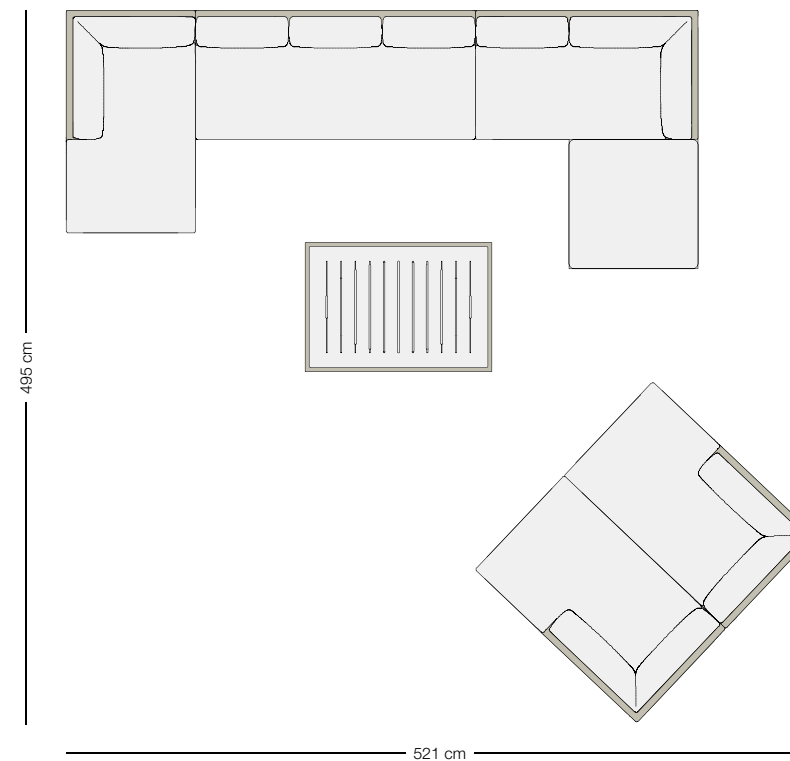

**MU Setting 06**

- 1x **067012** – Center module XXL, Seat cushion + Back cushions
- 1x **067005** – Left module, Seat cushion + Back cushions
- 1x **067016** – Footstool, Seat cushion
- 1x **067113** – Coffee table 90 x 130 cm, HPL top
- 2x **067018** – Daybed right, Seat cushion + Back cushion
- 1x **067017** – Daybed left, Seat cushion + Back cushion

Recommended deco cushions:  
 6x **95050081** – 40 x 40 cm  
 4x **95050082** – 50 x 50 cm



# NESTREST

Design by DANIEL POUZET & FRED FRETY



Standing lounger  
Hanging lounger  
Cushion: COOL white 450

## Recommended combinations

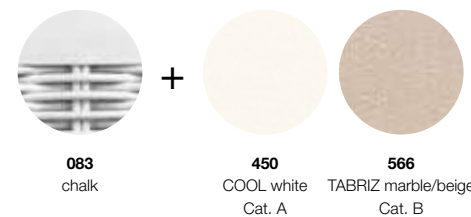
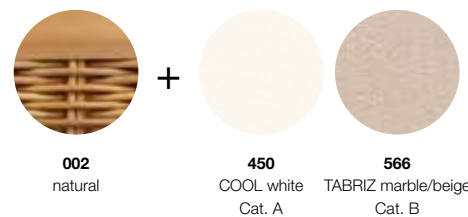

HANGING LOUNGER \*  
Hanging lounger  
Hanging lounger  
Hanging lounger  
Hanging lounger  
Hanging lounger  
ø 200 cm  
85,5 kg 10,7 m³



090019002

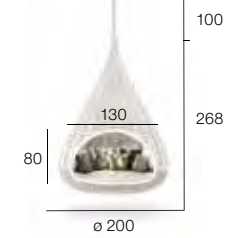

090019083

FOLDABLE SEAT CUSHION  
Faltbares Sitzkissen  
Cojín de asiento plegable  
Cuscino seduta  
Coussin de siège pliable  
ø 188 x 13,5 cm



95090219

6600000863

STANDING LOUNGER, INCL. BASE \*  
Standing lounger, inkl. Untersatz  
Standing lounger, base incl.  
Standing lounger, base incl.  
Standing lounger, avec socle  
ø 200 cm  
99,5 kg 11,8 m³



090023002

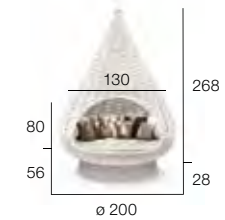

090023083

FOLDABLE SEAT CUSHION  
Faltbares Sitzkissen  
Cojín de asiento plegable  
Cuscino seduta  
Coussin de siège pliable  
ø 188 x 13,5 cm



95090219

6600000863

BASE, SUITABLE FOR HANGING AND STANDING LOUNGER  
Untersatz, passend für Hanging und Standing lounger  
Base, adaptable para el hanging y standing lounger  
Base, adatta per Hanging e Standing lounger  
Socle, convient pour Hanging lounger et Standing lounger  
14 kg 0,34 m³



090018002



090018083

RECOMMENDED NUMBER OF DECO CUSHIONS  
Empfohlene Dekokissenmenge  
Número de cojines decoración recomendados  
Numero di cuscini decorativi  
Nombre de coussins déco recommandé

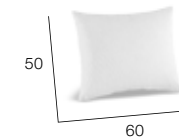

8x 95050087

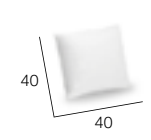

4x 95050081

**EN** Hanging and standing lounger do not fit through standard doors! **DE** Hanging und Standing Lounger passen nicht durch Türen mit Standardabmessungen! **ES** Debido a las dimensiones de este producto se recomienda verifiquen la accesibilidad! **IT** Hanging e Standing lounger non passano attraverso le normali porte! **FR** Ni le Hanging lounger ni le Standing lounger ne passent par des portes standard!

\* **EN** Weight capacity 350 kg **DE** Tragkraft 350 kg **ES** Capacidad de carga 350 kg **IT** Portata 350 kg **FR** Capacité de charge 350 kg

\*\* **EN** Cover is tailored to protect seat and deco cushions only. **DE** Die Husse dient nur zum Schutz der Sitzfläche und der Dekokissen. **ES** La funda está confeccionada para proteger el asiento y los cojines decorativos únicamente. **IT** La housse è confezionata in modo da proteggere esclusivamente la seduta e i cuscini decorativi. **FR** La housse est uniquement destinée à protéger le siège et les coussins décos.

**EN** The NESTREST is shipped with pre-mounted handles. **DE** Das NESTREST wird inkl. vormontierter Griffe geliefert. **ES** El NESTREST se entrega con asas de transporte desmontables. **IT** NESTREST viene fornito con impugnatura premontata. **FR** Le NESTREST est fourni avec des poignées de transport pré-montées.



**EN** NESTREST foldable cushion comes with handles for easy carriage. **DE** Das faltbare Sitzkissen von NESTREST wird mit zwei Schlaufen geliefert, um den Transport zu erleichtern. **ES** El cojín plegable de NESTREST viene provisto de asas para facilitar su transporte. **IT** Il cuscino ripiegabile di NESTREST è dotato di maniglie per un facile trasporto. **FR** Pour faciliter le transport, un coussin pliable du NESTREST est livré avec deux poignées.

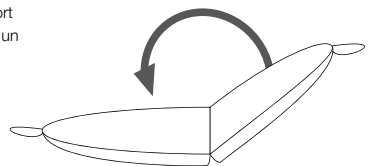



# ORBIT & ORBIT XXL

Design by RICHARD FRINIER



Loveseat XXL  
Cushion: CURL taupe 613

## Recommended combinations ORBIT & ORBIT XXL

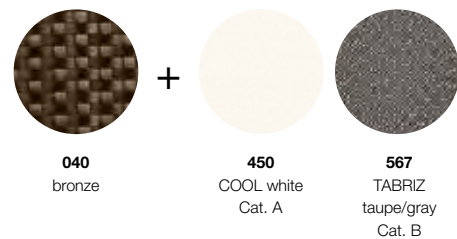

## Recommended combinations ORBIT

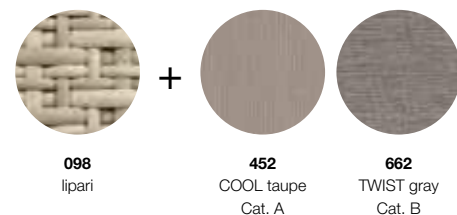

### LOVESEAT INCL. CANOPY (WHITE)

Sofainsele inkl. Verdeck (white)  
Sofá isla incl. capota (white)  
Isola 2 posti, Capote (white) incl.  
L'îlot câlin, Cabriolet (white) incl.  
ø 165 cm  
42,5 kg 2,6 m³



030005040



030005083

SEAT CUSHION  
Sitzkissen  
Cojín de asiento  
Cuscino seduta  
Coussin d'assise  
ø 127 cm



95030001

56030003000

### LOVESEAT INCL. CANOPY (WHITE)

Sofainsele inkl. Verdeck (white)  
Sofá isla incl. capota (white)  
Isola 2 posti, Capote (white) incl.  
L'îlot câlin, Cabriolet (white) incl.  
ø 165 cm  
32 kg 2,6 m³



030008099



030008098

SEAT CUSHION  
Sitzkissen  
Cojín de asiento  
Cuscino seduta  
Coussin d'assise  
ø 127 cm



95030001

56030003000

### RECOMMENDED NUMBER OF DECO CUSHIONS

Empfohlene Dekokissenmenge  
Número de cojines decoración recomendados  
Numero di cuscini decorativi  
Nombre de coussins déco recommandé

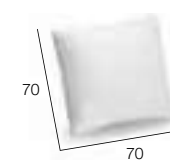

2x 95050086

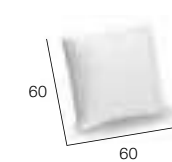

2x 95050084

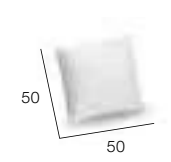

2x 95050082

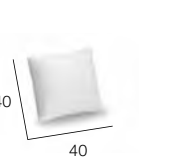

2x 95050081

### LOVESEAT XXL INCL. CANOPY (TAUPE)

Sofainsele XXL inkl. Verdeck (taupe)  
Sofá isla XXL incl. capota (taupe)  
Isola 2 posti XXL, Capote (taupe) incl.  
L'îlot câlin XXL, Cabriolet (taupe) incl.  
ø 220 cm  
69 kg 4,84 m³



030006083

SEAT CUSHION  
Sitzkissen  
Cojín de asiento  
Cuscino seduta  
Coussin d'assise  
ø 184 cm



95030004

56030006000

### LOVESEAT XXL INCL. CANOPY (WHITE)

Sofainsele XXL inkl. Verdeck (white)  
Sofá isla XXL incl. capota (white)  
Isola 2 posti XXL, Capote (white) incl.  
L'îlot câlin XXL, Cabriolet (white) incl.  
ø 220 cm  
69 kg 4,84 m³



030006040



030911083

SEAT CUSHION  
Sitzkissen  
Cojín de asiento  
Cuscino seduta  
Coussin d'assise  
ø 184 cm



95030004

56030006000

### RECOMMENDED NUMBER OF DECO CUSHIONS

Empfohlene Dekokissenmenge  
Número de cojines decoración recomendados  
Numero di cuscini decorativi  
Nombre de coussins déco recommandé

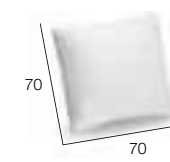

4x 95050086

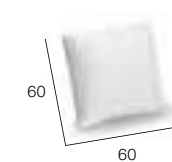

4x 95050084

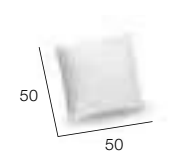

2x 95050082

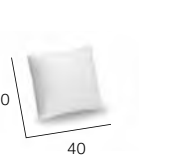

2x 95050081

**EN** The loveseat / loveseat XXL is shipped with pre-mounted pullout casters. **DE** Die Sofainsele / Sofainsele XXL wird inkl. vormontierter ausklappbarer Räder geliefert. **ES** El sofá isla / El sofá isla XXL se entrega con ruedas premontadas plegables. **IT** L'isola / L'isola XXL viene fornita completa di ruote pieghevoli. **FR** L'îlot câlin / L'îlot câlin XXL sont fournis avec des roues pré-montées escamotables.

**EN** ORBIT with lipari or vulcano fiber comes with a seat consisting of sling material. ORBIT and ORBIT XXL woven in bronze or chalk fiber come with a DEDON Fiber surface underneath the seat cushion. **DE** Bei ORBIT in lipari und vulcano Faser besteht die Sitzfläche unter dem Sitzkissen aus Sling Material. Bei ORBIT und ORBIT XXL in bronze und chalk Faser besteht diese aus DEDON Faser. **ES** Los asientos de ORBIT de fibra lipari o vulcano están compuestos de material de tensor. ORBIT y ORBIT XXL, tejidos con fibra bronze y chalk, cuentan con una superficie elaborada con fibra DEDON debajo de los cojines de los asientos. **IT** ORBIT con fibra lipari o vulcano è disponibile con seduta in fettuccia in poliestere. ORBIT e ORBIT XXL intrecciati in fibra bronze o chalk sono offerti con una superficie in Fibra DEDON sotto il cuscino della seduta. **FR** La surface d'assise des meubles ORBIT en fibre lipari ou vulcano est fabriquée en matériel sling. Pour ORBIT et ORBIT XXL tressés en fibre de bronze ou calcaire, la surface sous le coussin d'assise est en fibre DEDON.







Armchair  
Side chair  
Cushion: TWIST gray 662

### Recommended combinations



ARMCHAIR  
Armlehnstuhl  
Silla con brazos  
Poltrona pranzo  
Fauteuil repas  
7 kg 0,35 m<sup>3</sup>

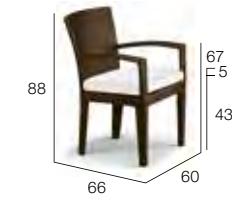

022001040

SEAT CUSHION  
Sitzkissen  
Cojín de asiento  
Cuscino seduta  
Coussin d'assise  
58 x 48 cm



022001

SIDE CHAIR  
Esstuhl  
Silla de comedor  
Sedia pranzo  
Chaise repas  
5 kg 0,25 m<sup>3</sup>

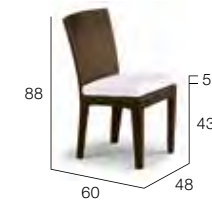

022003040

SEAT CUSHION  
Sitzkissen  
Cojín de asiento  
Cuscino seduta  
Coussin d'assise  
46 x 44 cm



022003

DINING TABLE  
Esstisch  
Mesa comedor  
Tavolo pranzo  
Table repas  
100 x 100 cm  
9,5 kg 0,75 m<sup>3</sup>

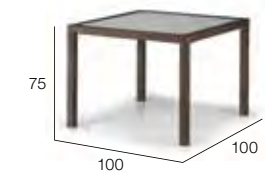

Set: 222270040

SATINATED GLASS TOP  
Satinierter Glasplatte  
Sobre de cristal satinado  
Piano in vetro satinato  
Plaque en verre satinée  
15,5 kg

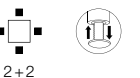

122270040

DINING TABLE  
Esstisch  
Mesa comedor  
Tavolo pranzo  
Table repas  
100 x 200 cm  
11 kg 1,5 m<sup>3</sup>

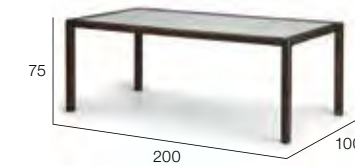

Set: 222120040

SATINATED GLASS TOP  
Satinierter Glasplatte  
Sobre de cristal satinado  
Piano in vetro satinato  
Plaque en verre satinée  
33 kg

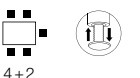

122120040

BARSTOOL  
Barhocker  
Taburete de bar  
Sgabello bar  
Tabouret de bar  
6 kg 0,28 m<sup>3</sup>



022029040

SEAT CUSHION  
Sitzkissen  
Cojín de asiento  
Cuscino seduta  
Coussin d'assise  
41 x 40 cm



022029

### Tabletops Glass



000 satinated glass  
Bottom: satinated  
PANAMA Dining table



000 clear glass  
PANAMA Side table



LOUNGE CHAIR  
Sessel  
Sillón bajo  
Poltrona club  
Fauteuil club  
8 kg 0,53 m³

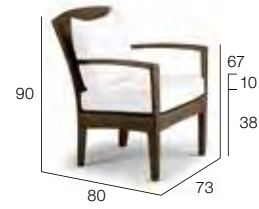

022005040

SEAT CUSHION + BACK CUSHION  
Sitzkissen + Rückenkissen  
Cojín de asiento + Cojín de respaldo  
Cuscino seduta + Cuscino schienale  
Coussin d'assise + Coussin de dossier  
67 x 58 cm + 50 x 60 cm



95022005 56022005000

SIDE TABLE  
Beistelltisch  
Mesa auxiliar  
Tavolino d'appoggio  
Table d'appoint  
46 x 46 cm  
4 kg 0,1 m³

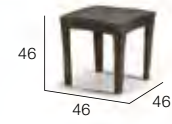

Set: 022034040

CLEAR GLASS TOP  
Klarglasplatte  
Sobre de cristal transparente  
Piano in vetro trasparente  
Plaque en verre clair  
3 kg



22222033000 56022033000

BEACH CHAIR  
Sonnenliege  
Tumbona  
Lettino  
Chaise longue  
16 kg 1,05 m³



022020040

CUSHION  
Kissen  
Cojín  
Cuscino  
Coussin  
61 x 196 cm



022020 95022019 56022019000



PANAMA Armchair  
Cushion: TWIST gray 662





Side chair carbon & chalk  
Side chair stone & chalk

Material

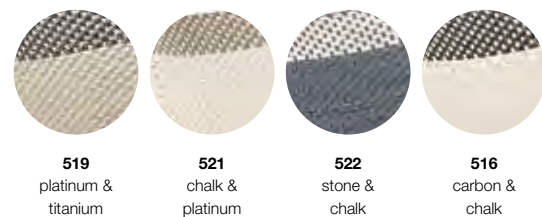

**519** platinum & titanium  
**521** chalk & platinum  
**522** stone & chalk  
**516** carbon & chalk

SIDE CHAIR  
Esstuhl  
Silla de comedor  
Sedia pranzo  
Chaise repas  
4,2 kg 0,2 m³

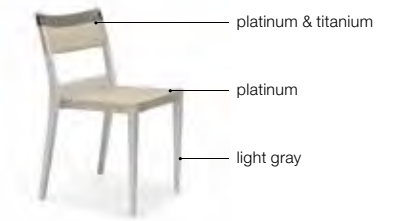

402003519

56400003000

ARMCHAIR  
Armlehnstuhl  
Silla con brazos  
Poltrona pranzo  
Fauteuil repas  
4,8 kg 0,24 m³

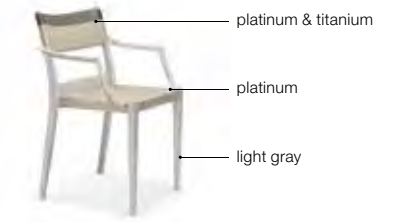

402101519

56400001000

SIDE CHAIR  
Esstuhl  
Silla de comedor  
Sedia pranzo  
Chaise repas  
4,2 kg 0,2 m³

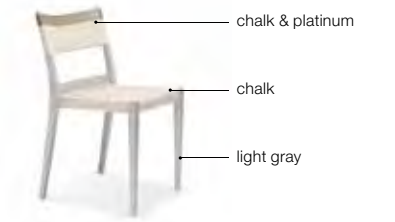

402003521

56400003000

ARMCHAIR  
Armlehnstuhl  
Silla con brazos  
Poltrona pranzo  
Fauteuil repas  
4,8 kg 0,24 m³

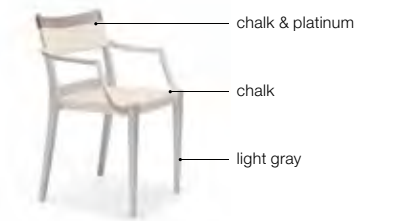
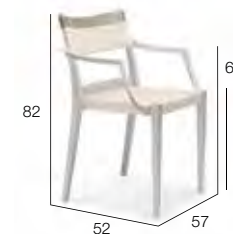

402101521

56400001000

SIDE CHAIR  
Esstuhl  
Silla de comedor  
Sedia pranzo  
Chaise repas  
4,2 kg 0,2 m³



403003522

56400003000

ARMCHAIR  
Armlehnstuhl  
Silla con brazos  
Poltrona pranzo  
Fauteuil repas  
4,8 kg 0,24 m³



403101522

56400001000



SIDE CHAIR  
 Esstuhl  
 Silla de comedor  
 Sedia pranzo  
 Chaise repas  
 4,2 kg 0,2 m³

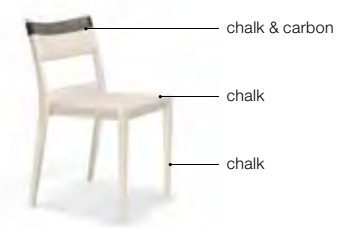

403003516

56400003000

ARMCHAIR  
 Armlehnstuhl  
 Silla con brazos  
 Poltrona pranzo  
 Fauteuil repas  
 4,8 kg 0,24 m³

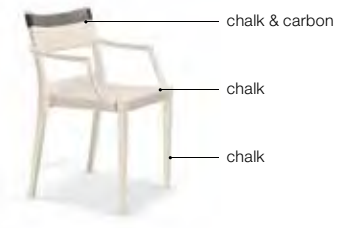
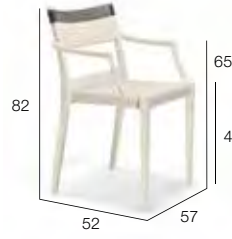

403101516

56400001000

**EN** The frames and armrests of the PLAY armchairs and side chairs consist of injection-molded polypropylene, the perfect material for all weather conditions. The seat and back are woven with DEDON fiber. Clean with a soft cloth and warm water.

**DE** Die Rahmen und Armlehnen der PLAY Stühle werden im Spritzgussverfahren aus Polypropylen hergestellt, einem perfekten Material für alle Wetterlagen. Der Sitz und die Rückenlehne sind mit DEDON Faser beflochten. Einfach mit einem weichen Tuch und warmem Wasser zu reinigen.

**ES** El armazón y los reposabrazos de las butacas y sillas PLAY están hechos de polipropileno moldeado por inyección, que es el material perfecto para todo tipo de condiciones climatológicas. El asiento y el respaldo están trenzados con fibra DEDON. Limpielas con agua tibia y un paño suave.

**IT** I telai e i braccioli delle sedie PLAY, con e senza braccioli, sono in polipropilene stampato a iniezione, il materiale perfetto per resistere a tutti gli agenti atmosferici. La seduta e lo schienale possono essere in fibra DEDON. Pulire con un panno morbido e acqua tiepida.

**FR** Les châssis et les accoudoirs des chaises et des fauteuils PLAY sont en polypropylène moulé par injection, une matière idéale pour toutes les conditions climatiques. Le siège et le dossier sont tressés avec la fibre DEDON. Nettoyer avec un chiffon doux imbibé d'eau chaude.







Side table woven base ø 61 cm  
 Side table woven base ø 41 cm  
 Side table ceramic base ø 51 cm  
 Coffee table woven base ø 100 cm  
 Side table woven base ø 51 cm

Woven

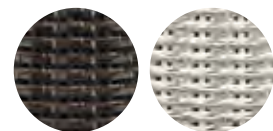

116  
marrone

117  
carrara

Ceramic



301  
black

308  
taupe

SIDE TABLE  
 Beistelltisch  
 Mesa auxiliar  
 Tavolino d'appoggio  
 Table d'appoint  
**ø 61 cm**  
 12,5 kg 0,11 m³



087034116



087034117

087034



56087034000



087034301



087034308

22 kg 0,11 m³

SIDE TABLE  
 Beistelltisch  
 Mesa auxiliar  
 Tavolino d'appoggio  
 Table d'appoint  
**ø 51 cm**  
 9 kg 0,11 m³



087036116



087036117

087036



56087036000



087036301



087036308

16 kg 0,11 m³

SIDE TABLE  
 Beistelltisch  
 Mesa auxiliar  
 Tavolino d'appoggio  
 Table d'appoint  
**ø 41 cm**  
 8 kg 0,09 m³



087038116



087038117

087038



56087038000

COFFEE TABLE  
 Kaffeetisch  
 Mesa de centro  
 Tavolino da salotto  
 Table de salon  
**ø 100 cm**  
 26,9 kg 0,26 m³



087032116



087032117

087032



56087032000

**EN** The tabletop is made of Monolite Ipergres®, a frost-proof ceramic material that is non-absorbing and highly resistant to indirect tensile stress, impacts, scratches and abrasion. Available in a choice of marrone or carrara, the woven base consists of a mix of DEDON fiber and marine rope, interlaced through a powder-coated aluminum structure. Covers are suitable only for PORCINI with woven bases. The warranty for PORCINI is limited to two years.

**DE** Die Tischplatten werden aus Monolite Ipergres® gefertigt, einem frostsicheren, wasserabweisenden Keramikmaterial mit ausgezeichneter Kratz- und Abriebfestigkeit. Die Untergestelle der Farben marrone und carrara bestehen aus einem Mix aus DEDON Faser und Seilen, eingeflochten in ein pulverbeschichtetes Alugeflecht. Die Hussen können nur für PORCINI Beistelltische mit gewebtem Unterteil verwendet werden. Für PORCINI-Möbel gilt eine Garantie von 2 Jahren.

**ES** El tablero Monolite Ipergres® es un material de cerámica resistente a las heladas y repelente al agua, con una excelente resistencia al peso, los golpes, los arañazos y la abrasión. Disponible en Marrone o Carrara, la base está trenzada con una combinación de fibra DEDON y cuerdas marinas que se entrelazan en una estructura de aluminio con acabado en pintura de polvo. Las fundas son adecuadas únicamente para PORCINI con una base tejida. La garantía de PORCINI se limita a 2 años.

**IT** Il piano del tavolo è in Monolite Ipergres®, un materiale ceramico antigelo, idrorepellente, caratterizzato da un'eccellente resistenza alle sollecitazioni indirette, agli urti, ai graffi e all'abrasione. Disponibile nelle versioni Marrone e Carrara, la base si compone di un intreccio di fibra DEDON e da corde marine inserito in una struttura di alluminio verniciato a polvere. I teli di copertura sono adatti solo agli arredi PORCINI con base intrecciata. La garanzia di PORCINI è limitata a 2 anni.

**FR** Le plateau de table est en Monolite Ipergres®, un matériau céramique résistant au gel, qui n'absorbe pas et qui est hautement résistant aux contraintes de traction indirectes, aux rayures et à l'abrasion. Disponible en Marrone ou Carrara, la base tressée est un mélange de fibre DEDON et de corde de bateau, entrelacées à travers une structure en aluminium thermolaqué. Les nappes ne sont adaptées qu'aux tables PORCINI à la base tressée. Les tables PORCINI sont garanties 2 ans.





Right module, incl. right armrest  
Left module  
Coffee table 176 x 88 cm  
Cushion: LINEN warm gray 652

Recommended combinations

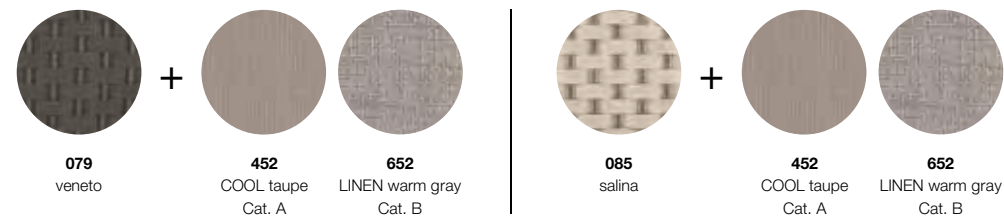

CORNER MODULE

Eckmodul  
Módulo esquina  
Modulo d'angolo  
Module d'angle  
19 kg 0,61 m<sup>3</sup>



078006

078006085

SEAT CUSHION + BACK CUSHIONS (RIGHT)  
Sitzkissen + Rückenkissen (rechts)  
Cojín de asiento + Cojines de respaldo (derecho)  
Cuscino seduta + Cuscini schienale (destra)  
Coussin d'assise + Coussins de dossier (droit)  
65 x 65 cm + 168 x 55 cm

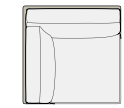

95078016

56078006000



078006079

SEAT CUSHION + BACK CUSHIONS (LEFT)  
Sitzkissen + Rückenkissen (links)  
Cojín de asiento + Cojines de respaldo (izquierdo)  
Cuscino seduta + Cuscini schienale (sinistra)  
Coussin d'assise + Coussins de dossier (gauche)  
65 x 65 cm + 168 x 55 cm



95078006

CENTER MODULE

Modul mitte  
Módulo centro  
Modulo centrale  
Module central  
17 kg 0,83 m<sup>3</sup>



078007

078007085

SEAT CUSHION + BACK CUSHIONS  
Sitzkissen + Rückenkissen  
Cojín de asiento + Cojines de respaldo  
Cuscino seduta + Cuscini schienale  
Coussin d'assise + Coussins de dossier  
127 x 65 cm + 126 x 55 cm



95078007

56078007000



078007079

LEFT MODULE, INCL. LEFT ARMREST

Modul links, Armlehne links  
Módulo izquierdo, brazo izquierdo  
Modulo sinistro, bracciolo sinistro  
Module gauche, accoudoir gauche incl.  
30 kg 1,04 m<sup>3</sup>



078008

078008085

SEAT CUSHION + BACK CUSHIONS + SIDE CUSHION  
Sitzkissen + Rückenkissen + Seitenkissen  
Cojín de asiento + Cojines de respaldo + Cojín lateral  
Cuscino seduta + Cuscini schienale + Cuscino laterale  
Coussin d'assise + Coussins de dossier + Coussin latéral  
127 x 65 cm + 144 x 55 cm + 50 x 40 cm



95078008

56078008000



078008079

RECOMMENDED DECO CUSHIONS

Empfohlene Dekokissen  
Cojines decoración recomendados  
Cuscini decorativi consigliati  
Coussins déco recommandés

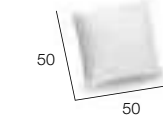

95050082



95050081



RIGHT MODULE, INCL. RIGHT ARMREST

Modul rechts, Armlehne rechts  
 Módulo derecho, incl. brazo derecho  
 Modulo destro, bracciolo destro  
 Module droit, accoudoir droit incl.  
 30 kg 1,04 m<sup>3</sup>



078009085

078009

SEAT CUSHION + BACK CUSHIONS + SIDE CUSHION  
 Sitzkissen + Rückenkissen + Seitenkissen  
 Cojín de asiento + Cojines de respaldo + Cojín lateral  
 Cuscino seduta + Cuscini schienale + Cuscino laterale  
 Coussin d'assise + Coussins de dossier + Coussin latéral  
 127 x 65 cm + 144 x 55 cm + 50 x 40 cm



95078009

56078009000



078009079

3-SEATER, INCL. LEFT + RIGHT ARMREST

3er-Sofa, Armlehne links + rechts  
 Sofá 3 plazas, incl. brazos izquierdo y derecho  
 Divano 3 posti, bracciolo sinistro e destro  
 Canapé 3 places, accoudoir gauche et droit incl.  
 49 kg 1,8 m<sup>3</sup>



078013085

078013

SEAT CUSHION + BACK CUSHIONS + 2x SIDE CUSHIONS  
 Sitzkissen + Rückenkissen + 2x Seitenkissen  
 Cojín de asiento + Cojines de respaldo + 2x Cojines lateral  
 Cuscino seduta + Cuscini schienale + 2x Cuscini laterale  
 Coussin d'assise + Coussins de dossier + 2x Coussins latéral  
 208 x 65 cm + 241 x 55 cm + 2x 50 x 40 cm



95078013

56078013000



078013079

LEFT MODULE

Modul links  
 Módulo izquierdo  
 Modulo sinistro  
 Module gauche  
 22 kg 1,02 m<sup>3</sup>



078005085

078005

SEAT CUSHION + BACK CUSHIONS  
 Sitzkissen + Rückenkissen  
 Cojín de asiento + Cojines de respaldo  
 Cuscino seduta + Cuscini schienale  
 Coussin d'assise + Coussins de dossier  
 130 x 65 cm + 231 x 55 cm



95078005

56078005000



078005079

DAYBED, INCL. LEFT ARMREST

Daybed, Armlehne links  
 Daybed, brazo izquierdo  
 Daybed, bracciolo sinistro  
 Daybed, accoudoir gauche incl.  
 32 kg 1,23 m<sup>3</sup>



078018085

078018

SEAT CUSHION + BACK CUSHION + SIDE CUSHION  
 Sitzkissen + Rückenkissen + Seitenkissen  
 Cojín de asiento + Cojín de respaldo + Cojín lateral  
 Cuscino seduta + Cuscino schienale + Cuscino laterale  
 Coussin d'assise + Coussin de dossier + Coussin latéral  
 132 x 76 cm + 92 x 55 cm + 50 x 40 cm



95078018

56078018000



078018079

RIGHT MODULE

Modul rechts  
 Módulo derecho  
 Modulo destro  
 Module droit  
 22 kg 1,02 m<sup>3</sup>



078003085

078003

SEAT CUSHION + BACK CUSHIONS  
 Sitzkissen + Rückenkissen  
 Cojín de asiento + Cojines de respaldo  
 Cuscino seduta + Cuscini schienale  
 Coussin d'assise + Coussins de dossier  
 130 x 65 cm + 231 x 55 cm

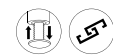

95078003

56078003000



078003079

DAYBED, INCL. RIGHT ARMREST

Daybed, Armlehne rechts  
 Daybed, incl. brazo derecho  
 Daybed, bracciolo destro  
 Daybed, accoudoir droit incl.  
 32 kg 1,23 m<sup>3</sup>



078017085

078017

SEAT CUSHION + BACK CUSHION + SIDE CUSHION  
 Sitzkissen + Rückenkissen + Seitenkissen  
 Cojín de asiento + Cojín de respaldo + Cojín lateral  
 Cuscino seduta + Cuscino schienale + Cuscino laterale  
 Coussin d'assise + Coussin de dossier + Coussin latéral  
 132 x 76 cm + 92 x 55 cm + 50 x 40 cm



95078017

56078017000



078017079



BEACH CHAIR \*  
Sonnenliege  
Tumbona  
Lettino  
Chaise longue  
15 kg 0,37 m<sup>3</sup>

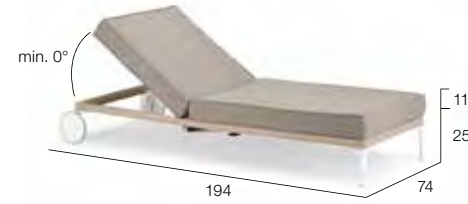

078019085

CUSHION  
Kissen  
Cojín  
Cuscino  
Coussin  
75 x 187 cm



95078019 56078019000

078019



078019079

FOOTSTOOL  
Hocker  
Reposapiés  
Pouf  
Repose-pieds  
11 kg 0,2 m<sup>3</sup>



078031085



078031079

SEAT CUSHION  
Sitzkissen  
Cojín de asiento  
Cuscino seduta  
Coussin d'assise  
88 x 88 cm



95078031 56078031000

078031

COFFEE TABLE  
Kaffeetisch  
Mesa de centro  
Tavolino da salotto  
Table de salon  
88 x 88 cm  
4 kg 0,2 m<sup>3</sup>



MINERAL-COMPOSITE BASALIT  
Mineralverbund basalt  
Compuesto mineral basalt  
Composito minerale basalt  
Composite minéral basalt  
22,5 kg



MINERAL-COMPOSITE MOCCA  
Mineralverbund mocca  
Compuesto mineral mocca  
Composito minerale mocca  
Composite minéral mocca  
22,5 kg



078035

Set: 078036315

23378035315

Set: 078036316

23378035316

56078036000

COFFEE TABLE  
Kaffeetisch  
Mesa de centro  
Tavolino da salotto  
Table de salon  
176 x 88 cm  
8 kg 0,39 m<sup>3</sup>



2x MINERAL-COMPOSITE BASALIT  
2x Mineralverbund basalt  
2x Compuesto mineral basalt  
2x Composito minerale basalt  
2x Composite minéral basalt  
2x 22,5 kg (Total 45 kg)



2x MINERAL-COMPOSITE MOCCA  
2x Mineralverbund mocca  
2x Compuesto mineral mocca  
2x Composito minerale mocca  
2x Composite minéral mocca  
2x 22,5 kg (Total 45 kg)



078037

Set: 078038315

2x 23378035315

Set: 078038316

2x 23378035316

56078038000

### Tabletop Mineral-Composite



315 basalt



316 mocca

\* **EN** This item is also available with hook-catching mechanism upon request.

**DE** Dieser Artikel ist auf Anfrage auch mit Stufenverstellung erhältlich.

**ES** Bajo pedido este artículo también está disponible con un mecanismo de ajuste escalonado.

**IT** Questo articolo è disponibile su richiesta anche con meccanismo di regolazione reclinabile.

**FR** Cet article est disponible, sur demande, avec un mécanisme de réglage du niveau d'inclinaison.

TRAY  
Tablett  
Bandeja  
Vassoio  
Plateau  
78 x 29 cm  
2 kg

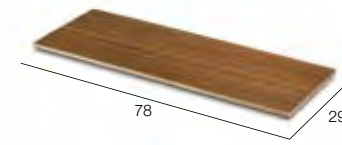

078099201

**EN** Multi-layered and of varying densities, the foam of the RAYN collection **cushions** gives them a suppleness comparable to that of down feathers and allows them quickly to recover their original shape. The comfort level of the cushions is truly extraordinary, rivaling that of luxury indoor cushions. The **coffee table** with basalt top combines nicely with RAYN furniture in salina. The coffee table with mocca top combines nicely with RAYN furniture in veneto. The RAYN **tray** features a teak finish. The entire tray is covered with an outdoor sealant to protect it from water and humidity. This material offers excellent protection against abrasion, UV rays and all weather conditions. Clean with a damp cloth. Do not apply cleaning detergent of any kind. To maintain the beautiful wood finish, the RAYN teak tray should be protected from moisture and kept indoors when not in use.

**DE** Der Schaumstoff der RAYN Kissen besteht aus mehreren Schichten unterschiedlicher Dichte. Die **Kissen** sind so weich, dass man sie durchaus mit daunenfedergefüllten Kissen vergleichen kann. Eine weitere Eigenschaft ist, dass sie schnell wieder in ihre ursprüngliche Form zurückfinden. Die Kissen sind außerordentlich gemütlich und können es ohne Weiteres mit Luxuskissen für den Innenbereich aufnehmen. Die **Kaffeetische** mit basaltfarbener Tischplatte lassen sich hervorragend mit den RAYN Modulen in salina kombinieren. Die Kaffeetische mit mocca-farbener Tischplatte lassen sich gut mit den RAYN Modulen in veneto kombinieren. Das RAYN **Tablett** besteht aus schichtverleimtem Holz sowie einer aus Teakholz gefertigten Oberfläche. Das Tablett ist durch ein Versiegelungsmittel gegen Wasser und Feuchtigkeit geschützt. Dieses Verfahren bietet exzellenten Schutz gegen Abrieb, UV-Strahlung und ist zudem äußerst wetterbeständig. Einfach mit einem weichen Tuch und warmem Wasser reinigen — ohne Anwendung weiterer Reinigungsmittel. Die Oberfläche des RAYN Tablett besteht aus einem Holzdekor und sollte vor Feuchtigkeit geschützt werden. Wir empfehlen daher die Aufbewahrung in Innenräumen.

**ES** De varias capas y densidades variables, la espuma de los **cojines** de la colección RAYN les da una flexibilidad comparable a la del plumón y les permite rápidamente recuperar su forma original. El nivel de confort de los cojines es verdaderamente extraordinario, comparable con los cojines de lujo de interior. Las **mesas de centro** con tablero de color basalt se pueden combinar perfectamente con los módulos RAYN en color salina. La mesa de centro con tablero en mocca combina perfectamente con el mobiliario RAYN de color veneto. La **bandeja** RAYN está fabricada en contrachapado de teca. La bandeja está recubierta con un material sellador especial para exteriores que la protege tanto del agua como de la humedad. Este material ofrece un excelente nivel de protección contra el roce, los rayos UV y todo tipo de condiciones climatológicas. Limpiela con un paño húmedo y no aplique ningún tipo de limpiador detergente. Para mantener el acabado de la teca, recomendamos que proteja la bandeja de la humedad y que se mantenga en el interior cuando no esté en uso.

**IT** La schiuma dei **cuscini** della collezione RAYN, multistrato e di densità variabile, offre una morbidezza paragonabile a quella della piuma d'oca e permette loro di recuperare rapidamente la forma originale. Il livello di comfort di questi cuscini è davvero straordinario, sicuramente all'altezza di quello dei cuscini da interno più lussuosi. Il **tavolino da salotto** con il piano color Basalit si combina perfettamente con i moduli RAYN Salina. Il tavolino da salotto con il piano Mocca si abbina perfettamente agli arredi RAYN Veneto. Il **vassoio** RAYN è interamente rivestito in Teak e sottoposto ad una finitura speciale per esterni con uno speciale sigillante che assicura la massima protezione da acqua e umidità. Questo materiale offre un'eccellente protezione contro le abrasioni, i raggi UV e tutti gli agenti atmosferici. Per mantenere inalterata la bellezza delle finiture in legno, il vassoio RAYN deve essere protetto dall'umidità e tenuto all'interno quando non viene utilizzato.

**FR** Multicouche et de densité variable, la mousse de la collection RAYN donne aux **coussins** une souplesse égale à celle du duvet et leur permet de retrouver leur forme initiale en très peu de temps. Les coussins présentent un niveau de confort extraordinaire, rivalisant avec celui des coussins d'intérieur de luxe. La **table de salon** avec le dessus de table Basalit est parfaitement assortie aux meubles RAYN Salina. La table de salon avec le dessus de table Mocca est parfaitement assortie aux meubles RAYN Veneto. Le plateau RAYN est en contre-plaqué de jonc à finition en teck. Le **plateau** est entièrement recouvert d'un enduit imperméable pour l'extérieur, assurant ainsi une protection contre l'eau et l'humidité. La matière offre une excellente protection contre l'abrasion, les rayons UV et toutes les conditions climatiques. Nettoyer avec un chiffon humide. Ne pas utiliser de détergent d'aucune sorte. Afin de préserver la beauté du bois du plateau RAYN, il est recommandé de le maintenir à l'abri de l'humidité et de le conserver à l'intérieur lorsqu'il n'est pas utilisé.



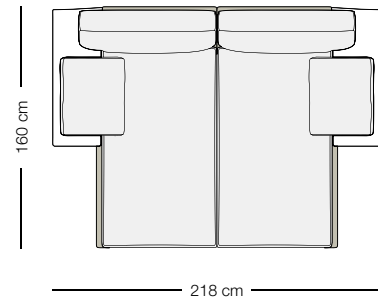

**RAYN Setting 01**

- 1x **078017** – Daybed incl. right armrest, seat cushion + back cushion + side cushion
- 1x **078018** – Daybed incl. left armrest, seat cushion + back cushion + side cushion

Recommended deco cushions:  
 2x **95050081** – 40 × 40 cm

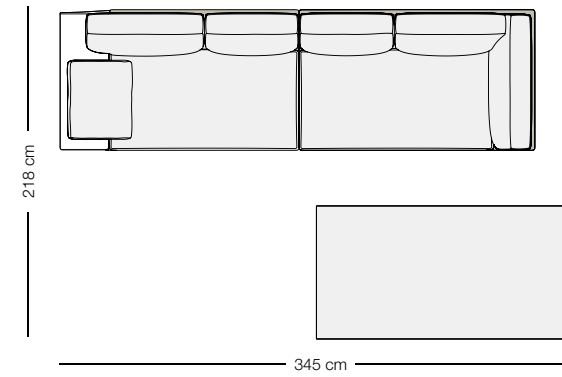

**RAYN Setting 04**

- 1x **078009** – Right module incl. right armrest, Seat cushion + Back cushions + Side cushion
- 1x **078005** – Left module, Seat cushion + Back cushions
- 1x **078038** – Coffee table 176 × 88 cm, 2x mineral compsite top

Recommended deco cushions:  
 2x **95050081** – 40 × 40 cm  
 1x **95050082** – 50 × 50 cm

For inspiration please see page 220

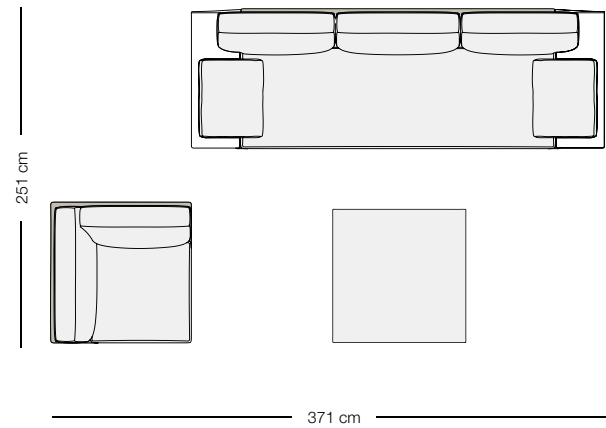

**RAYN Setting 02**

- 1x **078006** – Corner module + seat cushion + back cushions (left)
- 1x **078013** – 3-seater incl. left + right armrest, Seat cushion + Back cushions + 2x Side cushion
- 1x **078036** – Coffee table 88 × 88 cm, Mineral-composite top

Recommended deco cushions:  
 2x **95050081** – 40 × 40 cm  
 1x **95050082** – 50 × 50 cm

For inspiration please see page 93

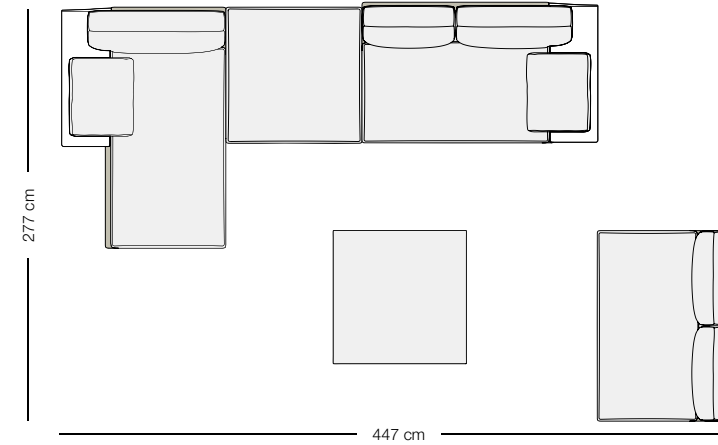

**RAYN Setting 05**

- 1x **078017** – Daybed incl. right armrest, Seat cushion + Back cushion + Side cushion
- 1x **078031** – Footstool 88 × 88 cm, Seat cushion
- 1x **078008** – Left module incl. left armrest, Seat cushion + Back cushions+ Side cushion
- 1x **078036** – Coffee table 88 × 88 cm, Mineral-composite top
- 1x **078007** – Center module, Seat cushion + Back cushions

Recommended deco cushions:  
 3x **95050081** – 40 × 40 cm  
 2x **95050082** – 50 × 50 cm

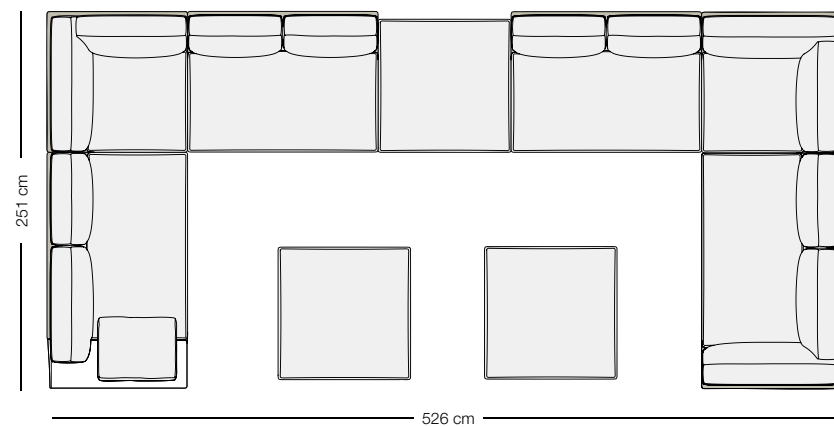

**RAYN Setting 03**

- 1x **078009** – Right module incl. right armrest, Seat cushion + Back cushions + Side cushion
- 2x **078006** – Corner module, Seat cushion + Back cushions
- 2x **078007** – Center module, Seat cushion + Back cushions
- 1x **078005** – Left module, Seat cushion + Back cushions
- 3x **078031** – Footstool 88 × 88 cm, Seat cushion

Recommended deco cushions:  
 6x **95050081** – 40 × 40 cm  
 4x **95050082** – 50 × 50 cm

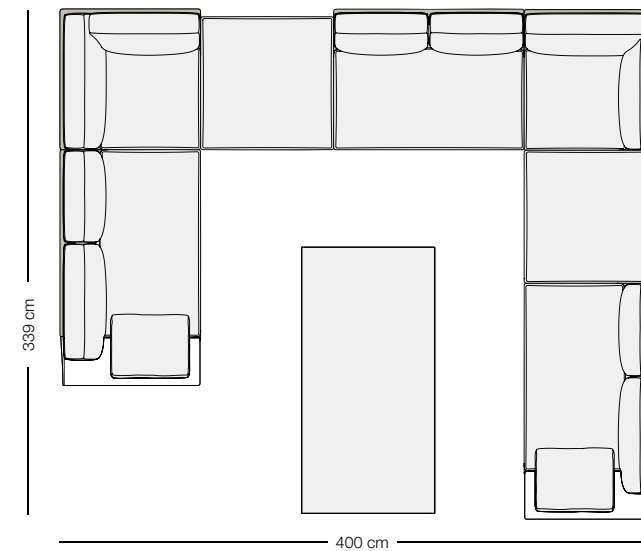

**RAYN Setting 06**

- 1x **078009** – Right module incl. right armrest, Seat cushion + Back cushions + Side cushion
- 2x **078006** – Corner module, Seat cushion + Back cushions
- 2x **078031** – Footstool 88 × 88 cm, Seat cushion
- 1x **078007** – Center module, Seat cushion + Back cushions
- 1x **078008** – Left module incl. left armrest, Seat cushion + Back cushions+ Side cushion
- 1x **078038** – Coffee table 176 × 88 cm, 2x mineral compsite top

Recommended deco cushions:  
 5x **95050081** – 40 × 40 cm  
 3x **95050082** – 50 × 50 cm





Side table ø 40 cm  
Dining table ø 70 cm

## Material

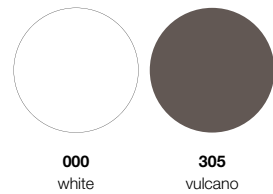

DINING TABLE  
Esstisch  
Mesa comedor  
Tavolo pranzo  
Table repas  
**ø 70 cm**  
40,5 kg 0,36 m<sup>3</sup>



050140000



73

ø 70

050140305



1 + 1



5605004000

SIDE TABLE  
Beistelltisch  
Mesa auxiliar  
Tavolino ausiliare  
Table d'appoint  
**ø 40 cm**  
5,8 kg 0,07 m<sup>3</sup>



050133000

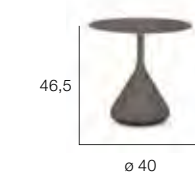

46,5

ø 40

050133305



56050033000

## Tabletops HPL



305 vulcano



000 white

**EN** Tabletop: "High Pressure Laminate" (HPL) – A non-toxic material that is highly resistant to impact, mechanical stress, moisture and steam. To clean a HPL tabletop, use a soft cloth, warm water and a gentle cleanser if needed. Base: powder-coated aluminium.

**DE** Tischplatte: „High Pressure Laminate“ (HPL) ist ein ungiftiges Material, das sich durch hohe Stoßfestigkeit und extreme Widerstandskraft gegen mechanische Einwirkungen, Feuchtigkeit und Dampf auszeichnet. Zur Reinigung der Tischplatte eignen sich ein weiches Tuch, warmes Wasser und bei Bedarf ein sanftes Reinigungsmittel. Fuß: Hergestellt aus pulverbeschichtetem Aluminium.

**ES** Tablero de mesa: HPL – El laminado de alta presión es un material no tóxico altamente resistente al impacto, estrés mecánico, humedad y vapor. Para limpiar los tableros de las mesas, utilice un paño suave y agua caliente y, si es necesario, un limpiador suave. Base: Fabricado en aluminio con revestimiento de pintura en polvo.

**IT** Piano del tavolo: HPL – Il laminato ad alta pressione (HPL) è un materiale non tossico estremamente resistente agli impatti, alle sollecitazioni meccaniche, all'umidità e al vapore. Per pulire i piani usare un panno soffice, acqua calda e, se necessario, un detergente delicato. Base: Fabricato in alluminio rivestiti in polvere.

**FR** Plateau: HPL – Le stratifié HPL (High Press Laminate) est un matériau non toxique, hautement résistant aux impacts, aux contraintes mécaniques, à l'humidité et à la vapeur d'eau. Pour nettoyer le plateau de table, utilisez un chiffon doux et de l'eau chaude et, si nécessaire, un détergent léger. Pied: Conçu en aluminium thermolaqué.



# SEASHELL

Design by JEAN-MARIE MASSAUD



Side chair  
Armchair  
Cushion: COOL white 450

## Recommended combinations

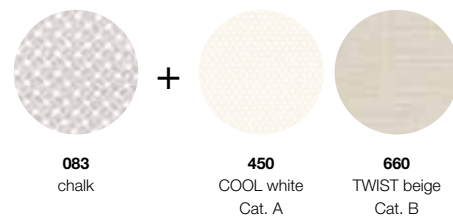
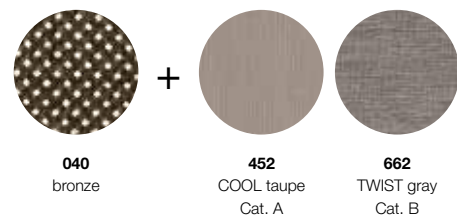

ARMCHAIR  
Armlehnstuhl  
Silla con brazos  
Poltrona pranzo  
Fauteuil repas  
4,8 kg 0,28 m<sup>3</sup>



049001040

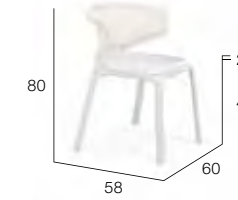

049001083

SEAT CUSHION  
Sitzkissen  
Cojín de asiento  
Cuscino seduta  
Coussin d'assise  
40 x 44 cm

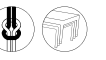

95049001

56049001000

SIDE CHAIR  
Essstuhl  
Silla de comedor  
Sedia pranzo  
Chaise repas  
4,6 kg 0,32 m<sup>3</sup>



049003040



049003083

SEAT CUSHION  
Sitzkissen  
Cojín de asiento  
Cuscino seduta  
Coussin d'assise  
40 x 44 cm



95049001

56049003000

LOUNGE CHAIR  
Sessel  
Sillón bajo  
Poltrona club  
Fauteuil club  
7,4 kg 0,55 m<sup>3</sup>



049005040



049005083

SEAT CUSHION  
Sitzkissen  
Cojín de asiento  
Cuscino seduta  
Coussin d'assise  
64 x 52 cm



95049005

56049005000

2-SEATER  
2er-Sofa  
Sofá 2 plazas  
Divano 2 posti  
Canapé 2 places  
12 kg 0,91 m<sup>3</sup>



049012040



049012083

SEAT CUSHION  
Sitzkissen  
Cojín de asiento  
Cuscino seduta  
Coussin d'assise  
132 x 55,5 cm

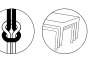

95049012

56049012000

RECOMMENDED NUMBER OF DECO CUSHIONS  
Empfohlene Dekokissenmenge  
Número de cojines decoración recomendados  
Numero di cuscini decorativi  
Nombre de coussins déco recommandé

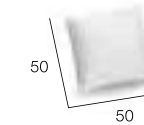

2x 95050082

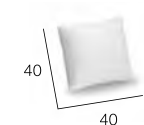

3x 95050081

FOOTSTOOL  
Hocker  
Taburete  
Pouf  
Repose-pieds  
3,8 kg 0,11 m<sup>3</sup>



049031040



049031083

SEAT CUSHION  
Sitzkissen  
Cojín de asiento  
Cuscino seduta  
Coussin d'assise  
57 x 47 cm



95049031

56049031000

SIDE TABLE  
Beistelltisch  
Mesa auxiliar  
Tavolino d'appoggio  
Table d'appoint  
47 x 47 cm  
2,5 kg 0,08 m<sup>3</sup>



049033040



049033083

SEAT CUSHION  
Sitzkissen  
Cojín de asiento  
Cuscino seduta  
Coussin d'assise  
57 x 47 cm



95049033

56049033000



BEACH CHAIR  
Sonnenliege  
Tumbona  
Lettino  
Chaise longue  
16 kg 0,67 m<sup>3</sup>



049020040



049020083

CUSHION  
Kissen  
Cojín  
Cuscino  
Coussin  
76 x 203 cm

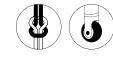

95049020

5604902000

BARSTOOL  
Barhocker  
Taburete de bar  
Sgabello bar  
Tabouret de bar  
6 kg 0,34 m<sup>3</sup>



049028040



049028083



5604902800







4x Armchair  
Dining table 100 x 280 cm

Recommended cushion combinations

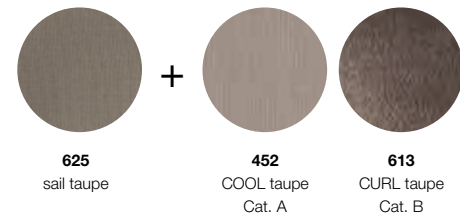
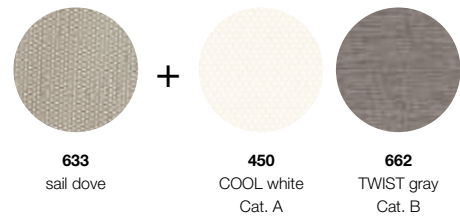
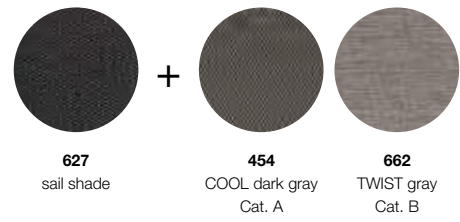

Frames

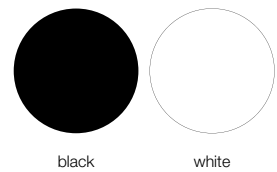

Armrests



ARMCHAIR  
Armlehnstuhl  
Silla con brazos  
Poltrona pranzo  
Fauteuil repas  
7 kg 0,26 m³



702311625



702301625



701311625

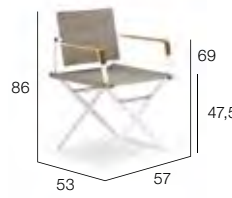

701301625

SEAT CUSHION  
Sitzkissen  
Cojín de asiento  
Cuscino seduta  
Coussin d'assise  
49 x 50 x 6 cm



95700001

56700001000



702311627



702301627



701311627



701301627



702311633



702301633



701311633



701301633

LOUNGE CHAIR  
Sessel  
Sillón bajo  
Poltrona club  
Fauteuil club  
8 kg 0,32 m³



702315625



702305625



701315625

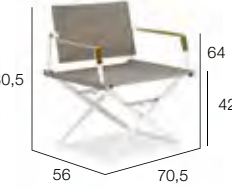

701305625

SEAT CUSHION + BACK CUSHION  
Sitzkissen + Rückenkissen  
Cojín de asiento + Cojín de respaldo  
Cuscino seduta + Cuscino schienale  
Coussin d'assise + Coussin de dossier  
63 x 57 x 6 cm + 60 x 37 cm



95700005

56700005000



702315627



702305627



701315627



701305627



702315633



702305633



701315633



701305633



FOOTSTOOL  
Hocker  
Taburete  
Pouf  
Repose-pieds  
5 kg 0,15 m<sup>3</sup>



702031625

701031625



702031627

701031627



702031633

701031633

SEAT CUSHION  
Sitzkissen  
Cojín de asiento  
Cuscino seduta  
Coussin d'assise  
63 x 57 x 6 cm



95700031

56700031000

**EN** The structure of the SEAX armchair and lounge chair is made of powder-coated die-cast aluminum. The seat and back textile is a mix of PVC, acrylic and polyester. The armrest covers are made out of teak-finished plywood. Clean the frame, seat and backrest with a soft cloth and warm water. Clean the plywood armrest covers with a damp cloth and do not apply cleaning detergents of any kind. To maintain their beautiful wood finish, the SEAX armchairs and lounge chairs with plywood armrests should be protected from moisture and kept indoors when not in use. For a low-maintenance seating alternative, choose the armchair and lounge chair without plywood armrests.

**DE** Die Rahmen von SEAX Armlehnstuhl und Sessel bestehen aus pulverbeschichtetem Aluminium. Sitzfläche und Rückenlehne bestehen aus einem Stoff, der aus PVC, Acryl und Polyester gefertigt wird. Das Holzdekor der Armlehnen besteht aus mit Teakholz beschichtetem Schichtholz. Rahmen, Sitz und Lehne mit einem weichen Tuch und warmem Wasser reinigen. Die Schichtholz-Armlehnen reinigen Sie mit einem feuchten Tuch und niemals mit Reinigungsmitteln. Schützen Sie die SEAX Armlehnstühle und Sessel vor Feuchtigkeit und bewahren Sie sie im Innenbereich auf, wenn Sie sie nicht nutzen, damit die schöne Holz-Oberfläche nicht leidet. Als pflegeleichte Alternative wählen Sie den Armlehnstuhl oder den Sessel mit Armlehnen ohne Holzoberflächen.

**ES** El armazón de SEAX esta hecho de aluminio de fundición revestido de pintura en polvo. El asiento y el respaldo constan de un tejido mezcla de PVC, acrílico y poliéster. Las fundas de los reposabrazos son de madera contrachapada con acabados en teca. Limpie el marco, el asiento y el respaldo con un paño suave y agua tibia. Limpie las fundas de contrachapado de los reposabrazos con un paño húmedo y no aplique detergentes limpiadores de ningún tipo. Para mantener su bonito acabado en madera, las sillas con brazos y sillones bajos SEAX con reposabrazos en madera contrachapada deben estar protegidos contra la humedad y mantenerse en el interior cuando no se usen. Como alternativa para un bajo mantenimiento, escoja la silla con brazos y el sillón bajo sin reposabrazos de madera contrachapada.

**IT** La struttura SEAX è realizzata in alluminio pressofuso verniciato a polvere. La seduta e lo schienale sono in tessuto composto da PVC, fibra acrilica e poliestere. Le coperture dei braccioli sono in compensato con finiture in teak. Pulire il telaio, la seduta e lo schienale con un panno morbido e acqua calda. Pulire le coperture in compensato dei braccioli con un panno umido, senza applicare detergenti di alcun tipo. Per mantenere la bellezza delle finiture in legno, le poltrone e poltrone club SEAX con braccioli in compensato devono essere protette dall'umidità e tenute all'interno, quando non vengono utilizzate. Se si desidera un'alternativa di seduta che non richieda molta manutenzione, scegliere le poltrone e le poltrone club senza braccioli in compensato.

**FR** La structure du fauteuil repas et du fauteuil club SEAX est fabriquée en aluminium coulé et laqué. Le siège et le dossier sont fabriqués dans un textile élaboré à partir de PVC, acrylique et polyester. Le revêtement des accoudoirs est en contreplaqué de teck. Nettoyez le cadre, le siège et le dossier avec un chiffon doux et de l'eau chaude. Nettoyez les accoudoirs avec un chiffon humide et n'utilisez jamais de détergent. Pour préserver leurs magnifiques finitions en bois, les fauteuils repas et les fauteuils club SEAX avec accoudoirs en contreplaqué de teck doivent être protégés de l'humidité et conservés à l'intérieur lorsqu'ils ne sont pas utilisés. Pour un choix d'entretien moins contraignant, choisissez le fauteuil repas et le fauteuil club sans accoudoirs en contreplaqué de teck.

SEAT CUSHION ARMCHAIR  
Sitzkissen Armlehnstuhl  
Cojín de asiento Silla con brazos  
Cuscino seduta Poltrona pranzo  
Coussin d'assise Fauteuil repas



ALL ITEMS ARE FOLDABLE.  
Alle Produkte sind faltbar.  
Todas las piezas son plegables.  
Tutti gli articoli sono pieghevoli.  
Tous les modèles sont pliables.



DINING TABLE  
Esstisch  
Mesa comedor  
Tavolo pranzo  
Table repas  
100 x 100 cm  
40,5 kg 0,75 m<sup>3</sup>



Set: 702076204 white / black



Set: 702076203 ebony / black



Set: 702076205 teak / black



Set: 701076204 white / white



Set: 701076203 ebony / white



Set: 701076205 teak / white

30 kg 0,75 m<sup>3</sup>

DINING TABLE  
Esstisch  
Mesa comedor  
Tavolo pranzo  
Table repas  
100 x 220 cm  
82 kg 1,65 m<sup>3</sup>



Set: 702040204 white / black



Set: 702040203 ebony / black



Set: 702040205 teak / black

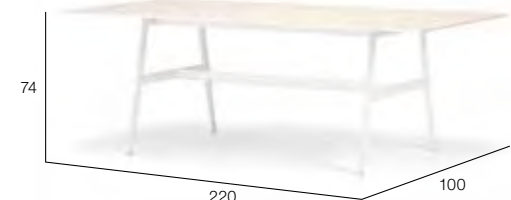

Set: 701040204 white / white



Set: 701040203 ebony / white

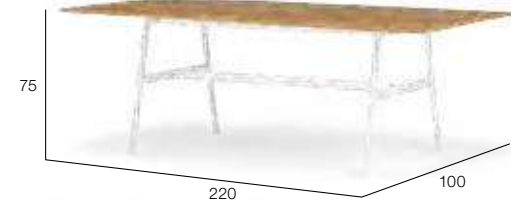

Set: 701040205 teak / white

52 kg 1,65 m<sup>3</sup>



DINING TABLE  
Esstisch  
Mesa comedor  
Tavolo pranzo  
Table repas  
**100 x 280 cm**  
99 kg 2,1 m<sup>3</sup>



Set: 702067**204** white / black

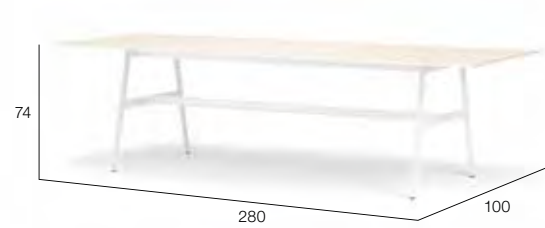

Set: 701067**204** white / white

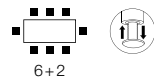

6+2



74



280

100

56700067000



Set: 702067**203** ebony / black



Set: 701067**203** ebony / white



Set: 702067**205** teak / black

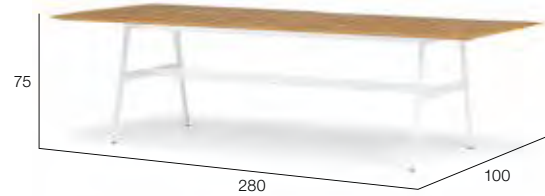

Set: 701067**205** teak / white

75

280

100

63 kg 2,1 m<sup>3</sup>

DINING TABLE  
Esstisch  
Mesa comedor  
Tavolo pranzo  
Table repas  
**ø 140 cm**  
56,5 kg 1,47 m<sup>3</sup>



Set: 702046**204** white / black



Set: 701046**204** white / white

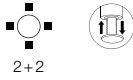

2+2



74



ø 140

56700046000



Set: 702046**203** ebony / black



Set: 701046**203** ebony / white



Set: 702046**205** teak / black



Set: 701046**205** teak / white

75

ø 140

39 kg 1,47 m<sup>3</sup>

COFFEE TABLE  
Kaffeetisch  
Mesa de centro  
Tavolino da salotto  
Table de salon  
**ø 110 cm**  
40 kg 0,56 m<sup>3</sup>



Set: 702036**204** white / black



Set: 701036**204** white / white

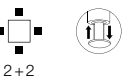

2+2



47



ø 110

56700036000



Set: 702036**203** ebony / black



Set: 701036**203** ebony / white



Set: 702036**205** teak / black



Set: 701036**205** teak / white

47

ø 110

23 kg 0,56 m<sup>3</sup>

### Tabletop Teak



**205** teak

### Tabletops Mineral-Composite



**204** white



**203** ebony

**EN** The **base** consists of powdercoated aluminum profiles with powdercoated, die-cast aluminum legs.  
**Tabletops** come in two options: Ebony and white tabletops consist of a self-supporting mineral-composite slab, cut by water jet from the largest premium sintered porcelain slabs available on the market. Teak tabletop consists of premium teak. The sealant used between the teak slats are the same as those widely used on yacht decks and are designed to expand and contract with teak's natural movement.

**DE** Das **Gestell** besteht aus pulverbeschichteten Aluminium-Profilen mit pulverbeschichteten Aludruckgussbeinen. Die **Tischplatten** sind in zwei Varianten verfügbar: ebony und white. Sie bestehen aus einem freitragenden Mineralverbundmaterial, das per Wasserstrahl aus den größten am Markt erhältlichen gesinterten Porzellanplatten geschnitten wird. Die Teak Tischplatte besteht aus hochwertigem Teakholz. Dichtungsfugen zwischen den Teakleisten erlauben dem Holz, sich im Rahmen seiner natürlichen Bewegung auszudehnen bzw. zusammenzuziehen.

**ES** La **base** combina perfiles de aluminio recubierto en polvo con patas de aluminio fundido recubierto en polvo. Los **tableros** están disponibles en dos opciones: ebony y white. Consisten en una placa autoportante de compuesto mineral que ha sido cortada mediante chorro de agua a partir de las placas de excelente porcelana sinterizada, las más grandes del mercado. El tablero de teca está elaborado con teca premium. Las juntas entre las lamias de teca, muy usadas en las cubiertas de los yates, permiten que la madera se expanda y se contraiga respetando su movimiento natural.

**IT** La **base** è composta da profili in alluminio con gambe in alluminio pressofuso e verniciatura a polvere. Il **piano del tavolo** è disponibile in due colori: Presentati in ebano e bianco, i piani sono formati da lastre autoportanti in minerale composito tagliate a getto d'acqua e ricavate dalle più ampie lastre in porcellana sinterizzata di alta qualità disponibili sul mercato. Il piano in teak è realizzato con teak di alta qualità. Lo speciale sigillante inserito tra le assi è lo stesso utilizzato sui ponti degli yacht, ed è pensato per espandersi e restringersi assecondando i movimenti naturali del teak.

**FR** La **base** est fabriqué à partir de profilés en aluminium thermolaqué avec des pieds en aluminium moulé et thermolaqué. Les **plateaux de tables** sont disponibles en deux variantes : ebony et white. Ils sont fabriqués dans un matériau minéral composite autoportant, lequel est découpé par jet hydraulique à partir des meilleures plaques de porcelaine frittées disponibles sur le marché. Le plateau de table est aussi proposé en teak de qualité supérieure. L'enduit entre les lamelles de teak est le même que celui utilisé sur les ponts de yachts : il est conçu pour gonfler et se contracter avec le mouvement naturel du teak.





2x Deck chair

Combinations

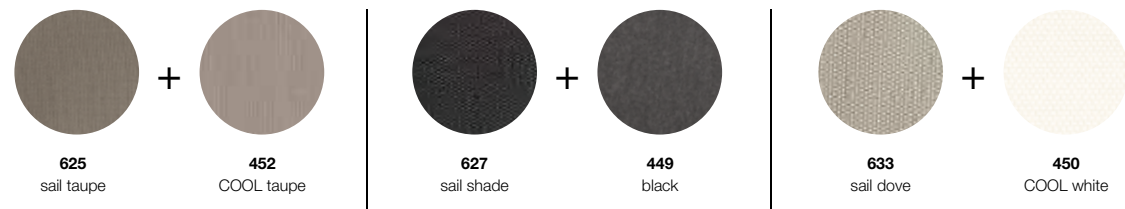

DECK CHAIR  
Liegestuhl  
Silla plegable  
Sedia a sdraio  
Transat  
10,2 kg 0,64 m³



SEAT CUSHION  
Sitzkissen  
Cojín de asiento  
Cuscino seduta  
Coussin d'assise  
63 x 48 x 10 cm



102005

102005627

95102005449

56102005000

DECK CHAIR  
Liegestuhl  
Silla plegable  
Sedia a sdraio  
Transat  
10,2 kg 0,64 m³

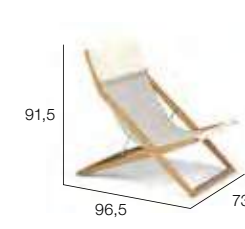

SEAT CUSHION  
Sitzkissen  
Cojín de asiento  
Cuscino seduta  
Coussin d'assise  
63 x 48 x 10 cm



102005

102005633

95102005450

56102005000

DECK CHAIR  
Liegestuhl  
Silla plegable  
Sedia a sdraio  
Transat  
10,2 kg 0,64 m³

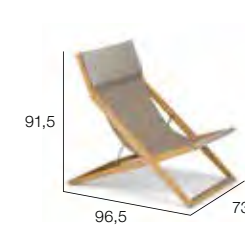

SEAT CUSHION  
Sitzkissen  
Cojín de asiento  
Cuscino seduta  
Coussin d'assise  
63 x 48 x 10 cm



102005

102005625

95102005452

56102005000

SEAT CUSHION  
Sitzkissen  
Cojín de asiento  
Cuscino seduta  
Coussin d'assise  
63 x 48 x 10 cm

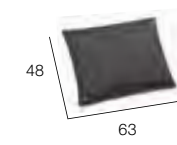

95102005449

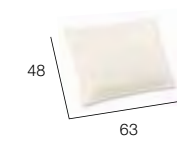

95102005450

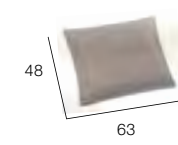

95102005452

**EN** The seat of the SEAYOU deck chair consists of a combination of SEAX sling material and outdoor fabric, while the base is made of premium teak. Clean the seat with a soft cloth and warm water. Clean the teak base with warm water in which natural soap flakes have been dissolved. The headrest cushion is removable. The fabric of the additional seat cushion corresponds to the fabric of the headrest cushion.

**DE** Die Sitzfläche des SEAYOU Liegestuhls besteht aus einer Kombination aus SEAX Sling Material und Outdoor Stoff, während das Gestell aus hochwertigem Premium Teak gefertigt wird. Reinigen Sie die Sitzfläche mit einem weichen Tuch und warmem Wasser. Teak reinigen Sie am besten mit lauwarmem Wasser unter Hinzugabe von materialschonender Naturseife. Das Nackenkissen ist abnehmbar. Das optionale Sitzkissen wird in demselben Stoff gefertigt wie das Nackenkissen.

**ES** La superficie de la silla plegable SEAYOU es una combinación de material de tensor SEAX y tejido para exteriores, mientras que la base está fabricada de teca premium. Limpiar el asiento con un paño húmedo y agua tibia. Limpiar la teca con agua tibia en la que se haya disuelto jabón natural. El cojín reposacabezas es extraíble. El tejido del cojín adicional del asiento va a juego con el tejido del cojín del reposacabezas.

**IT** La seduta della sedia a sdraio SEAYOU è composta da una combinazione di fettucia in SEAX e di tessuto per esterni, mentre la base è in pregiato teak. Pulire la seduta con un panno morbido e acqua tiepida. Pulire la base in teak con acqua tiepida nella quale sono state dissolte scaglie di sapone naturale. Il cuscino poggiatesta è removibile. Il tessuto del cuscino della seduta aggiuntiva è coordinato al tessuto del cuscino poggiatesta.

**FR** Le siège du transat SEAYOU combine du matériel SEAX Sling et du tissu pour l'extérieur, le tout posé sur un cadre en teak de qualité supérieure. Utilisez un chiffon doux et de l'eau chaude pour nettoyer l'assise. Nettoyez les parties en teak avec de l'eau tiède, de préférence, agrémentée de savon naturel non agressif. Le coussin repose-tête est amovible. Le coussin d'assise en option est fabriqué avec le même tissu que le coussin repose-tête.





3-seater  
Bench  
Cushion: TWIST sand 661

Recommended combinations

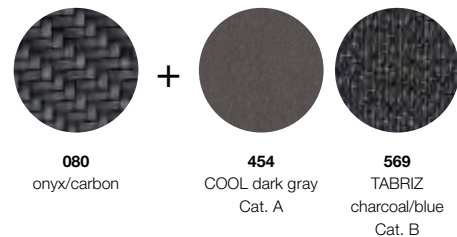

LOUNGE CHAIR  
Sessel  
Sillón bajo  
Poltrona club  
Fauteuil club  
21 kg 0,55 m<sup>3</sup>



044005080

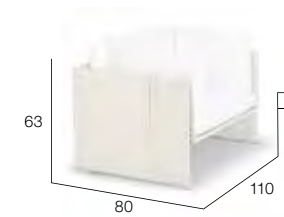

044005083

SEAT CUSHION + BACK CUSHION + 2x SIDE CUSHION  
Sitzkissen + Rückenkissen + 2x Seitenkissen  
Cojín de asiento + Cojín de respaldo + 2x Cojín lateral  
Cuscino seduta + Cuscino schienale + 2x Cuscino laterale  
Coussin d'assise + Coussin de dossier + 2x Coussin latéral  
93 x 71 cm + 99 x 44 cm + 2x 68 x 44 cm



044005

95044005

56044005000

FOOTSTOOL  
Hocker  
Taburete  
Pouf  
Repose-pieds  
8 kg 0,14 m<sup>3</sup>



044031080

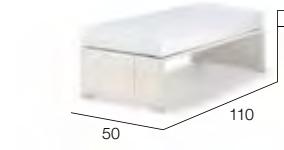

044031083

SEAT CUSHION  
Sitzkissen  
Cojín de asiento  
Cuscino seduta  
Coussin d'assise  
105 x 50 cm



044031

95044031

56044031000

3-SEATER  
3er-Sofa  
Sofá 3 plazas  
Divano 3 posti  
Canapé 3 places  
32 kg 1,01 m<sup>3</sup>



044015080



044015083

SEAT CUSHION + 2x BACK CUSHION + 2x SIDE CUSHION  
Sitzkissen + 2x Rückenkissen + 2x Seitenkissen  
Cojín de asiento + 2x Cojín de respaldo + 2x Cojín lateral  
Cuscino seduta + 2x Cuscino schienale + 2x Cuscino laterale  
Coussin d'assise + 2x Coussin de dossier + 2x Coussin latéral  
180 x 71 cm + 2x 95 x 44 cm + 2x 68 x 44 cm



044015

95044015

56044015000

4-SEATER  
4er-Sofa  
Sofá 4 plazas  
Divano 4 posti  
Canapé 4 places  
45,5 kg 1,26 m<sup>3</sup>



044017080



044017083

SEAT CUSHION + 2x BACK CUSHION + 2x SIDE CUSHION  
Sitzkissen + 2x Rückenkissen + 2x Seitenkissen  
Cojín de asiento + 2x Cojín de respaldo + 2x Cojín lateral  
Cuscino seduta + 2x Cuscino schienale + 2x Cuscino laterale  
Coussin d'assise + 2x Coussin de dossier + 2x Coussin latéral  
230 x 71 cm + 2x 124 x 44 cm + 2x 68 x 44 cm



044017

95044017

56044017000

SOFA RIGHT  
Sofa rechts  
Sofá con apoyo a la derecha  
Divano destro  
Canapé avec accoudoir à droite  
27,4 kg 0,86 m<sup>3</sup>



044014080



044014083

SEAT CUSHION + 2x BACK CUSHION + SIDE CUSHION  
Sitzkissen + 2x Rückenkissen + Seitenkissen  
Cojín de asiento + 2x Cojín de respaldo + Cojín lateral  
Cuscino seduta + 2x Cuscino schienale + Cuscino laterale  
Coussin d'assise + 2x Coussin de dossier + Coussin latéral  
158 x 71 cm + 2x 166 x 44 cm + 65 x 44 cm



044014

95044014

56044014000

SOFA LEFT  
Sofa links  
Sofá con apoyo a la izquierda  
Divano sinistro  
Canapé avec accoudoir à gauche  
27,4 kg 0,86 m<sup>3</sup>



044016080



044016083

SEAT CUSHION + 2x BACK CUSHION + SIDE CUSHION  
Sitzkissen + 2x Rückenkissen + Seitenkissen  
Cojín de asiento + 2x Cojín de respaldo + Cojín lateral  
Cuscino seduta + 2x Cuscino schienale + Cuscino laterale  
Coussin d'assise + 2x Coussin de dossier + Coussin latéral  
158 x 71 cm + 2x 166 x 44 cm + 65 x 44 cm



044016

95044016

56044016000

RECOMMENDED DECO CUSHIONS  
Empfohlene Dekokissen  
Cojines decoración recomendados  
Cuscini decorativi consigliati  
Coussins déco recommandés

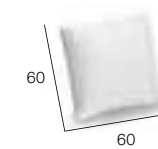

95050084

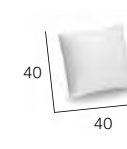

95050081



BEACH CHAIR  
 Sonnenliege  
 Tumbona  
 Lettino  
 Chaise longue  
 27,5 kg 0,36 m<sup>3</sup>



044019080

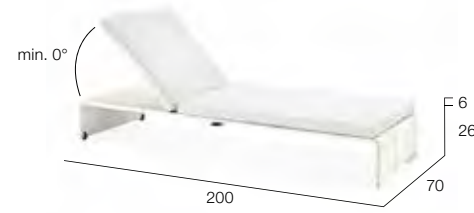

044019083

CUSHION  
 Kissen  
 Cojín  
 Cuscino  
 Coussin  
 197 x 70 cm



95044019 56044019000

BENCH  
 Bank  
 Banqueta  
 Panca  
 Banc  
 13 kg 0,26 m<sup>3</sup>



044012080

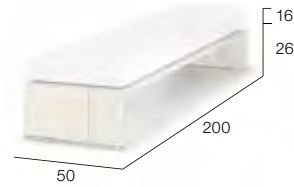

044012083

SEAT CUSHION  
 Sitzkissen  
 Cojín de asiento  
 Cuscino seduta  
 Coussin d'assise  
 195 x 50 cm



95044012 56044012000

FOOTSTOOL / COFFEE TABLE  
 Hocker / Kaffeetisch  
 Taburete / Mesa de centro  
 Pouf / Tavolino da salotto  
 Table de salon  
 80 x 80 cm  
 9,5 kg 0,17 m<sup>3</sup>



044037080

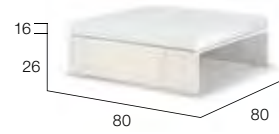

044037083

SEAT CUSHION  
 Sitzkissen  
 Cojín de asiento  
 Cuscino seduta  
 Coussin d'assise  
 80 x 80 cm



95044038 56044038000

044037



044037080

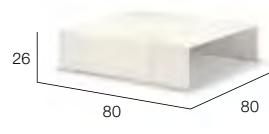

044037083



56044037000

SIDE TABLE  
 Beistelltisch  
 Mesa auxiliar  
 Tavolino d'appoggio  
 Table d'appoint  
 40 x 78 cm  
 7 kg 0,16 m<sup>3</sup>



044033080

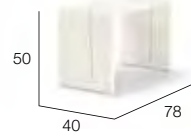

044033083



56044033000

044033

## SLIM LINE

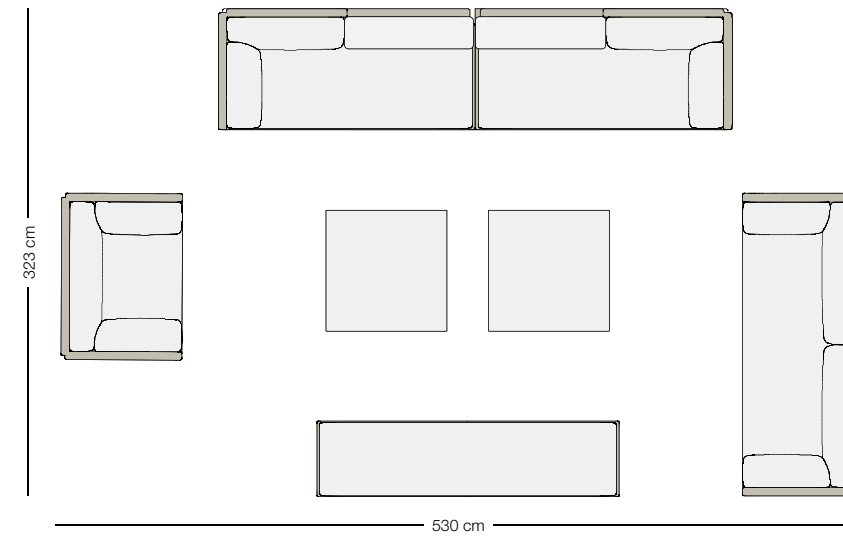
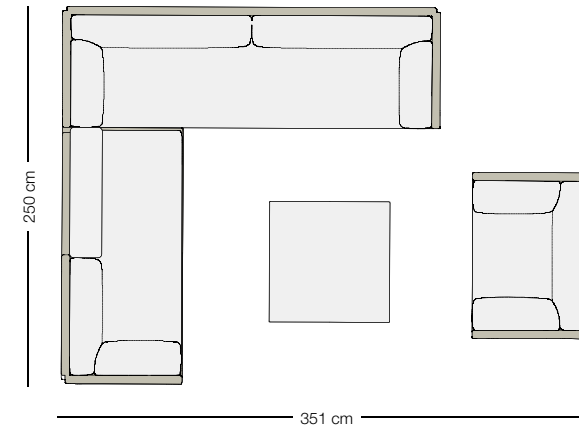
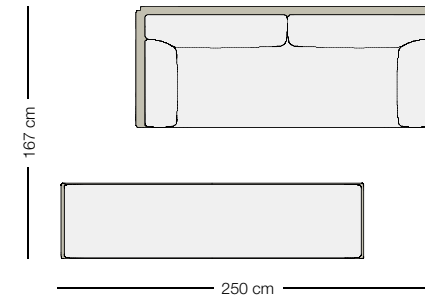

## OPTIONAL COMBINATIONS

### SLIM LINE Setting 01

1x 044015 – 3-seater, Seat cushion + 2x Back cushion + 2x Side cushion  
 1x 044012 – Bench, Seat cushion

Recommended deco cushions:

1x 95050081 – 40 x 40 cm  
 1x 95050084 – 60 x 60 cm

For inspiration please see page 242

### SLIM LINE Setting 02

1x 044014 – Sofa right, Seat cushion + 2x Back cushion + 1x Side cushion  
 1x 044017 – 4-seater, Seat cushion + 2x Back cushion + 2x Side cushion  
 1x 044005 – Lounge chair, Seat cushion + Back cushion + 2x Side cushion  
 1x 044037 – Coffee table 80 x 80 cm

Recommended deco cushions:

3x 95050081 – 40 x 40 cm  
 2x 95050084 – 60 x 60 cm

### SLIM LINE Setting 03

1x 044005 – Lounge chair, Seat cushion + Back cushion + 2x Side cushion  
 1x 044014 – Sofa right, Seat cushion + 2x Back cushion + 1x Side cushion  
 1x 044016 – Sofa left, Seat cushion + 2x Back cushion + 1x Side cushion  
 1x 044015 – 3-seater, Seat cushion + 2x Back cushion + 2x Side cushion  
 2x 044037 – Coffee table 80 x 80 cm  
 1x 044012 – Bench, Seat cushion

Recommended deco cushions:

5x 95050081 – 40 x 40 cm  
 1x 95050084 – 60 x 60 cm





Hanging lounge incl. canopy  
Cushion: COOL white 450

## Recommended combinations

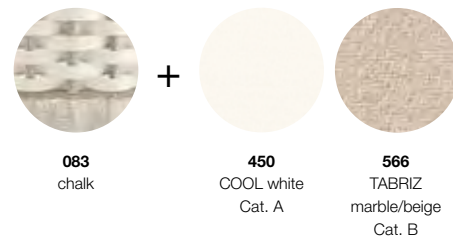
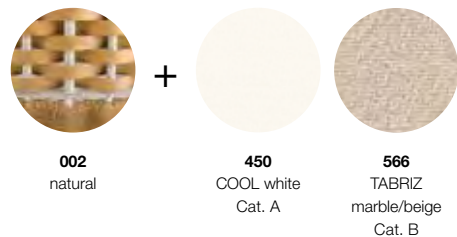

HANGING LOUNGER\*  
Hanging lounge  
Hanging lounge  
Hanging lounge  
Hanging lounge  
45 kg 2,53 m<sup>3</sup>

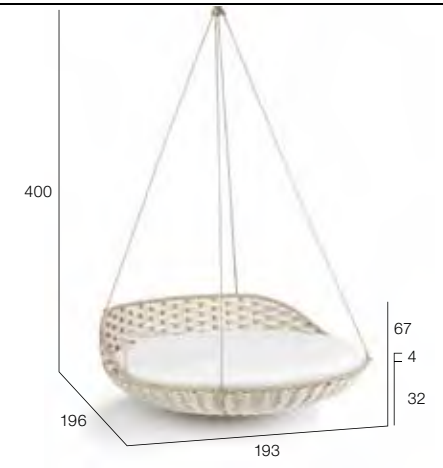

SEAT CUSHION  
Sitzkissen  
Cojín de asiento  
Cuscino seduta  
Coussin d'assise  
ø 192 x 16 cm

091021

091021002

091021083

95090119

0009120002

CANOPY FOR HANGING LOUNGER  
Himmel für Hanging lounge  
Velo para Hanging lounge  
Baldaquin pala Hanging lounge  
Baldaquin pour Hanging lounge

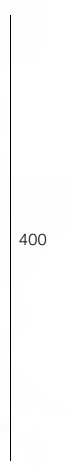

00091100000

STANDING LOUNGER, INCL. BASE\*  
Standing lounge, incl. base incl.  
Standing lounge, base incl.  
Standing lounge, avec socle  
52,2 kg 2,76 m<sup>3</sup>



SEAT CUSHION  
Sitzkissen  
Cojín de asiento  
Cuscino seduta  
Coussin d'assise  
ø 192 x 16 cm



091023

091023002

091023083

95090119

0009120002

BASE, ROTATING – SUITABLE FOR HANGING AND STANDING LOUNGER  
Untersatz, drehbar – passend für Hanging und Standing lounge  
Base rotatoria – adaptable para el hanging y standing lounge  
Base rotante – adatta per Hanging e Standing lounge  
Socle, rotatif – convient pour Hanging lounge et Standing lounge  
7,2 kg 0,15 m<sup>3</sup>



ø 121



091018

RECOMMENDED NUMBER OF DECO CUSHIONS  
Empfohlene Dekokissenmenge  
Número de cojines decoración recomendados  
Numero di cuscini decorativi  
Nombre de coussins déco recommandé

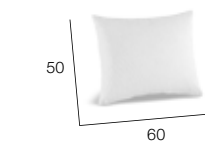

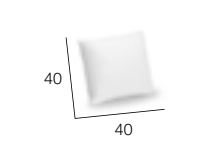

6x 95050087



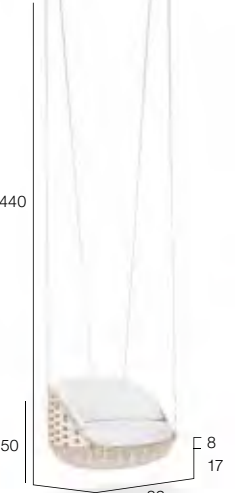

4x 95050081

\* EN Weight capacity 350 kg DE Tragkraft 350 kg ES Capacidad de carga 350 kg IT Portata 350 kg FR Capacité de charge 350 kg



<p>SWINGME LOUNGE CHAIR*          SwingMe Sessel          SwingMe Colupio individual          SwingMe Poltrona club          SwingMe Fauteuil club          11 kg 0,36 m<sup>3</sup></p>		 <p>440 50 81 89 8 17</p>	<p>SEAT CUSHION          Sitzkissen          Cojín de asiento          Cuscino seduta          Coussin d'assise          85 x 78 cm</p>	<p>BACK CUSHION          Rückenkissen          Cojín de respaldo          Cuscino schienale          Coussin de dossier          152 x 29 cm</p>	
<p><b>091005+091012000</b></p>	<p>Set: 091017002</p>	<p>Set: 091017083</p>	<p><b>95091005</b></p>	<p><b>95091006</b></p>	<p><b>56091005000</b></p>

<p>LOUNGE CHAIR**          Sessel          Sillón bajo          Poltrona club          Fauteuil club          23 kg 0,51 m<sup>3</sup></p>		 <p>71 81 89 8 38</p>	<p>SEAT CUSHION          Sitzkissen          Cojín de asiento          Cuscino seduta          Coussin d'assise          85 x 78 cm</p>	<p>BACK CUSHION          Rückenkissen          Cojín de respaldo          Cuscino schienale          Coussin de dossier          152 x 29 cm</p>	
<p><b>091007</b></p>	<p>091007002</p>	<p>091007083</p>	<p><b>95091005</b></p>	<p><b>95091006</b></p>	<p><b>56091005000</b></p>

<p>RECOMMENDED NUMBER OF DECO CUSHIONS          Empfohlene Dekokissenmenge          Número de cojines decoración recomendados          Numero di cuscini decorativi          Nombre de coussins déco recommandé</p>	 <p>50 50</p>	 <p>40 40</p>	<p><b>1x 95050082</b></p>	<p><b>2x 95050081</b></p>
---	---	--	---------------------------	---------------------------

<p>SWINGUS 2-SEATER***          SwingUs 2er-Sofa          SwingUs Colupio 2 plazas          SwingUs Divanetto 2 posti          SwingUs Canapé 2 places          15 kg 0,54 m<sup>3</sup></p>		 <p>440 50 81 133 8 17</p>	<p>SEAT CUSHION          Sitzkissen          Cojín de asiento          Cuscino seduta          Coussin d'assise          124 x 78 cm</p>	<p>BACK CUSHION          Rückenkissen          Cojín de respaldo          Cuscino schienale          Coussin de dossier          204 x 29 cm</p>	
<p><b>091012+091012000</b></p>	<p>Set: 091015002</p>	<p>Set: 091015083</p>	<p><b>95091012</b></p>	<p><b>95091013</b></p>	<p><b>56091012000</b></p>

<p>* <b>EN</b> Weight capacity 120 kg <b>DE</b> Tragkraft 120 kg <b>ES</b> Capacidad de carga 120 kg <b>IT</b> Portata 120 kg <b>FR</b> Capacité de charge 120 kg</p>	<p>** <b>EN</b> Weight capacity 150 kg <b>DE</b> Tragkraft 150 kg <b>ES</b> Capacidad de carga 150 kg <b>IT</b> Portata 150 kg <b>FR</b> Capacité de charge 150 kg</p>	<p>*** <b>EN</b> Weight capacity 240 kg <b>DE</b> Tragkraft 240 kg <b>ES</b> Capacidad de carga 240 kg <b>IT</b> Portata 240 kg <b>FR</b> Capacité de charge 240 kg</p>
---	--	---

<p><b>EN</b> Rope length may be customized upon request.</p>	<p><b>DE</b> Die Seillänge kann auf Anfrage nach Kundenwünschen angepasst werden.</p>	<p><b>ES</b> Se puede personalizar la longitud del cordón de acuerdo a los requisitos del cliente bajo pedido.</p>	<p><b>IT</b> Il cliente può ordinare la corda della lunghezza desiderata.</p>	<p><b>FR</b> La longueur de la corde peut être modifiée sur demande et adaptée selon le souhait des clients.</p>
--	---	--	---	--

<p>CANOPY FOR SWINGUS 2-SEATER          Himmel für SwingUs 2er-Sofa          Velo para SwingUs Colupio 2 plazas          Baldaquin para SwingUs Divanetto 2 posti          Baldaquin pour SwingUs Canapé 2 places</p>		 <p>230</p>	
<p><b>00091015000</b></p>			

<p><b>EN</b> The SWINGREST canopy is made of 100% solution-dyed outdoor acrylic fabric with a color fastness of 7/8. It has a mold-resistant, soil-resistant and water-resistant finishing made with Teflon®. The aluminum ring is wrapped with rope.</p>	<p><b>DE</b> Der SWINGREST Himmel besteht aus 100% spinnfärbem Outdoor-Acrylstoff mit einer Lichtechtheit von 7/8. Dank einer Teflon®-Beschichtung ist der Stoff schimmel-, schmutz- und wasserabweisend. Der Aluminiumring ist mit einem Seil umwickelt.</p>	<p><b>ES</b> El velo SWINGREST está hecho de tejido acrílico 100% teñido en masa para exteriores con una solidez de color de 7/8. Cuenta con un acabado de Teflon® resistente al moho, la suciedad y el agua. La anilla de aluminio está revestida con cuerda acrílica.</p>	<p><b>IT</b> La tenda SWINGREST è in tessuto acrilico tinto in massa per esterni 100% acrilico tinto in massa con una stabilità di colore di 7/8. Ha un rivestimento in Teflon® resistente alla muffa, allo sporco e all'acqua. L'anello di alluminio è rivestito di corda.</p>	<p><b>FR</b> Le baldaquin SWINGREST est entièrement composé de matière acrylique teinte et adaptée à l'utilisation en extérieur, avec un indice de tenue de couleur de 7/8. Sa finition en Teflon® est résistante aux moisissures, à la salâté et à l'eau. Son anneau en aluminium est enveloppé de corde.</p>
---	---	---	---	--

<p>2-SEATER          2er-Sofa          Sofá 2 plazas          Divanetto 2 posti          Canapé 2 places          15 kg 0,76 m<sup>3</sup></p>		 <p>71 81 133 8 38</p>	<p>SEAT CUSHION          Sitzkissen          Cojín de respaldo          Cuscino seduta          Coussin d'assise          124 x 78 cm</p> <p>BACK CUSHION          Rückenkissen          Cojín de respaldo          Cuscino schienale          Coussin de dossier          204 x 29 cm</p>
<p><b>091012+091013001</b></p>	<p>Set: 091014002</p>	<p>Set: 091014083</p>	<p><b>95091012</b></p> <p><b>95091013</b></p> <p><b>56091012000</b></p>

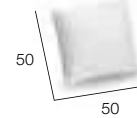
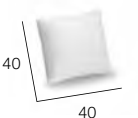
<p>RECOMMENDED NUMBER OF DECO CUSHIONS          Empfohlene Dekokissenmenge          Número de cojines decoración recomendados          Numero di cuscini decorativi          Nombre de coussins déco recommandé</p>	 <p>50 50</p>	 <p>40 40</p>	<p><b>3x 95050082</b></p> <p><b>2x 95050081</b></p>
---	--	--	---



<p><b>EN</b> The SwingMe Lounge chair and SwingUs 2-seater may be hung either from a single point, for a rotating swing experience, or from two points, for a back-and-forth one. The canopy for the SwingUs 2-seater fits only when the piece is hung from a single point.</p>	<p><b>DE</b> Der SwingMe Sessel und das SwingUs 2er-Sofa können entweder an einem oder zwei Hängepunkten befestigt werden. Dadurch werden rotierende oder geradlinige Schaukelbewegungen erzielt. Der Himmel für das SwingUs 2er-Sofa kann nur befestigt werden, wenn das Möbelstück an einem einzigen Hängepunkt montiert wurde.</p>	<p><b>ES</b> El sillón bajo SwingMe y el sofá de dos plazas SwingUs pueden colgarse en un solo punto para obtener un movimiento rotatorio o en dos puntos para conseguir un movimiento de balanceo. El baldaquin para el sofá de dos plazas SwingUs solo se puede fijar si este está colgado de un solo punto.</p>	<p><b>IT</b> La poltrona SwingMe e il divano a due posti SwingUs possono essere appesi sia da un unico punto, con un effetto rotatorio e oscillante, sia da due punti, con un effetto di movimento avanti e indietro. La tenda per il divano a due posti SwingUs può essere collocata solo se il mobile è stato appeso da un unico punto.</p>	<p><b>FR</b> Le fauteuil SwingMe et le canapé 2 places SwingUs peuvent être suspendus soit à partir d'un point d'attache unique, pour un balancement avec rotation, soit à partir de deux points d'attache différents, pour un balancement d'avant en arrière. Le baldaquin au-dessus du canapé 2 places SwingUs peut s'ajouter uniquement si le meuble est suspendu en un seul point.</p>
---	---	--	---	--





Armchair

ARMCHAIR  
Armlehnstuhl  
Silla con brazos  
Poltrona pranzo  
Fauteuil repas  
6 kg 0,31 m³



026001110

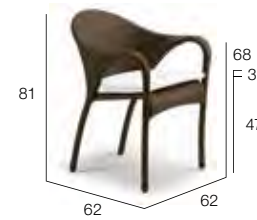

026001040

SEAT CUSHION  
Sitzkissen  
Cojín de asiento  
Cuscino seduta  
Coussin d'assise  
46 x 42 cm



95026001

56026001000

DINING TABLE  
Esstisch  
Mesa comedor  
Tavolo pranzo  
Table repas  
ø 90 cm  
7 kg 0,61 m³



Set: 026046110



Set: 026046040

CLEAR GLASS TOP  
Klarglasplatte  
Sobre de cristal transparente  
Piano in vetro trasparente  
Plaque en verre clair  
9 kg



2

22226045000

56026046000

DINING TABLE  
Esstisch  
Mesa comedor  
Tavolo pranzo  
Table repas  
ø 130 cm  
10 kg 1,27 m³



Set: 026050110



Set: 026050040

CLEAR GLASS TOP  
Klarglasplatte  
Sobre de cristal transparente  
Piano in vetro trasparente  
Plaque en verre clair  
19 kg



2+2

22226049000

56026050000

DINING TABLE  
Esstisch  
Mesa comedor  
Tavolo pranzo  
Table repas  
130 x 220 cm  
22 kg 2,15 m³



Set: 026076110



Set: 026076040

CLEAR GLASS TOP  
Klarglasplatte  
Sobre de cristal transparente  
Piano in vetro trasparente  
Plaque en verre clair  
33,5 kg



4+2

22226075000

56026076000

LOUNGE CHAIR  
Sessel  
Sillón bajo  
Poltrona club  
Fauteuil club  
9 kg 0,7 m³



026005110



026005040

SEAT CUSHION + BACK CUSHION  
Sitzkissen + Rückenissen  
Cojín de asiento + Cojín de respaldo  
Cuscino seduta + Cuscino schienale  
Coussin d'assise + Coussin de dossier  
61 x 58 cm + 50 x 60 cm



95026005

56026005000

2-SEATER  
2er-Sofa  
Sofá 2 plazas  
Divano 2 posti  
Canapé 2 places  
15 kg 1,44 m³



026012110



026012040

SEAT CUSHION + 2x BACK CUSHIONS  
Sitzkissen + 2x Rückenissen  
Cojín de asiento + 2x Cojines de respaldo  
Cuscino seduta + 2x Cuscini schienale  
Coussin d'assise + 2x Coussin de dossier  
132 x 58 cm + 2x 50 x 60 cm



95026012

56026012000

## Recommended combinations

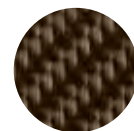

040  
bronze

+

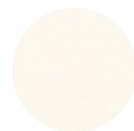

450  
COOL white  
Cat. A



660  
TWIST beige  
Cat. B



110  
basalto

+



452  
COOL taupe  
Cat. A

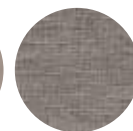

662  
TWIST gray  
Cat. B

## Tabletop Glass

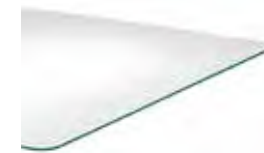

000 clear glass



BEACH CHAIR\*  
 Sonnenliege  
 Tumbona  
 Lettino  
 Chaise longue  
 17 kg 1,36 m<sup>3</sup>



026119110



026119040

CUSHION  
 Kissen  
 Cojín  
 Cuscino  
 Coussin  
 60 x 206 cm



95026019 56026019000

RECLINER\*  
 Liegesessel  
 Sillón reclinable  
 Poltrona reclinabile  
 Fauteuil relax réglable  
 13 kg 1 m<sup>3</sup>



026109110



026109040

CUSHION  
 Kissen  
 Cojín  
 Cuscino  
 Coussin  
 60 x 136 cm



95026009 56026009000

FOOTSTOOL  
 Hocker  
 Taburete  
 Pouf  
 Repose-pieds  
 6 kg 0,13 m<sup>3</sup>



026031110



026031040

SEAT CUSHION  
 Sitzkissen  
 Cojín de asiento  
 Cuscino seduta  
 Coussin d'assise  
 45 x 45 cm



95026031 56026031000

SIDE TABLE  
 Beistelltisch  
 Mesa auxiliar  
 Tavolino d'appoggio  
 Table d'appoint  
 ø 46 cm  
 4 kg 0,11 m<sup>3</sup>



Set: 026034110



Set: 026034040

CLEAR GLASS TOP  
 Klarglasplatte  
 Sobre de cristal transparente  
 Piano in vetro trasparente  
 Plaque en verre clair  
 2 kg



22226033000 56026033000

\* EN This item is also available with hook-catching mechanism upon request.

DE Dieser Artikel ist auf Anfrage auch mit Stufenverstellung erhältlich.

ES Bajo pedido este artículo también está disponible con un mecanismo de ajuste escalonado.

IT Questo articolo è disponibile su richiesta anche con meccanismo di regolazione reclinabile.

FR Cet article est disponible, sur demande, avec un mécanisme de réglage du niveau d'inclinaison.







6x Armchair  
Cushion: LINEN warm gray 652  
Dining table 103 x 278 cm

Recommended combinations: dining

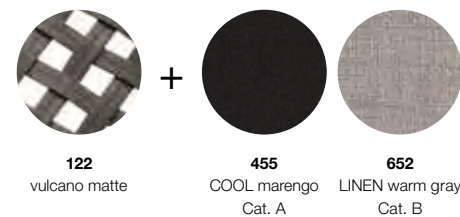

Recommended combinations: lounging

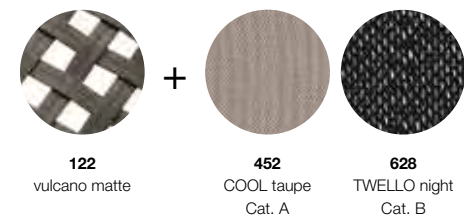

ARMCHAIR  
Armlehnstuhl  
Silla con brazos  
Poltrona pranzo  
Fauteuil repas  
7 kg 0,3 m<sup>3</sup>



4,5

SEAT CUSHION  
Sitzkissen  
Cojín de asiento  
Cuscino seduta  
Coussin d'assise  
51 x 50 cm



CUSHION  
Kissen  
Cojín  
Cuscino  
Coussin  
56 x 102 cm



089001

95089003

089001122

95089002

56089001000

DINING TABLE  
Esstisch  
Mesa comedor  
Tavolo pranzo  
Table repas  
103 x 119 cm  
29 kg 0,9 m<sup>3</sup>



119

103

74

089075205



089075

56089075000

DINING TABLE  
Esstisch  
Mesa comedor  
Tavolo pranzo  
Table repas  
103 x 199 cm  
43 kg 1,5 m<sup>3</sup>

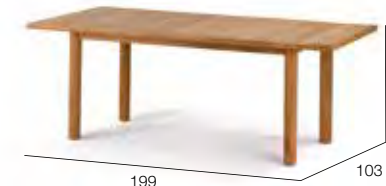

199

103

74

089065205



089065

56089065000

DINING TABLE  
Esstisch  
Mesa comedor  
Tavolo pranzo  
Table repas  
103 x 278 cm  
56 kg 2,1 m<sup>3</sup>



278

103

74

089055205



089055

56089055000

DINING TABLE  
Esstisch  
Mesa comedor  
Tavolo pranzo  
Table repas  
103 x 338 cm  
66 kg 2,6 m<sup>3</sup>



338

103

74

089045205



089045

56089045000

BENCH  
Bank  
Banco  
Panca  
Banc  
14 kg 0,25 m<sup>3</sup>



130

40

44

089012205

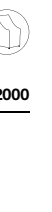

089012

56089012000

BENCH L  
Bank L  
Banco L  
Panca a L  
Banc L  
22 kg 0,35 m<sup>3</sup>

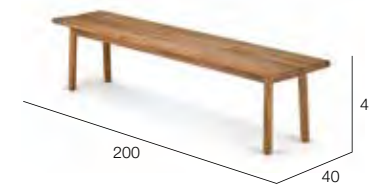

200

40

44

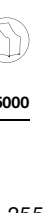

089015205







089015

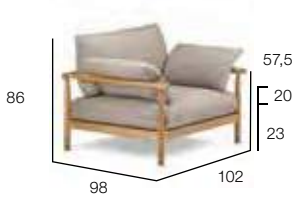

56089015000



<p>LOUNGE CHAIR Sessel Sillón bajo Poltrona club Fauteuil club 9 kg 0,36 m³</p>		<p>CUSHION Kissen Cojín Cuscino Coussin 69 x 109,5 cm</p>	  
<b>089005</b>	<b>089005122</b>	<b>95089005</b>	<b>5608900500</b>

<p>LOUNGE CHAIR XL Sessel XL Sillón bajo XL Poltrona club XL Fauteuil club XL 15,4 kg 0,85 m³</p>		<p>SEAT CUSHION + BACK CUSHION + 2x SIDE CUSHIONS Sitzkissen + Rückenkissen + 2x Seitenkissen Cojín de asiento + Cojín de respaldo + 2x Cojines lateral Cuscino seduta + Cuscino schienale + 2x Cuscini laterale Coussin d'assise + Coussin de dossier + 2x Coussins latéraux 93 x 95 cm + 47 x 95 cm + 2x 63 x 43 cm</p>	
<b>089006</b>	<b>089006122</b>	<b>95089006</b>	<b>5608900600</b>



<p>2-SEATER 2er-Sofa Sofá 2 plazas Divano 2 posti Canapé 2 places 30 kg 1,1 m³</p>		<p>SEAT CUSHIONS + BACK CUSHIONS + 2x SIDE CUSHIONS Sitzkissen + Rückenkissen + 2x Seitenkissen Cojines de asiento + Cojines de respaldo + 2x Cojines lateral Cuscini seduta + Cuscini schienale + 2x Cuscini laterale Coussins d'assise + Coussins de dossier + 2x Coussins latéral 190 x 93 cm + 190 x 47 cm + 2x 63 x 43 cm</p>	
<b>089013</b>	<b>089013122</b>	<b>95089013</b>	<b>5608901300</b>

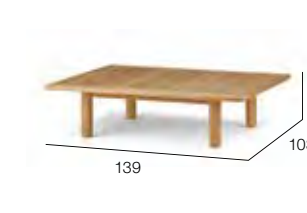

<p>3-SEATER 3er-Sofa Sofá 3 plazas Divano 3 posti Canapé 3 places 35,4 kg 1,6 m³</p>		<p>SEAT CUSHIONS + BACK CUSHIONS + 2x SIDE CUSHIONS Sitzkissen + Rückenkissen + 2x Seitenkissen Cojines de asiento + Cojines de respaldo + 2x Cojines lateral Cuscini seduta + Cuscini schienale + 2x Cuscini laterale Coussins d'assise + Coussins de dossier + 2x Coussins latéral 285 x 93 cm + 285 x 47 cm + 2x 63 x 43 cm</p>	
<b>089016</b>	<b>089016122</b>	<b>95089016</b>	<b>5608901600</b>

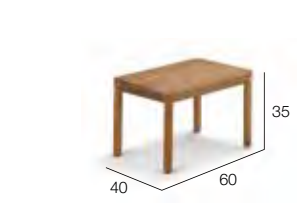
<p>COFFEE TABLE L Kaffeetisch L Mesa de centro L Tavolino da salotto L Table de salon L 103 x 139 cm 28,2 kg 0,5 m³</p>		<p><b>089037</b></p>	<p><b>089037205</b></p>	<p><b>56089037000</b></p>
---	---	----------------------	-------------------------	---------------------------

<p>COFFEE TABLE Kaffeetisch Mesa de centro Tavolino da salotto Table de salon 80 x 80 cm 10 kg 0,2 m³</p>		<p><b>089035</b></p>	<p><b>089035205</b></p>	<p><b>56089035000</b></p>
---	---	----------------------	-------------------------	---------------------------

<p>SIDE TABLE Beistelltisch Mesa auxiliar Tavolino d'appoggio Table d'appoint 60 x 40 cm 6 kg 0,09 m³</p>		<p><b>089039</b></p>	<p><b>089039205</b></p>	<p><b>56089039000</b></p>
---	---	----------------------	-------------------------	---------------------------

<p>BEACH CHAIR Sonnenliege Tumbona Lettino Chaise longue 25,6 kg 0,46 m³</p>		<p>CUSHION Kissen Cojín Cuscino Coussin 75 x 206 cm</p>	  
<b>089019</b>	<b>089019205</b>	<b>95089019</b>	<b>56089019000</b>

<p>BEACH CHAIR Sonnenliege Tumbona Lettino Chaise longue 26 kg 0,46 m³</p>		<p>CUSHION Kissen Cojín Cuscino Coussin 75 x 206 cm</p>	  
<b>089020</b>	<b>089020205</b>	<b>95089019</b>	<b>56089019000</b>

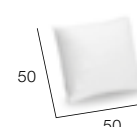
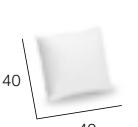
<p>RECOMMENDED DECO CUSHIONS Empfohlene Dekokissen Cojines decoración recomendados Cuscini decorativi consigliati Coussins déco recommandés</p>		
	<b>95050082</b>	<b>95050081</b>

## Tabletops Teak

	
<p><b>205 teak</b> TIBBO Dining table TIBBO Coffee table (103 x 139 cm)</p>	<p><b>205 teak</b> TIBBO Side table TIBBO Coffee table (80 x 80 cm)</p>

**EN** The frames of the TIBBO armchair and lounge chair are made of premium teak, while the seats consist of woven DEDON fiber. The beach chair has marine-grade stainless steel hinges, which we recommend cleaning periodically to prevent stains. Clean TIBBO products with warm water in which natural soap flakes have been dissolved.

**DE** Die Rahmen der TIBBO Armlehnstühle und Sessel bestehen aus hochwertigem Teakholz, während die Sitzflächen aus geflochtener DEDON Faser gefertigt werden. Die Scharniere der Sonnenliege bestehen aus rostfreiem Stahl (schiffbauliche „marine-grade“ Qualität). Wir empfehlen diese Verbindungen regelmäßig zu reinigen, um Flecken zu vermeiden. Die Möbel der TIBBO Kollektion reinigen Sie mit lauwarmem Wasser unter Hinzugabe von materialschonender Naturseife.

**ES** La estructura de la silla y el sillón bajo TIBBO están hechos de madera de teca de alta calidad, mientras que los asientos se componen de fibra tejida DEDON. Las bisagras de la tumbona están fabricadas de acero inoxidable (calidad naval "marine grade"). Se recomienda limpiar periódicamente estas uniones para evitar manchas. Lavar con agua templada y jabón natural en copos bien disuelto.

**IT** I telai della poltrona e della poltrona club TIBBO sono realizzati in teak di prima qualità, mentre le sedute sono in fibra intrecciata DEDON. Le cerniere del lettino sono in acciaio INOX (di qualità ad uso navale). Si raccomanda di pulirle regolarmente per impedire la formazione di macchie. Pulire i prodotti TIBBO con una soluzione composta da poco sapone neutro disciolto in acqua tiepida.

**FR** Les cadres du fauteuil repas et du fauteuil club TIBBO sont en teck de qualité supérieure. Les sièges sont, eux, fabriqués en fibre DEDON tissée. Les charnières des baignoires de soleil se composent d'acier inoxydable (identique à celui utilisé dans la construction navale). Nous recommandons un entretien régulier de ces charnières, afin d'éviter la formation de taches. Nettoyez les produits TIBBO avec du savon naturel en paillettes dilués dans de l'eau chaude.



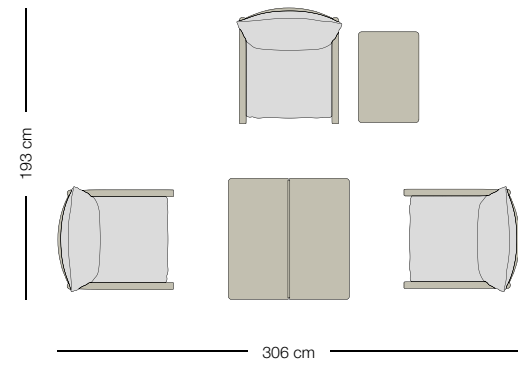

**TIBBO Setting 01**

- 3x 089005 – Lounge chair incl. Cushion
- 1x 089039205 – Side table
- 1x 089035205 – Coffee table

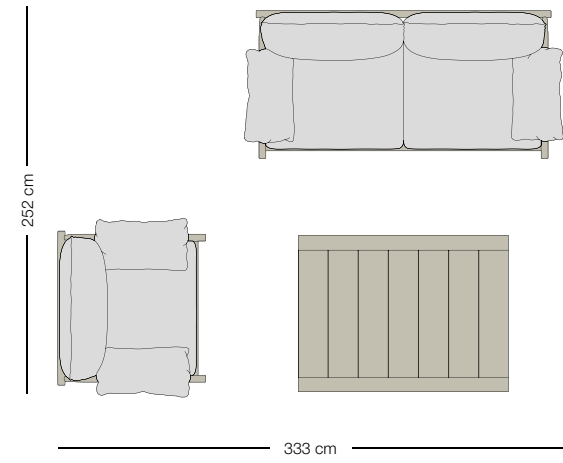

**TIBBO Setting 02**

- 1x 089013 – 2-Seater incl. Cushions
- 1x 089006 – Lounge chair XL incl. Cushions
- 1x 089037205 – Coffee table L 103 x 139 cm

Recommended deco cushions:  
 1x 95050081 – 40 x 40 cm  
 1x 95050085 – 50 x 40 cm

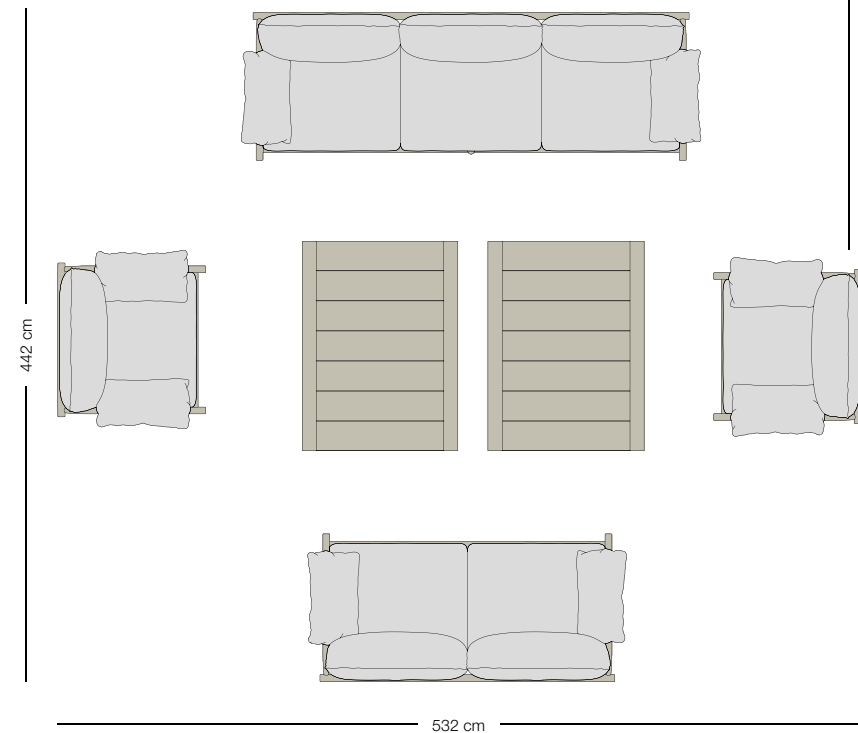

**TIBBO Setting 03**

- 1x 089016 – 3-Seater incl. Cushions
- 2x 089006 – Lounge chair XL incl. Cushions
- 2x 089037205 – Coffee table L 103 x 139 cm
- 1x 089013 – 2-Seater incl. Cushions

Recommended deco cushions:  
 4x 95050081 – 40 x 40 cm  
 3x 95050085 – 50 x 40 cm



2-Seater  
 Cushion: TWELLO right 628  
 Coffee table 103 x 139 cm





Deep sofa with roof (removable)  
Cushion: COOL white 450

Recommended combinations

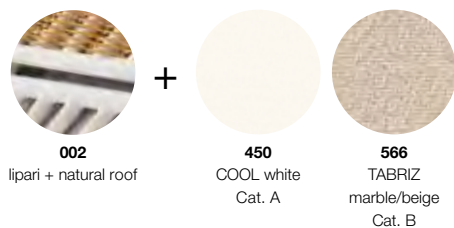

DEEP SOFA WITH ROOF (REMOVABLE)  
Tiefes Sofa mit Dach (abnehmbar)  
Sofá con mayor profundidad con dosel (desmontable)  
Divano con seduta profonda con tettuccio (removibile)  
Canapé à assise profonde avec toit (amovible)  
70 kg 5,6 m<sup>3</sup>

SEAT CUSHION + 2x BACK CUSHIONS + 2x SIDE CUSHIONS  
Sitzkissen + 2x Rückenkissen + 2x Seitenkissen  
Cojín de asiento + 2x Cojines de respaldo + 2x Cojines lateral  
Cuscino seduta + 2x Cuscini schienale + 2x Cuscini laterale  
Coussin d'assise + 2x Coussin de dossier + 2x Coussin latéral  
183 x 94 cm + 2x 98 x 50 cm + 2x 98 x 45 cm



Set: 076019002



95076018

56076019000

DEEP SOFA WITH ROOF (REMOVABLE)  
Tiefes Sofa mit Dach (abnehmbar)  
Sofá con mayor profundidad con dosel (desmontable)  
Divano con seduta profonda con tettuccio (removibile)  
Canapé à assise profonde avec toit (amovible)  
70 kg 5,6 m<sup>3</sup>

SEAT CUSHION + 2x BACK CUSHIONS + 2x SIDE CUSHIONS  
Sitzkissen + 2x Rückenkissen + 2x Seitenkissen  
Cojín de asiento + 2x Cojines de respaldo + 2x Cojines lateral  
Cuscino seduta + 2x Cuscini schienale + 2x Cuscini laterale  
Coussin d'assise + 2x Coussin de dossier + 2x Coussin latéral  
183 x 94 cm + 2x 98 x 50 cm + 2x 98 x 45 cm



Set: 076019083



95076018

56076019000

DEEP SOFA  
Tiefes Sofa  
Sofá con mayor profundidad  
Divano con seduta profonda  
Canapé à assise profonde  
32 kg 2,35 m<sup>3</sup>

SEAT CUSHION + 2x BACK CUSHIONS + 2x SIDE CUSHIONS  
Sitzkissen + 2x Rückenkissen + 2x Seitenkissen  
Cojín de asiento + 2x Cojines de respaldo + 2x Cojines lateral  
Cuscino seduta + 2x Cuscini schienale + 2x Cuscini laterale  
Coussin d'assise + 2x Coussin de dossier + 2x Coussin latéral  
183 x 94 cm + 2x 98 x 50 cm + 2x 98 x 45 cm



076018098

95076018

56076018000

**EN** This item comes with a set of base cushions made out of Batyline® fabric for the seat, back and sides. Batyline is a quick-drying, easy-to-clean polyester material with exceptional resistance to tearing and to outdoor conditions such as UV-light exposure. The base seat cushion is made out of a quick-drying foam. For better comfort, we recommend ordering a second layer of cushions made from our standard fabrics.

**DE** Dieser Artikel kommt mit einem Set aus Sitz-, Rücken- und Seitenkissen aus Batyline®-Stoff. Dieses schnelltrocknende und leicht zu reinigende Polyestermaterial ist sehr UV-beständig und reißfest. Das Sitzkissen hat einen schnelltrocknenden Schaumstoffkern. Zusätzlich kann eine zweite Lage Kissen zur Verbesserung des Komforts bestellt werden. Dieses ist erhältlich in unseren Standardstoffen.

**ES** El artículo incluye un asiento así como cojines laterales y de respaldo. Los cojines están cubiertos con textiles Batyline®; un material polyester de secado rápido y fácil limpieza con resistencia excepcional a desgarres y uso en exterior, incluyendo exposición solar. El asiento está hecho con espuma de secado rápido. Para un mejor confort, se recomienda adquirir la segunda capa de cojines que puede ser ordenada en cualquiera de nuestras telas en catálogo.

**IT** L'articolo viene con un set base di cuscini per seduta, schienale e laterale fatto in Batyline®, un materiale poliestere ad asciugatura rapida, facile da pulire con un'eccezionale resistenza agli strappi ed alle condizioni esterne come l'esposizione ai raggi UV. La base del cuscino della seduta ha un'imbottitura ad asciugatura rapida. Per un miglior confort, raccomandiamo ordinare un secondo strato fatto nei nostri tessuti standard.

**FR** Cet article est livré avec un set de coussins comprenant un coussin d'assise, un coussin de dossier et un coussin latéral, tous recouverts de toile Batyline®. Cette toile en fils polyester sèche très rapidement et est réputée pour sa facilité d'entretien, son extrême solidité et son exceptionnelle résistance aux conditions extérieures, notamment son exposition aux UV. Le coussin d'assise est composé d'une mousse à séchage rapide. Pour un meilleur confort, nous vous conseillons de commander des coussins de revêtement, conçus avec nos textiles habituels.





Dining table 100 x 200 cm  
white / HPL white

Tabletops HPL



000 white  
304 lipari  
305 vulcano

Tabletops glass



304 lipari glass  
305 vulcano glass  
Bottom: lacquered in lipari Bottom: lacquered in vulcano

Tabletop teak



205 teak

DINING TABLE  
Esstisch  
Mesa comedor  
Tavolo pranzo  
Table repas  
100 x 100 cm

34 kg 0,74 m³



601079001 white / HPL white



603079098 lipari / HPL lipari

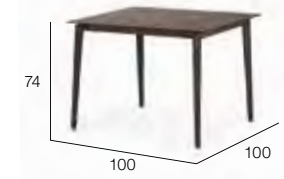

604079099 vulcano / HPL vulcano

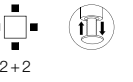

2+2



56057075000

45,5 kg 0,74 m³



601077098 white / glass lipari



603077098 lipari / glass lipari

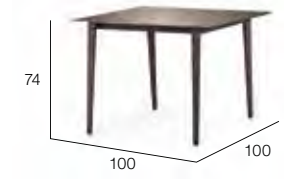

604077099 vulcano / glass vulcano

39,5 kg 0,75 m³



601060205 white / teak



603060205 lipari / teak

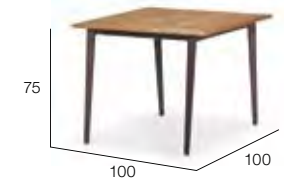

604060205 vulcano / teak

DINING TABLE  
Esstisch  
Mesa comedor  
Tavolo pranzo  
Table repas  
100 x 200 cm

50 kg 1,48 m³



601071001 white / HPL white



603071098 lipari / HPL lipari



604071099 vulcano / HPL vulcano

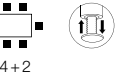

4+2



56057065000

73,5 kg 1,48 m³



601073098 white / glass lipari



603073098 lipari / glass lipari



604073099 vulcano / glass vulcano

44 kg 1,5 m³



601062205 white / teak



603062205 lipari / teak



604062205 vulcano / teak

DINING TABLE  
Esstisch  
Mesa comedor  
Tavolo pranzo  
Table repas  
100 x 250 cm

49,5 kg 1,9 m³



601064205 white / teak



603064205 lipari / teak

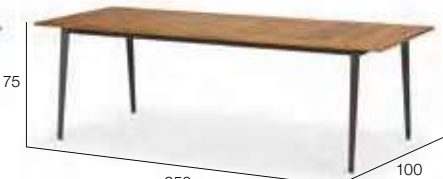

604064205 vulcano / teak

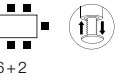

6+2



56600064000



COMPLEMENTARY CHAIRS



AllIR Armchair  
See page 145



PANAMA Armchair  
See page 211



PLAY Armchair  
See page 215



BARCELONA Armchair  
See page 153



MBRACE Armchair  
See page 198



SEASHELL Armchair  
See page 231

**EN** The WA table is available with a high-pressure laminate (HPL) top, a glass top and a teak top. HPL is a non-toxic material that is highly resistant to impact, mechanical stress, moisture and steam. Single-layered tempered glass offers increased resistance to temperature changes as well as excellent resistance to bending, impact and shock. The teak tabletop is made of premium teak. The WA tabletop support structure consists of powder-coated aluminum profiles, while the legs consist of die-cast powdercoated aluminum. Clean the support structure and legs with a soft cloth and warm water.

**DE** Der WA Tisch ist verfügbar mit einer „High Pressure Laminate“ (HPL) Platte, einer Glasplatte sowie einer Teak-Tischplatte. HPL ist ein ungiftiges Material, das sich durch hohe Stoßfestigkeit und extreme Widerstandskraft gegen mechanische Einwirkungen, Feuchtigkeit und Dampf auszeichnet. Das Einscheibensicherheitsglas verfügt über eine verbesserte Temperaturwechselbeständigkeit und weist eine sehr gute Biege-, Schlag- und Stoßfestigkeit auf. Die Teak Tischplatte besteht aus hochwertigem Teakholz. Die Beine sind aus gegossenem, pulverbeschichtetem Aluminium gefertigt. Einfach mit einem weichen Tuch und warmem Wasser zu reinigen.

**ES** Los tableros de la mesa WA están disponibles en tablero laminado a alta presión (HPL), cristal y teca. El HPL es un material no tóxico y muy resistente a impactos, cargas mecánicas, humedad y vapor. El cristal de seguridad monocapa ofrece una alta resistencia a los cambios de temperatura, así como a la flexión, a los impactos y a los golpes. El tablero de teca está hecho con teca de primera calidad. La estructura del soporte del tablero WA está hecha con perfiles de aluminio recubiertos en polvo, mientras que las patas son de aluminio fundido recubierto en polvo. Limpiar la estructura del soporte y las patas con un paño suave y agua tibia.

**IT** Il tavolo WA è disponibile con piano in laminato ad alta pressione (HPL), piano in vetro o piano in teak. L'HPL è un materiale atossico con elevata resistenza agli impatti, alle sollecitazioni meccaniche, all'umidità e al vapore. Il vetro di sicurezza a strato singolo offre una resistenza maggiore agli sbalzi di temperatura, alla flessione, agli impatti e agli urti. Il piano del tavolo è realizzato con teak di alta qualità. La struttura di sostegno del piano è formata da profili di alluminio verniciati a polvere, mentre le gambe del tavolo sono in alluminio pressofuso verniciato a polvere. Pulire la struttura di sostegno e le gambe con un panno morbido e acqua tiepida.

**FR** La table WA est disponible avec un plateau en stratifié haute pression (HPL), un plateau en verre, un plateau Slim Box en acier inoxydable et un plateau en teck. Le HPL est un matériau non toxique extrêmement résistant aux chocs, aux contraintes mécaniques, à l'humidité et à la vapeur. L'épaisseur unique en verre de protection résiste mieux aux changements de température ainsi qu'au poids, aux impacts et aux chocs. Le plateau de table est fabriqué dans un teck de grande qualité. La structure de support du plateau est fabriquée en profilés d'aluminium à revêtement poudre. Les pieds sont en aluminium moulé sous pression à revêtement poudre. Nettoyer avec un chiffon doux à l'eau chaude.



WA dining table 100 x 200 cm,  
white / HPL white  
AllIR armchairs, salt



# LIGHTING & ACCESSORIES







Lantern S, forest  
 Statue LIKA + optional set of eyes, midnight  
 Lantern M, terra + optional set of eyes, midday

### Fiber lantern S

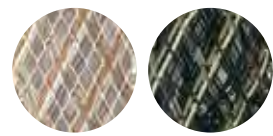

**128** cloud  
**127** forest

### Fiber lantern M



**128** cloud  
**129** terra

### Fiber lantern L



**128** cloud  
**130** rock

### Further material

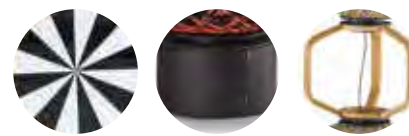

Handmade acrylic eyes, mosaic style  
 Marble base in nero marquina  
 Premium teak spacer

LANTERN S  
 Laterne S  
 Farolillo S  
 Lanterna S  
 Lanterne S  
**ø 45 cm**  
 10,1 kg 0,11 m³



093010128



ø 45

093010127



**093010**

LANTERN M  
 Laterne M  
 Farolillo M  
 Lanterna M  
 Lanterne M  
**ø 45 cm**  
 10,6 kg 0,14 m³



093020128



ø 45

093020129



**093020**

LANTERN L  
 Laterne L  
 Farolillo L  
 Lanterna L  
 Lanterne L  
**ø 45 cm**  
 11,2 kg 0,17 m³



093030128



ø 45

093030130



**093030**

LANTERN HANGING S  
 Hängende Laterne S  
 Farolillo colgante S  
 Lanterna pendente S  
 Lanterne suspendue S  
**ø 45 cm**  
 3 kg 0,09 m³



093040128



ø 45

093040127



**093040**

LANTERN HANGING M  
 Hängende Laterne M  
 Farolillo colgante M  
 Lanterna pendente M  
 Lanterne suspendue M  
**ø 45 cm**  
 3,6 kg 0,12 m³



093050128



ø 45

093050129



**093050**

LANTERN HANGING L  
 Hängende Laterne L  
 Farolillo colgante L  
 Lanterna pendente L  
 Lanterne suspendue L  
**ø 45 cm**  
 4,2 kg 0,15 m³



093060128



ø 45

093060130



**093060**

### OPTIONAL SET OF EYES

Optionales Augenset  
 Kit opcional de ojos  
 Kit occhi, opzionale  
 Kit optionnel yeux



sunrise  
 093092001



midday  
 093092002



midnight  
 093092003

**093092**





STATUE TEBU  
Statue TEBU  
Estatua TEBU  
Statua TEBU  
Statue TEBU  
**ø 45 cm**  
12,9 kg 0,19 m<sup>3</sup>  
**093100000**



STATUE LIKA  
Statue LIKA  
Estatua LIKA  
Statua LIKA  
Statue LIKA  
**ø 45 cm**  
14,1 kg 0,26 m<sup>3</sup>  
**093110000**



STATUE JAMA  
Statue JAMA  
Estatua JAMA  
Statua JAMA  
Statue JAMA  
**ø 45 cm**  
13,2 kg 0,26 m<sup>3</sup>  
**093120000**



STATUE KAFA  
Statue KAFA  
Estatua KAFA  
Statua KAFA  
Statue KAFA  
**ø 45 cm**  
13,5 kg 0,29 m<sup>3</sup>  
**093150000**



STATUE BUKA  
Statue BUKA  
Estatua BUKA  
Statua BUKA  
Statue BUKA  
**ø 45 cm**  
12,9 kg 0,19 m<sup>3</sup>  
**093130000**



STATUE TOBO  
Statue TOBO  
Estatua TOBO  
Statua TOBO  
Statue TOBO  
**ø 45 cm**  
13,9 kg 0,29 m<sup>3</sup>  
**093140000**



**EN** This lighting object is a decorative element for outdoor and indoor use and features a warm white correlated color temperature (2700 Kelvin). It has an ingress protection marking for LED module by IP64, which means it is dustproof, splashproof and therefore fully suitable for outdoor use. There are two ways of charging the LED module, by solar panel and by power adapter. Energy efficiency EEC A+. These luminaires contain builtin LED lamps. The lamps cannot be changed in the luminaires. THE OTHERS components are made with DEDON Fiber, premium teak, Italian marble and acrylic mosaic. Clean teak with warm water in which natural soap flakes have been dissolved. Custom-made compositions may be specially ordered.

**DE** Diese Leuchte ist ein dekoratives Objekt für den Innen- und Außenbereich mit einer warmweißen Farbtemperatur (2700 Kelvin). Das LED-Modul hat die Schutzklasse IP64 gegen Eindringen von Wasser und Schmutz, ist also staubdicht und spritzwassergeschützt und somit absolut geeignet für den Einsatz im Außenbereich. Aufladen lassen sich die LED-Module auf zweierlei Arten: über Solarmodule oder ein Netzkabel. Energieeffizienzklasse EED A+. Die Leuchten enthalten eingebaute LED-Lampen, die nicht ausgetauscht werden können. Die Elemente der THE OTHERS-Kollektion bestehen aus DEDON-Faser, Premium-Teak, italienischem Marmor und Acrylmosaik. Teak-Elemente mit lauwarmem Wasser reinigen, in dem natürliche Seifenflocken vollständig aufgelöst wurden. Kundenindividuelle Kombinationen sind bestellbar.

**ES** Esta lámpara es un objeto decorativo para exteriores e interiores con una temperatura de color blanco cálido (2700 Kelvin). El módulo LED posee la clase de protección IP 64, lo que significa que es a prueba de polvo y de salpicaduras y, por lo tanto, adecuado para su uso en exteriores. Eficiencia energética: IEE A+. Estas lámparas incorporan luces LED. Las luces no se pueden sustituir en las lámparas. Los elementos de THE OTHERS están elaborados con fibra DEDON, teca de primera calidad, mármol italiano y mosaico acrílico. Limpiar la teca con agua tibia después de que el jabón natural se haya disuelto. Se pueden encargar composiciones personalizadas.

**IT** Questa lampada è un oggetto decorativo per esterni e interni e sono caratterizzati da una temperatura di colore bianco caldo (2700 Kelvin). Il modulo LED è in classe di protezione IP 64, vale a dire a tenuta di polvere e protetto dall'umidità ed è pertanto idoneo per l'uso in ambiente esterno. Efficienza energetica: EEK A+. Queste lampade contengono lampadine a LED integrate. Non è possibile sostituire le lampadine all'interno delle lampade. I componenti della collezione THE OTHERS sono: fibra DEDON, teak di qualità premium, marmo italiano e mosaico acrilico. Il modo migliore per pulire il teak è usare acqua tiepida con l'aggiunta di sapone neutro che non danneggi il materiale. Combinazioni personalizzabili su richiesta.

**FR** Cette lampe est un objet de décoration destiné à un usage à l'intérieur comme à l'extérieur, avec une température de couleur blanc chaud (2700 kelvins). Le module LED est doté de la classe de protection IP 64, ce qui signifie qu'il étanche à la poussière et aux éclaboussures, et donc parfaitement adapté à un usage à l'extérieur. Le module LED se charge de 2 manières: soit via un panneau solaire, soit via un câble électrique. Efficacité énergétique: EEK A+. Ces luminaires sont avec des lampes LED intégrées, qui ne peuvent pas être remplacées. Les éléments de la collection THE OTHERS sont en fibre DEDON, en teck de première qualité, en marbre originaire d'Italie et en mosaïque acrylique. Nettoyez le teck avec de l'eau chaude dans laquelle ont été dissous des copeaux de savon naturel. Il est possible de commander des compositions personnalisées.







Floor lamp L  
Floor lamp S

## Material



Polyethylene  
off white



Premium Teak

FLOOR LAMP S  
Bodenleuchte S  
Lámpara de pie S  
Lampada da pavimento S  
Lampe sur pied S  
**ø 42 cm**  
3,2 kg 0,12 m³

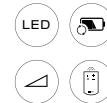
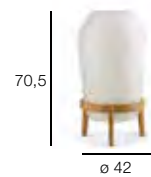

101010000

FLOOR LAMP L  
Bodenleuchte L  
Lámpara de pie L  
Lampada da pavimento L  
Lampe sur pied L  
**ø 54 cm**  
6,3 kg 0,27 m³

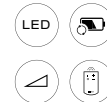

101030000

**EN** This lighting object is a decorative element for outdoor and indoor use and features a warm white correlated color temperature (2700 Kelvin). It has an ingress protection marking for LED module by IP64, which means it is dustproof, splashproof and therefore fully suitable for outdoor use. Energy efficiency eec A+. These luminaires contain builtin LED lamps. The lamps cannot be changed in the luminaires. LOON consists of rotomolded polyethylene and a premium teak base. Clean teak base with warm water in which natural soap flakes have been dissolved.

**DE** Diese Leuchte ist ein dekoratives Objekt für den Innen- und Außenbereich mit einer warmweißen Farbtemperatur (2700 Kelvin). Das LED-Modul hat die Schutzklasse IP64 gegen Eindringen von Wasser und Schmutz, ist also staubdicht und spritzwassergeschützt und somit absolut geeignet für den Einsatz im Außenbereich. Energieeffizienzklasse EEK A+. Die Leuchten enthalten eingebaute LED-Lampen, die nicht ausgetauscht werden können. LOON besteht aus im Rotationsgussverfahren gefertigtem Polyethylen mit einem Untergestell aus Teak. Das Teak-Gestell mit lauwarmem Wasser reinigen, in dem natürliche Seifenflocken vollständig aufgelöst wurden.

**ES** Esta lámpara es un objeto decorativo para exteriores e interiores con una temperatura de color blanco cálido (2700 Kelvin). El módulo LED posee la clase de protección IP 64, lo que significa que es a prueba de polvo y de salpicaduras y, por lo tanto, adecuado para su uso en exteriores. Eficiencia energética: IEE A+. Estas lámparas incorporan luces LED. Las luces no se pueden sustituir en las lámparas. LOON consiste de una base hecha en teca de primera calidad y una pantalla de polietileno rotomoldeado. Lavar con agua templada y jabón natural en copos bien disuelto.

**IT** Questa lampada è un oggetto decorativo per esterni e interni ed è caratterizzata da una temperatura di colore bianco caldo (2700 Kelvin). Il modulo LED è in classe di protezione IP 64, vale a dire a tenuta di polvere e protetto dall'umidità ed è pertanto idoneo per l'uso in ambiente esterno. Efficienza energetica: EEK A+. Queste lampade contengono lampadine a LED integrate. Non è possibile sostituire le lampadine all'interno delle lampade. LOON è una lampada in polietilene (PE) rotostampato montata su un telaio in teak. Il modo migliore per pulire il teak è usare acqua tiepida con l'aggiunta di sapone neutro che non danneggi il materiale.

**FR** Cette lampe est un objet de décoration destiné à un usage à l'intérieur comme à l'extérieur, avec une température de couleur blanc chaud (2700 kelvins). Le module LED est doté de la classe de protection IP 64, ce qui signifie qu'il étanche à la poussière et aux éclaboussures, et donc parfaitement adapté à un usage à l'extérieur. Le module LED se charge de 2 manières: soit via un panneau solaire, soit via un câble électrique. Efficacité énergétique: EEK A+. Ces luminaires sont avec des lampes LED intégrées, qui ne peuvent pas être remplacées. LOON est composé de polyéthylène rotomoulé et d'une base en teck de première qualité. Nettoyez la base en teck avec de l'eau chaude dans laquelle ont été dissous des copeaux de savon naturel.







Side table PE, incl. light

## Material



Polyethylene  
off white

STOOL / SIDE TABLE PE, INCL. LIGHT  
Hocker / Beistelltisch PE, inkl. Licht  
Asiento / Mesa auxiliar PE, lámpara incluida  
Pouf / Tavolino PE, luce inclusa  
Tabouret / Table d'appoint PE, lampe comprise  
**ø 52,5 cm**  
5,3 kg 0,12 m<sup>3</sup>



053112000

**EN** This lighting object is a decorative element for outdoor and indoor use and features a warm white correlated color temperature (2700 Kelvin). It has an ingress protection marking for LED module by IP64, which means it is dustproof, splashproof and therefore fully suitable for outdoor use. Energy efficiency eec A+. These luminaires contain built-in LED lamps. The lamps cannot be changed in the luminaires. BABYLON PE consists of rotomolded polyethylene. For more BABYLON products, please see pages 150/151 and 276.

**DE** Diese Leuchte ist ein dekoratives Objekt für den Außen- und Innenbereich mit einer warmweißen Farbtemperatur (2700 Kelvin). Das LED Modul hat die Schutzklasse IP 64, ist also staubdicht und spritzwassergeschützt und somit absolut geeignet für die Verwendung im Außenbereich. Energieeffizienz EEEK A+: Diese Leuchten enthalten eingebaute LED-Lampen. Die Lampen können in den Leuchten nicht ausgetauscht werden. BABYLON PE ist aus Rotationsguss-gefertigtem Polyethylen (PE) hergestellt. Für weitere BABYLON Produkte blättern Sie auf Seite 150/151 und 276.

**ES** Esta lámpara es un objeto decorativo para exteriores e interiores con una temperatura de color blanco cálido (2700 Kelvin). El módulo LED posee la clase de protección IP 64, lo que significa que es a prueba de polvo y de salpicaduras y, por lo tanto, adecuado para su uso en exteriores. Eficiencia energética: IEE A+. Estas lámparas incorporan luces LED. Las luces no se pueden sustituir en las lámparas. La colección BABYLON PE está fabricada de polietileno rotomoldeado. Para ver más productos de BABYLON, consulte las páginas 150/151 y 276.

**IT** Questa lampada è un oggetto decorativo per esterni e interni, caratterizzata da una temperatura di colore bianco caldo (2700 Kelvin). Il modulo LED è in classe di protezione IP 64, vale a dire a tenuta di polvere e protetto dall'umidità ed è pertanto idoneo per l'uso in ambiente esterno. Efficienza energetica: EEEK A+. Queste lampade contengono lampadine a LED integrate. Non è possibile sostituire le lampadine all'interno delle lampade. BABYLON PE è realizzato in polietilene (PE) rotostampato. Potete vedere gli altri prodotti BABYLON a pagina 150/151 e 276.

**FR** Cette lampe est un objet de décoration destiné à un usage à l'intérieur comme à l'extérieur, avec une température de couleur blanc chaud (2700 kelvins). Le module LED est doté de la classe de protection IP 64, ce qui signifie qu'il est étanche à la poussière et aux éclaboussures, et donc parfaitement adapté à un usage à l'extérieur. Le module LED se charge de 2 manières : soit via un panneau solaire, soit via un câble électrique. Efficacité énergétique : EEEK A+. Ces luminaires sont avec des lampes LED intégrées, qui ne peuvent pas être remplacées. BABYLON PE est composé de polyéthylène rotomoulé. Pour découvrir d'autres produits BABYLON, consultez les pages 150/151 et 276.





# BABYLON PLANTER

Design by HARRY-PAUL



2x Planter L

## Material



PLANTER L  
Übertopf L  
Cubretiesto L  
Portvaso L  
Cache-pot L  
ø 87 cm  
30 kg 0,76 m³

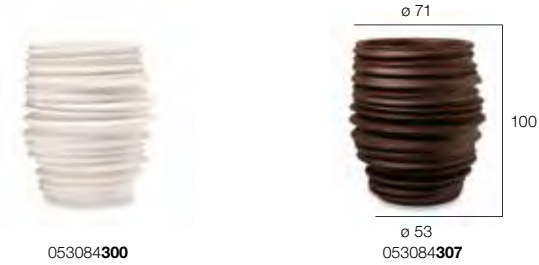

053084

053084300

053084307

INTERIOR VIEW  
Innenansicht  
Vista interior  
Vista interna  
Vue intérieur



**EN** The BABYLON Planter is a dual-walled planter the volume of which can vary depending on the size of the plant. Made of roto-moulded polyethylene (PE): 100% approved for outdoor use, easy to maintain, 100% recyclable, light yet robust at the same time.

**DE** BABYLON Planter ist ein doppelwandiger Übertopf, dessen Volumen je nach Pflanzengröße variiert werden kann. Aus Rotationsguss gefertigtem Polyethylen (PE) hergestellt: 100% Outdoor-Verwendung, einfach zu pflegen, gleichzeitig leicht und widerstandsfähig, 100% recyclingfähig.

**ES** BABYLON Planter es un macetero de pared doble cuyo volumen puede variar según el tamaño de la planta. Fabricado en polietileno rotomol-deado (PE): 100% para uso en exteriores, de fácil mantenimiento, ligero y al mismo tiempo resistente, 100% reciclable.

**IT** BABYLON Planter è un vaso a doppia parete, il cui volume può essere adattato in base alle dimensioni della pianta. Fabbricato in polietilene rotostampato: adatto al 100% ad un utilizzo in ambienti esterni, di facile manutenzione, leggero e allo stesso tempo resistente, 100% riciclabile.

**FR** BABYLON Planter est un cache-pot à double paroi dont le volume peut être adapté en fonction de la taille de la plante. En Polyéthylène (PE) rotomoulé : 100% adapté au plein air, facile d'entretien, à la fois léger et résistant. 100% recyclable.

# VID

Design by DEDON DESIGN STUDIO



Carpet FRINGES, 200 x 300 cm canvas

## Material



CARPET FRINGES  
Teppich FRINGES  
Alfombra FRINGES  
Tappeto FRINGES  
Tapis FRINGES  
200 x 300 cm



300 200

098030125



098030124

CARPET SOLID  
Teppich SOLID  
Alfombra SOLID  
Tappeto SOLID  
Tapis SOLID  
200 x 300 cm



300 200

098020125



098020124

CARPET SOLID  
Teppich SOLID  
Alfombra SOLID  
Tappeto SOLID  
Tapis SOLID  
300 x 400 cm

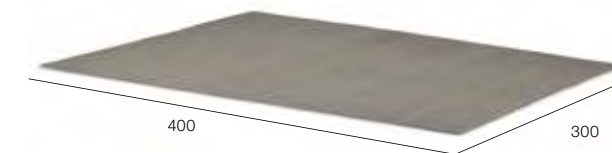

400 300

098025125

**EN** VID is handwoven and consists of 100% polypropylene. Designed and treated for outdoor use, it is UV- and weather-resistant. We recommend to lift the carpet periodically to let it dry.

**DE** VID ist handgewebt und besteht aus 100% Polypropylen. Der Teppich ist witterungsbeständig, hat eine hohe UV-Resistenz und eignet sich für den Einsatz im Außenbereich. Wir empfehlen, den Teppich regelmäßig anzuheben, um ihn vollständig zu trocknen.

**ES** VID está tejido a mano e está compuesto de 100% polipropileno. La alfombra es resistente a la intemperie, es altamente resistente a los rayos UV y es adecuada para utilizarse al aire libre. Se recomienda levantar periódicamente la alfombra para secarla completamente.

**IT** VID è tessuto a mano e composto al 100% di polipropilene. Il tappeto è resistente agli agenti atmosferici e ai raggi UV e adatto all'utilizzo all'aperto. Si raccomanda di sollevare il tappeto regolarmente per garantirne l'asciugatura completa.

**FR** Le tapis VID, 100 % polypropylène, est tissé à la main. Il résiste aux intempéries, présente une haute résistance aux UV et se prête à une utilisation à l'extérieur. Nous vous conseillons de surélever régulièrement le tapis afin qu'il sèche entièrement.



# DALA PLANTER & LANTERN

Design by STEPHEN BURKS



Planter ø 61 cm  
Planter ø 76 cm  
Lantern ø 21 cm  
Lantern ø 34 cm  
Lantern ø 41 cm

## Planter

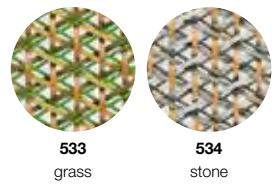

## Lantern



PLANTER S  
Übertopf S  
Cubretiesto S  
Portavaso S  
Cache-pot S  
ø 61 cm  
5 kg 0,17 m³



073050  
073050533 073050534

PLANTER M  
Übertopf M  
Cubretiesto M  
Portavaso M  
Cache-pot M  
ø 61 cm  
5 kg 0,23 m³



073052  
073052533 073052534

PLANTER L  
Übertopf L  
Cubretiesto L  
Portavaso L  
Cache-pot L  
ø 76 cm  
8 kg 0,48 m³

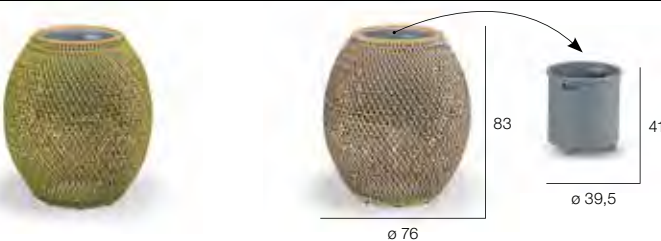

073051  
073051533 073051534

LANTERN  
Laterne  
Farolillo  
Lanterna  
Lanterne  
ø 21 cm  
1 kg 0,02 m³

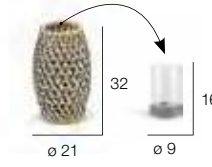

073060  
073060534

LANTERN  
Laterne  
Farolillo  
Lanterna  
Lanterne  
ø 34 cm  
2 kg 0,06 m³

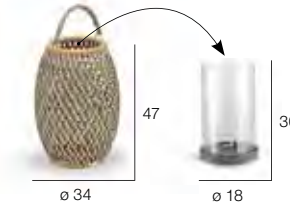

073061  
073061534

LANTERN  
Laterne  
Farolillo  
Lanterna  
Lanterne  
ø 41 cm  
2,5 kg 0,11 m³

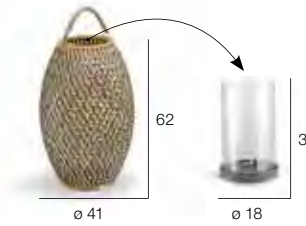

073062  
073062534

**EN** The removable inner planter consists of rotomolded polyethylene. The removable candle holder consists of a metal candle plate and a plastic tube. For the small DALA lantern (height 32 cm), use only a block **candle** with a maximum height of 8 cm and a maximum diameter of 11 cm. For the medium and large DALA lanterns (heights 47 and 62 cm), use only a block candle with a maximum height of 22 cm and a maximum diameter of 17 cm.

**DE** Der herausnehmbare innere Behälter wurde in Rotationsgusstechnik aus Polyethylen gefertigt. Der herausnehmbare Kerzenhalter besteht aus einem Kerzenteller aus Metall und einem Kerzenschutz aus Kunststoff. Die **Kerzen** sollten für die kleine DALA Laterne (Höhe 32 cm) eine Höhe von 11 cm und einen Durchmesser von 8 cm nicht überschreiten. Die Kerzen für die DALA Laternen mittlerer und großer Größe (Höhe 47 und 62 cm) sollten nicht höher als 22 cm sein und einen maximalen Durchmesser von 17 cm nicht überschreiten. Verwenden Sie bitte ausschließlich Blockkerzen.

**ES** Recipiente interior extraíble de polietileno rotomoldeado. El portavelas desmontable está compuesto por un plato metálico y un tubo plástico. Para el farolillo DALA pequeño (altura 32 cm) utilice únicamente una **vela** con una altura máxima de 11 cm y un diámetro máximo de 8 cm. Para los farolillos DALA mediano y grande (altura 47 y 62 cm) utilice únicamente una vela con una altura máxima de 22 cm y un diámetro máximo de 17 cm.

**IT** Il portalampada amovibile si compone di un piatto metallico e di un cilindro in plastic. Per la lanterna DALA piccola (altezza 32 cm), utilizzare esclusivamente **candele** cilindriche con altezza massima di 11 cm e diametro massimo di 8 cm. Per le lanterne DALA medie e grandi (altezza 47 e 62 cm), utilizzare esclusivamente candele cilindriche con altezza massima di 22 cm e diametro massimo di 17 cm.

**FR** L'intérieur amovible du cache pot est en polyéthylène rotomoulé. Le bougeoir amovible est composé d'une soucoupe en métal et d'un tube en plastique. Pour la lanterne DALA (32 cm de hauteur), utiliser une seule **bougie** mesurant 11 cm de hauteur max. et 8 cm de diamètre max. Pour les lanternes DALA de moyenne et grande taille (47 et 62 cm de hauteur), utiliser une bougie mesurant 22 cm de hauteur max. et 17 cm de diamètre max. N'utiliser que des bougies pleines

HANGER FOR LANTERN Ø 21 CM  
Aufhängung für Laterne ø 21 cm  
Elemento de suspensión para el farolillo ø 21 cm  
Supporto per lanterna ø 21 cm  
Accessoire de suspension pour lanterne ø 21 cm



073091000

HANGER FOR LANTERN Ø 34 CM AND Ø 41 CM  
Aufhängung für Laterne ø 34 cm und ø 41 cm  
Elemento de suspensión para el farolillo ø 34 cm y ø 41 cm  
Supporto per lanterna ø 34 cm e ø 41 cm  
Accessoire de suspension pour lanterne ø 34 cm et ø 41 cm



073092000



# PARASOL

Design by DEDON DESIGN STUDIO



PARASOL Hexagon 260 x 287 cm  
SEASHELL Lounge chair  
SEASHELL Footstool

## Hexagon / Square

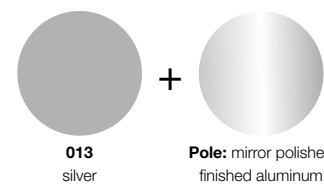
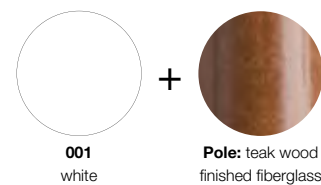

## Square Cantilever

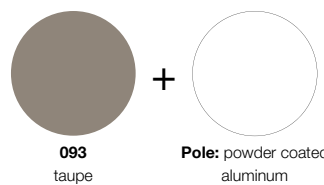
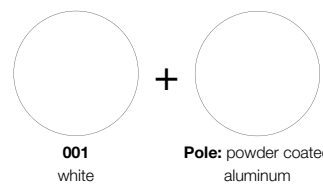

HEXAGON  
Sechseck  
Hexágono  
Esagono  
Hexagone  
**260 x 287 cm**  
11 kg

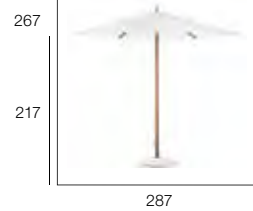

BASE  
Fuß  
Pie  
Base  
Socle  
49 kg



included  
00058097000

058091

058091001

058095001

058095

00058097000

SQUARE  
Quadrat  
Cuadrado  
Quadrato  
Carré  
**260 x 260 cm**  
11 kg

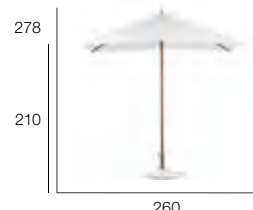

BASE  
Fuß  
Pie  
Base  
Socle  
49 kg



included  
00058096000

058092

058092001

058095001

058095

00058096000

HEXAGON  
Sechseck  
Hexágono  
Esagono  
Hexagone  
**260 x 287 cm**  
11 kg

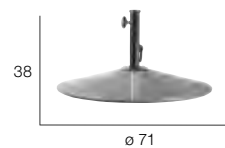
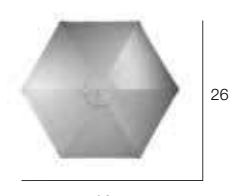
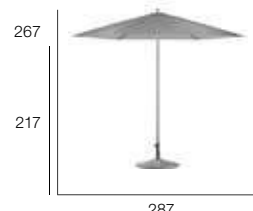

BASE  
Fuß  
Pie  
Base  
Socle  
49 kg



included  
00058097000

058089

058089013

058095013

058095

00058097000

SQUARE  
Quadrat  
Cuadrado  
Quadrato  
Carré  
**260 x 260 cm**  
11 kg

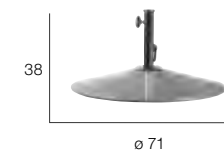
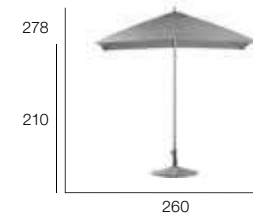

BASE  
Fuß  
Pie  
Base  
Socle  
49 kg



included  
00058096000

058090

058090013

058095013

058095

00058096000

**EN** The base consists of a concrete-filled, powder-coated aluminum shell. The canopy for the white parasol is composed out of WeatherMax® fabric while the pole and battens are composed out of fiberglass which has the warm look of teak wood. The canopy for the silver parasol is composed out of a coated fabric by Ferrari Stamoid®, which was developed specially for marine applications and sun protection. The pole and battens are composed out of a mirror-polished aluminum. All fasteners are marine-grade stainless steel.

**DE** Der Fuß besteht aus einem betongefüllten, pulverbeschichteten Aluminiumgehäuse. Bei der weißen Ausführung besteht der Schirm aus WeatherMax®-Stoff. Rohr und Speichen bestehen aus Glasfaser in warmer Teakholz-Optik. Bei der silberfarbenen Ausführung besteht der Schirm aus einem beschichteten Stoff von Ferrari Stamoid®, entwickelt für den Einsatz im Schiffsbereich und zur Beschattung. Rohr und Speichen bestehen aus spiegelpoliertem Aluminium. Alle Beschläge bestehen aus rostfreiem Stahl (schiffbauliche „marine-grade“ Qualität).

**ES** La base está compuesta por un armazón de aluminio relleno de cemento y revestido con pintura poliéster en polvo. En la versión blanca, la capota está hecha con tejido WeatherMax® y el poste y las varillas son de fibra de vidrio con el cálido aspecto de la madera de teca. En la versión gris, la capota está hecha con un tejido recubierto Ferrari Stamoid® que ha sido desarrollado para aplicaciones marinas y para ofrecer un alto nivel de protección solar, mientras que el poste y las varillas son de aluminio brillante pulido. Todos los elementos de fijación son de acero inoxidable marino.

**IT** La base consiste in un guscio di alluminio verniciato a polvere con un'anima di calcestruzzo. Per la versione color bianco l'ombrellone è in tessuto WeatherMax® con l'asta e i tiranti in fibra di vetro rivestita da un colore con calda finitura teak. Per la versione argento, l'ombrellone è in tessuto verniciato prodotto da Ferrari Stamoid®, appositamente studiato per resistere alle aggressioni degli ambienti marini e per la protezione solare, con l'asta e i tiranti in alluminio lucidato a specchio. Tutte le chiusure sono in acciaio inossidabile resistente alla corrosione dell'acqua marina.

**FR** Le socle est réalisé à partir d'une coque en aluminium remplie de béton et thermolaqué. Pour le modèle blanc, la toile est en tissu WeatherMax® et le manche et les lattes sont en fibre de verre imitation bois de teck. Pour le modèle argent, la toile est en tissu Ferrari Stamoid® ; conçus pour l'utilisation en mer et pour protéger du soleil, le manche et les lattes sont en aluminium poli en miroir. Toutes les attaches sont en acier inoxydable de qualité marine et résistant à l'abrasion.

## SQUARE CANTILEVER

Freiarmschirm  
Parasol cantilever  
Ombrellone a braccio laterale  
Cantilever parasol  
**305 x 305 cm**  
20 kg



included  
00058071000

058071

058071001

058071093

00058071000

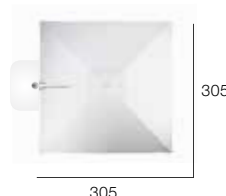

BASE  
Fuß  
Pie  
Base  
Socle  
188 kg

058075001

**EN** The base consists of a steel frame that holds four steel "pie pieces" and is covered with a powder-coated aluminum sheet. The canopy consists of WeatherMax® fabric. Pole and battens consist of powder-coated aluminum. All fasteners consist of marine-grade stainless steel. Opening and closing of the parasol is assisted by pneumatic springs.

**DE** Der Fuß besteht aus einer Grundplatte aus galvanisiertem Stahl mit vier Stahlgewichten, integriert in einer pulverbeschichteten Aluminiumhülle. Der Schirm besteht aus WeatherMax®-Stoff. Rohr und Speichen bestehen aus pulverbeschichtetem Aluminium. Alle Beschläge bestehen aus rostfreiem Stahl (schiffbauliche „marine-grade“ Qualität). Das Öffnen und Schließen des Schirms wird durch eine Gasdruckfeder unterstützt.

**ES** La base de la capota está formada por un marco de acero que sujeta cuatro varillas radiales y está recubierta por una lámina de aluminio pintado con poliéster en polvo. La capota es de tejido WeatherMax®. El poste y las varillas son también de aluminio revestidas de pintura poliéster en polvo. Todos los elementos de fijación son de acero inoxidable marino. Las acciones de abrir y cerrar el parasol están asistidas por resortes neumáticos.

**IT** La base è formata da un piatto in acciaio galvanizzato che sostiene quattro elementi dello stesso metallo è ricoperta da uno strato di alluminio verniciato a polvere. L'ombrellone è in tessuto WeatherMax®. L'asta e i tiranti sono in alluminio verniciato a polvere. Tutte le chiusure sono in acciaio inossidabile resistente alla corrosione dell'acqua marina. L'apertura e la chiusura dell'ombrellone sono facilitate dal pistone pneumatico.

**FR** Le socle est réalisé en plusieurs parties; d'une structure et de quatre lests en acier galvanisé, le tout recouvert d'une épaisse feuille d'aluminium thermolaquée. La toile est en tissu WeatherMax®. Le mât et les lattes sont en aluminium thermolaqués. Toutes les attaches sont en acier inoxydable de qualité marine et résistant à l'abrasion. Le ressort pneumatique permet d'ouvrir et de fermer le parasol en toute facilité.



# INFORMATION





# WARRANTY

## EN 5-YEAR WARRANTY

DEDON offers a five-year warranty against any manufacturing defects during normal use and maintenance. Valid for retail customers only, this warranty applies to all DEDON woven furniture that is manufactured solely from the DEDON fiber and aluminum frame. All other DEDON products are subject to a two-year warranty.

## DE 5 JAHRE GARANTIE

Für Endverbraucher wird eine 5-jährige Garantie gegen jegliche Fertigungsfehler bei normaler Verwendung und Pflege gewährt. Dies gilt für DEDON Flechtmöbel, die ausschließlich aus der DEDON Faser und aus Aluminiumrahmen hergestellt werden. Für alle weiteren DEDON Produkte gelten 2 Jahre Gewährleistung.

## ES AÑOS DE GARANTÍA

DEDON ofrece una garantía de cinco años a los consumidores finales contra cualquier defecto de fabricación bajo condiciones de uso y conservación normales. Esto se aplica a los muebles tejidos de DEDON fabricados exclusivamente de fibras DEDON y bastidores de aluminio. Para todos los demás productos ofrecemos una garantía de dos años.

## IT 5 ANNI DI GARANZIA

Si assicura una garanzia di 5 anni contro i difetti di produzione, a fronte di un uso e di una manutenzione corretta. La garanzia si applica ai mobili intrecciati DEDON che si compongono esclusivamente di fibra DEDON e telaio in alluminio. Per tutti gli altri prodotti DEDON si applica una garanzia di 2 anni.

## FR 5 ANS DE GARANTIE

Le consommateur final bénéficie d'une garantie de cinq ans contre tout vice de production. Cette garantie est accordée dans le cadre d'une utilisation et d'un entretien normaux. Celle-ci s'applique à tous les meubles en tissu qui sont fabriqués exclusivement en fibre DEDON et avec un cadre en aluminium. Pour tous les autres produits DEDON, la garantie est de deux ans.



# COPYRIGHT

## EN INTELLECTUAL PROPERTY RIGHTS AND COPYRIGHT

The DEDON Collections have been exclusively designed by our company or developed for us by designers. All designs are registered. DEDON GmbH holds the copyrights for all products. All products carry the "DEDON" label. Our trademark is protected by law. Any infringement of our rights will be prosecuted.

Beyond that, the following premium materials have been utilized:

- Batyline® is a registered trademark of The Serge Ferrari SA, France
- Ferrari Stamoid® is a registered trademark of The Serge Ferrari Group, France
- Monolite Ipergres® is a registered trademark of Laboratorio Pesaro S.r.l., Italy
- Teflon® is a registered trademark of E. I. du Pont de Nemours and Company, USA
- WeatherMax® is a registered trademark of Safety Components Fabric Technologies, Inc., USA
- Tempotest® is a registered trademark of Para´S.P.A., Italy
- RESOPAL® is a is a registered trademark of Wilsonart Engineered Surfaces, USA
- Sunbrella® is a registered trademark of Glen Raven, Inc., USA

## DE GEWERBLICHE SCHUTZRECHTE UND URHEBERRECHT

Alle DEDON Kollektionen wurden in unserem Unternehmen designt oder wurden exklusiv von Designern für uns entwickelt. Die Designs sind als eingetragene Geschmacksmuster geschützt. Die urheberrechtlichen Nutzungsrechte für alle Produkte liegen bei der DEDON GmbH. Alle Erzeugnisse sind mit unserem Markenzeichen „DEDON“ gekennzeichnet. Unser Markenzeichen ist gesetzlich geschützt. Jeder Verstoß gegen unsere Rechte wird von uns verfolgt.

Folgende Premiummaterialien werden darüber hinaus eingesetzt:

- Batyline® ist eine eingetragene Marke der Firma The Serge Ferrari SA, Frankreich
- Ferrari Stamoid® ist eine eingetragene Marke der Firma The Serge Ferrari SA, Frankreich
- Monolite Ipergres® ist eine eingetragene Marke der Firma Laboratorio Pesaro S.r.l., Italien
- Teflon® ist eine eingetragene Marke der Firma E. I. du Pont de Nemours and Company, USA
- WeatherMax® ist eine eingetragene Marke der Firma Safety Components Fabric Technologies, Inc., USA
- Tempotest® ist eine eingetragene Marke der Firma Para´S.P.A., Italien
- RESOPAL® ist eine eingetragene Marke der Firma Wilsonart Engineered Surfaces, USA
- Sunbrella® ist eine eingetragene Marke der Firma Glen Raven, Inc., USA

## ES PROPIEDAD INDUSTRIAL Y DERECHOS DE AUTOR

Las colecciones DEDON han sido diseñadas por nuestra empresa o desarrolladas en exclusiva para nosotros por diseñadores. Los diseños gozan de la protección de diseños registrados. DEDON GmbH mantiene los derechos de autor sobre todos los productos. Los artículos y productos llevan la marca "DEDON", nuestra marca protegida por ley. Cualquier infracción contra nuestros derechos será perseguida judicialmente.

Se utilizan además los siguientes materiales premium:

- Batyline® es una marca registrada de The Serge Ferrari SA, Francia
- Ferrari Stamoid® es una marca registrada de The Serge Ferrari Group, Francia
- Monolite Ipergres® es una marca registrada de Laboratorio Pesaro S.r.l., Italia
- Teflon® es una marca registrada de E. I. du Pont de Nemours and Company, Estados Unidos
- WeatherMax® es una marca registrada de Safety Components Fabric Technologies, Inc., Estados Unidos
- Tempotest® es una marca registrada de Para´S.P.A., Italia
- RESOPAL® es una marca registrada de Wilsonart Engineered Surfaces, USA
- Sunbrella® es una marca registrada de Glen Raven, Inc., USA

## IT PROPRIETÀ INTELLETTUALE E COPYRIGHT

Le collezioni DEDON sono state disegnate esclusivamente dalla nostra azienda o sono state sviluppate per noi dai nostri designer. Tutti i modelli sono registrati. DEDON GmbH detiene il copyright di ogni prodotto. Tutti i prodotti recano l'etichetta "DEDON". Il nostro marchio è protetto dalla legge. Qualsiasi violazione dei nostri diritti verrà perseguita.

Vengono inoltre utilizzati i seguenti materiali di alta qualità:

- Batyline® è un marchio registrato di The Serge Ferrari SA, Francia
- Ferrari Stamoid® è un marchio registrato di The Serge Ferrari SA, Francia
- Monolite Ipergres® è un marchio registrato di Laboratorio Pesaro S.r.l, Italia
- Teflon® è un marchio registrato di E. I. du Pont de Nemours and Company, USA
- WeatherMax® è un marchio registrato di Safety Components Fabric Technologies, Inc., USA
- Tempotest® è un marchio registrato di Para´S.P.A., Italia
- RESOPAL® è un marchio registrato di Wilsonart Engineered Surfaces, USA
- Sunbrella® è un marchio registrato di Glen Raven, Inc., USA

## FR MODÈLE ET DROITS D'AUTEUR

Toutes les collections DEDON ont été exclusivement conçues par nos soins ou ont été développées pour nous par des designers. Les modèles ont été déposés. DEDON GmbH détient les droits de propriété intellectuelle pour tous ses produits. Tous les produits portent la marque « DEDON ». Notre marque déposée est protégée par la loi. Toute violation de nos droits donnera lieu à une action en justice.

Les matériaux premium suivants sont également utilisés :

- Batyline® est une marque déposée de The Serge Ferrari SA, France
- Ferrari Stamoid® est une marque déposée de The Serge Ferrari SA, France
- Monolite Ipergres® est une marque déposée de Laboratorio Pesaro S.r.l., Italie
- Teflon® est une marque déposée de E. I. du Pont de Nemours and Company, USA
- WeatherMax® est une marque déposée de Safety Components Fabric Technologies, Inc., USA
- Tempotest® est une marque déposée de S.P.A., Italie
- RESOPAL® est une marque déposée de Wilsonart Engineered Surfaces, USA
- Sunbrella® est une marque déposée de Glen Raven, Inc., USA



# CAPTION

<b>"Set:"</b>	<b>For tables, item numbers noted with "Set" include the table and corresponding tabletop.</b>
"Set:."	Artikelnummern für Tische, die mit dem Zusatz "Set" gekennzeichnet sind, beziehen sich sowohl auf den Tisch als auch auf die jeweilige Tischplatte.
"Set:."	Para las mesas, los números de artículos que llevan anotado "Set" incluyen la mesa y su correspondiente tablero.
"Set:."	Nel caso dei tavoli, i numeri articolo contrassegnati con "Set" includono sia il tavolo che il piano tavolo corrispondente.
"Set:."	Concernant les tables, les numéros d'articles comportant le terme « set » incluent la table et le dessus de table correspondant.
<b>Variations</b>	<b>We are not liable for variations in color, weight or dimensions, since such variations are typical of handmade furniture. Some of the fabrics shown in pictures of our furniture may be discontinued.</b>
Abweichungen	Für Farben, Maße und Gewichte können wir keine Haftung übernehmen, da Abweichungen bedingt durch Handarbeit möglich sind. Manche Stoffe, die in unseren Abbildungen zu sehen sind, sind ggf. nicht mehr verfügbar.
Variaciones	No nos hacemos responsables de ninguna discordancia en cuanto al color, peso o tamaño, ya que las variaciones de este tipo son habituales en muebles fabricados a mano. Algunos de los tejidos de tapicería que aparecen en las fotografías podrían no estar disponibles.
Variazioni	Non ci assumiamo alcuna responsabilità per variazioni di colore, peso o dimensioni, poiché tali variazioni sono caratteristiche dei mobili realizzati a mano. Alcuni tessuti di rivestimento mostrati nelle immagini potrebbero essere fuori produzione.
Variations	Nous ne pouvons être tenus responsables des variations de couleur, de poids ou de dimensions, car des variations peuvent se produire dans des meubles fabriqués à la main. Quelques tissus de revêtement présentés sur nos images peuvent différer.
<b>Volume</b>	<b>The stated volume does not include packaging.</b>
Volumen	Das angegebene Volumen beinhaltet keine Verpackung.
Volumen	El volumen indicado no incluye el embalaje.
Volume	Il volume riportato non è comprensivo di imballaggio.
Volume	Le volume indiqué ne comprend pas l'emballage.
<b>Weight</b>	<b>The stated weight of a furniture item does not include cushions and may vary according to fiber options. When multiple tabletops are available, a table's stated weight excludes the weight of the tabletop options, which are given separately.</b>
Gewicht	Die Angaben zu dem Gewicht eines Möbelstücks verstehen sich exklusive Kissen und können aufgrund von unterschiedlichen Faserausführungen variieren. Stehen mehrere Tischplatten zur Auswahl, so sind die Angaben zu dem Gewicht des Tisches exklusive der Tischplatten. Das Gewicht der Tischplatten wird in diesem Fall separat aufgeführt.
Peso	El peso publicado de un artículo de muebles no incluye los cojines y puede variar de acuerdo a las fibras seleccionadas. Si hay disponibles diversos tableros de mesa, el peso dado de la mesa no incluye el peso de las opciones de tablero; este se ofrece aparte.
Peso	Il peso dei mobili indicato non include i cuscini e può variare a seconda del tipo di fibra. In caso siano disponibili più piani tavolo, il peso del tavolo non include il peso dei piani tavolo, il quale viene indicato separatamente.
Poids	Le poids indiqué pour un meuble ne comprend pas les coussins et peut varier selon la fibre choisie. Lorsque différents plateaux de table sont disponibles, le poids indiqué pour une table ne comprend pas celui du plateau choisi : celui-ci est indiqué séparément.

# IMPRINT

**Photography** Alexandre Chaplier, Christophe Dugied, Andreas Franke, Oliver Helbig, Rainer Hosch, Gerhardt Kellermann, Katharina Lux, Moritz Peters, Andreas Pletz, Tom Seelbach

**Production & Execution** Cornelia Drews, Julia Läng

**Product Documentation** Julia Brunnberg, Sybille Korn

**Graphic Design** Tobias Fuchs, Martin de la Vega, David Tipton

**Copy** Alex Marashian

**Digital Imaging** Hanse Repro

**Print** Beisner Druck

"DEDON WHOLEHEARTEDLY THANKS ALL OUR TEAM MEMBERS, CONTRIBUTORS AND FRIENDS AROUND THE WORLD FOR THEIR ENTHUSIASM, GOOD SPIRIT AND TIRELESS SUPPORT ON THIS AND EVERY PROJECT."

© 2018 DEDON GmbH, Germany. The photographs featured in our catalogs and on our website are protected by United States and international copyright laws and may not be reproduced without the express written permission of DEDON GmbH or DEDON, Inc.

Photographs of products appearing to be suspended in space, in an unnatural recreational manner or over water may be simulations created by professionals. Do not attempt to recreate these applications on your own.

# FURNITURE

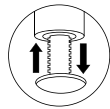

**The furniture is fitted with sliding mechanisms for height adjustment.**

Das Möbel ist mit höhenverstellbaren Gleitern ausgestattet.

El mueble lleva tapa-final regulable para ajustar la altura.

Mobile provvisto di piedini regolabili in altezza.

Le meuble est équipé de patins réglables en hauteur.



**Includes a piece for securely connecting sections.**

Inklusive Verbindungsstück "Connector" zur sicheren Verbindung einzelner Module.

Está incluido un "conector" para conectar los módulos de forma segura.

Include un 'connettore' per unire le varie sezioni in modo sicuro.

Comprend un "connecteur" pour relier les éléments de manière sécurisée.

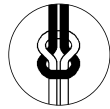

**The cushions come equipped with a cushion holder to keep them from sliding.**

Damit die Kissen nicht verrutschen, werden sie mit einem Kissenhalter geliefert.

Los cojines vienen equipados con un soporte de fijación para evitar que se deslicen.

I cuscini sono dotati di un apposito supporto che impedisce loro di scivolare.

Un support de coussin est fourni avec chaque coussin pour les empêcher de glisser.

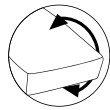

**The seat cushion on this item may be flipped.**

Das Sitzkissen dieses Möbels ist wendbar.

El cojín de este asiento es reversible.

Il cuscino della seduta di questo mobile è double face.

Le coussin de cet article est réversible.

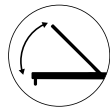

**The backrest mechanism allows the stepless adjustment of your furniture thanks to a gas spring. Please review the instruction manual!**

Der Mechanismus der Rückenlehne erlaubt aufgrund der Verwendung einer Gasdruckfeder das stufenlose Verstellen des Möbels. Bitte beachten Sie die mitgelieferte Gebrauchsanleitung!

El mecanismo del respaldo permite ajustar el mueble en progresión continua.

¡Por favor, tenga en cuenta las instrucciones de uso suministradas con el producto!

Il meccanismo permette un'inclinazione progressiva dello schienale.

Seguire le istruzioni incluse nel manuale!

Le mécanisme du dossier permet un réglage progressif du meuble grâce à un ressort à gaz.

Veuillez consulter le mode d'emploi fourni !

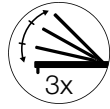

**This item is available with a hook-catching mechanism. See icon for number of hooks.**

Dieser Artikel ist mit Stufenverstellung erhältlich. Das Symbol zeigt jeweils die Anzahl der Stufen.

Este artículo dispone de un mecanismo de ajuste de altura. El icono muestra el número de ajustes.

Questo articolo è disponibile con un meccanismo di regolazione a ganci. Il simbolo indica il rispettivo numero di ganci.

Cet article est disponible avec un mécanisme de réglage du niveau d'inclinaison. Le pictogramme montre le nombre de niveaux.



**The furniture is fitted with wheels.**

Das Möbel ist mit Rollen ausgestattet.

El mueble lleva ruedas.

Mobile provvisto di ruote.

Le meuble est équipé de roulettes.



**This item is stackable.**

Das Möbel ist stapelbar.

Este artículo es apilable.

Questo articolo è impilabile.

Le meuble est empilable.



**Rotatable by 360°.**

Um 360° drehbar.

Gira 360°.

Ruota su se stesso di 360°.

Rotatif à 360°.



**This item rocks.**

Artikel mit Schaukelfunktion.

Este artículo se balancea.

Questo articolo dondola.

Le meuble se balance.

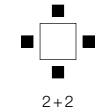

**The recommended number of chairs is only for the collection represented and does not necessarily apply to chairs of another collection.**

Die empfohlene Anzahl gilt allein für die Stühle dieser Kollektion und kann nicht auf kollektionsfremde Stühle übertragen werden.

El número recomendado sólo se aplica a las sillas de esta colección y no se puede trasladar a sillas de otras colecciones.

Il numero consigliato si riferisce unicamente alle sedie di questa collezione, non è valido per sedie di altre collezioni.

Le nombre recommandé ne vaut que pour les chaises de cette collection et ne peut pas être appliqué aux chaises d'autres collections.



**A protective cover is available for this item.**

Für dieses Möbel ist eine schützende Husse erhältlich.

Existe la opción de una funda protectora para este mueble.

Per questi arredi è disponibile una housse di protezione.

Une housse de protection est disponible pour ce meuble.

# LIGHTING

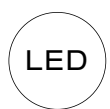

**The product is fitted with an LED lighting module.**

Das Produkt ist mit einem LED Modul ausgestattet.

Este producto viene equipado con un módulo de iluminación LED.

Il prodotto è dotato di un modulo LED.

Ce produit comporte un module d'éclairage LED.



**There are two ways of charging the LED module, by solar panel and by power adapter.**

Zwei Optionen zum Aufladen des LED Moduls: Solarpanel oder Ladekabel.

Dos opciones para cargar el módulo LED: Panel solar o cable de carga.

Due opzioni per ricaricare il modulo LED: pannello solare o cavo elettrico.

Deux options pour charger le module LED : panneau solaire ou câble de chargement.



**There is one way of charging the LED module by power adapter.**

Das LED Modul wird mit einem Ladekabel aufgeladen.

El Módulo LED se carga solo a través del cable de carga.

Il modulo LED è caricabile tramite un adattatore di corrente.

Seul le câble de chargement permet de charger le module LED.

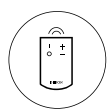

**Remote Control: To switch on the light, use the remote control or the button on the bottom of the LED module.**

Fernbedienung: Sie können entweder die Fernbedienung verwenden, um die Leuchten einzuschalten, oder die Taste an dem LED Modul.

Control remoto: Para encender las luces puede utilizar el control remoto o pulsar la tecla del módulo LED.

Telecomando: Per accendere la luce potete usare il telecomando o il tasto sul modulo LED.

Télécommande : Vous pouvez vous servir soit de la télécommande, soit de la touche située sur le module LED pour allumer les lampes.

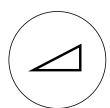

**In addition to the on/off button, the remote control has a +/- function for adjusting the dimmer (8 steps).**

Die Fernbedienung hat eine An- und eine Austaste, sowie eine + und eine - Taste für die Dimm-Funktion (8 Stufen).

El control remoto tiene un botón de encendido y de apagado y un botón de + y - para la función de atenuación.

Il telecomando ha un tasto di accensione e spegnimento (on/off) e un tasto + e un tasto - per variare l'intensità luminosa.

La télécommande comporte une touche Marche et une touche Arrêt, ainsi qu'une touche + et une touche - pour adapter l'intensité lumineuse.





# FIBER

## EN DEDON FIBER

Researched, developed, manufactured and quality-tested at our production facilities in Northern Germany, DEDON fiber (HDPE) is unrivaled for its durability, weather-fastness and of luxuriousness of color, texture and touch. Strong enough to withstand the harshest conditions yet supple enough to be woven into artful patterns by our master weavers, it has revolutionized outdoor furniture.

Because DEDON produces its fiber entirely in house, we are able to work with our world-renowned designers to develop unique colors, textures and profiles. Our specialists monitor every new fiber we create, checking for resistance to UV-rays, salt water, pool water and extremes of temperature. The final product is non-toxic, non-polluting and fully recyclable. It is maintenance-free, easy to clean and recommended for indoor and outdoor use.

## DE DIE DEDON FASER

Die DEDON-Faser (HDPE) wird in unseren hochmodernen Produktionsstätten in Norddeutschland erforscht, entwickelt, hergestellt und auf ihre Qualität getestet. Sie ist konkurrenzlos in ihrer Strapazierfähigkeit und Wetterfestigkeit und zeichnet sich durch luxuriöse Farben, feine Textur und besondere Haptik aus. Die Faser hat den Bereich Outdoor-Möbel revolutioniert, denn sie ist stark genug, den härtesten Bedingungen zu trotzen und gleichzeitig so biegsam, dass unsere Flechtkünstler kunstvolle Muster aus ihr fertigen können.

Dadurch, dass wir bei DEDON unsere Fasern komplett im eigenen Hause fertigen lassen, können wir gemeinsam mit unseren Designern von Weiruf Fasern mit einzigartigen Farben, Oberflächen und Faserprofilen entwickeln.

Jede neu entwickelte Faser wird von unseren Experten auf ihre Beständigkeit gegen UV-Strahlung, Salz- und Chlorwasser und extreme Temperaturen geprüft. Das fertige Produkt ist schadstofffrei, umweltfreundlich und voll recycelbar, wartungsfrei, leicht zu reinigen sowie für den Einsatz im Innen- und Außenbereich geeignet.

## ES FIBRA DEDON

Investigada, desarrollada, fabricada y de calidad probada en nuestras instalaciones de producción del norte de Alemania. La fibra DEDON (HDPE) es inigualable por su durabilidad y resistencia a las condiciones climáticas, así como por el lujo de colores, texturas y tactos. Lo suficientemente fuerte para resistir a las condiciones más duras, pero lo bastante flexible para ser trenzada por nuestros maestros tejedores, que crean artísticos patrones, esta fibra ha revolucionado el mobiliario de exterior.

DEDON fabrica sus fibras en sus instalaciones, por lo que somos capaces de trabajar con nuestros diseñadores de renombre internacional para desarrollar colores, texturas y perfiles únicos. Nuestros especialistas supervisan cada nueva fibra que creamos, comprobando su resistencia a los rayos UV, al agua salobre, al agua de piscina y a las temperaturas extremas. El producto final no contiene sustancias nocivas, no es contaminante y es totalmente reciclable. No requiere mantenimiento, es fácil de limpiar y es recomendable para utilizar tanto en exteriores como en interiores.

## IT LA FIBRA DEDON

Studiata, sviluppata, prodotta e sottoposta a test di qualità nei nostri stabilimenti di produzione con sede nella Germania del nord, la fibra DEDON (in HDPE) non teme confronti in quanto a durata, resistenza alle intemperie, ricchezza di colori, tessuti, piacevolezza al tatto. Robusta a sufficienza per resistere alle condizioni atmosferiche più rigorose, ma abbastanza soffice da poter essere intrecciata in motivi artistici dai nostri mastri tessitori, la fibra ha rivoluzionato l'arredamento outdoor.

Grazie al fatto che l'intera produzione della fibra DEDON avviene nei nostri stabilimenti, siamo in grado di lavorare insieme a designer di fama internazionale per sviluppare colori, tessuti e profili che riflettano l'anima delle loro collezioni. I nostri specialisti controllano ogni nuova fibra che creiamo, verificandone la resistenza ai raggi UV, all'acqua salata, all'acqua clorata e alle temperature estreme. Il prodotto che ne risulta è atossico, non inquina ed è completamente riciclabile. Non richiede manutenzione, è facile da pulire e ideale da usare sia in ambienti interni che esterni."

## FR FIBRE DEDON

Étudiée, développée, fabriquée et testée dans nos sites de production du nord de l'Allemagne, la fibre DEDON (HDPE) possède une solidité et une résistance aux intempéries inégalées et se démarque de ses concurrents par des couleurs luxueuses, une texture délicate et une agréable sensation au toucher. Suffisamment solide pour résister aux conditions les plus extrêmes et pourtant tellement souple pour le tressage d'élégants modèles par nos maîtres-tisserands, la fibre a révolutionné l'univers du mobilier d'extérieur.

La production exclusivement interne de notre fibre DEDON nous permet de collaborer avec des designers connus dans le monde entier pour concevoir et développer des couleurs, des textures et des profils uniques. Nos experts examinent chaque nouvelle fibre élaborée, vérifiant la résistance aux rayons ultraviolets, à l'eau salée et chlorée et aux températures extrêmes. Le produit fini est non toxique, non polluant et entièrement recyclable. Il ne nécessite en outre aucun entretien, est facile à nettoyer et est recommandé pour l'intérieur et l'extérieur.



# TABLETOPS

## EN THE FINISHING TOUCHES FOR YOUR TABLE

From glass to teak, aluminum to HPL, DEDON offers a wide range of tabletop materials. These innovative solutions not only integrate with the design concepts of the various collections but also meet the top-quality standards DEDON insists upon for all of its outdoor furniture.

- **SINGLE-LAYER TEMPERED GLASS**  
Offers increased resistance to temperature changes as well as excellent resistance to bending, impact and shock. To clean a glass tabletop, use a soft cloth, warm water and a gentle cleanser if needed.

- **HIGH PRESSURE LAMINATE (HPL)**  
A non-toxic material that is highly resistant to impact, mechanical stress, moisture and steam. To clean an HPL tabletop, use a soft cloth, warm water and a gentle cleanser if needed.

- **POWDER-COATED METAL**  
The metal sheets are covered with a highly resistant powder-coating, giving the tabletop unbeatable durability and outdoor performance. Clean with a soft cloth and warm water.

- **NATURAL-FINISH TEAK**  
Consisting of beautiful slow-growth premium teak sourced from sustainable plantations, the tabletop is rich with natural tannin oils, offering great durability in extreme weather conditions. Wash using warm water in which natural soap flakes have been dissolved.

- **MINERAL-COMPOSITE TABLETOP**  
Produced especially for DEDON, the tabletops are pore-free, highly resistant to frost, UV-rays and scuffing, and twice as strong as glass. Clean with soft cloth and warm water.

## DE DER LETZTE SCHLIFF FÜR IHREN TISCH

Ob Glas, Teak, Aluminium oder HPL, DEDON bietet eine große Palette verschiedener Materialien für Tischplatten. Diese innovativen Werkstoffe passen nicht nur genau zum jeweiligen Designkonzept der verschiedenen Kollektionen, sie erfüllen auch die höchsten Qualitätsansprüche, die DEDON bei der Verwendung für Gartenmöbel fordert.

- **GLAS**  
Das Einscheiben-Sicherheitsglas verfügt über eine verbesserte Temperaturwechselbeständigkeit und weist eine sehr gute Biege-, Schlag- und Stoßfestigkeit auf. Zur Reinigung der Tischplatte eignen sich ein weiches Tuch, warmes Wasser und bei Bedarf ein sanftes Reinigungsmittel.

- **HIGH-PRESSURE-LAMINATE (HPL)**  
HPL ist ein ungiftiges Material, das sich durch hohe Stoßfestigkeit und extreme Widerstandskraft gegen mechanische Einwirkungen, Feuchtigkeit und Dampf auszeichnet. Zur Reinigung der Tischplatte eignen sich ein weiches Tuch, warmes Wasser und bei Bedarf ein sanftes Reinigungsmittel.

- **PULVERBESCHICHTETES METALL**  
Die Metallplatten sind mit einer hochresistenten Pulverbeschichtung versehen. Diese Tischplatten zeichnen sich durch besondere Haltbarkeit und Wetterfestigkeit aus. Einfach mit einem weichen Tuch und warmem Wasser zu reinigen.

- **NATURBELASSENES TEAK**  
Tischplatten aus diesem schönen, langsam wachsenden Premium Teak von nachhaltig bewirtschafteten Plantagen, das reich an natürlichen Tanninen ist, verfügen auch unter extremen Wetterbedingungen über eine äußerst lange Lebensdauer. Reinigen Sie das Holz mit lauwarmem Wasser unter Hinzugabe von materialschonender Naturseife.

- **MINERALVERBUND-TISCHPLATTE**  
Diese Tischplatten werden speziell für DEDON gefertigt und sind porenfrei, frostbeständig, unempfindlich gegen UV-Strahlung, doppelt so stark wie Glas und sehr widerstandsfähig gegen Kratzer und Abrieb. Verwenden Sie zum Reinigen ein weiches Tuch und warmes Wasser.

## ES LOS ÚLTIMOS RETOQUES PARA SU MESA

Si cristal, teca, aluminio o madera contrachapada termoformada al vapor (HPL), DEDON ofrece una amplia gama de materiales para tablas de mesa. Estos materiales innovadores no solamente se integran bien en los conceptos de las más variadas colecciones, sino que además cumplen con los más altos requisitos de calidad de DEDON para su utilización en mobiliario de exterior.

- **CRISTAL**  
El cristal de seguridad monocapa aumenta la resistencia a los cambios de temperatura y ofrece una excelente resistencia a la flexión, impacto y los golpes. Para limpiar los tableros de las mesas, utilice un paño suave y agua caliente y, si es necesario, un limpiador suave.

- **HPL**  
Laminado de alta presión (HPL) es un material no tóxico altamente resistente al impacto, estrés mecánico, humedad y vapor. Para limpiar los tableros de las mesas, utilice un paño suave y agua caliente y, si es necesario, un limpiador suave.

- **METAL RECUBIERTO EN POLVO**  
Las láminas de metal están recubiertas de una capa en polvo altamente resistente que ofrece a la mesa un rendimiento y una durabilidad incomparables en espacios exteriores. Limpiar con un paño suave y agua tibia.

- **TECA NATURAL**  
Esta maravillosa madera teca de calidad superior y de lento crecimiento, obtenida de plantaciones sostenibles y rica en aceites naturales de taninos, ofrece una gran durabilidad en condiciones meteorológicas extremas. Lavar con agua templada y jabón natural en copos bien disuuelto.

- **TABLERO DE COMPUESTO MINERAL**  
Producidas especialmente para DEDON, este tablero no presentan porosidad, resiste las heladas y los rayos UV, es dos veces más duro que el vidrio y altamente resistente a los arañazos. Limpiar con un paño suave y agua caliente.

## IT IL TOCCO FINALE PER IL VOSTRO TAVOLO

Dal vetro al teak, dall' alluminio all' HPL, DEDON offre un'ampia gamma di materiali diversi per i piani dei tavoli. Questi materiali innovativi non solo si adattano perfettamente al design delle varie collezioni, ma soddisfano anche i massimi requisiti qualitativi richiesti da DEDON per i suoi mobili da esterno.

- **VETRO**  
Il vetro di sicurezza monostrato offre una maggiore resistenza alle variazioni di temperatura e una resistenza eccellente alla flessione, agli impatti e agli urti. Per pulire i piani usare un panno soffice, acqua calda e, se necessario, un detergente delicato.

- **HPL**  
Il laminato ad alta pressione (HPL) è un materiale non tossico estremamente resistente agli impatti, alle sollecitazioni meccaniche, all'umidità e al vapore. Per pulire i piani usare un panno soffice, acqua calda e, se necessario, un detergente delicato.

- **METALLO VERNICIATO A POLVERE**  
Le lamine metalliche sono rivestite da una verniciatura a polvere altamente resistente che conferisce al piano del tavolo eccezionale durezza ed estrema resistenza in ambienti esterni. Pulire con un panno morbido e acqua tiepida.

- **TEAK NATURALE NON TRATTATO**  
Il piano del tavolo in teak è prodotto con un legno di ottima qualità proveniente da piantagioni sostenibili. Questo bellissimo legno a lenta crescita è ricco di oli naturali di tannino ed offre un'ottima resistenza a condizioni meteorologiche estreme. Lavare con acqua tiepida in cui siano stati dissolti fiocchi di sapone naturale.

- **PIANO DEL TAVOLO IN MINERALE COMPOSITO**  
Prodotti in esclusiva per Dedon, questi piani sono privi di pori, resistenti al gelo, insensibili ai raggi UV, due volte più duri del vetro e altamente resistenti ai graffi. Pulire con un panno morbido e acqua tiepida.

## FR LA TOUCHE FINALE POUR VOTRE TABLE

Du verre au teck, de l'aluminium au HPL – DEDON propose une large gamme de matériaux pour les plateaux de table. Non seulement ces matériaux innovants s'inscrivent parfaitement dans le design des différentes collections, mais ils satisfont aussi aux plus hautes exigences de qualité imposées par DEDON pour ses meubles d'extérieur.

- **VERRE**  
Le verre de sécurité monocouche offre une résistance accrue aux changements de température ainsi qu'une excellente résistance à la flexion, aux impacts et aux chocs. Pour nettoyer les plateaux de table, utilisez un chiffon doux et de l'eau chaude et, si nécessaire, un détergent léger.

- **HPL**  
Le stratifié HPL (High Press Laminate) est un matériau non toxique, hautement résistant aux impacts, aux contraintes mécaniques, à l'humidité et à la vapeur d'eau. Pour nettoyer les plateaux de table, utilisez un chiffon doux et de l'eau chaude et, si nécessaire, un détergent léger.

- **MÉTAL THERMOLAQUÉ**  
Les plaques en métal sont dotées d'un revêtement thermolaqué hautement résistant. Ces plateaux de table se distinguent par une durée de vie particulièrement longue et une résistance aux intempéries. Nettoyer avec un chiffon doux et de l'eau chaude.

- **TECK À TEINTE NATURELLE**  
Ce magnifique bois précieux à croissance lente, riche en tanins naturels est particulièrement résistant aux conditions climatiques extrêmes. Nettoyer le plateau en teck avec du savon naturel en paillettes dilué dans de l'eau chaude.

- **DESSUS DE TABLE EN COMPOSITE MINÉRAL**  
Produits spécialement pour DEDON, nos dessus de table sont non-poreux, résistants au gel, aux rayons UV et aux rayures, et deux fois plus solides que le verre. Nettoyer avec un chiffon doux et de l'eau tiède.





# TEAK

## EN THE BEAUTY OF TEAK

Teak is one of the world's most valuable timber resources. Furniture made from this beautiful premium teak, sourced from sustainable plantations is rich in natural tannins and is able to withstand even extreme weather conditions over an exceptionally long lifetime. The wood is resistant to rain, strong sunlight, freezing conditions and fluctuating temperatures. These qualities make it particularly well-suited to long-term outdoor use.

Made using only premium teak, DEDON teak furniture requires no special maintenance besides periodic cleaning. If allowed to age naturally outdoors, it will eventually turn to a soft, silver-gray as surface pigments fade.

To retain its original, golden hue, use DEDON teak oil at least twice a year. To clean it, use a DEDON cleaning agent once or twice a year. To remove any raised grain and restore the surface to a smooth finish, lightly sand from time to time.

For further information on DEDON care products, please visit [www.dedon.de](http://www.dedon.de).

## DE DIE SCHÖNHEIT VON TEAK

Teakholz gehört zu den wertvollsten Nutzhölzern der Welt. Möbel aus diesem schönen Premium Teak von nachhaltig bewirtschafteten Plantagen, das reich an natürlichen Tanninen ist, verfügen auch unter extremen Wetterbedingungen über eine äußerst lange Lebensdauer. Das Holz widersteht Nässe, extremer Sonneneinstrahlung und Kälte sowie Temperaturschwankungen. Es ist daher zum Dauereinsatz im Freien besonders geeignet.

DEDON Teakmöbel benötigen neben einer gelegentlichen Reinigung keiner besonderen Pflege. Setzt man Teak auf natürliche Weise dem Wetter aus, verändert sich seine goldene Farbe und wird zu einem gleichmäßigen silbergrau.

Wünschen Sie einen Erhalt des goldenen Farbtons, streichen Sie mindestens zweimal jährlich das Teak mit DEDON Teak Öl ein. Reinigen Sie das Holz ein- oder zweimal im Jahr mit DEDON Reinigungsmittel. Teakmöbel können auch ab und zu leicht abgeschliffen werden, um raue Maserungen zu entfernen und damit die Oberfläche wieder angenehm glatt wird.

Für weitere Informationen zu DEDON Pflegeprodukten, besuchen Sie unsere Webseite: [www.dedon.de](http://www.dedon.de).

## ES LA BELLEZA DE LA TECA

La madera de teca es una de las maderas útiles más valiosas del mundo. El mobiliario compuesto por esta bonita teca premium, proviene de plantaciones sostenibles, rica en tanino natural, tiene una vida útil extraordinariamente larga incluso en condiciones meteorológicas extremas. La madera es resistente a la humedad, a la radiación solar extrema, al frío y a cambios de temperatura. Por eso, es idónea para el uso permanente al aire libre.

Además de una limpieza periódica, los muebles de teca DEDON no requieren un mantenimiento especial. Si se somete a la teca a condiciones meteorológicas naturales, su color dorado se volverá en un gris plateado uniforme.



Natural teak



Weathered teak

Si se desea conservar su color dorado original, unte la teca al menos dos veces al año con aceite para teca DEDON. Limpie la madera una o dos veces al año con productos de limpieza DEDON. Los muebles de teca se pueden lijar de vez en cuando para eliminar vetas ásperas y restaurar el acabado liso de la superficie.

Para obtener más información sobre los productos de cuidado de DEDON, visite nuestra página web: [www.dedon.de](http://www.dedon.de)

## IT LA BELLEZZA DEL TEAK

Il teak è uno dei legni più preziosi al mondo. I mobili realizzati con questo teak di prima qualità, proveniente da piantagioni sostenibili e naturalmente ricco di oli di tannino, offrono un'eccellente durata nel tempo, anche in condizioni atmosferiche estreme. Il legno resiste all'umidità, alle radiazioni solari molto intense e al freddo così come agli sbalzi di temperatura. È dunque particolarmente adatto all'utilizzo prolungato all'aria aperta. I mobili in teak di DEDON non necessitano di una particolare manutenzione oltre alla pulizia periodica.

Esponendo il teak agli agenti atmosferici in modo naturale, il colore dorato si trasforma in una tonalità omogenea grigio argento. Per conservare la tonalità dorata, il teak va trattato ogni 6 mesi con l'olio per teak di DEDON. Pulire il legno una o due volte all'anno con il detergente di DEDON. Una leggera levigatura dei mobili in teak serve per eliminare le venature ruvide e per mantenere la superficie piacevolmente liscia.

Per ulteriori informazioni sui prodotti per la pulizia di DEDON, visitate il nostro sito: [www.dedon.de](http://www.dedon.de).

## FR LA BEAUTÉ DU TECK

Le teck est l'un des bois les plus précieux au monde. Les meubles fabriqués dans ce beau teck haut de gamme, cultivé dans des plantations à exploitation durable et naturellement riche en tanins, ont une longue durée de vie, même dans des conditions météorologiques extrêmes. Le bois résiste à l'humidité, au rayonnement solaire au froid extrême, ainsi qu'aux variations de température. Il est donc très bien adapté à une utilisation extérieure permanente.

Les meubles en teck DEDON ne nécessitent aucun entretien particulier, excepté un nettoyage occasionnel. Exposé aux aléas météorologiques, la couleur dorée du teck laisse place à un gris argenté homogène.

Si vous souhaitez conserver la teinte dorée, enduisez au moins deux fois par an le teck d'huile spécifique pour teck DEDON. Nettoyez le bois une ou deux fois par an avec un produit nettoyant DEDON. Les meubles en teck peuvent également être légèrement poncés de temps en temps afin de supprimer les grains du bois rugueux : leur surface sera de nouveau lisse et agréable au toucher.

Vous trouverez de plus amples informations quant aux produits d'entretien DEDON sur notre site Internet: [www.dedon.de](http://www.dedon.de).



# COVER

## EN DEDON COVERS – HANDLING AND CARE

DEDON furniture covers are made of Weathermax®, a heavy-duty, 100%-solution-dyed polyester fabric. Weathermax® is water-resistant and UV-resistant, with outstanding breathability and durability. Because of their superior breathability, DEDON covers minimize dampness, heat build-up and condensation, helping to prevent mold and mildew from forming on your furniture.

Tailored to fit perfectly over their corresponding products, DEDON covers feature zippers for easy draping as well as elastic straps and loops (product-specific) for securing them in windy conditions. Clean covers with warm water and a gentle upholstery cleaner. Before storing, allow them to dry by hanging them using the featured strap (not part of all covers). Do not bleach or iron.

All cushions should be dry before applying DEDON covers. For longer periods, e.g. during wintertime, we recommend storing your cushions in a dry place indoors.

## DE DEDON HUSSEN – HANDHABUNG UND PFLEGE

Die DEDON Hussen bestehen aus dem Stoff Weathermax®, einem zu 100% in Masse gefärbten, extrem strapazierfähigen Polyester. Weathermax® ist sowohl resistent gegen UV-Strahlung als auch wasserfest, luftdurchlässig und langlebig. Die Luftdurchlässigkeit des Materials ist zur Reduzierung von Feuchtigkeit, Wärmeentwicklung und Kondensation sehr wichtig. Das wiederum beugt Schimmelbildung auf oder in den Möbeln vor.

Die Hussen wurden den Maßen Ihres Möbelstückes genau angepasst. Sie sind—je nach Produkt—mit Reißverschlüssen, elastischen Nähten und Schlaufen ausgestattet, damit sie einfach über dem Möbel platziert und bei Wind festgezurr werden können. Reinigen Sie die Hussen mit einem weichen Tuch und warmem Wasser. Wenn nötig, verwenden Sie einen schonenden Polsterreiniger. Nicht bleichen, nicht bügeln.

Stellen Sie sicher, dass sowohl die Möbel als auch die Kissen vollständig trocken sind, bevor Sie sie abdecken. Für die dauerhafte Lagerung (beispielsweise während der Wintermonate) raten wir Ihnen die Kissen im Innenraum aufzubewahren.

## ES FUNDAS DEDON – USO Y MANTENIMIENTO

Las fundas DEDON están fabricadas con Weathermax®, un tejido 100% de poliéster teñido de alta resistencia. Weathermax® es un material hidrófugo y resistente a los rayos UV, con una excelente transpiración y durabilidad. Gracias a su gran transpiración, las fundas DEDON reducen la formación de humedad, la acumulación de calor y la condensación, ayudando a prevenir la formación de moho en los muebles.

Adaptadas para encajar perfectamente en los productos correspondientes, las fundas DEDON incluyen cremallera, cintas elásticas y cierres (específicos para cada producto) para asegurarlas cuando hace viento. Lavar las fundas con agua tibia y un limpiador suave para tapicería. Antes de guardarlas, colgarlas para que se sequen usando las cintas (no incluidas en todas las fundas). No usar lejía ni planchar.

Los cojines deben estar secos antes de poner las fundas DEDON. Para periodos largos, como por ejemplo durante el invierno, recomendamos guardar los cojines en un lugar interior seco.

## IT HOUSSE DEDON – IMPIEGO

Le fodere DEDON sono in Weathermax®, un tessuto di poliestere 100% tinto in massa, estremamente resistente. Weathermax® è resistente sia ai raggi UV, sia all'acqua, è traspirante e durevole. La traspirabilità del materiale è molto importante per ridurre l'umidità, la formazione di calore e la condensa, prevenendo la formazione di muffa sui vostri mobili.

Le fodere sono state realizzate a misura per rivestire perfettamente i vostri mobili. Sono dotate – a seconda del prodotto – di chiusure a strappo, cuciture elasticizzate e occhielli, grazie ai quali si può rivestire il mobile con facilità e avere un fissaggio sicuro quando soffia il vento. Pulire le fodere con un panno morbido e acqua calda, utilizzando, se necessario, un detergente delicato per imbottiti. Non candeggiare, non stirare.

Assicurarsi che sia i mobili, sia i cuscini siano completamente asciutti prima di coprirli con le federe. Per lo stoccaggio prolungato (ad esempio nei mesi invernali) si consiglia inoltre di riporre i cuscini in ambiente chiuso.

## FR HOUSSES DEDON – MANIEMENT ET ENTRETIEN

Les housses pour les meubles DEDON sont fabriquées en Weathermax®, un tissu robuste, 100% polyester teinté dans la masse. Weathermax® résiste à l'eau, aux rayons UV et est incroyablement durable et respirable. Grâce à leur respirabilité supérieure, les housses DEDON réduisent l'humidité, l'accumulation de chaleur et la condensation, empêchant ainsi la formation de moisissure sur vos meubles.

Conçues pour s'adapter parfaitement aux produits leur correspondant, les housses DEDON comprennent une fermeture Éclair pour faciliter leur mise en place, ainsi que des bandes et des boucles élastiques (en fonction du produit) pour les fixer en cas de vent. Nettoyez les housses avec de l'eau chaude et un nettoyeur pour tissus doux. Avant de les ranger, laissez sécher les housses en les accrochant par la bande prévue à cet effet (disponible que pour certains modèles). Ne pas utiliser d'eau de Javel sur les housses ni les repasser.

Assurez-vous que les coussins sont bien secs avant d'utiliser les housses DEDON. Pour les périodes prolongées, par exemple durant l'hiver, nous recommandons de conserver vos coussins à l'intérieur et au sec.







## INDEX CUSHIONS

- 8-9 BREA: TWIST sand **661**
- 10 BREA: KVADRAT patio450 **678**
- 11 BREA: TWIST sand **661**
- 12-13 BREA: TWIST sand **661**,  
KVADRAT patio450 **678**
- 14-15 MBRACE: TWIST sand **661**
- 16 MBRACE: COOL taupe **452**
- 17 MBRACE: TABRIZ topaz/blue **568**
- 18-19 MBRACE: COOL taupe **452**
- 20 MBRACE: COOL taupe **452**
- 22-23 MBRACE: COOL taupe **452**
- 28-29 TIBBO: TWELLO night **628**
- 30-31 TIBBO: TWIST sand **661**
- 32 TIBBO: COOL marengo **455**
- 33 TIBBO: COOL marengo **455**
- 34-35 TIBBO: COOL taupe **452**
- 40-41 SLIM LINE: COOL off white **451**
- 42 NESTREST: COOL white **450**
- 43 NESTREST: COOL white **450**
- 44 ORBIT: COOL white **450**
- 45 ORBIT: COOL white **450**
- 46 SWINGREST: COOL white **450**
- 47 SWINGREST: COOL white **450**
- 48 TIGMI: COOL white **450**
- 49 TIGMI: COOL white **450**
- 52 AIIR: TWIST terracotta **663**,  
TWIST dark turquoise **664**,  
COOL ash **458**
- 54 AIIR: TWIST terracotta **663**
- 56-57 AIIR: TWIST terracotta **663**
- 64-65 MU: COOL taupe **452**;  
LINEN taupe **640**;  
SeaX: CURL taupe **613**
- 66 MU: COOL taupe **452**
- 67 MU: COOL taupe **452**
- 68-69 BRIXX: DUNE cove/shore **697**
- 70 BRIXX: DUNE cove/shore **697**
- 71 BRIXX: PUNO reed **696**,  
PUNO straw/reed **694**
- 72-73 BRIXX: DUNE cove/shore **697**
- 76-77 LOUNGE: COOL dark gray **454**
- 78 LOUNGE: COOL dark gray **454**
- 79 LOUNGE: COOL dark gray **454**
- 80 PANAMA: TWIST gray **662**
- 81 PANAMA: TWIST gray **662**
- 83 BARCELONA: COOL white **450**
- 85 TANGO: COOL white **450**
- 86-87 SEASHELL: COOL white **450**
- 88-89 LOU: COOL taupe **452**
- 91 LOU: COOL taupe **452**
- 92-93 RAYN: LINEN warm gray **652**
- 94 RAYN: LINEN warm gray **652**
- 98-99 AHNDA: TABRIZ taupe/gray **567**
- 100 AHNDA: COOL taupe **452**
- 101 AHNDA: COOL taupe **452**
- 121 AIIR: COOL ash **458**
- 139 TIBBO: COOL marengo **455**
- 283 MBRACE: COOL taupe **452**
- 291 BARCELONA: TWIST sand **661**
- 292 TIBBO: TWELLO night **628**
- 296 MU: LINEN taupe **640**
- 299 BREA: KVADRAT patio450 **678**
- 302 BRIXX: PUNO reed **696**



# KVADRAT FABRICS



## PATIO CATEGORY B Trevira CS

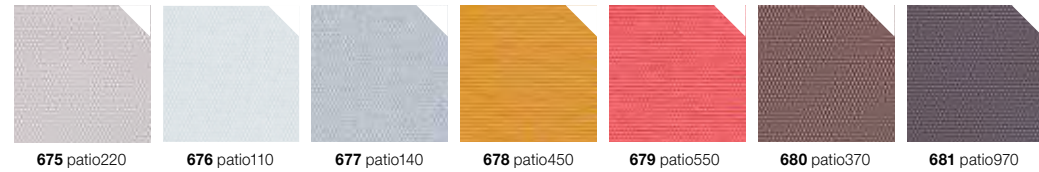

### EN KVADRAT PATIO

KVADRAT Patio, an upholstery textile developed for outdoors, offers exceptional color vibrancy. The result of three years of intensive research, it is a perfect fit with DEDON's standards of quality and design.

Designed by Karina Nielsen Rios, Patio is made with a highly durable, specially developed Trevira CS yarn. It features a fluorocarbon-free, environmentally-focused finish that is water-repellent and fast-drying. It provides resistance against chlorine, seawater and artificial weathering and is flame-retardant. In addition to its technical features, it stands out for its soft touch.

Patio has a subtle structure that combines two colored yarns in the warp and one in the weft. Depending on the level of contrast between the colors, Patio can appear almost unicolored or more textured. Patio is suitable for all outdoor spaces, as well as for areas such as spas and indoor pools, where high-humidity and chlorine are a factor.

DEDON has selected seven different color ways of Patio. They represent a range of aesthetic approaches and complement DEDON's 33 fabrics.

### DE KVADRAT PATIO

KVADRATs Patio ist ein Möbelstoff, der für den Außenbereich entwickelt wurde und über beeindruckend lebendige Farben verfügt. Er ist das Ergebnis einer intensiven, dreijährigen Forschung und passt perfekt zu DEDONs Ansprüchen an Qualität und Design.

Das von Karina Nielsen Rios entworfene Textil ist aus einem speziell hierfür entwickelten, sehr strapazierfähigen Trevira CS-Garn gefertigt. Patio verfügt über ein fluorocarbonfreies, umweltfreundliches Finish, das wasserabweisend und schnell trocknend ist. Zudem ist es resistent gegen Chlor und Salzwasser und ist witterungsbeständig sowie flammenfest. Neben den technischen Eigenschaften hebt sich der Stoff besonders durch seine weiche Haptik hervor.

Patio kommt mit einer dezenten Struktur, bei der zwei farbige Garne in der Kette und ein Garn im Schuss kombiniert werden. Je nach Stärke des Kontrasts der Farben erscheint Patio entweder fast einfarbig oder eher strukturiert. Patio ist für alle Außenbereiche geeignet sowie für andere Bereiche, in denen mit hoher Feuchtigkeit und Chlor zu rechnen ist, beispielsweise Spas und Schwimmbäder.

DEDON hat sieben einzigartige Patio Farben ausgewählt, die die Farbwelt von DEDON komplettieren.

### ES KVADRAT PATIO

Patio de KVADRAT es un tejido de tapicería desarrollado para exteriores y que ofrece colores vibrantes únicos. Después de tres años de intensa investigación, Patio cumple a la perfección con los estándares de calidad y diseño de DEDON.

Diseñado por Karina Nielsen Rios, Patio se ha confeccionado con hilo de Trevira CS especial de gran durabilidad. Ofrece un acabado libre de fluorocarbono y respetuoso con el medio ambiente que es impermeable y se seca rápidamente. También es ignífugo y resistente al cloro, al agua de mar y al desgaste artificial. Aparte de sus características técnicas, destaca por su tacto suave.

Patio presenta una estructura sutil que combina hilos de dos colores en la urdimbre y un color en la trama. Dependiendo del grado de contraste cromático, Patio parece prácticamente unicolor o con una textura más marcada. Patio está pensado para espacios exteriores así como para zonas de spa o piscinas cubiertas donde hay altos niveles de cloro y humedad.

DEDON ha seleccionado siete colores diferentes de Patio que representan una variedad de enfoques estéticos y complementan los 33 tejidos de DEDON.

### IT KVADRAT PATIO

KVADRAT Patio, il tessuto per rivestimenti creato per esterni, è presentato con colorazioni di eccezionale brillantezza. Tre anni di intenso lavoro di ricerca hanno portato alla creazione di un complemento perfettamente in linea con gli standard qualitativi e il design DEDON.

Disegnato da Karina Nielsen Rios, Patio è realizzato con un filato in Trevira CS dalla speciale lavorazione ed alta resistenza. Patio presenta una finitura ecologica senza fluorocarburi, idrorepellente ed ad asciugatura rapida. È resistente al cloro, all'acqua marina e alle condizioni atmosferiche artificiali e ha proprietà ignifughe. Oltre che per le sue caratteristiche tecniche, si distingue per la sua morbidezza al tatto.

Patio presenta una struttura sottile, che combina due filati colorati nell'ordito e uno nella trama. A seconda del livello di contrasto tra i colori, Patio può apparire quasi monocromatico oppure più testurizzato. Patio è adatto per tutti gli spazi esterni, per spa e piscine coperte, in cui sono presenti umidità elevata e cloro.

DEDON ha selezionato sette diverse linee di colori per Patio. Esse rappresentano una gamma di approcci estetici a complemento dei 33 tessuti DEDON.

### FR KVADRAT PATIO

KVADRAT Patio est un tissu de revêtement développé pour un usage extérieur aux couleurs d'une vivacité exceptionnelle. Ce résultat de trois ans de recherche intensive correspond parfaitement aux normes de DEDON en matière de qualité et de design.

Créé par Karina Nielsen Rios, il est fabriqué avec un fil Trevira CS exclusif très résistant. Il présente une finition garantie sans fluorocarbure respectueuse de l'environnement, hydrofuge et capable de sécher rapidement. Ignifuge, il résiste également au chlore, à l'eau de mer et aux simulations artificielles d'intempéries. Au-delà de ses propriétés techniques, il se distingue par sa douceur.

Patio se décline dans une texture subtile avec deux fils colorés en trame et un en chaîne. Selon le niveau de contraste entre les coloris, Patio apparaît soit uni, soit plus texturé. Patio est adéquat pour tous les espaces extérieurs, mais aussi à l'intérieur, dans des locaux très humides et riches en chlore (des piscines ou des spas par exemple).

DEDON a sélectionné sept coloris différentes pour Patio. Elles symbolisent une gamme d'approches esthétiques et complètent les 33 tissus DEDON.







## DECO CUSHIONS

### DECO CUSHIONS

Dekokissen  
Cojines de decoración  
Cuscini decorativo  
Coussins déco

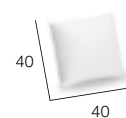

95050081

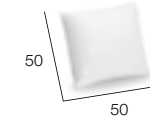

95050082

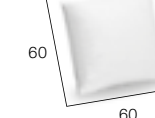

95050084



95050086



ø40

95050088



95050089

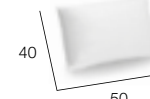

95050085



95050083



95050090

### DEDON fabrics per meter

DEDON Stoffe Meterware  
DEDON tela a metros  
DEDON tessuti al metro  
DEDON tissus au mètre



140

95060092

## LA MALLE CUSHIONS TRUNK

Design by LORENZA BOZZOLI & THE KINGS

### CUSHIONS TRUNK XL

Kissentruhe XL  
Baúl para cojines XL  
Baule per cuscini XL  
Coffre à coussins XL  
66,5 kg 1,58 m<sup>3</sup>

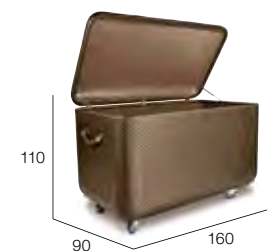

110

90

160

072010040

INTERIOR DIMENSIONS (W x H x D)  
Abmessungen innen (B x H x T)  
Dimensiones interiores (a x a x f)  
Dimensioni interne (L x H x P)  
Dimensions partie intérieure (L x H x P)  
152 x 82 x 87 cm



### 072010

**EN** Opening and closing of the lid is assisted by pneumatic springs. All trunks are designed for short-term storage of DEDON cushions and pillows. Ensure the cushions are completely dry before storing them in the trunk. The trunk can be used in covered outdoor areas as well as indoors. Customized XL cushions trunk available in other DEDON weaves and colors, subject to surcharge.

**DE** Das Öffnen und Verschließen des Deckels wird durch Gasdruckfedern unterstützt. Alle Truhen dienen einem kurzzeitigen Verstauen der DEDON Kissen und Polster. Stellen Sie sicher, dass die Kissen vollständig trocken sind, bevor Sie sie in die Truhe legen. Die Truhe ist im überdachten Außenbereich sowie im Innenbereich einsetzbar. Individuell angefertigte Kissentruhe XL in anderen DEDON Flechtungen und Farben gegen Aufpreis möglich.

**ES** Unos muelles neumáticos facilitan la apertura y el cierre de la tapa. Todos los baúles sirven para almacenar cojines y acolchados durante un breve período de tiempo. Asegúrese de que los cojines estén completamente secos antes de depositarlos en el baúl. El baúl se puede utilizar en exteriores techados y en interiores. El baúl para cojines XL con acabado personalizado se puede adquirir en otras fibras DEDON y colores bajo recargo adicional.

**IT** L'apertura e la chiusura del coperchio sono facilitate da molle pneumatiche. Tutti i bauli sono progettati per riporre i cuscini DEDON per brevi periodi. Assicuratevi che i cuscini siano completamente asciutti prima di metterli nei bauli. I bauli sono utilizzabili sia in ambienti esterni che interni. Il baule per cuscini XL può essere realizzato in altre varianti di colore DEDON con un supplemento di prezzo.

**FR** L'ouverture et la fermeture du couvercle est assistée par des ressorts à gaz. Tous les coffres permettent de ranger les coussins et les matelas de DEDON pour une courte durée. Assurez-vous que les coussins sont entièrement secs, avant de les ranger dans le coffre. Le coffre peut être utilisé dans un espace extérieur protégé des intempéries ainsi qu'à l'intérieur. Coffre à coussins XL personnalisé, disponible sur demande dans d'autres fibres et coloris DEDON, moyennant un supplément.





# CUSHIONS & FABRICS

## EN CUSHIONS YOU CAN LEAVE OUTDOORS

DEDON relies on some of the world's most advanced textile technologies to create cushions you can leave outside. Our high-quality acrylic materials are UV-resistant and specially treated to make them splash-resistant, with no loss of comfort. The foam cores, created exclusively for DEDON, and synthetic fiber padding are surrounded by a water-repellent, breathable, spun-bonded wrap. After a shower of rain, allow your cushions to dry so as to protect them from mold stains. We recommend storing your cushions for the winter or when not in use for long periods, and using covers to keep them at their best. Before storing, make sure they are completely dry. Our materials meet the highest standards of quality for outdoor usage. All fabrics are quick-drying and easy to maintain.

## NINE FABRIC STYLES TO PLAY WITH

Each of the nine fabric styles in this catalog has a distinctive weaving structure that gives it a look and feel all its own. While any one of these fabrics is an ideal covering for cushions large or small, it's the opportunity to combine them that makes the DEDON collection so special. Play with textures. Mix the summery lightness of COOL with the tweedy robustness of TWELLO. Create subtle differences of shade by working with multiple fabric structures in the same color. The flexibility and creativity long associated with the finest indoor fabrics can now be enjoyed under the open skies.

## DE KISSEN, DIE DRAUSSEN BLEIBEN KÖNNEN

DEDON setzt die weltweit modernsten Textiltechnik-Verfahren ein, damit Ihre Kissen auch mal draußen bleiben können. Dank einer speziellen Behandlung sind unsere hochwertigen Acrylmateriale spritzwassergeschützt—ohne sich deshalb weniger komfortabel anzufühlen. Darüber hinaus sind sie beständig gegen UV-Strahlen. Der speziell für DEDON hergestellte Schaumstoffkern und die Kunstfaserpolsterung werden durch einen wasserabweisenden und gleichzeitig atmungsaktiven Spinnvliesstoff umhüllt. Lassen Sie Ihre Kissen nach einem Regenschauer trocknen, um sie vor Stockflecken zu schützen. Verstauen Sie Ihre Kissen im Winter oder wenn Sie sie über längere Zeit nicht nutzen. Am schönsten bleiben die Kissen, wenn Sie sie mit DEDON Hussen abdecken. Stellen Sie vor dem Verstauen und Abdecken sicher, dass die Kissen vollständig trocken sind. Unsere Materialien entsprechen den höchsten Qualitätsstandards für die Nutzung im Freien. Sämtliche Materialien sind schnelltrocknend und pflegeleicht.

## NEUN STOFFVARIATIONEN BIETEN ABWECHSLUNG

Jede der neun Stoffvarianten in diesem Katalog hat ihre eigene unvergleichliche Webstruktur und damit einen ganz einzigartigen Look & Feel. Während sich jeder unserer Stoffe perfekt als Bezug für unsere Kissen eignet, egal ob klein oder groß, sind es insbesondere die vielfältigen Kombinationsmöglichkeiten der Stoffe untereinander, die die DEDON Stoffkollektion so attraktiv machen. Spielen Sie mit den Texturen, etwa indem Sie die sommerliche Frische von COOL mit der Robustheit von TWELLO kombinieren, die an Tweed-Stoffe erinnert. Schaffen Sie subtile Farbnuancen, indem Sie mit unterschiedlichen Strukturen in der gleichen Farbwelt arbeiten. Freuen Sie sich, dass Sie unter freiem Himmel ebenso abwechslungsreich und kreativ sein können, wie Sie es von den feinsten Indoor-Stoffen gewohnt sind.

## ES COJINES QUE PUEDES DEJAR EN EL EXTERIOR

DEDON se basa de las tecnologías textiles más avanzadas del mundo para crear cojines que pueda dejar en el exterior. Nuestros materiales acrílicos de alta calidad están especialmente recubiertos para ser resistentes a las salpicaduras de agua sin que ello suponga una pérdida del confort. Además, son resistentes a los rayos UV. Los núcleos de espuma, creados exclusivamente para DEDON, y el relleno de fibra sintética están cubiertos por una envoltura impermeable, transpirable y no tejida. Después de un aguacero, permita que sus cojines se sequen con el fin de protegerlos de las manchas de moho. Le recomendamos que guarde sus cojines durante el invierno o cuando no se usen durante largos períodos de tiempo, y usar las fundas para mantenerlos siempre óptimos. Antes de guardarlos, asegúrese de que están completamente secos. Nuestros materiales cumplen con los más altos estándares de calidad para uso al aire libre. Todos los tejidos son de secado rápido y fáciles de mantener.

## NUEVE TIPOS DE TEJIDOS PARA COMBINAR

Cada uno de los nueve tejidos que hay en este catálogo posee su propia estructura de tejido que lo diferencia y le confiere, por lo tanto, una apariencia y un tacto completamente únicos. Aunque cualquiera de los tejidos que se ofrecen sería un recubrimiento ideal tanto para cojines grandes como pequeños, la oportunidad sin precedentes de combinar múltiples tejidos es lo que confiere un gran atractivo a las colecciones de DEDON. Juegue con las texturas combinando la fresca veraniega de COOL con la robustez de TWELLO que recuerda al tejido tweed. Cree sutiles matices trabajando con el mismo color en diferentes texturas. Disfrute de poder combinar y crear bajo cielo abierto de la misma manera que con los exquisitos tejidos de interior.

## IT CUSCINI DA POTER LASCIARE ALL'ESTERNO

DEDON sfrutta alcune delle tecnologie più avanzate del mondo nel settore tessile per creare cuscini da poter lasciare all'esterno. Grazie a un rivestimento particolare, i nostri materiali acrilici sono resistenti agli spruzzi d'acqua, senza perdere la loro comodità. Sono anche resistenti ai raggi UV. Le anime in schiuma, create esclusivamente per DEDON e le imbottiture in fibra sintetica sono inserite in un involucro idrorepellente, traspirante, in tessuto non tessuto. Dopo la pioggia, far asciugare i cuscini in modo da prevenire la formazione di macchie di umidità. In inverno o in caso di lunghi periodi di inutilizzo, si consiglia di riporre i cuscini coprendoli con dei tel per mantenerli al meglio. Prima di riporli, assicurarsi che siano perfettamente asciutti. I nostri materiali rispondono ai più rigorosi standard di qualità per l'uso outdoor. Tutti i tessuti sono di rapida asciugatura e di facile manutenzione.

## NOVE TIPI DIVERSI DI TESSUTI PER SBIZZARRIRISI

Tutti i nove tipi di tessuti in questo catalogo hanno una struttura di tessuto con un look particolare. Ogni stoffa si presta perfettamente come fodera per i cuscini, piccoli o grandi che siano. Quello che realmente rende così speciale la collezione Dedon è la possibilità di creare infinite combinazioni di stoffe. Giocate con i tessuti, combinando la freschezza estiva di COOL con la robustezza del tessuto TWELLO, che ricorda le stoffe tweed. Create sottili nuance di colori, lavorando con strutture diverse nella stessa tonalità di colore. Date libero sfogo alla vostra creatività negli ambienti esterni così come siete abituati a fare con i più pregiati tessuti per interni.

## FR DES COUSSINS QUE VOUS POUVEZ LAISSER DEHORS

DEDON travaille avec les technologies textiles les plus avancées au monde pour concevoir des coussins que vous pouvez laisser dehors. Grâce à un revêtement spécifique, nos matériaux acryliques de haute qualité sont protégés contre les éclaboussures, sans que cela n'influe sur leur confort. En outre, ils sont résistants aux rayons UV. Le cœur en mousse, conçu spécialement pour DEDON, et le rembourrage en fibres synthétiques sont enveloppés dans un tissu non-tissé respirable et hydrofuge. Après une averse, faites sécher vos coussins, afin de prévenir l'apparition de moisissure. Nous vous recommandons de ranger vos coussins pendant l'hiver ou lorsqu'ils ne sont pas utilisés sur le long-terme et d'utiliser des housses pour conserver leur qualité. Avant de les ranger, assurez-vous qu'ils soient complètement secs. Nos matériaux sont un gage de qualité pour une utilisation extérieure. Tous les tissus sèchent rapidement et sont faciles d'entretien.

## NEUF TYPES DE TISSUS PERMETTENT DE VARIER

### LES PLAISIRS

Chacune des neuf variantes de tissus présentées dans ce catalogue dispose de sa propre structure tissée incomparable. De fait, son style est unique et l'impression laissée par sa vue et son toucher est sans pareille. Si chacun de nos tissus est parfaitement approprié pour recouvrir les housses de nos coussins, qu'ils soient petits ou grands, ce sont surtout les possibilités de combinaison qui rendent l'assortiment de tissus DEDON si intéressant. Jouez avec les textures, en combinant la fraîcheur estivale de COOL et la robustesse de TWELLO qui rappelle les tissus en tweed. Créez des nuances de couleurs subtiles en combinant différentes structures dans le même contexte chromatique. Réjouissez-vous de pouvoir laisser libre cours à votre créativité et à la diversité en plein air comme vous y êtes habitué avec les tissus d'intérieur les plus nobles.





# FABRICS

## COOL CATEGORY A Acrylic

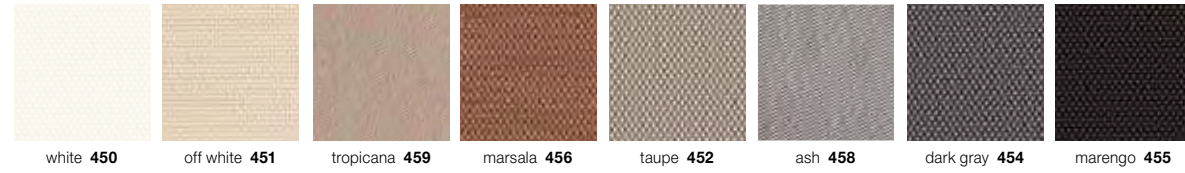

## LINEN CATEGORY B Acrylic

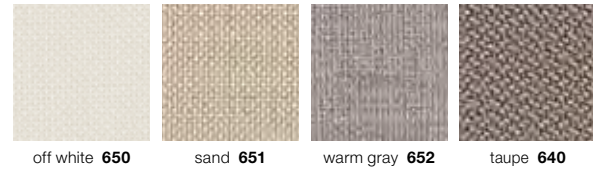

## KNOTT CATEGORY B Acrylic

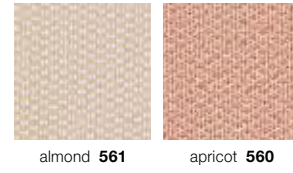

## TWIST CATEGORY B Polypropylene



## TABRIZ CATEGORY B Acrylic

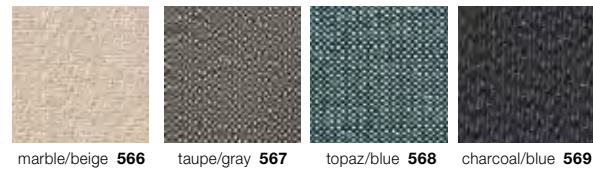

## TWELLO CATEGORY B Acrylic

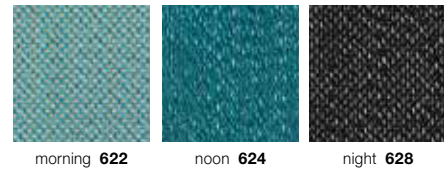

## CURL CATEGORY B Acrylic

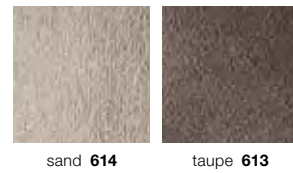

## DUNE CATEGORY C Acrylic



## PUNO CATEGORY C Acrylic

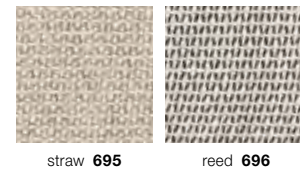

Fabrics for BRIXX, BRE A collection and deco cushions only.  
 Stoffe nur für BRIXX und BRE A-Kollektion, sowie Dekokissen erhältlich.  
 Telas estan solamente disponibles para las colecciones BRIXX, BRE A y los cojines decorativos.  
 Tessuto disponibile solo per le collezioni BRIXX e BRE A e per i cuscini decorativi.  
 Tissu uniquement disponible pour les collections BRIXX et BRE A et les coussins déco.

# FABRICS

## COOL



With its simple strié weave, this summerly outdoor fabric is cool, light and soft. An outstanding carrier of colors, from soothing taupe to brighter tropicana and marsala, the fabric has a natural look and feel that's reminiscent of cotton.

## LINEN



Specially developed for a natural look and feel, this linen-like outdoor fabric is characterized by its distinctive weave, exceptional comfort and contemporary selection of colors.

## KNOTT



This soft and natural-looking outdoor fabric is made with heavy-weight yarns. It features a classic basket weave that gives the impression of a cosy knit. The yarns have an inviting hand-feel and a pearlescent shine.

## TWIST



A soft outdoor fabric with the natural look of linen, TWIST is woven from a fine twisted yarn that gives it depth, structure and a lively color effect.

All fabrics are quick-drying, UV-resistant and easy to maintain.

## TABRIZ



This jacquard fabric features different sizes of yarn for a luxuriously raw and natural linen effect. Fluid, drapable and soft to the touch, it comes in a range of outstanding color combinations, from tone-on-tone to high-contrast.

## TWELLO

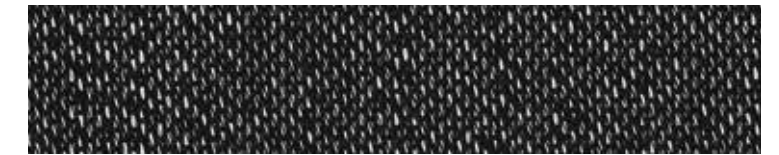

Inviting to the touch, this robust, heavy-weight outdoor fabric features a tweed weaving structure that enhances the yarns' natural look and feel. The yarns themselves are twisted for a fresh, crisp effect.

## CURL



Luxuriously soft and fluffy, this medium-weight outdoor terrycloth is made with loop yarn for a towel-like texture and handfeel.

## DUNE / PUNO

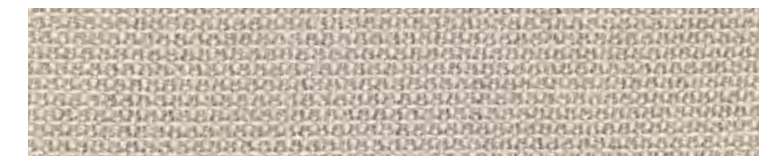

Chunky yarns in a classic basket weave give this soft and inviting fabric a natural look and feel. The yarns are made with 50-percent recycled post-industrial fiber for a naturally diverse combination of colors that demonstrates the beauty of imperfection.



# QUALITY

## EN FIVE REASONS FOR CHOOSING DEDON

**PRODUCED IN OUR OWN FACILITIES**

The manufacturing of both DEDON fiber in Germany and DEDON furniture in the Philippines take place in our own production facilities. This is unique in the outdoor furniture industry and ensures that fine craftsmanship is combined with innovative technology. DEDON's master weavers in the Philippines use ultra-strong fibers from our own DEDON production.

#### WORLD'S BEST FIBER

No matter if it's desert wind, salt water or frost, DEDON fiber is tested against all weather conditions and for 10 years' UV resistance. Produced in Germany by our team of specialists, it is unrivaled for strength, color fastness and longevity. And because DEDON fiber is developed entirely in-house, we are able to work with designers to create innovative solutions, including unique colors, textures and profiles.

#### THE RIGHT MATERIAL FOR EVERY SETTING

Specialists in outdoor living spaces of all kinds, DEDON selects the right material for every setting, from covered terraces to exposed poolsides to sandy beaches to wild nature. That's why, in addition to the world's best fiber, we work with highest-quality teak, aluminum, woven textiles, ceramics and upholstery, all manufactured with passion for excellence.

#### SUSTAINABILITY

It is DEDON's corporate philosophy to create furniture and accessories of such high quality that they need never be thrown away. Produced in our environmentally-sound facilities in Northern Germany, DEDON fiber is 100% recyclable and free from pollutants and heavy metals. In addition DEDON incorporates recycled materials into our products whenever feasible.

#### DESIGN

DEDON collaborates with the world's top designers, from famous names to rising stars, on collections that consistently win the most prestigious design awards. Our in-house research and development department is able to work closely with each designer on solutions and innovations that make all the difference in terms of quality, function and style.

## DE FÜNF GRÜNDE FÜR DEDON

**EIGENE PRODUKTION**

Sowohl die Herstellung der DEDON Faser in Deutschland, als auch die Möbelproduktion auf den Philippinen findet in eigenen Produktionsstätten statt – dies ist einzigartig in der Outdoor-Möbel-Branche. Handwerkskunst verbindet sich mit innovativer Technik – die DEDON Meisterflechter auf den Philippinen verwenden hochbelastbare Fasern aus der eigenen DEDON Produktion.

#### DIE WELTBESTE FASER

Egal ob Wüstenwind, Salzwasser oder Frost – die DEDON Faser ist gegen alle Witterungen und auf 10 Jahre UV-Beständigkeit getestet. Die in Deutschland von unserem Spezialistenteam hergestellte Faser ist in Sachen Festigkeit, Farbbeständigkeit und Langlebigkeit konkurrenzlos. Und weil wir bei DEDON unsere Fasern komplett im eigenen Hause entwickeln lassen, können wir in Zusammenarbeit mit unseren Designern innovative Lösungen entwickeln - einschließlich neuer Farben, Oberflächen und Faserprofile.

#### DIE RICHTIGEN MATERIALIEN FÜR JEDE UMGEBUNG

Als Spezialisten für alle Bereiche des Outdoor Living setzen wir bei DEDON auf die richtigen Materialien für jedes Umfeld, von der schattigen Terrasse zur prallen Sonne eines Poolbereichs, vom feinen Sandstrand bis zur wilden Naturlandschaft. Deshalb verwenden wir nicht nur die weltbeste Faser, sondern setzen auch ausschließlich Teakholz, Aluminium, Webtextilien, keramische Materialien und Polsterungen von höchster Qualität ein, die mit leidenschaftlichem Qualitätswillen gefertigt wurden.

#### NACHHALTIGKEIT

Es ist Teil der Unternehmensphilosophie von DEDON, dass wir Möbel und Accessoires von so hoher Qualität fertigen, dass sie ein Leben lang halten. Die DEDON-Faser, die in unserer umweltverträglich arbeitenden Produktionsstätte in Norddeutschland hergestellt wird, ist zu 100% recycelbar und frei von Schadstoffen und Schwermetallen. Darüber hinaus setzen wir bei der Herstellung unserer Produkte so oft wie möglich recycelte Materialien ein.

#### DESIGN

DEDON arbeitet mit Top-Designern aus aller Welt — vom Designer mit großem Namen bis zum aufstrebenden Jungdesigner — zusammen. So entstehen Kollektionen, die immer wieder die prestigeträchtigsten Designpreise gewinnen. Dabei arbeitet unsere hauseigene Entwicklungsabteilung eng mit den Designern zusammen, um so Lösungen und Innovationen zu schaffen, die sich in Qualität, Funktionalität und Stil entschieden absetzen.

## ES CINCO MOTIVOS PARA ELEGIR DEDON

**PRODUCCIÓN PROPIA**

Tanto la fabricación de la fibra DEDON en Alemania como la producción de muebles en Filipinas se desarrollan en nuestros propios centros, una característica única dentro del sector del mobiliario de jardín. El trabajo artesanal se combina con la tecnología más innovadora: como resultado, los maestros tejedores de Filipinas emplean fibra de alta resistencia, fabricada por DEDON en régimen de producción propia.

#### LA MEJOR FIBRA DEL MUNDO

Da igual que sea viento del desierto, agua de mar o escarcha: la fibra DEDON ha demostrado que es capaz de resistir todas estas agresiones y soportar sin alteraciones la acción de los rayos ultravioleta hasta 10 años. Fabricada en Alemania por nuestro equipo de especialistas, no tiene rival en lo que se refiere a fortaleza, solidez del color y durabilidad. Y dado que la fibra DEDON es se desarrolla completamente en casa, podemos trabajar conjuntamente con nuestros diseñadores para crear soluciones innovadoras, incluyendo colores, superficies y formas nuevas.

#### MATERIALES CORRECTOS PARA TODOS LOS AMBIENTES

Siendo especialista en todo tipo de espacios al aire libre, DEDON selecciona el material correcto para cada ambiente: desde terrazas cubiertas a pícinas con sol abrasador directo, desde playas arenosas hasta naturaleza salvaje. Por eso, además de la mejor fibra del mundo, trabajamos también con madera teca, aluminio, tejidos textiles, cerámicas y tapizados de la más alta calidad, todos fabricados con la mejor calidad.

#### SOSTENIBILIDAD

La filosofía corporativa de DEDON es fabricar muebles y accesorios de tan alta calidad que duren toda la vida. La fibra DEDON se fabrica en nuestras instalaciones seguras y respetuosas con el medio ambiente del norte de Alemania. Es 100% reciclable y no contiene ningún tipo de sustancias tóxicas ni metales pesados. Además, siempre que sea factible, incorporamos materiales reciclados en nuestros productos.

#### DISEÑO

DEDON colabora con los mejores diseñadores del mundo, desde reputados diseñadores, hasta diseñadores emergentes, para crear colecciones que siempre ganan los premios de diseño más prestigiosos. Nuestro departamento de investigación y desarrollo trabaja estrechamente con los diseñadores para crear soluciones e innovaciones que marquen la diferencia en términos de calidad, funcionalidad y estilo.

## IT CINQUE MOTIVI PER SCEGLIERE DEDON

**PRODUZIONE PROPRIA**

Sia la fibra DEDON prodotta in Germania che i mobili realizzati nelle Filippine sono fabbricati in stabilimenti produttivi di proprietà dell'azienda – si tratta di una caratteristica unica nel settore degli arredi outdoor. L'arte artigiana si combina alla tecnologia più innovativa: i maestri tessitori nelle Filippine utilizzano fibre di elevatissima resistenza prodotte da DEDON.

#### LA MIGLIORE FIBRA DEL MONDO

Sia che si tratti del vento del deserto, dell'acqua salina o del gelo, la fibra DEDON è stata sottoposta a test di resistenza ai raggi UV per 10 anni. Prodotta in Germania dal nostro team di specialisti, essa non teme confronti in quanto a resistenza, tenuta dei colori durante il lavaggio e durata. E poiché la fibra DEDON viene prodotta completamente in-house, siamo in grado di lavorare direttamente con i nostri designer per creare soluzioni innovative, che si traducono in colori, tessuti e profili straordinari e unici.

#### I MATERIALI GIUSTI PER QUALSIASI AMBIENTAZIONE OUTDOOR

Da esperti specialisti in spazi living outdoor, DEDON seleziona sempre i materiali giusti per ogni ambientazione, dalle terrazze coperte ai bordi delle piscine, dalle spiagge agli ambienti naturali selvaggi. Questo è il motivo per cui, oltre ad offrire la fibra migliore del mondo, impieghiamo legno teak della qualità più pregiata, alluminio, tessuti, ceramiche e tappezzerie, tutto creato e realizzato con l'idea di raggiungere l'eccellenza.

#### SOSTENIBILITÀ

Fa parte della filosofia aziendale la missione che DEDON si è prefissata: produrre elementi d'arredo ed accessori di qualità talmente elevata da non dover mai essere gettati. Prodotta nei nostri stabilimenti a basso impatto ambientale nella Germania del nord, la fibra DEDON è riciclabile al 100% e priva di sostanze tossiche e di metalli pesanti. Inoltre, DEDON cerca di utilizzare materiale riciclato quando è possibile.

#### DESIGN

DEDON collabora con i più importanti designer del mondo, sia già affermati che emergenti, su collezioni che vengono spesso premiate con i più prestigiosi riconoscimenti internazionali nel campo del design. Il nostro centro studi e ricerca lavora costantemente a stretto contatto con i designer per definire le soluzioni e le innovazioni che contribuiscono a rendere i prodotti eccellenti in termini di qualità, funzionalità e stile.

## FR CINQ RAISONS DE CHOISIR DEDON

**UNE PRODUCTION MAISON**

La fabrication de la fibre DEDON en Allemagne, tout comme la production de meubles aux Philippines, se font dans nos propres sites de production – ce qui est unique dans le monde du mobilier d'extérieur. Quant l'artisanat se combine avec une technique innovante – les maîtres-tisserands de DEDON aux Philippines utilisent des fibres très résistantes, toutes issues de la production interne de DEDON.

#### LA MEILLEURE FIBRE AU MONDE

Que ce soit le vent du désert, l'eau salée ou le gel, la fibre DEDON est testée sous toutes les conditions climatiques et pour 10 ans de résistance aux UV. Produite en Allemagne par notre équipe de spécialistes, cette fibre a une solidité, une stabilité des couleurs et une longévité sans égal. Grâce à notre production exclusivement interne de la fibre DEDON, nous sommes en mesure de travailler avec des designers pour concevoir des solutions innovantes, des couleurs, des textures et des profils uniques.

#### LES MEILLEURS MATÉRIAUX POUR CHAQUE ENVIRONNEMENT

En tant que spécialiste des espaces de vie extérieure de tout type, DEDON sélectionne les matériaux appropriés à chaque environnement, que ce soit des terrasses ombragées aux piscines exposées en plein soleil, en passant par les plages de sable fin et la nature sauvage. C'est pourquoi nous combinons la meilleure fibre au monde avec du teck, de l'aluminium, des textiles tissés, de la céramique et du tissu d'ameublement de la plus haute qualité et produits avec la passion de l'excellence.

#### DURABILITÉ

La philosophie d'entreprise de DEDON consiste à produire des meubles et des accessoires d'une qualité telle qu'ils durent toute la vie. Élaborée dans nos sites de production respectueux de l'environnement dans le nord de l'Allemagne, la fibre DEDON est recyclable à 100% et sans polluants ni métaux lourds. De plus, DEDON intègre à ses produits des matériaux recyclés à chaque fois que cela est possible.

#### DESIGN

DEDON travaille avec les meilleurs designers au monde, aussi bien avec des grands noms qu'avec des étoiles montantes. Les collections qui en résultent remportent toujours les récompenses les plus prestigieuses en matière de design. Notre département interne de Recherche et Développement collabore étroitement avec chaque designer à l'élaboration de solutions et d'innovations qui font toute la différence en termes de qualité, de fonction et de style.







Art.No.: 88101865

International version

**DEDON GmbH**

Zeppelinstrasse 22  
21337 Lüneburg / Germany  
Tel. +49 41 31 / 22 44 70  
Fax +49 41 31 / 22 44 7 630  
info@dedon.de

**DEDON Asia Pacific Limited**

Hong Kong  
Tel. +852 / 3952 8787  
Fax +852 / 3952 8700  
office@dedon.hk

**DEDON Inc.**

657-C Brigham Road  
Greensboro, NC 27409  
(877) MY DEDON  
office@dedon.us

[www.dedon.de](http://www.dedon.de)