



T4G

6130-xxx

No. 87-006133-000 Revision A

TECHNICAL REFERENCE

Pentium® 4

or

Celeron®

PROCESSOR-BASED

SBC



WARRANTY

The product is warranted against material and manufacturing defects for two years from date of delivery. Buyer agrees that if this product proves defective Trenton Technology Inc. is only obligated to repair, replace or refund the purchase price of this product at Trenton Technology's discretion. The warranty is void if the product has been subjected to alteration, neglect, misuse or abuse; if any repairs have been attempted by anyone other than Trenton Technology Inc.; or if failure is caused by accident, acts of God, or other causes beyond the control of Trenton Technology Inc. Trenton Technology Inc. reserves the right to make changes or improvements in any product without incurring any obligation to similarly alter products previously purchased.

In no event shall Trenton Technology Inc. be liable for any defect in hardware or software or loss or inadequacy of data of any kind, or for any direct, indirect, incidental or consequential damages arising out of or in connection with the performance or use of the product or information provided. Trenton Technology Inc.'s liability shall in no event exceed the purchase price of the product purchased hereunder. The foregoing limitation of liability shall be equally applicable to any service provided by Trenton Technology Inc.

RETURN POLICY

Products returned for repair must be accompanied by a Return Material Authorization (RMA) number, obtained from Trenton Technology prior to return. Freight on all returned items must be prepaid by the customer, and the customer is responsible for any loss or damage caused by common carrier in transit. Items will be returned from Trenton Technology via Ground, unless prior arrangements are made by the customer for an alternative shipping method

To obtain an RMA number, call us at (800) 875-6031 or (770) 287-3100. We will need the following information:

Return company address and contact
Model name and model # from the label on the back of the board
Serial number from the label on the back of the board
Description of the failure

An RMA number will be issued. Mark the RMA number clearly on the outside of each box, include a failure report for each board and return the product(s) to our Utica, NY facility:

TRENTON Technology Inc.
1001 Broad Street
Utica, NY 13501
Attn: Repair Department

TRADEMARKS

IBM, PC, VGA, EGA, OS/2 and PS/2 are trademarks or registered trademarks of International Business Machines Corp.
AMI, AMIBIOS and AMIBIOS8 are trademarks or registered trademarks of American Megatrends Inc.
Intel and Pentium are registered trademarks of Intel Corporation.
MS-DOS and Microsoft are registered trademarks of Microsoft Corp.
PICMG and the PICMG logo are registered trademarks of the PCI Industrial Computer Manufacturers Group.
All other brand and product names may be trademarks or registered trademarks of their respective companies.

**LIABILITY
DISCLAIMER**

This manual is as complete and factual as possible at the time of printing; however, the information in this manual may have been updated since that time. Trenton Technology Inc. reserves the right to change the functions, features or specifications of their products at any time, without notice.

Copyright © 2003 by Trenton Technology Inc. All rights reserved.

E-mail: Support@TrentonTechnology.com

Web: www.TrentonTechnology.com



TRENTON Technology Inc.
2350 Centennial Drive • Gainesville, Georgia 30504
Sales: (800) 875-6031 • Phone: (770) 287-3100 • Fax: (770) 287-3150

Table of Contents

Before You Begin

| | |
|--|------------|
| Specifications | 1-1 |
| Introduction | 1-1 |
| Models | 1-1 |
| Features | 1-1 |
| SBC Block Diagram | 1-3 |
| SBC Board Layout | 1-4 |
| Processor | 1-5 |
| Bus Interfaces | 1-5 |
| Data Path | 1-5 |
| Bus Speed - ISA | 1-5 |
| Bus Speed - PCI | 1-5 |
| Bus Speed - System | 1-5 |
| Memory Interface | 1-5 |
| System Bus | 1-5 |
| DMA Channels | 1-5 |
| Interrupts | 1-5 |
| BIOS (Flash) | 1-5 |
| Cache Memory | 1-5 |
| NetBurst Micro-Architecture | 1-6 |
| DDR Memory | 1-6 |
| PCI Local Bus Interface | 1-7 |
| Universal Serial Bus (USB) | 1-7 |
| Video Interface | 1-7 |
| System Hardware Monitor | 1-8 |
| PCI Ethernet Interface | 1-8 |
| Hub Interface | 1-9 |
| PCI Enhanced IDE Interfaces (Dual) | 1-9 |
| Floppy Drive Interface | 1-9 |
| Serial Interface | 1-9 |
| Enhanced Parallel Interface | 1-9 |
| PS/2 Mouse Interface | 1-9 |
| Keyboard Interface | 1-9 |
| Watchdog Timer | 1-9 |
| Thermal Monitor | 1-10 |
| Power Fail Detection | 1-11 |
| Battery | 1-11 |

Table of Contents

Specifications (continued)

| | |
|---|------|
| Power Requirements | 1-11 |
| Temperature/Environment | 1-12 |
| Mean Time Between Failures (MTBF) | 1-12 |
| UL Recognition | 1-12 |
| Configuration Jumpers | 1-13 |
| Ethernet LEDs and Connectors | 1-14 |
| System BIOS Setup Utility | 1-15 |
| Connectors | 1-16 |

ISA/PCI Reference 2-1

| | |
|--|------|
| ISA Bus Pin Numbering | 2-1 |
| ISA Bus Pin Assignments | 2-2 |
| ISA Bus Signal Descriptions | 2-3 |
| I/O Address Map | 2-7 |
| Interrupt Assignments | 2-7 |
| PCI Local Bus Overview | 2-8 |
| PCI Local Bus Signal Definition | 2-9 |
| PCI Local Bus Pin Numbering | 2-10 |
| PCI Local Bus Pin Assignments | 2-11 |
| PCI Local Bus Signal Descriptions | 2-14 |
| PICMG Edge Connector Pin Assignments | 2-18 |

System BIOS 3-1

| | |
|---|------|
| BIOS Operation | 3-1 |
| Password Entry | 3-2 |
| BIOS Errors | 3-3 |
| Running AMIBIOS Setup | 3-5 |
| BIOS Setup Utility Main Menu | 3-6 |
| BIOS Setup Utility Options | 3-7 |
| Security Setup | 3-11 |
| Change Supervisor Password | 3-11 |
| Disabling Supervisor Password | 3-14 |
| Change User Password | 3-14 |
| Clear User Password | 3-14 |
| Boot Sector Virus Protection | 3-14 |
| Exit Menu | 3-17 |

Table of Contents

| | |
|---|------------|
| Advanced Setup | 4-1 |
| CPU Configuration | 4-5 |
| IDE Configuration | 4-7 |
| IDE Device Setup | 4-11 |
| Floppy Configuration | 4-15 |
| SuperIO Configuration | 4-17 |
| DMI Event Logging | 4-21 |
| Remote Access Configuration | 4-23 |
| USB Configuration | 4-25 |
| | |
| PCI Plug and Play Setup | 5-1 |
| | |
| Chipset Setup | 6-1 |
| Intel Brookdale-G NorthBridge Configuration | 6-3 |
| Intel ICH4 SouthBridge Configuration | 6-5 |
| | |
| Boot Setup | 7-1 |
| Boot Settings Configuration | 7-5 |
| Boot Device Priority | 7-9 |
| Hard Disk Drives | 7-11 |
| Removable Devices | 7-13 |
| ATAPI CDROM Drives | 7-15 |
| | |
| Appendix A - BIOS Messages | A-1 |
| BIOS Beep Codes | A-1 |
| BIOS Error Messages | A-2 |
| Bootblock Initialization Code Checkpoints | A-6 |
| Bootblock Recovery Code Checkpoints | A-7 |
| Post Code Checkpoints | A-8 |
| DIM Code Checkpoints | A-10 |
| Additional Checkpoints | A-11 |

This page intentionally left blank.

**HANDLING
PRECAUTIONS**

WARNING: This product has components which may be damaged by electrostatic discharge.

To protect your single board computer (SBC) from electrostatic damage, be sure to observe the following precautions when handling or storing the board:

- Keep the SBC in its static-shielded bag until you are ready to perform your installation.
- Handle the SBC by its edges.
- Do not touch the I/O connector pins. Do not apply pressure or attach labels to the SBC.
- Use a grounded wrist strap at your workstation or ground yourself frequently by touching the metal chassis of the system before handling any components. The system must be plugged into an outlet that is connected to an earth ground.
- Use antistatic padding on all work surfaces.
- Avoid static-inducing carpeted areas.

**SOLDER-SIDE
COMPONENTS**

This SBC has components on both sides of the PCB. It is important for you to observe the following precautions when handling or storing the board to prevent solder-side components from being damaged or broken off:

- Handle the board only by its edges.
- Store the board in padded shipping material or in an anti-static board rack.
- Do not place an unprotected board on a flat surface.

This page intentionally left blank.

Before you Begin

INTRODUCTION

It is important to be aware of the system considerations listed below before installing your T4G SBC. Overall system performance may be affected by incorrect usage of these features.

DDR MEMORY

The T4G requires that memory modules be non-ECC, unbuffered, non-stacked DIMMs. Memory modules can be installed in one or both DIMM sockets. If only one DIMM module is used, it should be populated in the top DIMM socket (Bank 2 - BK2). If two modules of different speeds are used, the 845GV chipset sets the memory interface speed to the speed of the slower DIMM module. Registered DIMMs are *not* supported. All memory modules must have gold contacts.

In addition, the DIMMs must have the following features:

- 184-pin with gold-plated contacts
- Non-ECC (64-bit) DDR memory
- Unbuffered configuration
- x8, x16 construction
- Non-stacked (NS)

NOTE: Intel's DDR memory interface design guidelines for the 845GV chipset validate the use of *non-stacked* DIMM modules. Therefore, the T4G, which uses the 845GV chipset, supports *only* non-stacked DIMMs in its standard system BIOS.

POWER REQUIREMENTS

The following are typical values:

| Processor | <u>+5V *</u> | <u>+12V **</u> | <u>+3.3V *</u> | <u>-12V *</u> |
|------------------------|--------------|----------------|----------------|---------------|
| Pentium® 4/533MHz FSB: | | | | |
| 2.8GHz | 3.01 Amps | 4.65 Amps | 2.01 Amps | < 100 mAmps |
| 2.4GHz | 2.95 Amps | 3.90 Amps | 1.99 Amps | < 100 mAmps |
| Pentium 4/400MHz FSB: | | | | |
| 2.6GHz | 2.95 Amps | 4.38 Amps | 2.00 Amps | < 100 mAmps |
| 2.0GHz | 2.95 Amps | 3.28 Amps | 2.00Amps | < 100 mAmps |
| Celeron®/400MHz FSB: | | | | |
| 2.0GHz | 2.85 Amps | 3.45 Amps | 1.98 Amps | < 100 mAmps |

* From backplane via PICMG connector.

** From ATX12V power supply or equivalent via P24 connector.

NOTE: The T4G requires an *additional* on-board power connector due to the power requirements of the Intel® Pentium® 4 processor. This 4-pin connector (P24) *requires* +12V from an external power supply that conforms to the ATX12V power specification. The external power supply *must* have a wattage rating of 250W or higher. The T4G also requires that +3.3V be applied to the backplane from the power supply.

**FOR MORE
INFORMATION**

For more information on any of these features, refer to the appropriate sections of the *T4G Technical Reference Manual* (#87-006133-000). The latest revision of this manual may be found on Trenton's website - www.TrentonTechnology.com.

Chapter 1 Specifications

INTRODUCTION

The T4G full-featured PCI/ISA processors are single board computers (SBCs) which feature the Intel® Pentium® 4 or Intel® Celeron® microprocessor, 400/533MHz system bus, Intel integrated video interface, up to 2GB DDR memory, PCI Local Bus, cache memory, floppy controller, dual EIDE (Ultra ATA/100) interfaces, 10/100Base-T Ethernet interface, two serial ports, parallel port, speaker port, mouse port and keyboard port on a single ISA-size card. These single-slot, high performance SBCs plug into PICMG® PCI/ISA backplanes and provide full PC compatibility for the system expansion slots.

MODELS

| <u>Model #</u> | <u>Model Name</u> | <u>Speed</u> |
|--|-------------------|--------------|
| Pentium 4 Processor - 533MHz FSB/512K cache: | | |
| 6130-107-xM | T4G/2.8 | 2.8GHz |
| 6130-106-xM | T4G/2.66 | 2.66GHz |
| 6130-105-xM | T4G/2.53 | 2.53GHz |
| 6130-104-xM | T4G/2.4 | 2.4GHz |
| 6130-103-xM | T4G/2.26 | 2.26GHz |
| Pentium 4 Processor - 400MHz FSB/512K cache: | | |
| 6130-006-xM | T4G/2.6 | 2.6GHz |
| 6130-005-xM | T4G/2.5 | 2.5GHz |
| 6130-004-xM | T4G/2.4A | 2.4GHz |
| 6130-003-xM | T4G/2.2 | 2.2GHz |
| 6130-002-xM | T4G/2.0A | 2.0GHz |
| 6130-001-xM | T4G/1.8A | 1.8GHz |
| Celeron Processor - 400MHz FSB/128K cache: | | |
| 6130-504-xM | T4G/2.2C | 2.2GHz |
| 6130-503-xM | T4G/2.1C | 2.1GHz |
| 6130-502-xM | T4G/2.0C | 2.0GHz |
| 6130-501-xM | T4G/1.8C | 1.8GHz |

where xM indicates memory size (0M = 0MB memory, 8M =8MB memory, etc.)

FEATURES

- Intel® Pentium® 4 microprocessor
 - 2.8GHz, 2.66GHz, 2.53GHz, 2.4GHz or 2.26GHz with 512K cache and a 533MHz Front Side Bus (FSB)
 - 2.6GHz, 2.5GHz, 2.4GHz, 2.2GHz, 2.0GHz or 1.8GHz with 512K cache and a 400MHz FSB
- or Intel® Celeron® microprocessor
 - 2.2GHz, 2.1GHz, 2.0GHz or 1.8GHz with 128K cache and a 400MHz FSB
- Intel 845GV chipset with 400/533MHz system bus
- PCI Local Bus operating in 32-bit/33MHz mode

**FEATURES
(CONTINUED)**

- Integrated on-board video interface provided by the Intel 845GV chipset
- PCI Local Bus supports off-board PCI option cards
- Compatible with PCI Industrial Computer Manufacturers Group (PICMG) 1.0 Specification
- Supports up to 2GB of Double Data Rate (DDR) on-board memory
- Floppy drive and dual PCI EIDE Ultra ATA/100 drive interfaces
- Two serial ports and one parallel port
- Dual Universal Serial Bus (USB 2.0) support
- Automatic or manual peripheral configuration
- Watchdog timer
- System hardware monitor
- Full PC compatibility

**SBC BLOCK
DIAGRAM**

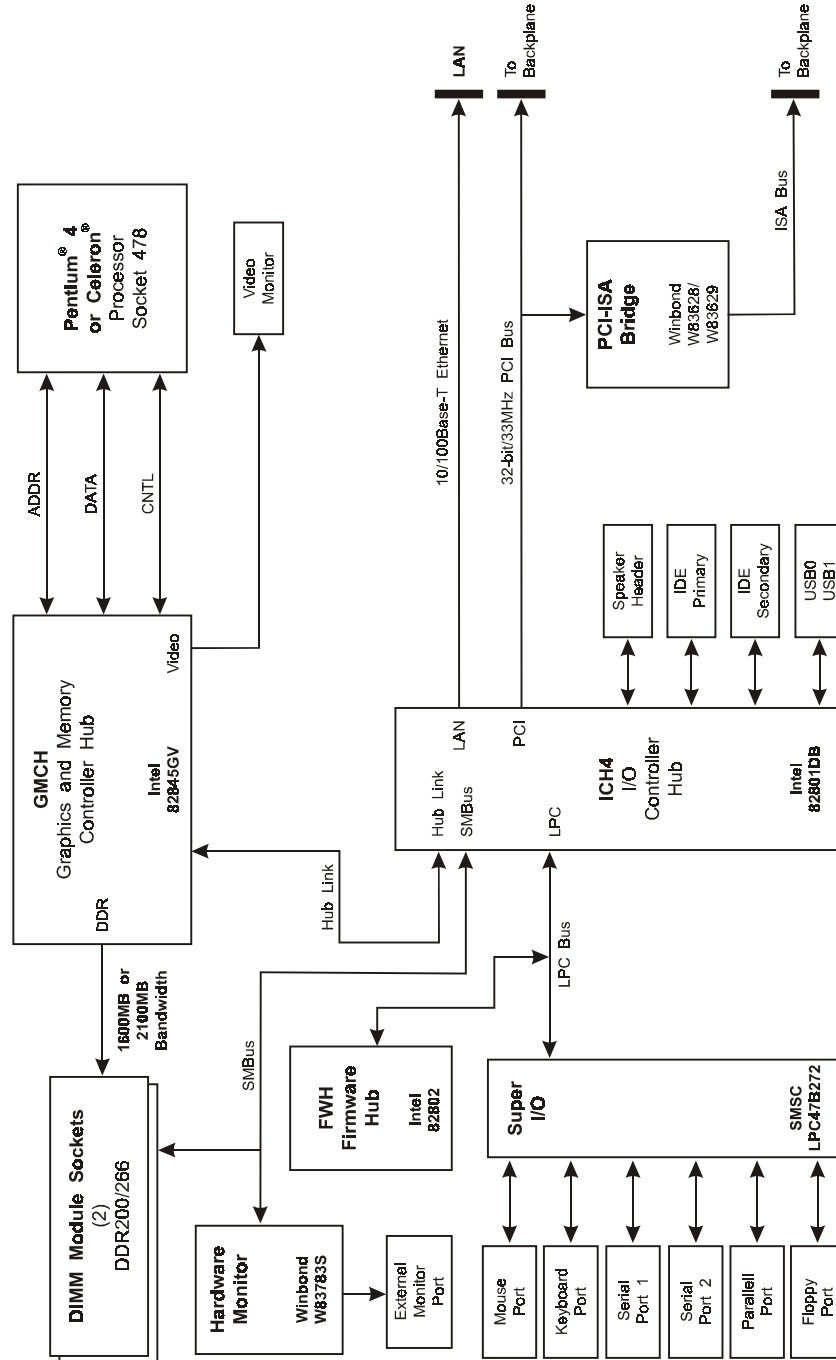

SBC BOARD LAYOUT

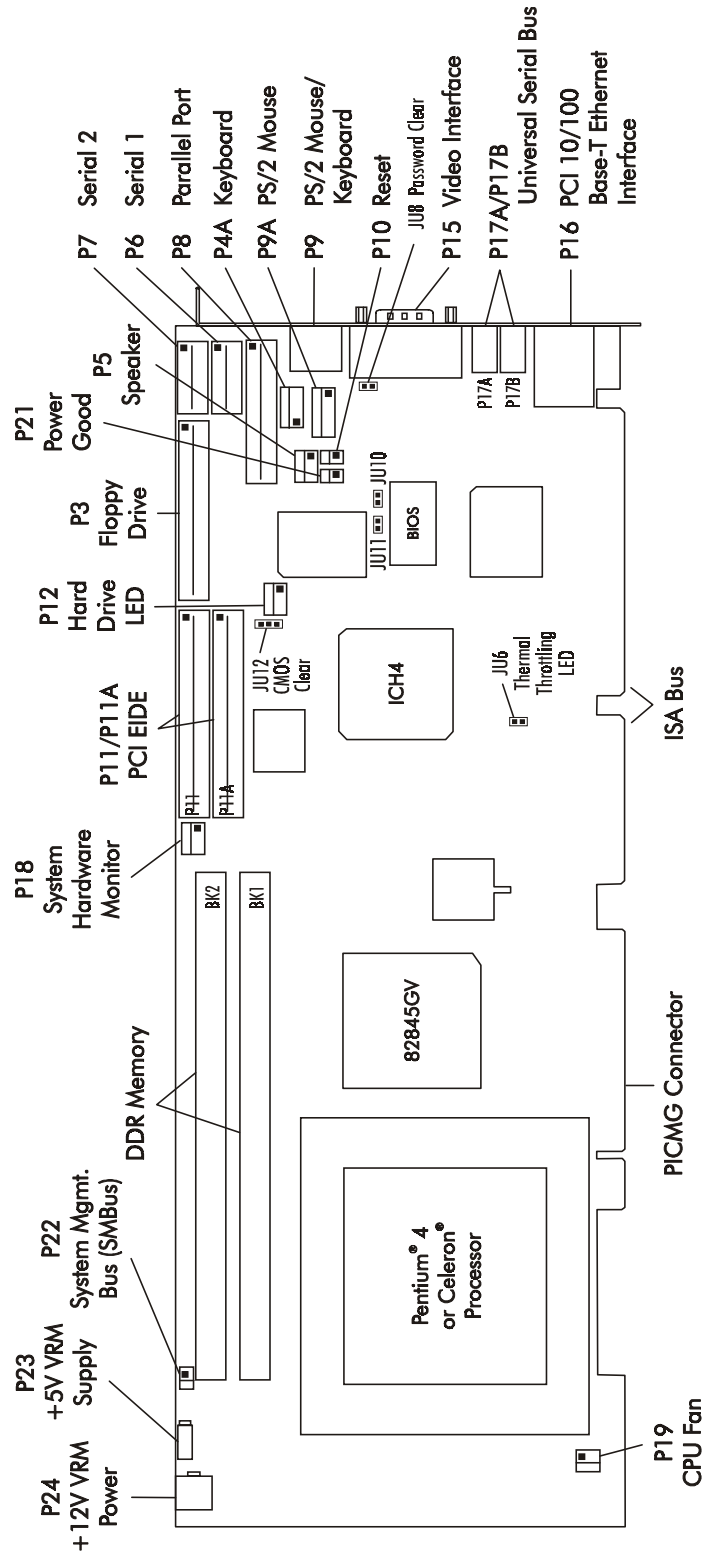

| | |
|---------------------------|---|
| PROCESSOR | <ul style="list-style-type: none"> Intel® Pentium® 4 microprocessor <ul style="list-style-type: none"> 2.8GHz, 2.66GHz, 2.53GHz, 2.4GHz or 2.26GHz with 512K cache and a 533MHz Front Side Bus (FSB) 2.6GHz, 2.5GHz, 2.4GHz, 2.2GHz, 2.0GHz or 1.8GHz with 512K cache and a 400MHz FSB or Intel® Celeron® microprocessor <ul style="list-style-type: none"> 2.2GHz, 2.1GHz, 2.0GHz or 1.8GHz with 128K cache and a 400MHz FSB Processor uses the mPGA 478 packaging |
| BUS INTERFACES | ISA and PCI Local Bus compatible |
| DATA PATH | <p>DDR Memory - 64-bit</p> <p>ISA Bus - 16-bit</p> <p>PCI Bus - 32-bit</p> <p>Video - 32-bit</p> |
| BUS SPEED - ISA | 8.33MHz |
| BUS SPEED - PCI | 33MHz |
| BUS SPEED - SYSTEM | 400/533MHz Front Side Bus |
| MEMORY INTERFACE | Double Data Rate (DDR) memory for 1600MB/s or 2100MB/s memory bandwidth |
| SYSTEM BUS | The Intel 845GV chipset supports the system bus at 400MHz or 533MHz, which provides a higher bandwidth path for transferring data between main memory/chipset and the processor. |
| DMA CHANNELS | The SBC is fully PC compatible with seven DMA channels, each supporting type F transfers. |
| INTERRUPTS | The SBC is fully PC compatible with interrupt steering for PCI plug and play compatibility. |
| BIOS (FLASH) | The BIOS is an AMIBIOS® with built-in advanced CMOS setup for system parameters, peripheral management for configuring on-board peripherals, PCI-to-PCI bridge support and PCI interrupt steering. The Flash BIOS resides in the Intel 82802 Firmware Hub (FWH). The BIOS may be upgraded from floppy disk by pressing <Ctrl> + <Home> immediately after reset or power-up with the floppy disk in drive A:. Custom BIOSs are available. |
| CACHE MEMORY | The Pentium 4 and Celeron processors include integrated on-die level two (L2) cache, which implements the Advanced Transfer Cache architecture. The Pentium 4 has 512K |

L2 cache; the Celeron has 128K L2 cache. The processors also includes a 12K level one (L1) Execution Trace Cache and 8K L1 data cache. These cache arrays run at the full speed of the processor core.

NETBURST™ MICRO- ARCHITECTURE

NetBurst micro-architecture defines the techniques Intel uses to enhance the processor's execution of the BIOS, operating system and application software. These techniques include hyper pipelined technology, a rapid execution engine, advanced dynamic execution, enhanced floating point and multimedia unit and Streaming SIMD Extensions 2 (SSE2). The processor's system bus speed and memory cache are also part of the NetBurst microarchitecture.

Hyper pipelined technology doubles the pipeline depth inside the processor, which enables more instructions to be loaded, resulting in higher core frequencies. Advanced dynamic execution includes an improved speculative execution algorithm that minimizes processor instruction misdirects and results in faster instruction execution.

The rapid execution engine enables the two arithmetic logic units (ALUs) of the processor to operate at twice the core frequency. Many integer instructions can now execute in half the internal core clock period, resulting in improved software execution speeds.

NetBurst micro-architecture improvements in the floating point and multimedia unit include making the registers 128 bits wide and adding a separate register for moving data.

The SSE2 has 144 instructions which improve performance in secure transactions and multimedia processing. These instructions are used for double-precision floating point, SIMD integer and memory management improvements.

DDR MEMORY

The Double Data Rate (DDR) memory interface consists of a single channel which terminates in two dual in-line memory module (DIMM) sockets and supports auto detection of up to 2GB of memory. The System BIOS automatically detects memory type, size and speed.

The SBC uses industry standard 64-bit wide gold finger PC1600 or PC2100 memory modules in 184-pin DIMM sockets.

NOTE: Memory modules can be installed in one or both DIMM sockets. If only one DIMM module is used, it should be populated in the top DIMM socket (Bank 2 - BK2). If two modules of different speeds are used, the 845GV chipset sets the memory interface speed to the speed of the slower DIMM module. Registered DIMMs are *not* supported. All memory modules must have gold contacts.

The SBC supports DIMMs which are PC1600/PC2100 compliant and have the following features:

- 184-pin with gold-plated contacts
- Non-ECC (64-bit) DDR memory
- Unbuffered configuration

- x8, x16 construction
- Non-stacked (NS)

NOTE: Intel's DDR memory interface design guidelines for the 845GV chipset validate the use of *non-stacked* DIMM modules. Therefore, the T4G, which uses the 845GV chipset, supports *only* non-stacked DIMMs in its standard system BIOS.

The following DIMM sizes are supported:

| <u>DIMM Size</u> | <u>DIMM Type</u> | <u>Non-ECC</u> | <u>Component Construction</u> |
|------------------|------------------|----------------|-------------------------------|
| 64MB | Unbuffered | 8M x 64 | x8, x16, NS |
| 128MB | Unbuffered | 16M x 64 | x8, x16, NS |
| 256MB | Unbuffered | 32M x 64 | x8, x16, NS |
| 512MB | Unbuffered | 64M x 64 | x8, x16, NS |
| 1GB | Unbuffered | 128M x 64 | x8, x16, NS |

PCI LOCAL BUS INTERFACE

The SBC is fully compliant with the PCI Local Bus 2.1 Specification. The PCI Local Bus is 32 bits wide and runs at 33MHz. It interfaces to standard PCI option cards in the backplane and to the on-board PCI-to-ISA bridge interface. The PCI Local Bus interface to the backplane is compliant with the PCI Industrial Computer Manufacturers Group (PICMG) 1.0 Specification.

UNIVERSAL SERIAL BUS (USB)

The SBC supports two high-speed USB 2.0 ports for data transfers up to 480Mbit/sec. It also supports USB 1.1 devices for data transfers at 12 or 1.5Mbit/sec. The Universal Serial Bus (USB) is an interface allowing for connectivity to many standard PC peripherals via an external port.

VIDEO INTERFACE

The analog video interface of the 845GV supports pixel resolutions up to 2048 x 1536 (QXGA) at a refresh rate of 60Hz. The graphics and memory controller hub (GMCH) of the 845GV has an integrated graphics accelerator that supports high performance 3D/2D graphics and video.

The amount of system memory used for video is determined by the SBC's BIOS and by the 845GV's Dynamic Video Memory Technology (DVMT) feature. In the BIOS, the user can allocate up to 8MB of system memory to support video; DVMT can dynamically allocate up to 64MB. DVMT memory allocations take the form of allocation requests from the graphics driver to the operating system based on the needs of the application software. DVMT returns the memory to the operating system when the application no longer needs the additional video memory support. The specific amount of system memory used by the chipset's integrated video interface depends on the pixel resolution, color depth setting and graphic demands of the application.

Software drivers for enhanced performance and resolution are available for most popular operating systems.

**SYSTEM
HARDWARE
MONITOR**

The system hardware monitoring system monitors system voltages, temperature and fan speeds.

The circuitry is based on Winbond's W83783S hardware monitoring IC that is interfaced via the system's SMBus. System voltages of +12V, +5V, +3.3V, +2.5V, VCCORE (processor voltage) and -12V are monitored. Each of these six voltages has programmable "high" and "low" watchdog limits. Also monitored are the processor die temperature and the fan speed associated with the processor's active heatsink thermal solution. Programmable watchdog limits are also associated with fan speed RPMs. When any of these programmed limits are exceeded, monitor software can be used to report the out-of-limit condition.

The System Hardware Monitor connector (P18) provides an external interface for user functionality. Pin assignments for this connector are as follows:

| <u>Pin #/Definition</u> | <u>Description</u> |
|-------------------------|--|
| Pin 1 - GND | System Ground |
| Pin 2 - GPO | General Purpose Output Active low open drain output. This multi-function output is controlled by the W38383S's configuration register at offset 40(h) and the control register at 4D(h). It can be used as a general-purpose output or programmed to provide a beep function that can be used as a watchdog warning signal. This output is open drain. |
| Pin 3 - CI | Chassis Intrusion Input Active low input from an external circuit, which can be used to indicate a chassis intrusion event. This input line is connected directly to the ICH's System Management Interface's INTRUDER# input. It can be set to disable the system if the chassis is open or can be used as a general-purpose input if intruder detection is not used. |
| Pin 4 - OVT | Over Temperature This active low, open drain output can be used to indicate that an over-temperature condition exists. |

**PCI ETHERNET
INTERFACE**

The PCI Ethernet interface is implemented using an Intel 82562ET 10/100Base-T Ethernet controller which supports 10Base-T and 100Base-TX Fast Ethernet modes. The interface is compliant with IEEE 802.3.

The main components of this interface are:

- Intel 82801DB for 10/100-Mb/s media access control (MAC), a serial ROM port and a PCI Bus Master interface

- Intel 82562ET 10/100-Mb/s PHY
- Serial ROM for storing the Ethernet address and the interface configuration and control data
- Integrated RJ-45/Magnetics module connector on the SBC's I/O bracket for direct connection to the network. The connector requires a category 5 (CAT5) unshielded twisted-pair (UTP) 2-pair cable for a 100-Mb/s network connection or a category3 (CAT3) or higher UTP 2-pair cable for a 10-Mb/s network connection.
- Link status and activity LEDs on the I/O bracket for status indication (See *Ethernet LEDs and Connectors* later in this chapter.)

Software drivers are supplied for most popular operating systems.

| | |
|---|--|
| HUB INTERFACE | The 845GV chipset utilizes a dedicated hub interface connection between the 845GV graphics and memory controller hub (GMCH) and the I/O controller hub (ICH4). The purpose of the 845GV hub interface is to provide efficient, high-speed communication between chipset components in order to support high-speed I/O applications. It is a parity-protected, 266MB/s point-to-point hub interface and uses an 8-bit 66MHz base clock running at 4x. |
| PCI ENHANCED IDE INTERFACES (DUAL) | Dual high performance PCI Bus Master EIDE interfaces are capable of supporting two IDE disk drives each in a master/slave configuration. The interfaces support Ultra ATA/100 with synchronous ATA mode transfers up to 100MB per second. Ultra ATA/100 cables must be used with Ultra ATA/100 drives. |
| FLOPPY DRIVE INTERFACE | The SBC supports two floppy disk drives. Drives can be 360K to 2.88MB, in any combination. |
| SERIAL INTERFACE | Two high-speed FIFO (16C550) serial ports with independently programmable baud rates are supported. The IRQ for each serial port has BIOS selectable addressing. |
| ENHANCED PARALLEL INTERFACE | The SBC provides a PC/AT compatible bidirectional parallel port and supports enhanced parallel port (EPP) mode and extended capabilities port (ECP) mode. The ECP mode is IEEE 1284 compliant. The IRQ for the parallel port has BIOS selectable addressing. |
| PS/2 MOUSE INTERFACE | The SBC is compatible with a PS/2-type mouse. The mouse connection can be made by using either the PS/2 mouse header or the bracket mounted mouse/keyboard mini DIN connector. The mouse may be connected directly to the mini DIN connector or to the "mouse" side of the "Y" adapter. Mouse voltage is protected by a self-resetting fuse. |
| KEYBOARD INTERFACE | The SBC is compatible with an AT-type keyboard. The keyboard connection can be made by using either the keyboard header or the "keyboard" side of the "Y" adapter plugged into the bracket mounted mouse/keyboard mini DIN connector. Keyboard voltage is protected by a self-resetting fuse. |
| WATCHDOG TIMER | The watchdog timer is a hardware timer which resets the SBC if the timer is not refreshed by software periodically. The timer is typically used to restart a system in which an application becomes hung on an external event. When the application is hung, it no longer refreshes the timer. The watchdog timer then times out and resets the SBC. |

The watchdog timer has programmable timeout periods of 30 mseconds, 10 seconds or 60 seconds. When enabled, the watchdog timer generates a system reset by deactivating the Power Good signal. Watchdog timer control is supplied via the ICH4 General Purpose I/O pins. The state of these GPIO signals are controlled by the GPIO Level Input or Output Register (GP_LVL). This 32-bit register is located at offset 0C(h) in the General Purpose I/O space at base address 500(h). Bits 19, 20 and 23 of this register are used for watchdog timer control. The register can also be accessed in byte mode; bits 23-16 reside at I/O address 50E(h).

The GP_LVL bit definitions are as follows:

Bit 19 - Watchdog Input (WDI)

When the watchdog timer is enabled, this bit must be toggled (0 to 1 or 1 to 0) within the selected watchdog timeout period. Failure to do so results in a system reset. This function is controlled by bit 19 of the GP_LVL register.

Bits 20 and 23 - Watchdog Select 0/Watchdog Select 1 (WDS0/WDS1)

These two bits of the GP_LVL register select the watchdog timeout period.

Timeout period options are as follows:

| <u>WDS1</u> | <u>WDS0</u> | <u>Timeout Period</u> |
|-------------|-------------|-----------------------------|
| 0 | 0 | 30 mseconds |
| 0 | 1 | Disabled (power-on default) |
| 1 | 0 | 10 seconds |
| 1 | 1 | 60 seconds |

The Watchdog Input (WDI) bit should be toggled immediately prior to changing the timeout period. Once the WDS1 and WDS0 bits have been set to select the desired timeout period, the WDI bit must be toggled within the selected period.

A set of watchdog timer software code and sample programs are available from Technical Support.

THERMAL MONITOR The SBC's processor has a built-in thermal monitor feature designed to prevent processor failure at elevated operating temperature. The thermal monitor consists of an on-die temperature sensor and a fast-acting thermal control circuit (TCC).

The actual TCC activation point in a specific SBC application may vary as a function of processor loading, system case design, SBC location within a case and other factors. When the TCC activates, the SBC's Thermal Throttling Activity LED turns on. Depending on the setting of the Thermal Throttling Activity LED jumper (JU6), the LED either goes off after the processor returns to normal temperature or remains on in a latched state to indicate that the processor's TCC has activated at least once. (See the *Configuration Jumpers* section later in this chapter for further explanation of the Thermal Throttling Activity LED jumper.)

Under normal operating conditions, the SBC's active cooling system generally prevents the TCC from activating.

**POWER FAIL
DETECTION**

A hardware reset is issued when any of the monitored voltages drops below its specified nominal low voltage limit.

The monitored voltages and their nominal low limits are listed below:

| <u>Monitored Voltage</u> | <u>Nominal Low Limit</u> | <u>Voltage Source</u> |
|--------------------------|--------------------------|-----------------------|
| +5V | 4.5 volts | System Power Supply |
| +3.3V | 2.97 volts | System Power Supply |
| +1.2V | 1.056 volts | On-Board Regulator |
| +1.25V | 1.1 volt | On-Board Regulator |
| +2.5V | 2.452 volts | On-Board Regulator |

BATTERY

A built-in lithium battery is provided, for ten years of data retention for CMOS memory.

CAUTION: There is a danger of explosion if the battery is incorrectly replaced. Replace it only with the same or equivalent type recommended by the manufacturer. Dispose of used batteries according to the manufacturer's instructions.

**POWER
REQUIREMENTS**

The following are typical values:

| <u>Processor Speed</u> | <u>+5V *</u> | <u>+12V **</u> | <u>+3.3V *</u> | <u>-12V *</u> |
|------------------------------|--------------|----------------|----------------|---------------|
| Pentium 4/533MHz FSB: | | | | |
| 2.8GHz | 3.01 Amps | 4.65 Amps | 2.01 Amps | < 100 mAmps |
| 2.4GHz | 2.95 Amps | 3.90 Amps | 1.99 Amps | < 100 mAmps |
| Pentium 4/400MHz FSB: | | | | |
| 2.6GHz | 2.95 Amps | 4.38 Amps | 2.00 Amps | < 100 mAmps |
| 2.0GHz | 2.95 Amps | 3.28 Amps | 2.00Amps | < 100 mAmps |
| Celeron/400MHz FSB: | | | | |
| 2.0GHz | 2.85 Amps | 3.45 Amps | 1.98 Amps | < 100 mAmps |

* From backplane via PICMG connector.
 ** From ATX12V power supply or equivalent via P24 connector.

NOTE: The T4G requires an *additional* on-board power connector due to the power requirements of the Intel® Pentium® 4 processor. This 4-pin connector (P24) *requires* +12V from an external power supply that conforms to the ATX12V power specification. The external power supply *must* have a wattage rating of 250W or higher. The T4G also requires that +3.3V be applied to the backplane from the power supply.

**TEMPERATURE/
ENVIRONMENT****Operating Temperature:** 0° C. to 45° C.**Storage Temperature:** - 40° C. to 70° C.**Humidity:** 5% to 90% non-condensing**MEAN TIME
BETWEEN
FAILURES (MTBF)**

157,000 POH (Power-On Hours) at 40° C., per Bellcore

UL RECOGNITION

This SBC is a UL recognized product listed in file #E208896.

This board was investigated and determined to be in compliance under the Bi-National Standard for Information Technology Equipment. This included the Electrical Business Equipment, UL 1950, Third Edition, and CAN/CSA C22.22 No. 950-95.

CONFIGURATION JUMPERS

The setup of the configuration jumpers on the SBC is described below. * indicates the default value of each jumper.

NOTE: For two-position jumpers (3-post), "TOP" is toward the memory sockets; "BOTTOM" is toward the edge fingers.

| <u>Jumper</u> | <u>Description</u> | | | | | | | | | | | | |
|----------------------------|--|-------------|-------------|-------------|--------------------------|----------|----------|----------------------------|---------|--------|----------------------------|--------|---------|
| JU6 | <p>Thermal Throttling Activity LED</p> <p>If the processor core gets to a critical temperature, it slows itself down to half its normal speed. This jumper sets the way in which the LED displays in response to this self-limiting mode.</p> <p>Install for real-time activity. The LED lights only when the processor is operating in slow-power mode. *</p> <p>Remove for latched activity. The LED lights and stays on once the processor has gone into slow-power mode.</p> | | | | | | | | | | | | |
| JU8 | <p>Password Clear</p> <p>Install for one power-up cycle to reset the password to the default (null password). Remove for normal operation. *</p> | | | | | | | | | | | | |
| JU10/JU11 | <p>System Flash ROM Operational Modes</p> <p>The Flash ROM has two programmable sections: the Boot Block for “flashing” in the BIOS and the Main Block for the executable BIOS and PnP parameters. Normally only the Main Block is updated when a new BIOS is flashed into the system.</p> <table border="0" style="margin-left: auto; margin-right: auto;"> <thead> <tr> <th></th> <th style="text-align: center;"><u>JU10</u></th> <th style="text-align: center;"><u>JU11</u></th> </tr> </thead> <tbody> <tr> <td>All Blocks Write Enabled</td> <td style="text-align: center;">Remove *</td> <td style="text-align: center;">Remove *</td> </tr> <tr> <td>Boot Block Write Protected</td> <td style="text-align: center;">Install</td> <td style="text-align: center;">Remove</td> </tr> <tr> <td>Block 2-16 Write Protected</td> <td style="text-align: center;">Remove</td> <td style="text-align: center;">Install</td> </tr> </tbody> </table> | | <u>JU10</u> | <u>JU11</u> | All Blocks Write Enabled | Remove * | Remove * | Boot Block Write Protected | Install | Remove | Block 2-16 Write Protected | Remove | Install |
| | <u>JU10</u> | <u>JU11</u> | | | | | | | | | | | |
| All Blocks Write Enabled | Remove * | Remove * | | | | | | | | | | | |
| Boot Block Write Protected | Install | Remove | | | | | | | | | | | |
| Block 2-16 Write Protected | Remove | Install | | | | | | | | | | | |

**CONFIGURATION
JUMPERS
(CONTINUED)**

| <u>Jumper</u> | <u>Description</u> |
|---------------|--------------------|
| JU12 | CMOS Clear |

Install on the TOP to operate. *
Install on the BOTTOM to clear.

NOTE: The CMOS Clear jumper works on power-up. To clear the CMOS, power down the system, install the jumper, then turn the power back on. Wait for at least two seconds and turn the power off. Then remove the jumper and turn the power on. When AMIBIOS displays the "CMOS Settings Wrong" message, press F1 to go into the BIOS Setup Utility, where you may reenter your desired BIOS settings, load optimal defaults or load failsafe defaults.

**ETHERNET LEDs
AND CONNECTORS**

The Ethernet interface is implemented using the integrated LAN controller in the Intel 82801DB (ICH4) and its companion Intel 82562ET 10/100Base-T Ethernet PHY which supports 10Base-T and 100Base-TX Fast Ethernet modes. The interface has two LEDs for status indication and an RJ-45 network connector..

| <u>LED/Connector</u> | <u>Description</u> |
|----------------------|--------------------|
|----------------------|--------------------|

| | |
|-------------------|--|
| Link/Activity LED | Green LED which indicates the link status. |
|-------------------|--|

| | |
|-----|--|
| Off | The Ethernet interface did not find a valid link on the network connection. Transmit and receive are not possible. |
|-----|--|

| | |
|------------|---|
| On (solid) | The Ethernet interface has a valid link on the network connection and is ready for normal operation. The Speed LED identifies connection speed. |
|------------|---|

| | |
|---------------|---|
| On (flashing) | Indicates network transmit or receive activity. |
|---------------|---|

| | |
|-----------|--|
| Speed LED | Amber LED which identifies connection speed. |
|-----------|--|

| | |
|-----|---------------------------------|
| Off | Indicates a 10-Mb/s connection. |
|-----|---------------------------------|

| | |
|----|----------------------------------|
| On | Indicates a 100-Mb/s connection. |
|----|----------------------------------|

| | |
|-------------------------|---|
| RJ-45 Network Connector | The RJ-45 network connector requires a category 5 (CAT5) unshielded twisted-pair (UTP) 2-pair cable for a 100-Mb/s network connection or a category 3 (CAT3) or higher UTP 2-pair cable for a 10-Mb/s network connection. |
|-------------------------|---|

**SYSTEM BIOS
SETUP UTILITY**

The System BIOS is an AMIBIOS with a ROM-resident setup utility. The BIOS Setup Utility allows you to select to the following categories of options:

- Main Menu
- Advanced Setup
- PCIPnP Setup
- Chipset Setup
- Boot Setup
- Security Setup
- Exit

Each of these options allows you to review and/or change various setup features of your system. Details are provided in the following chapters of this manual.

CONNECTORS

NOTE: Pin 1 on the connectors is indicated by the square pad on the PCB.

P3 - Floppy Drive Connector

34 pin dual row header, Amp #103308-7

| <u>Pin</u> | <u>Signal</u> | <u>Pin</u> | <u>Signal</u> |
|------------|---------------|------------|-----------------|
| 1 | Gnd | 2 | N-RPM |
| 3 | Gnd | 4 | NC |
| 5 | Gnd | 6 | D-Rate0 |
| 7 | Gnd | 8 | P-Index |
| 9 | Gnd | 10 | N-Motoron 1 |
| 11 | Gnd | 12 | N-Drive Sel2 |
| 13 | Gnd | 14 | N-Drive Sel1 |
| 15 | Gnd | 16 | N-Motoron 2 |
| 17 | Gnd | 18 | N-Dir |
| 19 | Gnd | 20 | N-Stop Step |
| 21 | Gnd | 22 | N-Write Data |
| 23 | Gnd | 24 | N-Write Gate |
| 25 | Gnd | 26 | P-Track 0 |
| 27 | Gnd | 28 | P-Write Protect |
| 29 | Gnd | 30 | N-Read Data |
| 31 | Gnd | 32 | N-Side Select |
| 33 | Gnd | 34 | Disk Chng |

P4A - Keyboard Header

5 pin single row header, Amp #640456-5

| <u>Pin</u> | <u>Signal</u> |
|------------|--|
| 1 | Kbd Clock |
| 2 | Kbd Data |
| 3 | Key |
| 4 | Kbd Gnd |
| 5 | Kbd Power (+5V fused) with self-resetting fuse |

P5 - Speaker Port Connector

4 pin single row header, Amp #640456-4

| <u>Pin</u> | <u>Signal</u> |
|------------|---------------|
| 1 | Speaker Data |
| 2 | Key |
| 3 | Gnd |
| 4 | +5V |

**CONNECTORS
(CONTINUED)**

- P6 - Serial Port 1 Connector**
10 pin dual row header, Amp #103308-1

| <u>Pin</u> | <u>Signal</u> | <u>Pin</u> | <u>Signal</u> |
|------------|-----------------------|------------|-------------------|
| 1 | Carrier Detect | 2 | Data Set Ready-I |
| 3 | Receive Data-I | 4 | Request to Send-O |
| 5 | Transmit Data-O | 6 | Clear to Send-I |
| 7 | Data Terminal Ready-O | 8 | Ring Indicator-I |
| 9 | Signal Gnd | 10 | NC |

- P7 - Serial Port 2 Connector**
10 pin dual row header, Amp #103308-1

| <u>Pin</u> | <u>Signal</u> | <u>Pin</u> | <u>Signal</u> |
|------------|-----------------------|------------|-------------------|
| 1 | Carrier Detect | 2 | Data Set Ready-I |
| 3 | Receive Data-I | 4 | Request to Send-O |
| 5 | Transmit Data-O | 6 | Clear to Send-I |
| 7 | Data Terminal Ready-O | 8 | Ring Indicator-I |
| 9 | Signal Gnd | 10 | NC |

- P8 - Parallel Port Connector**
26 pin dual row header, Amp #103308-6

| <u>Pin</u> | <u>Signal</u> | <u>Pin</u> | <u>Signal</u> |
|------------|---------------|------------|---------------|
| 1 | Strobe | 2 | Auto Feed XT |
| 3 | Data Bit 0 | 4 | Error |
| 5 | Data Bit 1 | 6 | Init |
| 7 | Data Bit 2 | 8 | Slct In |
| 9 | Data Bit 3 | 10 | Gnd |
| 11 | Data Bit 4 | 12 | Gnd |
| 13 | Data Bit 5 | 14 | Gnd |
| 15 | Data Bit 6 | 16 | Gnd |
| 17 | Data Bit 7 | 18 | Gnd |
| 19 | ACK | 20 | Gnd |
| 21 | Busy | 22 | Gnd |
| 23 | Paper End | 24 | Gnd |
| 25 | Slct | 26 | NC |

- P9 - PS/2 Mouse and Keyboard Connector**
6 pin mini DIN, Kycon #KMDG-6S-B4T

| <u>Pin</u> | <u>Signal</u> |
|------------|--|
| 1 | Ms Data |
| 2 | Kbd Data |
| 3 | Gnd |
| 4 | Power (+5V fused) with self-resetting fuse |
| 5 | Ms Clock |
| 6 | Kbd Clock |

**CONNECTORS
(CONTINUED)**

P9A - PS/2 Mouse Header
6 pin single row header, Amp #640456-6

| <u>Pin</u> | <u>Signal</u> |
|------------|--|
| 1 | Ms Data |
| 2 | Reserved |
| 3 | Gnd |
| 4 | Power (+5V fused) with self-resetting fuse |
| 5 | Ms Clock |
| 6 | Reserved |

P10 - External Reset Connector
2 pin single row header, Amp #640456-2

| <u>Pin</u> | <u>Signal</u> |
|------------|--------------------------------|
| 1 | External Reset In (Low Active) |
| 2 | Gnd |

P11 - Primary IDE Hard Drive Connector
40 pin dual row header, 3M #30340-6002HB

| <u>Pin</u> | <u>Signal</u> | <u>Pin</u> | <u>Signal</u> |
|------------|---------------|------------|---------------|
| 1 | Reset | 2 | Gnd |
| 3 | Data 7 | 4 | Data 8 |
| 5 | Data 6 | 6 | Data 9 |
| 7 | Data 5 | 8 | Data 10 |
| 9 | Data 4 | 10 | Data 11 |
| 11 | Data 3 | 12 | Data 12 |
| 13 | Data 2 | 14 | Data 13 |
| 15 | Data 1 | 16 | Data 14 |
| 17 | Data 0 | 18 | Data 15 |
| 19 | Gnd | 20 | NC |
| 21 | DRQ 0 | 22 | Gnd |
| 23 | IOW | 24 | Gnd |
| 25 | IOR | 26 | Gnd |
| 27 | IRDY | 28 | SELPDP |
| 29 | DACK 0 | 30 | Gnd |
| 31 | IRQ 14 | 32 | NC |
| 33 | Add 1 | 34 | PCBL DET * |
| 35 | Add 0 | 36 | Add 2 |
| 37 | CS 1P | 38 | CS 3P |
| 39 | IDEACTP | 40 | Gnd |

* For ATA/66 and ATA/100 drives, which should be set for Cable Select for proper speed operation. If other drives are detected, pin definition is Gnd.

**CONNECTORS
(CONTINUED)****P11A - Secondary IDE Hard Drive Connector**
40 pin dual row header, 3M #30340-6002HB

| <u>Pin</u> | <u>Signal</u> | <u>Pin</u> | <u>Signal</u> |
|------------|---------------|------------|---------------|
| 1 | Reset | 2 | Gnd |
| 3 | Data 7 | 4 | Data 8 |
| 5 | Data 6 | 6 | Data 9 |
| 7 | Data 5 | 8 | Data 10 |
| 9 | Data 4 | 10 | Data 11 |
| 11 | Data 3 | 12 | Data 12 |
| 13 | Data 2 | 14 | Data 13 |
| 15 | Data 1 | 16 | Data 14 |
| 17 | Data 0 | 18 | Data 15 |
| 19 | Gnd | 20 | NC |
| 21 | DRQ 1 | 22 | Gnd |
| 23 | IOW | 24 | Gnd |
| 25 | IOR | 26 | Gnd |
| 27 | IRDY | 28 | SELPDS |
| 29 | DACK 1 | 30 | Gnd |
| 31 | IRQ 15 | 32 | NC |
| 33 | Add 1 | 34 | SCBL DET * |
| 35 | Add 0 | 36 | Add 2 |
| 37 | CS 1S | 38 | CS 3S |
| 39 | IDEACTS | 40 | Gnd |

* For ATA/66 and ATA/100 drives, which should be set for Cable Select for proper speed operation. If other drives are detected, pin definition is Gnd.

P12 - Hard Drive LED Connector
4 pin single row header, Amp #640456-4

| <u>Pin</u> | <u>Signal</u> |
|------------|---------------|
| 1 | LED + |
| 2 | LED - |
| 3 | LED - |
| 4 | LED + |

P15 - Video Interface Connector
15 pin HD15 connector, Amp #1-1470250-3

| <u>Pin</u> | <u>Signal</u> | <u>Pin</u> | <u>Signal</u> |
|------------|---------------|------------|---------------|
| 1 | Red | 6 | Gnd |
| 2 | Green | 7 | Gnd |
| 3 | Blue | 8 | Gnd |
| 4 | NC | 9 | +5V |
| 5 | Gnd | 10 | Gnd |
| | | 11 | NC |
| | | 12 | EEDI |
| | | 13 | HSYNC |
| | | 14 | VSYNC |
| | | 15 | EECS |

**CONNECTORS
(CONTINUED)**

- P16 - 10/100Base-T Ethernet Connector**
8 pin shielded RJ-45 connector, Pulse #J0035D21B

| <u>Pin</u> | <u>Signal</u> |
|------------|---------------|
| 1 | TD+ |
| 2 | TD- |
| 3 | RX+ |
| 4 | NC |
| 5 | NC |
| 6 | RX- |
| 7 | NC |
| 8 | NC |

- P17A - Universal Serial Bus (USB) Connector**
4 pin USB vertical connector, Molex #67329-0000
(+5V over current protection)

| <u>Pin</u> | <u>Signal</u> |
|------------|---------------|
| 1 | +5V-USB0 |
| 2 | USB0- |
| 3 | USB0+ |
| 4 | Gnd-USB0 |

- P17B - Universal Serial Bus (USB) Connector**
4 pin USB vertical connector, Molex #67329-0000
(+5V over current protection)

| <u>Pin</u> | <u>Signal</u> |
|------------|---------------|
| 1 | +5V-USB1 |
| 2 | USB1- |
| 3 | USB1+ |
| 4 | Gnd-USB1 |

- P18 - System Hardware Monitor Connector**
4 pin single row header, Amp #640456-4

| <u>Pin</u> | <u>Signal</u> |
|------------|------------------------------|
| 1 | Gnd |
| 2 | GPO (General Purpose Output) |
| 3 | CI (Chassis Intrusion Input) |
| 4 | OVT (Over Temperature) |

- P19 - CPU Fan**
3 pin single row header, Molex #22-23-2031

| <u>Pin</u> | <u>Signal</u> |
|------------|---------------|
| 1 | Gnd |
| 2 | +12V |
| 3 | FanTach |

**CONNECTORS
(CONTINUED)**

P21 - Power Good LED
2 pin single row header, Amp #640456-2

| <u>Pin</u> | <u>Signal</u> |
|------------|---------------|
| 1 | LED - |
| 2 | LED + |

P22 - System Management Bus Connector
2 pin single row header, Amp #640456-2

| <u>Pin</u> | <u>Signal</u> |
|------------|---------------|
| 1 | SMB Clock |
| 2 | SMB Data |

P23 - +5V VRM Supply
2 pin header, Molex #39-29-3026

| <u>Pin</u> | <u>Signal</u> |
|------------|---------------|
| 1 | +5V |
| 2 | +5V |

P24 - +12V VRM Power Input
4 pin header, Molex #39-29-3046

| <u>Pin</u> | <u>Signal</u> |
|------------|---------------|
| 1 | Gnd |
| 2 | Gnd |
| 3 | +12V |
| 4 | +12V |

This page intentionally left blank.

Chapter 2 *ISA/PCI Reference*

ISA BUS PIN NUMBERING

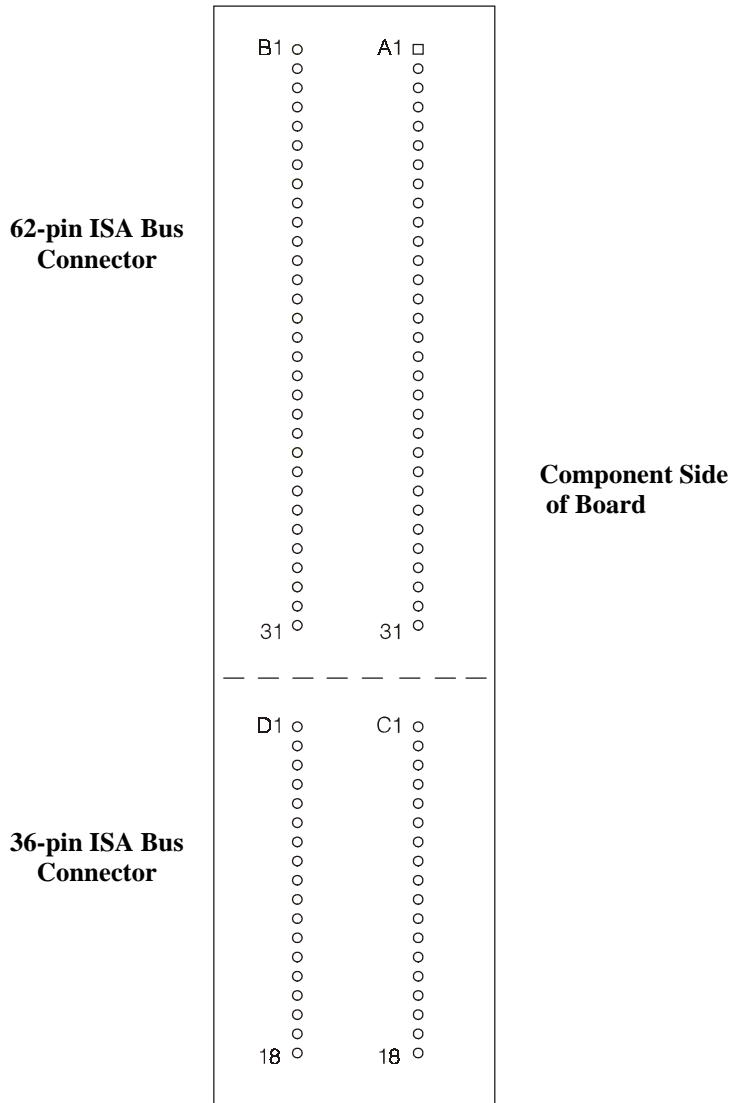

**ISA BUS PIN
ASSIGNMENTS**

The following tables summarize pin assignments for the Industry Standard Architecture (ISA) Bus connectors.

| I/O Pin | Signal Name | I/O | I/O Pin | Signal Name | I/O |
|---------|-------------|-----|---------|-------------|--------|
| A1 | IOCHK# | I | B1 | Gnd | Ground |
| A2 | D7 | I/O | B2 | RESDRV | O |
| A3 | D6 | I/O | B3 | +5V | Power |
| A4 | D5 | I/O | B4 | IRQ9 | I |
| A5 | D4 | I/O | B5 | -5V | Power |
| A6 | D3 | I/O | B6 | DRQ2 | I |
| A7 | D2 | I/O | B7 | -12V | Power |
| A8 | D1 | I/O | B8 | NOWS# | I |
| A9 | D0 | I/O | B9 | +12V | Power |
| A10 | CHRDY | I | B10 | Gnd SMWTC# | Ground |
| A11 | AEN | O | B11 | SMRDC# | O |
| A12 | SA19 | I/O | B12 | IOWC# | O |
| A13 | SA18 | I/O | B13 | IORC# | I/O |
| A14 | SA17 | I/O | B14 | DAK3# | I/O |
| A15 | SA16 | I/O | B15 | DRQ3 | O |
| A16 | SA15 | I/O | B16 | DAK1# | I |
| A17 | SA14 | I/O | B17 | DRQ1 | O |
| A18 | SA13 | I/O | B18 | REFRESH# | I |
| A19 | SA12 | I/O | B19 | BCLK | I/O |
| A20 | SA11 | I/O | B20 | IRQ7 | O |
| A21 | SA10 | I/O | B21 | IRQ6 | I |
| A22 | SA9 | I/O | B22 | IRQ5 | I |
| A23 | SA8 | I/O | B23 | IRQ4 | I |
| A24 | SA7 | I/O | B24 | IRQ3 | I |
| A25 | SA6 | I/O | B25 | DAK2# | I |
| A26 | SA5 | I/O | B26 | T-C | O |
| A27 | SA4 | I/O | B27 | BALE | O |
| A28 | SA3 | I/O | B28 | +5V | O |
| A29 | SA2 | I/O | B29 | OSC | Power |
| A30 | SA1 | I/O | B30 | Gnd | O |
| A31 | SA0 | I/O | B31 | | Ground |

| I/O Pin | Signal Name | I/O | I/O Pin | Signal Name | I/O |
|---------|-------------|-----|---------|-------------|--------|
| C1 | SBHE# | I/O | D1 | M16# | I |
| C2 | LA23 | I/O | D2 | IO16# | I |
| C3 | LA22 | I/O | D3 | IRQ10 | I |
| C4 | LA21 | I/O | D4 | IRQ11 | I |
| C5 | LA20 | I/O | D5 | IRQ12 | I |
| C6 | LA19 | I/O | D6 | IRQ15 | I |
| C7 | LA18 | I/O | D7 | IRQ14 | I |
| C8 | LA17 | I/O | D8 | DAK0# | O |
| C9 | MRDC# | I/O | D9 | DRQ0 | I |
| C10 | MWTC# | I/O | D10 | DAK5# | O |
| C11 | D8 | I/O | D11 | DRQ5 | I |
| C12 | D9 | I/O | D12 | DAK6# | O |
| C13 | D10 | I/O | D13 | DRQ6 | I |
| C14 | D11 | I/O | D14 | DAK7# | O |
| C15 | D12 | I/O | D15 | DRQ7 | I |
| C16 | D13 | I/O | D16 | +5V | Power |
| C17 | D14 | I/O | D17 | Master16# | I |
| C18 | D15 | I/O | D18 | Gnd | Ground |

ISA BUS SIGNAL DESCRIPTIONS

The following is a description of the ISA Bus signals. All signal lines are TTL-compatible.

AEN (O)

Address Enable (AEN) is used to degate the microprocessor and other devices from the I/O channel to allow DMA transfers to take place. When this line is active, the DMA controller has control of the address bus, the data-bus Read command lines (memory and I/O), and the Write command lines (memory and I/O).

BALE (O) (Buffered)

Address Latch Enable (BALE) is provided by the bus controller and is used on the system board to latch valid addresses and memory decodes from the microprocessor. It is available to the I/O channel as an indicator of a valid microprocessor or DMA address (when used with AEN). Microprocessor addresses SA[19:0] are latched with the falling edge of BALE. BALE is forced high during DMA cycles.

BCLK (O)

BCLK is the system clock. The clock has a 50% duty cycle. This signal should only be used for synchronization. It is not intended for uses requiring a fixed frequency.

CHRDY (I)

I/O Channel Ready (CHRDY) is pulled low (not ready) by a memory or I/O device to lengthen I/O or memory cycles. Any slow device using this line should drive it low immediately upon detecting its valid address and a Read or Write command. Machine cycles are extended by an integral number of clock cycles. This signal should be held low for no more than 2.5 microseconds.

D[15:0] (I/O)

Data signals D[15:0] provide bus bits 15 through 0 for the microprocessor, memory, and I/O devices. D15 is the most-significant bit and D0 is the least-significant bit. All 8-bit devices on the I/O channel should use D[7:0] for communications to the microprocessor. The 16-bit devices will use D[15:0]. To support 8-bit devices, the data on D[15:8] will be gated to D[7:0] during 8-bit transfers to these devices. 16-bit microprocessor transfers to 8-bit devices will be converted to two 8-bit transfers.

DAK[7:5]#, DAK[3:0]# (O)

DMA Acknowledge DAK[7:5]# and DAK[3:0]# are used to acknowledge DMA requests DRQ[7:5] and DRQ[3:0]. They are active low.

DRQ[7:5], DRQ[3:0] (I)

DMA Requests DRQ[7:5] and DRQ[3:0] are asynchronous channel requests used by peripheral devices and the I/O channel microprocessors to gain DMA service (or control of the system). They are prioritized, with DRQ0 having the highest priority and DRQ7 having the lowest. A request is generated by bringing a DRQ line to an active level. A DRQ line must be held high until the corresponding DMA Request Acknowledge (DAK) line goes active. DRQ[3:0] will perform 8-bit DMA transfers; DRQ[7:5] will perform 16-bit transfers.

IO16# (I)

I/O 16-bit Chip Select (IO16#) signals the system board that the present data transfer is a 16-bit, 1 wait-state, I/O cycle. It is derived from an address decode. IO16# is active low and should be driven with an open collector or tri-state driver capable of sinking 20 mAmps.

IOCHK# (I)

I/O Channel Check (IOCHK#) provides the system board with parity (error) information about memory or devices on the I/O channel. When this signal is active, it indicates an uncorrectable system error.

IORC# (I/O)

I/O Read (IORC#) instructs an I/O device to drive its data onto the data bus. It may be driven by the system microprocessor or DMA controller, or by a microprocessor or DMA controller resident on the I/O channel. This signal is active low.

IOWC# (I/O)

I/O Write (IOWC#) instructs an I/O device to read the data on the data bus. It may be driven by any microprocessor or DMA controller in the system. This signal is active low.

IRQ[15::14], IRQ[12::9], IRQ[7::3] (I)

Interrupt Requests IRQ[15::14], IRQ[12::9] and IRQ[7::3] are used to signal the microprocessor that an I/O device needs attention. The interrupt requests are prioritized, with IRQ[15::14] and IRQ[12::9] having the highest priority (IRQ9 is the highest) and IRQ[7::3] having the lowest priority (IRQ7 is the lowest). An interrupt request is generated when an IRQ line is raised from low to high. The line must be held high until the microprocessor acknowledges the interrupt request (Interrupt Service routine).

LA[23::17] (I/O)

These signals (unlatched) are used to address memory and I/O devices within the system. They give the system up to 16MB of addressability. These signals are valid when BALE is high. LA[23::17] are not latched during microprocessor cycles and therefore do not stay valid for the whole cycle. Their purpose is to generate memory decodes for 1 wait-state memory cycles. These decodes should be latched by I/O adapters on the falling edge of BALE. These signals also may be driven by other microprocessors or DMA controllers that reside on the I/O channel.

M16# (I)

M16# Chip Select signals the system board if the present data transfer is a 1<N>wait-state, 16-bit, memory cycle. It must be derived from the decode of LA[23::17]. M16# should be driven with an open collector or tri-state driver capable of sinking 20 mAmps.

Master16# (I)

Master16# is used with a DRQ line to gain control of the system. A processor or DMA controller on the I/O channel may issue a DRQ to a DMA channel in cascade mode and receive a DAK#. Upon receiving the DAK#, an I/O microprocessor may pull Master16# low, which will allow it to control the system address, data, and control lines (a condition known as tri-state). After Master16# is low, the I/O microprocessor must wait one system clock period before driving the address and data lines, and two clock periods before issuing a Read or Write command. If this signal is held low for more than 15<N>microseconds, system memory may be lost because of a lack of refresh.

NOWS# (I)

The No Wait State (NOWS#) signal tells the microprocessor that it can complete the present bus cycle without inserting any additional wait cycles. In order to run a memory cycle to a 16-bit device without wait cycles, NOWS# is derived from an address decode gated with a Read or Write command. In order to run a memory cycle to an 8-bit device with a minimum of two wait states, NOWS# should be driven active on system clock after the Read or Write command is active gated with the address decode for the device. Memory Read and Write commands to a 8-bit device are active on the falling edge of the system clock. NOWS# is active low and should be driven with an open collector or tri-state driver capable of sinking 20 mAmps.

OSC (O)

Oscillator (OSC) is a high-speed clock with a 70-nanosecond period (14.31818 MHz). This signal is not synchronous with the system clock. It has a 50% duty cycle.

REFRESH# (I/O)

The REFRESH# signal is used to indicate a refresh cycle and can be driven by a microprocessor on the I/O channel.

RESDRV (O)

Reset Drive (RESDRV) is used to reset or initialize system logic at power-up time or during a low line-voltage outage. This signal is active high.

SA[19::0] (I/O)

Address bits SA[19::0] are used to address memory and I/O devices within the system. These twenty address lines, in addition to LA[23::17], allow access of up to 16MB of memory. SA[19::0] are gated on the system bus when BALE is high and are latched on the falling edge of BALE. These signals are generated by the microprocessor or DMA Controller. They also may be driven by other microprocessors or DMA controllers that reside on the I/O channel.

SBHE# (I/O)

System Bus High Enable (SBHE#) indicates a transfer of data on the upper byte of the data bus, D[15::8]. 16-bit devices use SBHE# to condition data bus buffers tied to D[15::8].

SMRDC# (O), MRDC# (I/O)

These signals instruct the memory devices to drive data onto the data bus. SMRDC# is active only when the memory decode is within the low 1MB of memory space. MRDC# is active on all memory read cycles. MRDC# may be driven by any microprocessor or DMA controller in the system. SMRDC is derived from MRDC# and the decode of the low 1MB of memory. When a microprocessor on the I/O channel wishes to drive MRDC#, it must have the address lines valid on the bus for one system clock period before driving MRDC# active. Both signals are active low.

SMWTC# (O), MWTC# (I/O)

These signals instruct the memory devices to store the data present on the data bus. SMWTC# is active only when the memory decode is within the low 1MB of the memory space. MWTC# is active on all memory write cycles. MWTC# may be driven by any microprocessor or DMA controller in the system. SMWTC# is derived from MWTC# and the decode of the low 1MB of memory. When a microprocessor on the I/O channel wishes to drive MWTC#, it must have the address lines valid on the bus for one system clock period before driving MWTC# active. Both signals are active low.

T-C (O)

Terminal Count (T-C) provides a pulse when the terminal count for any DMA channel is reached.

I/O ADDRESS MAP*

| Hex Range | Device |
|-----------|---|
| 000-01F | DMA Controller 1 |
| 020-03F | Interrupt Controller 1, Master |
| 040-05F | Timer |
| 060-06F | 8042 (Keyboard) |
| 070-07F | Realtime Clock, NMI (non-maskable interrupt) Mask |
| 080-09F | DMA Page Register |
| 0A0-0BF | Interrupt Controller 2 |
| 0C0-0DF | DMA Controller 2 |
| 0F0 | Clear Math Coprocessor Busy |
| 0F1 | Reset Math Coprocessor |
| 0F8-0FF | Math Coprocessor |
| 1F0-1F8 | Fixed Disk |
| 200-207 | Game I/O |
| 278-27F | Parallel Printer Port 2 |
| 2F8-2FF | Serial Port 2 |
| 300-31F | Prototype Card |
| 360-36F | Reserved |
| 378-37F | Parallel Printer Port 1 |
| 380-38F | SDLC, Bisynchronous 2 |
| 3A0-3AF | Bisynchronous 1 |
| 3B0-3BF | Monochrome Display and Printer Adapter |
| 3C0-3CF | Reserved |
| 3D0-3DF | Color/Graphics Monitor Adapter |
| 3F0-3F7 | Diskette Controller |
| 3F8-3FF | Serial Port 1 |

INTERRUPT ASSIGNMENTS*

| Interrupt | Description |
|-----------|---|
| IRQ0 | Timer Output 0 |
| IRQ1 | Keyboard (Output Buffer Full) |
| IRQ2 | Interrupt 8 through 15 |
| IRQ3 | Serial Port 2 |
| IRQ4 | Serial Port 1 |
| IRQ5 | Parallel Port 2 |
| IRQ6 | Diskette Controller |
| IRQ7 | Parallel Port 1 |
| IRQ8 | Realtime Clock Interrupt |
| IRQ9 | Software Redirected to INT 0AH (IRQ2) |
| IRQ10 | Unassigned |
| IRQ11 | Unassigned |
| IRQ12 | PS/2 Mouse |
| IRQ13 | Coprocessor |
| IRQ14 | Fixed Disk Controller |
| IRQ15 | Unassigned (may be assigned by the system to the secondary IDE) |

* These are typical parameters, which may not reflect your current system.

**PCI LOCAL BUS
OVERVIEW**

The PCI (Peripheral Component Interconnect) Local Bus is a high performance, 32-bit or 64-bit bus with multiplexed address and data lines. It is intended for use as an interconnect mechanism between highly integrated peripheral controller components, peripheral add-in boards and processor/memory systems.

The "local bus" moves peripheral functions with high bandwidth requirements closer to the system's processor bus and can produce substantial performance gains with graphical user interfaces (GUI's) and other high bandwidth functions (i.e., full motion video, SCSI, LAN's, etc.).

The PCI Local Bus accommodates future system requirements and is applicable across multiple platforms and architectures.

The PCI component and add-in card interface is processor independent, enabling an efficient transition to future processor generations, by bridges or by direct integration, and use with multiple processor architectures. Processor independence allows the PCI Local Bus to be optimized for I/O functions, enables concurrent operation of the local bus with the processor/memory subsystem, and accommodates multiple high performance peripherals in addition to graphics. Movement to enhanced video and multimedia displays and other high bandwidth I/O will continue to increase local bus bandwidth requirements. A transparent 64-bit extension of the 32-bit data and address buses is defined, doubling the bus bandwidth and offering forward and backward compatibility of 32-bit (132MB/s peak) and 64-bit (264MB/s peak) PCI Local Bus peripherals.

**PCI LOCAL BUS
SIGNAL DEFINITION**

The PCI interface requires a minimum of 47 pins for a target-only device and 49 pins for a master to handle data and addressing, interface control, arbitration and system functions. The diagram below shows the pins in functional groups, with required pins on the left side and optional pins on the right side.

Required Pins:

Address & Data:
AD[31::00]

C/BE[3::0]#

PAR

Interface Control:

FRAME#

TRDY#

IRDY#

STOP#

DEVSEL#

IDSEL

Error Reporting:

PERR#

SERR#

Arbitration

(masters only):

REQ#

GNT#

System:

CLK

RST#

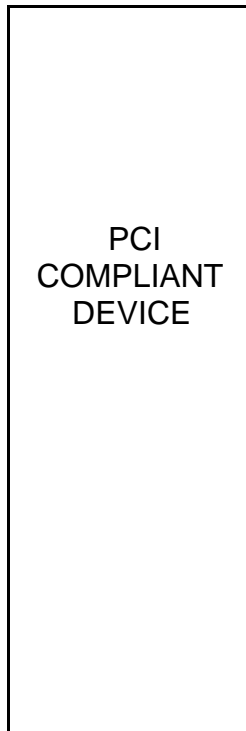

Optional Pins:

64-bit Extension
AD[63::32]

C/BE[7::4]#

PAR64

REQ64#

ACK64#

Interface Control:

LOCK#

INTA#

INTB#

INTC#

INTD#

Cache Support:

SBO#

SDONE

JTAG (IEEE 1149.1):

TDI

TDO

TCK

TMS

TRST#

PCI Pin List

**PCI LOCAL BUS
PIN NUMBERING**

**Component Side
of Board**

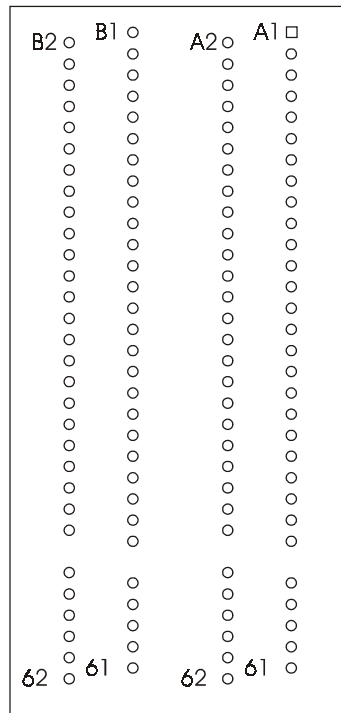

5-volt/32-bit PCI Connector

**PCI LOCAL BUS
PIN ASSIGNMENTS**

The PCI Local Bus pin assignments shown below are for the PCI option slots on the backplane.

The PCI Local Bus specifies both 5-volt and 3.3-volt signaling environments. The following bus pin assignments are for the 5-volt connector. The 3.3-volt connector bus pin assignments are the same with the following exceptions:

- * The pins noted as +V (I/O) are +5 volts or +3.3 volts, depending on which connector is being used.
- † Pins B12, B13, A12 and A13 are Gnd (ground) on the 5-volt connector, but are Connector Keys on the 3.3-volt connector.
- †† Pin B49 is Gnd (ground) on the 5-volt connector, but is M66EN on the 3.3-volt connector.
- ††† Pins B50, B51, A50 and A51 are Connectors Keys on the 5-volt connector, but are Gnd (ground) on the 3.3-volt connector.

| I/O Pin | Signal Name | I/O Pin | Signal Name |
|---------|-------------|---------|-------------|
| B1 | -12V | A1 | TRST# |
| B2 | TCK | A2 | +12V |
| B3 | Gnd | A3 | TMS |
| B4 | TDO | A4 | TDI |
| B5 | +5V | A5 | +5V |
| B6 | +5V | A6 | INTA# |
| B7 | INTB# | A7 | INTC# |
| B8 | INTD# | A8 | +5V |
| B9 | PRSNT1# | A9 | Reserved |
| B10 | Reserved | A10 | +V (I/O) * |
| B11 | PRSNT2# | A11 | Reserved |
| B12 | Gnd † | A12 | Gnd † |
| B13 | Gnd † | A13 | Gnd † |
| B14 | Reserved | A14 | Reserved |
| B15 | Gnd | A15 | RST# |
| B16 | CLK | A16 | +V (I/O) * |
| B17 | Gnd | A17 | GNT# |
| B18 | REQ# | A18 | Gnd |
| B19 | +V (I/O) * | A19 | Reserved |
| B20 | AD31 | A20 | AD30 |
| B21 | AD29 | A21 | +3.3V |
| B22 | Gnd | A22 | AD28 |
| B23 | AD27 | A23 | AD26 |
| B24 | AD25 | A24 | Gnd |
| B25 | +3.3V | A25 | AD24 |
| B26 | C/BE3# | A26 | IDSEL |
| B27 | AD23 | A27 | +3.3V |
| B28 | Gnd | A28 | AD22 |
| B29 | AD21 | A29 | AD20 |
| B30 | AD19 | A30 | Gnd |
| B31 | +3.3V | A31 | AD18 |
| B32 | AD17 | A32 | AD16 |
| B33 | C/BE2# | A33 | +3.3V |
| B34 | Gnd | A34 | FRAME# |
| B35 | IRDY# | A35 | Gnd |

32-bit connector

**PCI LOCAL BUS
PIN ASSIGNMENTS
(CONTINUED)**

| I/O Pin | Signal Name | I/O Pin | Signal Name | |
|---------|-------------------|---------|-------------------|----------------------|
| B36 | +3.3V | A36 | TRDY# | |
| B37 | DEVSEL# | A37 | Gnd | |
| B38 | Gnd | A38 | STOP# | |
| B39 | LOCK# | A39 | +3.3V | |
| B40 | PERR# | A40 | SDONE | |
| B41 | +3.3V | A41 | SBO# | |
| B42 | SERR# | A42 | Gnd | |
| B43 | +3.3V | A43 | PAR | |
| B44 | C/BE1# | A44 | AD15 | |
| B45 | AD14 | A45 | +3.3V | |
| B46 | Gnd | A46 | AD13 | |
| B47 | AD12 | A47 | AD11 | |
| B48 | AD10 | A48 | Gnd | |
| B49 | Gnd †† | A49 | AD9 | |
| B50 | Connector Key ††† | A50 | Connector Key ††† | 5-volt key |
| B51 | Connector Key ††† | A51 | Connector Key ††† | 5-volt key |
| B52 | AD8 | A52 | C/BE0# | |
| B53 | AD7 | A53 | +3.3V | |
| B54 | +3.3V | A54 | AD6 | |
| B55 | AD5 | A55 | AD4 | |
| B56 | AD3 | A56 | Gnd | |
| B57 | Gnd | A57 | AD2 | |
| B58 | AD1 | A58 | AD0 | |
| B59 | +V (I/O) * | A59 | +V (I/O) * | |
| B60 | ACK64# | A60 | REQ64# | |
| B61 | +5V | A61 | +5V | |
| B62 | +5V | A62 | +5V | 32-bit connector end |

**PCI LOCAL BUS
PIN ASSIGNMENTS
(CONTINUED)**

The following pin assignments apply only to backplanes with 64-bit PCI option slots.

| I/O Pin | Signal Name | I/O Pin | Signal Name |
|---------|---------------|---------|---------------|
| | Connector Key | | Connector Key |
| | Connector Key | | Connector Key |
| B63 | Reserved | A63 | Gnd |
| B64 | Gnd | A64 | C/BE7# |
| B65 | C/BE6# | A65 | C/BE5# |
| B66 | C/BE4# | A66 | +V (I/O) * |
| B67 | Gnd | A67 | PAR64 |
| B68 | AD63 | A68 | AD62 |
| B69 | AD61 | A69 | Gnd |
| B70 | +V (I/O) * | A70 | AD60 |
| B71 | AD59 | A71 | AD58 |
| B72 | AD57 | A72 | Gnd |
| B73 | Gnd | A73 | AD56 |
| B74 | AD55 | A74 | AD54 |
| B75 | AD53 | A75 | +V (I/O) * |
| B76 | Gnd | A76 | AD52 |
| B77 | AD51 | A77 | AD50 |
| B78 | AD49 | A78 | Gnd |
| B79 | +V (I/O) * | A79 | AD48 |
| B80 | AD47 | A80 | AD46 |
| B81 | AD45 | A81 | Gnd |
| B82 | Gnd | A82 | AD44 |
| B83 | AD43 | A83 | AD42 |
| B84 | AD41 | A84 | +V (I/O) * |
| B85 | Gnd | A85 | AD40 |
| B86 | AD39 | A86 | AD38 |
| B87 | AD37 | A87 | Gnd |
| B88 | +V (I/O) * | A88 | AD36 |
| B89 | AD35 | A89 | AD34 |
| B90 | AD33 | A90 | Gnd |
| B91 | Gnd | A91 | AD32 |
| B92 | Reserved | A92 | Reserved |
| B93 | Reserved | A93 | Gnd |
| B94 | Gnd | A94 | Reserved |

64-bit spacer

64-bit spacer

64-bit connector start

64-bit connector end

**PCI LOCAL BUS
SIGNAL
DESCRIPTIONS**

The PCI Local Bus signals are described below and may be categorized into the following functional groups:

- System Pins
- Address and Data Pins
- Interface Control Pins
- Arbitration Pins (Bus Masters Only)
- Error Reporting Pins
- Interrupt Pins (Optional)
- Cache Support Pins (Optional)
- 64-Bit Bus Extension Pins (Optional)
- JTAG/Boundary Scan Pins (Optional)

A # symbol at the end of a signal name indicates that the active state occurs when the signal is at a low voltage. When the # symbol is absent, the signal is active at a high voltage.

The following are descriptions of the PCI Local Bus signals.

ACK64# (optional)

Acknowledge 64-bit Transfer, when actively driven by the device that has positively decoded its address as the target of the current access, indicates the target is willing to transfer data using 64bits. ACK64# has the same timing as DEVSEL#.

AD[31::00]

Address and Data are multiplexed on the same PCI pins. A bus transaction consists of an address phase followed by one or more data phases. During the address phase, AD[31::00] contain a physical address (32 bits). During data phases, AD[07::00] contain the least significant byte (lsb) and AD[31::24] contain the most significant byte (msb).

AD[63::32] (optional)

Address and Data are multiplexed on the same pins and provide 32additional bits. During an address phase (when using the DAC command and when REQ64# is asserted), the upper 32bits of a 64-bit address are transferred; otherwise, these bits are reserved but are stable and indeterminate. During a data phase, an additional 32bits of data are transferred when REQ64# and ACK64# are both asserted.

C/BE[3::0]#

Bus Command and Byte Enables are multiplexed on the same PCI pins. During the address phase of a transaction, these pins define the bus command; during the data phase they are used as byte enables. The byte enables are valid for the entire data phase and determine which byte lanes carry meaningful data. C/BE0# applies to byte0 (lsb) and C/BE3# applies to byte 3 (msb).

C/BE[7::4]# (optional)

Bus Command and Byte Enables are multiplexed on the same pins. During an address phase (when using the DAC command and when REQ64# is asserted), the actual bus command is transferred on C/BE[7::4]#; otherwise, these bits are reserved and indeterminate. During a data phase, C/BE[7::4]# are byte enables indicating which byte lanes carry meaningful data when REQ64# and ACK64# are both asserted. C/BE4# applies to byte4 and C/BE7# applies to byte7.

CLK

Clock provides timing for all transactions on PCI and is an input to every PCI device.

DEVSEL#

Device Select, when actively driven, indicates that the driving device has decoded its address as the target of the current access. As an input, DEVSEL# indicates whether any device on the bus has been selected.

FRAME#

Cycle Frame is an interface control pin which is driven by the current master to indicate the beginning and duration of an access. When FRAME# is asserted, data transfers continue; when it is deasserted, the transaction is in the final data phase.

GNT#

Grant indicates to the agent that access to the bus has been granted. This is a point to point signal. Every master has its own GNT#.

IDSEL

Initialization Device Select is used as a chip select during configuration read and write transactions.

INTA#, INTB#, INTC#, INTD# (optional)

Interrupts on PCI are optional and defined as "level sensitive," asserted low (negative true), using open drain output drivers. PCI defines one interrupt for a single function and up to four interrupt lines for a multi-function device or connector.

Interrupt A is used to request an interrupt. For a single function device, only INTA# may be used, while the other three interrupt lines have no meaning.

Interrupt B, Interrupt C and Interrupt D are used to request additional interrupts and only have meaning on a multi-function device.

IRDY#

Initiator Ready indicates the initiating agent's (bus master's) ability to complete the current data phase of the transaction. IRDY# is used in conjunction with TRDY#. During a write, IRDY# indicates that valid data is present on AD[31::0]. During a read, it indicates that the master is prepared to accept data.

LOCK#

Lock indicates an operation that may require multiple transactions to complete. When LOCK# is asserted, non-exclusive transactions may proceed to an address that is not currently locked.

PAR

Parity is even parity across AD[31::00] and C/BE[3::0]#. Parity generation is required by all PCI agents. The master drives PAR for address and write data phases; the target drives PAR for read data phases.

PAR64 (optional)

Parity Upper DWORD is the even parity bit that protects AD[63::32] and C/BE[7::4]#. The master drives PAR64 for address and write data phases; the target drives PAR64 for read data phases.

PERR#

Parity Error is for the reporting of data parity errors during all PCI transactions except a Special Cycle. There are no special conditions when a data parity error may be lost or when reporting of an error may be delayed.

PRSNT1# and PRSNT2#

PRSNT1# and PRSNT2# are related to the connector only, not to other PCI components. They are used for two purposes: indicating that a board is physically present in the slot and providing information about the total power requirements of the board.

REQ#

Request indicates to the arbiter that this agent desires use of the bus. This is a point to point signal. Every master has its own REQ#.

REQ64# (optional)

Request 64-bit Transfer, when actively driven by the current bus master, indicates it desires to transfer data using 64 bits. REQ64# has the same timing as FRAME#. REQ64# has meaning at the end of reset.

RST#

Reset is used to bring PCI-specific registers, sequencers and signals to a consistent state.

SBO# (optional)

Snoop Backoff is an optional cache support pin which indicates a hit to a modified line when asserted. When SBO# is deasserted and SDONE is asserted, it indicates a "clean" snoop result.

SDONE (optional)

Snoop Done is an optional cache support pin which indicates the status of the snoop for the current access. When deasserted, it indicates the result of the snoop is still pending. When asserted, it indicates the snoop is complete.

SERR#

System Error is for reporting address parity errors, data parity errors on the Special Cycle command, or any other system error where the result will be catastrophic. If an agent does not want a non-maskable interrupt (NMI) to be generated, a different reporting mechanism is required.

STOP#

Stop indicates that the current target is requesting the master to stop the current transaction.

TCK (optional)

Test Clock is used to clock state information and test data into and out of the device during operation of the TAP (Test Access Port).

TDI (optional)

Test Data Input is used to serially shift test data and test instructions into the device during TAP (Test Access Port) operation.

TDO (optional)

Test Data Output is used to serially shift test data and test instructions out of the device during TAP (Test Access Port) operation.

TMS (optional)

Test Mode Select is used to control the state of the TAP (Test Access Port) controller in the device.

TRDY#

Target Ready indicates the target agent's (selected device's) ability to complete the current data phase of the transaction. TRDY# is used in conjunction with IRDY#. During a read, TRDY# indicates that valid data is present on AD[31::00]. During a write, it indicates that the target is prepared to accept data.

TRST# (optional)

Test Reset provides an asynchronous initialization of the TAP controller. This signal is optional in the IEEE Standard Test Access Port and Boundary Scan Architecture.

**PICMG EDGE
CONNECTOR PIN
ASSIGNMENTS**

The pin assignments shown below are for the PICMG portion of the edge connector on the processor board. These pin assignments match those of the PICMG connector of the processor slot on the backplane.

| I/O Pin | Signal Name | I/O Pin | Signal Name |
|---------|-------------|---------|-------------|
| B1 | -12V | A1 | NC |
| B2 | NC | A2 | +12V |
| B3 | Gnd | A3 | NC |
| B4 | NC | A4 | NC |
| B5 | +5V | A5 | +5V |
| B6 | +5V | A6 | INTA# |
| B7 | INTB# | A7 | INTC# |
| B8 | INTD# | A8 | +5V |
| B9 | REQ3# | A9 | CLKS2 |
| B10 | REQ1# | A10 | +5V |
| B11 | GNT3# | A11 | CLKS3 |
| B12 | Gnd | A12 | Gnd |
| B13 | Gnd | A13 | Gnd |
| B14 | CLKS0 | A14 | GNT1# |
| B15 | Gnd | A15 | RST# |
| B16 | CLKS1 | A16 | +5V |
| B17 | Gnd | A17 | GNT0# |
| B18 | REQ0# | A18 | Gnd |
| B19 | +5V | A19 | REQ2# |
| B20 | AD31 | A20 | AD30 |
| B21 | AD29 | A21 | NC |
| B22 | Gnd | A22 | AD28 |
| B23 | AD27 | A23 | AD26 |
| B24 | AD25 | A24 | Gnd |
| B25 | BKPL3.3V | A25 | AD24 |
| B26 | C/BE3# | A26 | GNT2# |
| B27 | AD23 | A27 | NC |
| B28 | Gnd | A28 | AD22 |
| B29 | AD21 | A29 | AD20 |
| B30 | AD19 | A30 | Gnd |
| B31 | NC | A31 | AD18 |
| B32 | AD17 | A32 | AD16 |
| B33 | C/BE2# | A33 | NC |
| B34 | Gnd | A34 | FRAME# |
| B35 | IRDY# | A35 | Gnd |
| B36 | NC | A36 | TRDY# |
| B37 | DEVSEL# | A37 | Gnd |
| B38 | Gnd | A38 | STOP# |
| B39 | LOCK# | A39 | NC |
| B40 | PERR# | A40 | SDONE |
| B41 | NC | A41 | SBO# |
| B42 | SERR# | A42 | Gnd |
| B43 | NC | A43 | PAR |
| B44 | C/BE1# | A44 | AD15 |
| B45 | AD14 | A45 | NC |
| B46 | Gnd | A46 | AD13 |
| B47 | AD12 | A47 | AD11 |
| B48 | AD10 | A48 | Gnd |
| B49 | M66EN | A49 | AD9 |

32-bit connector start

**PICMG EDGE
CONNECTOR PIN
ASSIGNMENTS
(CONTINUED)**

| I/O Pin | Signal Name | I/O Pin | Signal Name |
|---------|---------------|---------|---------------|
| B50 | Connector Key | A50 | Connector Key |
| B51 | Connector Key | A51 | Connector Key |
| B52 | AD8 | A52 | C/BE0# |
| B53 | AD7 | A53 | NC |
| B54 | NC | A54 | AD6 |
| B55 | AD5 | A55 | AD4 |
| B56 | AD3 | A56 | Gnd |
| B57 | Gnd | A57 | AD2 |
| B58 | AD1 | A58 | AD0 |
| B59 | +5V | A59 | +5V |
| B60 | ACK64# | A60 | REQ64# |
| B61 | +5V | A61 | +5V |
| B62 | +5V | A62 | +5V |

32-bit connector end

**PICMG EDGE
CONNECTOR PIN
ASSIGNMENTS
(CONTINUED)**

The following pin assignments apply only to SBCs with 64-bit PICMG connectors.

| I/O Pin | Signal Name | I/O Pin | Signal Name |
|---------|---------------|---------|---------------|
| | Connector Key | | Connector Key |
| | Connector Key | | Connector Key |
| B63 | NC | A63 | Gnd |
| B64 | Gnd | A64 | C/BE7# |
| B65 | C/BE6# | A65 | C/BE5# |
| B66 | C/BE4# | A66 | +5V |
| B67 | Gnd | A67 | PAR64 |
| B68 | AD63 | A68 | AD62 |
| B69 | AD61 | A69 | Gnd |
| B70 | +5V | A70 | AD60 |
| B71 | AD59 | A71 | AD58 |
| B72 | AD57 | A72 | Gnd |
| B73 | Gnd | A73 | AD56 |
| B74 | AD55 | A74 | AD54 |
| B75 | AD53 | A75 | +5V |
| B76 | Gnd | A76 | AD52 |
| B77 | AD51 | A77 | AD50 |
| B78 | AD49 | A78 | Gnd |
| B79 | +5V | A79 | AD48 |
| B80 | AD47 | A80 | AD46 |
| B81 | AD45 | A81 | Gnd |
| B82 | Gnd | A82 | AD44 |
| B83 | AD43 | A83 | AD42 |
| B84 | AD41 | A84 | +5V |
| B85 | Gnd | A85 | AD40 |
| B86 | AD39 | A86 | AD38 |
| B87 | AD37 | A87 | Gnd |
| B88 | +5V | A88 | AD36 |
| B89 | AD35 | A89 | AD34 |
| B90 | AD33 | A90 | Gnd |
| B91 | Gnd | A91 | AD32 |
| B92 | NC | A92 | NC |
| B93 | NC | A93 | Gnd |
| B94 | Gnd | A94 | NC |

64-bit spacer

64-bit spacer

64-bit connector start

64-bit connector end

Chapter 3 System BIOS

BIOS OPERATION Sections 3 through 7 of this manual describe the operation of the American Megatrends AMIBIOS and the BIOS Setup Utility. Refer to *Running AMIBIOS Setup* later in this chapter for standard Setup screens, options and defaults. The available Setup screens, options and defaults may vary if you have a custom BIOS.

When the system is powered on, AMIBIOS performs the Power-On Self Test (POST) routines. These routines are divided into two phases:

- 1) **System Test and Initialization.** Test and initialize system boards for normal operations.
- 2) **System Configuration Verification.** Compare defined configuration with hardware actually installed.

If an error is encountered during the diagnostic tests, the error is reported in one of two different ways. If the error occurs before the display device is initialized, a series of beeps is transmitted. If the error occurs after the display device is initialized, the error message is displayed on the screen. See *BIOS Errors* later in this section for more information on error handling.

The following are some of the Power-On Self Tests (POST's) which are performed when the system is powered on:

- CMOS Checksum Calculation
- Keyboard Controller Test
- CMOS Shutdown Register Test
- 8254 Timer Test
- Memory Refresh Test
- Display Memory Read/Write Test
- Display Type Verification
- Entering Protected Mode
- Memory Size Calculation
- Conventional and Extended Memory Test
- DMA Controller Tests
- Keyboard Test
- System Configuration Verification and Setup

AMIBIOS checks system memory and reports it on both the initial AMIBIOS screen and the AMIBIOS System Configuration screen which appears after POST is completed. AMIBIOS attempts to initialize the peripheral devices and if it detects a fault, the screen displays the error condition(s) which has/have been detected. If no errors are detected, AMIBIOS attempts to load the system from a bootable device, such as a floppy disk or hard disk. Boot order may be specified by the **Boot Device Priority** option on the Boot Setup Menu as described in the *Boot Setup* chapter later in this manual.

Normally, the only POST routine visible on the screen is the memory test. The following screen displays when the system is powered on:

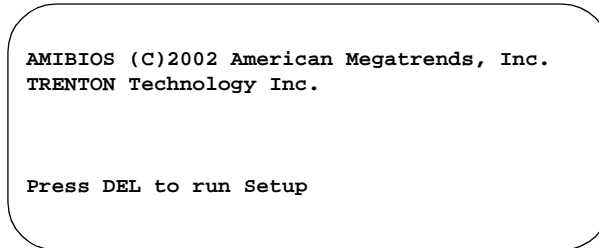

Initial Power-On Screen

You have two options:

- Press to access the BIOS Setup Utility.

This option allows you to change various system parameters such as date and time, disk drives, etc. The *Running AMIBIOS Setup* section of this manual describes the options available.

You may be requested to enter a password before gaining access to the BIOS Setup Utility. (See *Password Entry* later in this section.)

If you enter the correct password or no password is required, the BIOS Setup Utility Main Menu displays. (See *Running AMIBIOS Setup* later in this section.)

- Allow the bootup process to continue without invoking the BIOS Setup Utility.

In this case, after AMIBIOS loads the system, you may be requested to enter a password. (See *Password Entry* later in this section.)

Once the POST routines complete successfully, a screen displays showing the current configuration of your system, including processor type, base and extended memory amounts, floppy and hard drive types, display type and peripheral ports.

Password Entry

The system may be configured so that the user is required to enter a password each time the system boots or whenever an attempt is made to enter the BIOS Setup Utility. The password function may also be disabled so that the password prompt does not appear under any circumstances.

The **Password Check** option in the Security Menu allows you to specify when the password prompt displays: **Always** or only when **Setup** is attempted. This option is available only if the supervisor and/or user password(s) have been established. The supervisor and user passwords may be changed using the **Change Supervisor Password** and **Change User Password** options on the Security Menu. If the passwords are null, the password prompt does not display at any time. See the *Security Setup* section of this chapter for details on setting up passwords.

When password checking is enabled, the following password prompt displays:

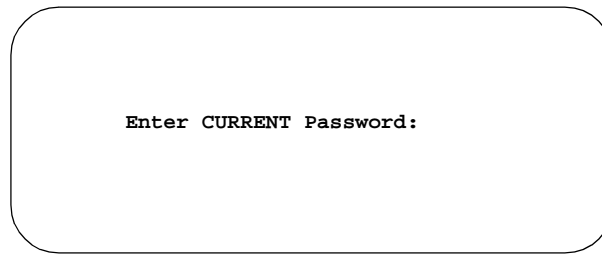

Type the password and press <Enter>.

NOTE: The null password is the system default and is in effect if a password has not been assigned or if the CMOS has been corrupted. In this case, the password prompt does not display. To set up passwords, you may use the **Change Supervisor Password** and **Change User Password** options on the Security Menu of the BIOS Setup Utility. (See the *Security Setup* section later in this chapter.)

If an incorrect password is entered, the following screen displays:

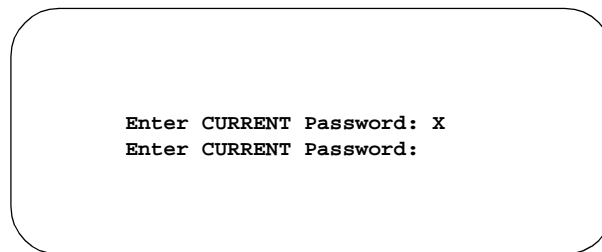

You may try again to enter the correct password. If you enter the password incorrectly three times, the system responds in one of two different ways, depending on the value specified in the **Password Check** option on the *Security Menu*:

- 1) If the **Password Check** option is set to **Setup**, the system does not let you enter Setup, but does continue the booting process. You must reboot the system manually to retry entering the password.
- 2) If the **Password Check** option is set to **Always**, the system locks and you must reboot. After rebooting, you will be requested to enter the password.

Once the password has been entered correctly, you are allowed to continue.

BIOS Errors

If an error is encountered during the diagnostic checks performed when the system is powered on, the error is reported in one of two different ways:

- 1) If the error occurs before the display device is initialized, a series of beeps is transmitted.
- 2) If the error occurs after the display device is initialized, the screen displays the error message. In the case of a non-fatal error, a prompt to press the <F1> key may also appear on the screen.

Explanations of the beep codes and BIOS error messages may be found in *Appendix A - BIOS Messages*.

As the POST routines are performed, test codes are presented on Port 80H. These codes may be helpful as a diagnostic tool and are listed in *Appendix A - BIOS Messages*.

If certain non-fatal error conditions occur, you are requested to run the BIOS Setup Utility. The error messages are followed by this screen:

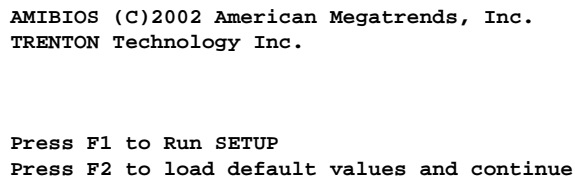
A screenshot of a BIOS error screen, enclosed in a rounded rectangular border. The text is displayed in a monospaced font. The first two lines are: "AMIBIOS (C)2002 American Megatrends, Inc." and "TRENTON Technology Inc.". There is a blank line. The next two lines are: "Press F1 to Run SETUP" and "Press F2 to load default values and continue".

```
AMIBIOS (C)2002 American Megatrends, Inc.  
TRENTON Technology Inc.  
  
Press F1 to Run SETUP  
Press F2 to load default values and continue
```

Press <F1>. You may be requested to enter a password before gaining access to the BIOS Setup Utility. (See *Password Entry* earlier in this section.)

If you enter the correct password or no password is required, the BIOS Setup Utility Main Menu displays.

**RUNNING
AMIBIOS SETUP**

AMIBIOS Setup keeps a record of system parameters, such as date and time, disk drives, display type and other user-defined parameters. The Setup parameters reside in the Read Only Memory Basic Input/Output System (ROM BIOS) so that they are available each time the system is turned on. The BIOS Setup Utility stores the information in the complementary metal oxide semiconductor (CMOS) memory. When the system is turned off, a backup battery retains system parameters in the CMOS memory.

Each time the system is powered on, it is configured with these values, unless the CMOS has been corrupted or is faulty. The BIOS Setup Utility is resident in the ROM BIOS so that it is available each time the computer is turned on. If, for some reason, the CMOS becomes corrupted, the system is configured with the default values stored in this ROM file.

As soon as the system is turned on, the power-on diagnostic routines check memory, attempt to prepare peripheral devices for action, and offer you the option of pressing **** to run the BIOS Setup Utility.

If certain non-fatal errors occur during the Power-On Self Test (POST) routines which are run when the system is turned on, you may be prompted to run the BIOS Setup Utility by pressing **<F1>**.

**BIOS SETUP
UTILITY MAIN
MENU**

When you press <F1> in response to an error message received during the POST routines or when you press the key to enter the BIOS Setup Utility, the following screen displays:

| BIOS SETUP UTILITY | | | | | | |
|---|----------|--------|---------|---|----------|------|
| Main | Advanced | PCIPnP | Chipset | Boot | Security | Exit |
| System Overview | | | | Use [ENTER], {TAB} or [SHIFT-TAB] to select a field. | | |
| AMIBIOS Version: 08.00.xx Build Date : 06/20/02 ID : 0ABAF013 | | | | Use [+] or [-] to configure System Time. | | |
| Processor Type : Intel(R) Pentium(R) 4 Speed : 2400MHz Count : 1 | | | | ←→ Select Screen ↑↓ Select Item +- Change Field Tab Select Field F1 General Help F10 Save and Exit ESC Exit | | |
| System Memory Size : 120MB | | | | | | |
| System Time [00:00:00] System Date [Mon 01/01/2001] | | | | | | |
| vxx.xx (C)Copyright 1985-2002, American Megatrends, Inc. | | | | | | |

BIOS Setup Utility Main Menu

When you display the BIOS Setup Utility Main Menu, the format is similar to the sample shown above. The data displayed on the top portion of the screen details parameters detected by AMIBIOS for your processor board and may not be modified. The system time and date displayed on the bottom portion of the screen may be modified.

**BIOS SETUP
UTILITY MAIN
MENU OPTIONS**

The descriptions for the system options listed below show the values as they appear if you have not changed them yet. Once values have been defined, they display each time the BIOS Setup Utility is run.

System Time/System Date

These options allow you to set the correct system time and date. If you do not set these parameters the first time you enter the BIOS Setup Utility, you will receive a "Run SETUP" error message when you boot the system until you set the correct parameters.

The Setup screen displays the system options:

| | |
|--------------------|-------------------------|
| System Time | [00:00:00] |
| System Date | [Mon 01/01/2001] |

There are three fields for entering the time or date. Use the <Tab> key or the <Enter> key to move from one field to another and type in the correct value for the field.

If you enter an invalid value in any field, the screen will revert to the previous value when you move to the next field. When you change the value for the month, day or year field, the day of the week changes automatically when you move to the next field.

BIOS SETUP UTILITY OPTIONS

The BIOS Setup Utility allows you to change system parameters to tailor your system to your requirements. Various options which may be changed are listed below. Further explanations of these options and available values may be found in later chapters of this manual, as noted below.

NOTE: Do *not* change the values for any option unless you understand the impact on system operation. Depending on your system configuration, selection of other values may cause unreliable system operation.

Use the **Right Arrow** key to display the desired menu. The following menus are available:

- Select **Advanced** to make changes to Advanced Setup parameters as described in the *Advanced Setup* chapter of this manual. The following options may be modified:
 - CPU Configuration
 - Ratio CMOS Setting
 - IDE Configuration
 - OnBoard PCI IDE Controller
 - Primary IDE Master/Primary IDE Slave
Secondary IDE Master/Secondary IDE Slave
 - Type
 - LBA/Large Mode
 - Block (Multi-Sector Transfer)
 - PIO Mode
 - DMA Mode
 - S.M.A.R.T.
 - 32Bit Data Transfer
 - ARMD Emulation Type
 - Hard Disk Write Protect
 - IDE Detect Time Out (Sec)
 - ATA(PI) 80Pin Cable Detection

- Floppy Configuration
 - Floppy A/Floppy B
- SuperIO Configuration
 - OnBoard Floppy Controller
 - Serial Port1 Address/Serial Port2 Address
 - Serial Port2 IRQ
 - Serial Port2 Mode
 - Parallel Port Address
 - Parallel Port Mode
 - Parallel Port IRQ
- DMI Event Logging
 - View Event Log
 - Mark All Events as Read
 - Clear Event Log
 - Event Log Statistics
- Remote Access Configuration
 - Remote Access
 - Serial Port Number
 - Serial Port Mode
 - Post-Boot Support
- USB Configuration
 - USB Function
 - Legacy USB Support
 - USB ZIP Emulation Type
 - USB Beep Message
- Select **PCIPnP** to make changes to PCI Plug and Play Setup parameters as described in the *PCI Plug and Play Setup* chapter of this manual. The following options may be modified:
 - Plug & Play O/S
 - Reset Config Data
 - PCI Latency Timer
 - Allocate IRQ to PCI VGA
 - Palette Snooping
 - PCI IDE BusMaster

- OffBoard PCI/ISA IDE Card
 - OffBoard PCI IDE Primary IRQ
 - OffBoard PCI IDE Secondary
- IRQs 3, 4, 5, 7, 9, 10, 11, 12, 14 and 15
- DMA Channels 0, 1, 3, 5, 6 and 7
- Reserved Memory Size
- Reserved Memory Address
- Select **Chipset** to make changes to Chipset Setup parameters as described in the *Chipset Setup* chapter of this manual. The following options may be modified:
 - Intel Brookdale-G NorthBridge Configuration
 - Primary Video Device
 - Graphics Mode Select
 - Graphics Aperture Size
 - Search for MDA Resources
 - Intel ICH4 SouthBridge Configuration
 - ICH4 Dev31 Func1, IDE
 - ICH4 Dev31 Func3, SMBUS
 - ICH4 Dev29 Func0, USB#1
 - ICH4 Dev29 Func7, ECHI
 - LPC 4Eh-4Fh Decode/LPC 2Eh/2Fh Decode
 - On Board Lan
 - ISA BUS
 - IOAPIC
 - Extended IOAPIC
 - CPU B.I.S.T.
 - ICH4 DMA Collection
 - PC/PCIB Select
 - DMA Types 0, 1, 2, 3, 5, 6 and 7
- Select **Boot** to make changes to Boot Setup parameters as described in the *Boot Setup* chapter of this manual. The following options may be modified:
 - Boot Settings Configuration
 - Quick Boot
 - Quiet Boot

- AddOn ROM Display Mode
- Bootup Num-Lock
- PS/2 Mouse Support
- System Keyboard
- Boot To OS/2
- Wait For 'F1' If Error
- Hit 'DEL' Message Display
- Boot Device Priority
- Hard Disk Drives
- Removable Devices
- ATAPI CDROM Drives
- Interrupt 19 Capture
- Select **Security** to establish or change the supervisor or user password or to enable boot sector virus protection. These functions are described later in this chapter. The following options may be modified:
 - Change Supervisor Password
 - User Access Level
 - Password Check
 - Change User Password
 - Unattended Start
 - Password Check
 - Clear User Password
 - Boot Sector Virus Protection
- Select **Exit** to save or discard changes you have made to AMIBIOS parameters or to load the Optimal or Failsafe default settings. These functions are described later in this chapter. The following options are available:
 - Save Changes and Exit
 - Discard Changes and Exit
 - Discard Changes
 - Load Optimal Defaults
 - Load Failsafe Defaults

SECURITY SETUP When you select **Security** from the BIOS Setup Utility Main Menu, the following Setup screen displays:

| BIOS SETUP UTILITY | |
|--|---|
| Main | Advanced PCI PnP Chipset Boot Security Exit |
| Security Settings <hr/> Supervisor Password :Not Installed User Password :Not Installed Change Supervisor Password Change User Password Clear User Password Boot Sector Virus Protection [Disabled] | Install or Change the password. ←→ Select Screen ↑↓ Select Item Enter Change F1 General Help F10 Save and Exit ESC Exit |
| vxx.xx (C) Copyright 1985-2002, American Megatrends, Inc. | |

Security Setup Screen

When you display the Security Setup screen, the format is similar to the sample shown above. Highlight the option you wish to change and press <Enter>.

NOTE: The values on this screen do not necessarily reflect the values appropriate for your SBC. Refer to the explanations below for specific instructions about entering correct information.

SECURITY SETUP OPTIONS The Security Setup options allow you to establish, change or clear the supervisor or user password and to enable boot sector virus protection.

The descriptions for the system options listed below show the values as they appear if you have not changed them yet. Once values have been defined, they display each time the BIOS Setup Utility is run.

CHANGE SUPERVISOR PASSWORD This option allows you to establish a supervisor password, change the current password or disable the password prompt by entering a null password. The password is stored in CMOS RAM.

If you have signed on under the user password, this option is *not* available.

The **Change Supervisor Password** feature can be configured so that a password must be entered each time the system boots or just when a user attempts to enter the BIOS Setup Utility.

NOTE: The null password is the system default and is in effect if a password has not been assigned or if the CMOS has been corrupted. In this case, the "Enter CURRENT Password" prompt is bypassed when you boot the system, and you must establish a new password.

If you select the **Change Supervisor Password** option, the following window displays:

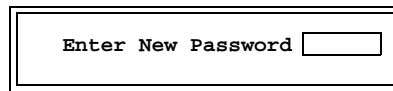

A rectangular dialog box with a double-line border. The text "Enter New Password" is displayed in a monospaced font, followed by a small rectangular input field.

This is the message which displays before you have established a password, or if the last password entered was the null password. If a password has already been established, you are asked to enter the *current* password before being prompted to enter the *new* password.

Type the new password and press **<Enter>**. The password cannot exceed six (6) characters in length. The screen displays an asterisk (*) for each character you type.

After you have entered the new password, the following window displays:

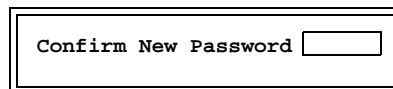

A rectangular dialog box with a double-line border. The text "Confirm New Password" is displayed in a monospaced font, followed by a small rectangular input field.

Re-key the new password as described above.

If the password confirmation is miskeyed, AMIBIOS Setup displays the following message:

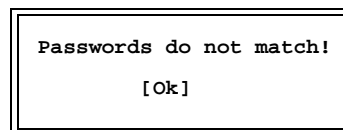

A rectangular dialog box with a double-line border. The text "Passwords do not match!" is displayed in a monospaced font, followed by "[Ok]" centered below it.

No retries are permitted; you must restart the procedure.

If the password confirmation is entered correctly, the following message displays:

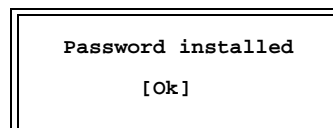

A rectangular dialog box with a double-line border. The text "Password installed" is displayed in a monospaced font, followed by "[Ok]" centered below it.

Press the <Enter> key to return to the Security screen. **Installed** displays on the screen next to the **Supervisor Password** option, indicating the password has been accepted. This setting will remain in effect until the supervisor password is either disabled or discarded upon exiting the BIOS Setup Utility.

If you have created a new password, be sure to select **Exit**, then **Save Changes and Exit** to save the password. The password is then stored in CMOS RAM. The next time the system boots, you are prompted for the password.

NOTE: Be sure to keep a record of the new password each time it is changed. If you forget it, use the Password Clear jumper to reset it to the default (null password). See the *Specifications* chapter of this manual for details.

If a password has been established, the following options and their default values are added to the screen:

| | |
|-------------------|---------------|
| User Access Level | [Full Access] |
| Password Check | [Setup] |

User Access Level

This option allows you to define the level of access the user will have to the system.

The Setup screen displays the system option:

| | |
|--------------------------|----------------------|
| User Access Level | [Full Access] |
|--------------------------|----------------------|

Four options are available:

- Select **No Access** to prevent user access to the BIOS Setup Utility.
- Select **View Only** to allow access to the BIOS Setup Utility for viewing, but to prevent the user from changing any of the fields.
- Select **Limited** to allow the user to change only a limited number of options, such as Date and Time.
- Select **Full Access** to allow the user full access to change any option in the BIOS Setup Utility.

Password Check

This option determines when a password is required for access to the system.

The Setup screen displays the system option:

| | |
|-----------------------|----------------|
| Password Check | [Setup] |
|-----------------------|----------------|

Two options are available:

- Select **Setup** to have the password prompt appear only when an attempt is made to enter the BIOS Setup Utility program.
- Select **Always** to have the password prompt appear each time the system is powered on.

DISABLING THE SUPERVISOR PASSWORD

To *disable* password checking so that the password prompt does not appear, you may create a null password selecting the **Change Supervisor Password** function and pressing <Enter> without typing in a new password. You will be asked to enter the current password before being allowed to enter the null password. After you press <Enter> at the **Enter New Password** prompt, the following message displays:

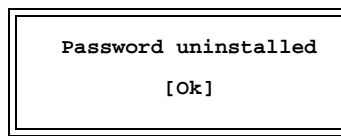

CHANGE USER PASSWORD

The **Change User Password** option is similar in functionality to the **Change Supervisor Password** and displays the same messages. If you have signed on under the user password, the **Change Supervisor Password** function is not available for modification.

If a user password has been established, the **Password Check** option and its default value is added to the screen. This option determines when a user password is required for access to the system. For details, refer to the description for **Password Check** under the **Change Supervisor Password** heading earlier in this section.

CLEAR USER PASSWORD

This option allows you to clear the user password. It disables the user password by entering a null password.

If you select the **Clear User Password** option, the following window displays:

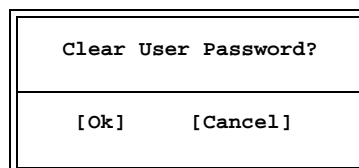

You have two options:

- Select **Ok** to clear the user password.
- Select **Cancel** to leave the current user password in effect.

BOOT SECTOR VIRUS PROTECTION

This option allows you to request AMIBIOS to issue a warning when any program or virus issues a Disk Format command or attempts to write to the boot sector of the hard disk drive.

The Setup screen displays the system option:

Boot Sector Virus Protection **[Disabled]**

Available options are:

Disabled

Enabled

NOTE: You should *not* enable boot sector virus protection when formatting a hard drive.

This page intentionally left blank.

EXIT MENU

When you select **Exit** from the BIOS Setup Utility Main Menu, the following screen displays:

| BIOS SETUP UTILITY | | | | | | |
|--|----------|--------|---------|--|----------|------|
| Main | Advanced | PCIPnP | Chipset | Boot | Security | Exit |
| Exit Options | | | | Exit system setup after saving the changes. | | |
| Save Changes and Exit | | | | F10 key can be used this operation. | | |
| Discard Changes and Exit | | | | | | |
| Discard Changes | | | | | | |
| Load Optimal Defaults | | | | | | |
| Load Failsafe Defaults | | | | | | |
| | | | | ←→ Select Screen ↑↓ Select Item Enter Go to Sub Screen F1 General Help F10 Save and Exit ESC Exit | | |
| vxx.xx (C)Copyright 1985-2002, American Megatrends, Inc. | | | | | | |

Exit Menu Screen

When you display the Exit Menu screen, the format is similar to the sample shown above. Highlight the option you wish to select and press <Enter>.

EXIT MENU OPTIONS

When you are running the BIOS Setup Utility program, you may either save or discard changes you have made to AMIBIOS parameters, or you may load the Optimal or Failsafe default settings.

Save Changes and Exit

The features selected and configured in the Setup screens are stored in the CMOS when this option is selected. The CMOS checksum is calculated and written to the CMOS. Control is then passed back to the AMIBIOS and the booting process continues, using the new CMOS values.

If you select the **Save Changes and Exit** option, the following window displays:

| | |
|--|----------|
| Save configuration changes and exit setup? | |
| [Ok] | [Cancel] |

You have two options:

- Select **Ok** to save the system parameters and continue with the booting process.
- Select **Cancel** to return to the BIOS Setup Utility screen.

Discard Changes and Exit

When the **Discard Changes and Exit** option is selected, the BIOS Setup Utility exits *without* saving the changes in the CMOS. Control is then passed back to AMIBIOS and the booting process continues, using the previous CMOS values.

If you select the **Discard Changes and Exit** option, the following window displays:

| | |
|---------------------------------|----------|
| Discard changes and exit setup? | |
| [Ok] | [Cancel] |

You have two options:

- Select **Ok** to continue the booting process without writing any changes to the CMOS.
- Select **Cancel** to return to the BIOS Setup Utility screen.

Discard Changes

When the **Discard Changes** option is selected, the BIOS Setup Utility resets any parameters you have changed back to the values at which they were set when you entered the Setup Utility. Control is then passed back to the BIOS Setup Utility screen.

If you select the **Discard Changes** option, the following window displays:

| | |
|------------------|----------|
| Discard changes? | |
| [Ok] | [Cancel] |

You have two options:

- Select **Ok** to reset any parameters you have changed back to the values at which they were set when you entered the BIOS Setup Utility. This option then returns you to the BIOS Setup Utility screen.
- Select **Cancel** to return to the BIOS Setup Utility screen *without* discarding any changes you have made.

Load Optimal or Failsafe Defaults

Each AMIBIOS Setup option has two default settings (Optimal and Failsafe). These settings can be applied to all AMIBIOS Setup options when you select the appropriate configuration option from the BIOS Setup Utility Main Menu.

You can use these configuration options to quickly set the system configuration parameters which should provide the best performance characteristics, or you can select a group of settings which have a better chance of working when the system is having configuration-related problems.

Load Optimal Defaults

This option allows you to load the Optimal default settings. These settings are best-case values which should provide the best performance characteristics. If CMOS RAM is corrupted, the Optimal settings are loaded automatically.

If you select the **Load Optimal Defaults** option, the following window displays:

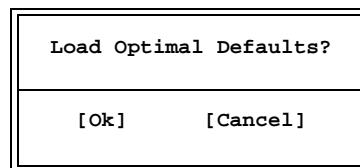

You have two options:

- Select **Ok** to load the Optimal default settings.
- Select **Cancel** to leave the current values in effect.

Load Failsafe Defaults

This option allows you to load the Failsafe default settings when you cannot boot your computer successfully. These settings are more likely to configure a workable computer. They may not provide optimal performance, but are the most stable settings. You may use this option as a diagnostic aid if your system is behaving erratically. Select the Failsafe settings and then try to diagnose the problem after the computer boots.

If you select the **Load Failsafe Defaults** option, the following window displays:

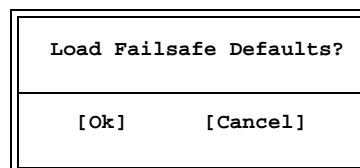

You have two options:

- Select **Ok** to load the Failsafe default settings.
- Select **Cancel** to leave the current values in effect.

Chapter 4 Advanced Setup

ADVANCED SETUP When you select **Advanced** from the BIOS Setup Utility Main Menu, the following Setup screen displays:

| BIOS SETUP UTILITY | | | | | | |
|--|----------|--------|---------|---|----------|------|
| Main | Advanced | PCIPnP | Chipset | Boot | Security | Exit |
| Advanced Settings | | | | Options for CPU. | | |
| <p>WARNING: Setting wrong values in below sections may cause system to malfunction.</p> <p>> CPU Configuration > IDE Configuration > Floppy Configuration > SuperIO Configuration > DMI Event Logging > Remote Access Configuration > USB Configuration</p> | | | | | | |
| | | | | <p>←→ Select Screen ↑↓ Select Item Enter Go to Sub Screen F1 General Help F10 Save and Exit ESC Exit</p> | | |
| vxx.xx (C)Copyright 1985-2002, American Megatrends, Inc. | | | | | | |

Advanced Setup Screen

When you display the Advanced Setup screen, the format is similar to the sample shown above, allowing you to continue to subscreens designed to change parameters for each of the Advanced Setup options. Highlight the option you wish to change and press <Enter> to proceed to the appropriate subscreen.

NOTE: The values on the Advanced Setup subscreens do not necessarily reflect the values appropriate for your SBC. Refer to the explanations following each screen for specific instructions about entering correct information.

ADVANCED SETUP OPTIONS

NOTE: Do not change the values for any Advanced Setup option unless you understand the impact on system operation. Depending on your system configuration, selection of other values may cause unreliable system operation.

CPU Configuration

The **CPU Configuration** subscreen provides you with information about the processor in your system. The following option is displayed:

- Ratio CMOS Setting

IDE Configuration

The options on the **IDE Configuration** subscreens allow you to set up or modify parameters for your IDE controller and hard disk drive(s). The following options may be modified:

- OnBoard PCI IDE Controller
- Primary IDE Master/Primary IDE Slave
 - Type
 - LBA/Large Mode
 - Block (Multi-Sector Transfer)
 - PIO Mode
 - DMA Mode
 - S.M.A.R.T.
 - 32Bit Data Transfer
 - ARMD Emulation Type
- Secondary IDE Master/Secondary IDE Slave
 - (see options above)
- Hard Disk Write Protect
- IDE Detect Time Out (Sec)
- ATA(PI) 80Pin Cable Detection

Floppy Configuration

The options on the **Floppy Configuration** subscreen allow you to set up or modify parameters for your floppy disk drive(s). The following options may be modified:

- Floppy A/Floppy B

SuperIO Configuration

The options on the **SuperIO Configuration** subscreen allow you to set up or modify parameters for your on-board peripherals. The following options may be modified:

- OnBoard Floppy Controller
- Serial Port1 Address/Serial Port2 Address

- Serial Port2 IRQ
- Serial Port2 Mode
- Parallel Port Address
 - Parallel Port Mode
 - Parallel Port IRQ

DMI Event Logging

The options on the **DMI Event Logging** subscreen allow you to set up or modify parameters for using the event log, which allows you to log errors and other events which occur in the system. The following options may be modified:

- View Event Log
- Mark All Events as Read
- Clear Event Log
- Event Log Statistics

Remote Access Configuration

The options on the **Remote Access Configuration** subscreen allow you to set up or modify parameters for configuring remote access type and parameters. The following options may be modified:

- Remote Access
- Serial Port Number
- Serial Port Mode
- Post-Boot Support

USB Configuration

The options on the **USB Configuration** subscreen allow you to set up or modify parameters for your on-board peripherals. The following options may be modified:

- USB Configuration
 - USB Function
 - Legacy USB Support
 - USB ZIP Emulation Type
 - USB Beep Message

Saving and Exiting

When you have made all desired changes to **Advanced Setup**, you may make changes to other Setup options by using the right and left arrow keys to access other menus. When you have made all of your changes, you may save them by selecting the **Exit** menu, or you may press <Esc> at any time to exit the BIOS Setup Utility without saving the changes.

**CPU
CONFIGURATION
SETUP**

When you select **CPU Configuration** from the Advanced Setup Screen, the following Setup screen displays:

| | |
|---|---|
| BIOS SETUP UTILITY | |
| Advanced | |
| Configure advanced CPU settings <hr/> Manufacturer : Intel Brand String : Intel(R) Pentium(R) 4 Family CPU 2 Real Frequency : 2400MHz (18 x 133MHz) CPU ID :0F24h Ratio Status: Locked Ratio Actual Value : 18 Ratio CMOS Setting: [8] | Sets the ratio between CPU Core Clock and the FSB Frequency. NOTE: If an invalid ratio is set in CMOS then actual and setpoint values may differ. ←→ Select Screen ↑↓ Select Item Enter Update F1 General Help F10 Save and Exit ESC Exit |
| vxx.xx (C)Copyright 1985-2002, American Megatrends, Inc. | |

CPU Configuration Screen

When you display the CPU Configuration screen, the format is similar to the sample shown above. Highlight the option you wish to change and press <Enter> to display the available settings. Select the appropriate setting and press <Enter> again to accept the highlighted value.

**CPU
CONFIGURATION
SETUP OPTIONS**

The description for the system options listed below show the values as they appear if you have not yet run Advanced Setup. Once you change the settings, the new settings display each time Advanced Setup is run.

Ratio CMOS Setting

The processor is locked at the correct processor speed before shipment. Changing the **Ratio CMOS Setting** option to another value has no effect on actual processor speed.

The Setup screen displays the system option:

Ratio CMOS Setting [##]

where ## is the CPU ratio setting for the processor speed (e.g., 8 indicates 800MHz, 28 indicates 2.8GHz, etc.)

This page intentionally left blank.

IDE CONFIGURATION

When you select **IDE Configuration** from the Advanced Setup Menu, the following Setup screen displays:

| BIOS SETUP UTILITY | |
|---|--|
| Advanced | |
| <p>IDE Configuration</p> <hr/> <p>OnBoard PCI IDE Controller [Both]</p> <p>> Primary IDE Master : [Hard Disk]</p> <p>> Primary IDE Slave : [Hard Disk]</p> <p>> Secondary IDE Master : [ATAPI CDROM]</p> <p>> Secondary IDE Slave : [ARMD]</p> <p>Hard Disk Write Protect [Disabled]</p> <p>IDE Detect Time Out (Sec) [35]</p> <p>ATA(PI) 80Pin Cable Detection [Host & Device]</p> | <p>DISABLED: disables the integrated IDE Controller.</p> <p>PRIMARY: enables only the Primary IDE Controller.</p> <p>SECONDARY: enables only the Secondary IDE Controller.</p> <p>BOTH: enables both IDE Controllers.</p> <p>←→ Select Screen</p> <p>↑↓ Select Item</p> <p>+ - Change Option</p> <p>F1 General Help</p> <p>F10 Save and Exit</p> <p>ESC Exit</p> |
| vxx.xx (C)Copyright 1985-2002, American Megatrends, Inc. | |

IDE Configuration Screen

When you display the IDE Configuration screen, the format is similar to the sample shown above. Highlight the option you wish to change and press <Enter> to display the available settings. Select the appropriate setting and press <Enter> again to accept the highlighted value.

Some of the options on this screen allow you to continue to subscreens designed to change parameters for that particular option. Highlight the option you wish to change and press <Enter> to proceed to the appropriate subscreen.

IDE CONFIGURATION OPTIONS

The descriptions for the system options listed below show the values as they appear if you have not run the BIOS Setup Utility program yet. Once values have been defined, they display each time the BIOS Setup Utility is run.

OnBoard PCI IDE Controller

This option specifies whether or not the on-board integrated drive electronics (IDE) controllers are to be used.

The Setup screen displays the system option:

OnBoard PCI IDE Controller [Both]

Available options are:

Disabled
 Primary
 Secondary
 Both

Primary IDE Master/Primary IDE Slave Secondary IDE Master/Secondary IDE Slave

The SBC has an enhanced IDE (EIDE) interface which can support up to four IDE disk drives through a primary and secondary controller in a master/slave configuration. This EIDE interface allows disk drives greater than 528MB to be used. Each of the four drives may be a different type.

Devices attached to the primary and secondary controllers are detected automatically by AMIBIOS and displayed on the IDE Configuration screen.

The Setup screen displays the system options:

| | |
|-----------------------------|-----------------------|
| Primary IDE Master | [Hard Disk] |
| Primary IDE Slave | [Hard Disk] |
| Secondary IDE Master | [ATAPI CDROM] |
| Secondary IDE Slave | [Not Detected] |

To view and/or change parameters for any IDE device, press <Enter> to proceed to the IDE Device Setup screen, which is described later in this section.

Hard Disk Write Protect

This option allows you to disable or enable device write protection. Write protection will be effective only if the device is accessed through the BIOS.

The Setup screen displays the system option:

| | |
|--------------------------------|-------------------|
| Hard Disk Write Protect | [Disabled] |
|--------------------------------|-------------------|

Available options are:

Disabled
 Enabled

IDE Detect Time Out (Sec)

This option allows you to select the time-out value (in seconds) for detecting an ATA/ATAPI device.

The Setup screen displays the system option:

| | |
|----------------------------------|-------------|
| IDE Detect Time Out (Sec) | [35] |
|----------------------------------|-------------|

Available options are:

0
5
10
15
20
25
30
35

ATA(PI) 80Pin Cable Detection

This option allows you to select the mechanism for detecting an 80-pin ATA(PI) cable.

The Setup screen displays the system option:

ATA(PI) 80Pin Cable Detection [Host & Device]

Available options are:

Host & Device
Host
Device

This page intentionally left blank.

IDE DEVICE SETUP When you select one of the IDE devices from the **IDE Configuration** screen, a Setup screen similar to the following displays:

| BIOS SETUP UTILITY | |
|--|--|
| Advanced | |
| Primary IDE Master <hr/> Device :Hard Disk Vendor :ST38418A Size :8.6GB LBA Mode :Supported Block Mode:32Sectors PIO Mode :4 Async DMA :MultiWord DMA-2 Ultra DMA :Ultra DMA-2 S.M.A.R.T.:Supported <hr/> Type [Auto] LBA/Large Mode [Auto] Block (Multi-Sector Transfer) [Auto] PIO Mode [Auto] DMA Mode [Auto] S.M.A.R.T. [Auto] 32Bit Data Transfer [Disabled] ARMD Emulation Type [Auto] | Select the type of device connected to the system. ←→ Select Screen ↑↓ Select Item +- Change Option F1 General Help F10 Save and Exit ESC Exit |
| vxx.xx (C)Copyright 1985-2002, American Megatrends, Inc. | |

IDE Device Screen

When you display the IDE Device subscreen, the format is similar to the sample shown above. The data displayed on the top portion of the screen details the parameters detected by AMIBIOS for the specified device and may not be modified. The data displayed on the bottom portion of the screen may be modified.

The drive information which displays the first time the BIOS Setup Utility is run indicates the drive(s) on your system which were detected by AMIBIOS upon initial bootup.

IDE DEVICE SETUP OPTIONS The following options are available for each of the four IDE devices on the primary and secondary IDE controllers:

Type

This option allows you to specify what type of device is on the IDE controller.

The Setup screen displays the system option:

Type [Auto]

Available options are:

Not Installed
Auto
CDROM
ARMD

If **Not Installed** is selected, the other options on the bottom portion of this screen do not display. If **CDROM** is selected, the **ARMD Emulation Type** option is not available.

LBA/Large Mode

This option allows you to enable IDE LBA (Logical Block Addressing) Mode for the specified IDE drive. Data is accessed by block addresses rather than by the traditional cylinder-head-sector format. This allows you to use drives larger than 528MB.

The Setup screen displays the system option:

LBA/Large Mode **[Auto]**

Two options are available:

- Select **Disabled** to have AMIBIOS use the physical parameters of the hard disk and do no translation to logical parameters. The operating system which uses the parameter table will then see only 528MB of hard disk space even if the drive contains more than 528MB.
- Select **Auto** to enable LBA mode and translate the physical parameters of the drive to logical parameters. LBA Mode must be supported by the drive and the drive must have been formatted with LBA Mode enabled.

Block (Multi-Sector Transfer) Mode

This option supports transfer of multiple sectors to and from the specified IDE drive. Block mode boosts IDE drive performance by increasing the amount of data transferred during an interrupt.

If **Block Mode** is set to **Disabled**, data transfers to and from the device occur one sector at a time.

The Setup screen displays the system option:

Block (Multi-Sector Transfer) **[Auto]**

Available options are:

Disabled
Auto

PIO Mode

IDE Programmed I/O (PIO) Mode programs timing cycles between the IDE drive and the programmable IDE controller. As the PIO mode increases, the cycle time decreases.

Set the **PIO Mode** option to **Auto** to have AMIBIOS select the PIO mode used by the IDE drive being configured. If you select a specific value for the PIO mode, you must make absolutely certain that you are selecting the PIO mode supported by the IDE drive being configured.

The Setup screen displays the system option:

PIO Mode **[Auto]**

Available options are:

Auto
0
1
2
3
4

DMA Mode

This option allows you to select DMA Mode for the device.

The Setup screen displays the system option:

DMA Mode **[Auto]**

Available options are:

Auto
SWDMA0 (SingleWord DMA 0 - 2)
SWDMA1
SWDMA2
MWDMA0 (MultiWord DMA 0 - 2)
MWDMA1
MWDMA2
UDMA0 (UltraDMA 0 - 4)
UDMA1
UDMA2
UDMA3
UDMA4

S.M.A.R.T.

This option allows AMIBIOS to use the SMART (Self-Monitoring Analysis and Reporting Technology) protocol for reporting server system information over a network.

The Setup screen displays the system option:

S.M.A.R.T. **[Auto]**

Available options are:

Auto
Disabled
Enabled

32Bit Data Transfer

Hard disk drives connected to the SBC via the ISA Bus transfer data 16 bits at a time. An IDE drive on the PCI Local Bus can use a 32-bit data path.

If the **32Bit Data Transfer** parameter is set to **Enabled**, AMIBIOS enables 32-bit data transfers. If the host controller does not support 32-bit transfer, this feature must be set to **Disabled**.

The Setup screen displays the system option:

32Bit Data Transfer **[Disabled]**

Available options are:

Disabled
Enabled

ARMD Emulation Type

This option specifies the type of ARMD (ATAPI Removable Media Device) emulation used for a non-disk device attached to the specified IDE device.

If the option is set to **Auto**, AMIBIOS automatically determines the proper emulation type and will support particular storage devices with ATAPI interface.

If **CDROM** is selected in the **Type** field, this option is not available for modification.

The Setup screen displays the system options:

ARMD Emulation Type **[Auto]**

Available options are:

Auto
Floppy
Hard Disk

FLOPPY CONFIGURATION

When you select **Floppy Configuration** from the Advanced Setup Menu, the following Setup screen displays:

| | |
|--|--|
| BIOS SETUP UTILITY | |
| Advanced | |
| <p>Floppy Configuration</p> <hr/> <p>Floppy A [1.44 MB 3½"] Floppy B [Disabled]</p> | <p>Select the type of floppy drive connected to the system.</p> <p>←→ Select Screen ↑↓ Select Item +- Change Option F1 General Help F10 Save and Exit ESC Exit</p> |
| vxx.xx (C)Copyright 1985-2002, American Megatrends, Inc. | |

Floppy Configuration Screen

When you display the Floppy Configuration screen, the format is similar to the sample shown above. Highlight the option you wish to change and press <Enter> to display the available settings. Select the appropriate setting and press <Enter> again to accept the highlighted value.

The drive information which displays the first time the BIOS Setup Utility is run indicates the drive(s) on your system which were detected by AMIBIOS upon initial bootup.

FLOPPY CONFIGURATION OPTIONS

The descriptions for the system options listed below show the values as they appear if you have not run the BIOS Setup Utility program yet. Once values have been defined, they display each time the BIOS Setup Utility is run.

Floppy A/Floppy B

The floppy drive(s) in your system can be configured using these options. The **Disabled** option can be used for diskless workstations.

The Setup screen displays the system options:

| | |
|-----------------|----------------------|
| Floppy A | [1.44 MB 3½"] |
| Floppy B | [Disabled] |

Available options are:

- Disabled
- 360 KB 5¼"
- 1.2 MB 5¼"
- 720 KB 3½"
- 1.44MB 3½"
- 2.88MB 3½"

**SUPERIO
CONFIGURATION**

When you select **SuperIO Configuration** from the Advanced Setup Menu, the following Setup screen displays:

| SuperIO Chipset Smc27X | |
|---|--|
| Advanced | |
| Configure Smc27X Serial Port(s) and Parallel Port | |
| OnBoard Floppy Controller | [Enabled] |
| Serial Port1 Address | [3F8/IRQ4] |
| Serial Port2 Address | [2F8/IRQ3] |
| Serial Port2 Irq | [IRQ4] |
| Serial Port2 Mode | [Normal] |
| Parallel Port Address | [378] |
| Parallel Port Mode | [Normal] |
| Parallel Port IRQ | [IRQ7] |
| | ←→ Select Screen ↑↓ Select Item +- Change Option F1 General Help F10 Save and Exit ESC Exit |
| vxxx.xx (C)Copyright 1985-2002, American Megatrends, Inc. | |

SuperIO Configuration Screen

When you display the SuperIO Configuration screen, the format is similar to the sample shown above. Highlight the option you wish to change and press <Enter> to display the available settings. Select the appropriate setting and press <Enter> again to accept the highlighted value.

**SUPERIO
CONFIGURATION
OPTIONS**

The descriptions for the system options listed below show the values as they appear if you have not run the BIOS Setup Utility program yet. Once values have been defined, they display each time the BIOS Setup Utility is run.

OnBoard Floppy Controller

The on-board floppy drive controller may be enabled or disabled using this option.

The Setup screen displays the system option:

OnBoard Floppy Controller [Enabled]

Available options are:

- Disabled
- Enabled

Serial Port1 Address/Serial Port2 Address

Each of these options enables the specified serial port on the SBC and establishes the base I/O address and the number of the interrupt request for the port.

The Setup screen displays the system option:

| | |
|-----------------------------|-------------------|
| Serial Port1 Address | [3F8/IRQ4] |
| Serial Port2 Address | [2F8/IRQ3] |

Available options are:

- Disabled
- 3F8/IRQ4
- 3E8/IRQ4
- 2F8/IRQ3
- 2E8/IRQ3

NOTE: The values available for each on-board serial port may vary, depending on the setting previously selected for the other on-board serial port and any off-board serial ports. If an I/O address is assigned to another serial port, AMIBIOS automatically omits that address from the values available.

If the system has off-board serial ports which are configured to specific starting I/O ports via jumper settings, AMIBIOS configures the on-board serial ports to avoid conflicts.

AMIBIOS checks the ISA Bus for serial ports. Any off-board serial ports found on the ISA Bus are left at their assigned addresses. Serial Port1, the first on-board serial port, is configured with the first available address and Serial Port2, the second on-board serial port, is configured with the next available address. The default address assignment order is 3F8H, 2F8H, 3E8H, 2E8H. Note that this same assignment order is used by AMIBIOS to place the active serial port addresses in lower memory (BIOS data area) for configuration as logical COM devices.

For example, if there is one off-board serial port on the ISA Bus and its address is set to 2F8H, Serial Port1 is assigned address 3F8H and Serial Port2 is assigned address 3E8H. Configuration is then as follows:

- COM1 - Serial Port1 (at 3F8H)
- COM2 - off-board serial port (at 2F8H)
- COM3 - Serial Port2 (at 3E8H)

If **Serial Port2 Address** is set to **Disabled**, the **Serial Port2 IRQ** and **Serial Port2 Mode** options are not available.

Serial Port2 IRQ

If the **Serial Port2 Address** option is set to **Disabled**, this option is not available for modification.

The Setup screen displays the system option:

Serial Port2 IRQ **[IRQ4]**

Available options are:

Disabled
IRQ3
IRQ4

Serial Port2 Mode

If the **Serial Port2 Address** option is set to **Disabled**, this option is not available for modification.

The Setup screen displays the system option:

Serial Port2 Mode **[Normal]**

Available options are:

Normal
IrDA Sir-A
ASK IR
IrDA Sir-B
IrDA HDLC
IrDA 4PPM
Consumer
Raw Ir

Parallel Port Address

This option enables the parallel port on the SBC and establishes the base I/O address for the port.

The Setup screen displays the system option:

Parallel Port Address **[378]**

Available options are:

Disabled
378
278
3BC

AMIBIOS checks the ISA Bus for off-board parallel ports. Any parallel ports found on the ISA Bus are left at their assigned addresses. The on-board Parallel Port is automatically configured with the first available address not used by an off-board parallel port.

If this option is set to **Disabled**, the **Parallel Port Mode** and **Parallel Port IRQ** options are not available.

Parallel Port Mode

This option specifies the parallel port mode. ECP and EPP are both bidirectional data transfer schemes which adhere to the IEEE P1284 specifications.

If the **Parallel Port Address** option is set to **Disabled**, this option is not available for modification.

The Setup screen displays the system option:

Parallel Port Mode **[Normal]**

Four options are available:

- Select **Normal** to use normal parallel port mode.
- Select **Bi-Directional** to use bi-directional parallel port mode.
- Select **EPP** to allow the parallel port to be used with devices which adhere to the Enhanced Parallel Port (EPP) specification. EPP uses the existing parallel port signals to provide asymmetric bidirectional data transfer driven by the host device.
- Select **ECP** to allow the parallel port to be used with devices which adhere to the Extended Capabilities Port (ECP) specification. ECP uses the DMA protocol to achieve transfer rates of approximately 2.5MB/second. ECP provides symmetric bidirectional communication.

Parallel Port IRQ

This option specifies the interrupt request (IRQ) which is used by the parallel port.

If the **Parallel Port Address** option is set to **Disabled**, this option is not available for modification.

The Setup screen displays the system option:

Parallel Port IRQ **[IRQ7]**

Available options are:

IRQ5
IRQ7

DMI EVENT LOGGING

When you select **DMI Event Logging** from the Advanced Setup Menu, the following Setup screen displays:

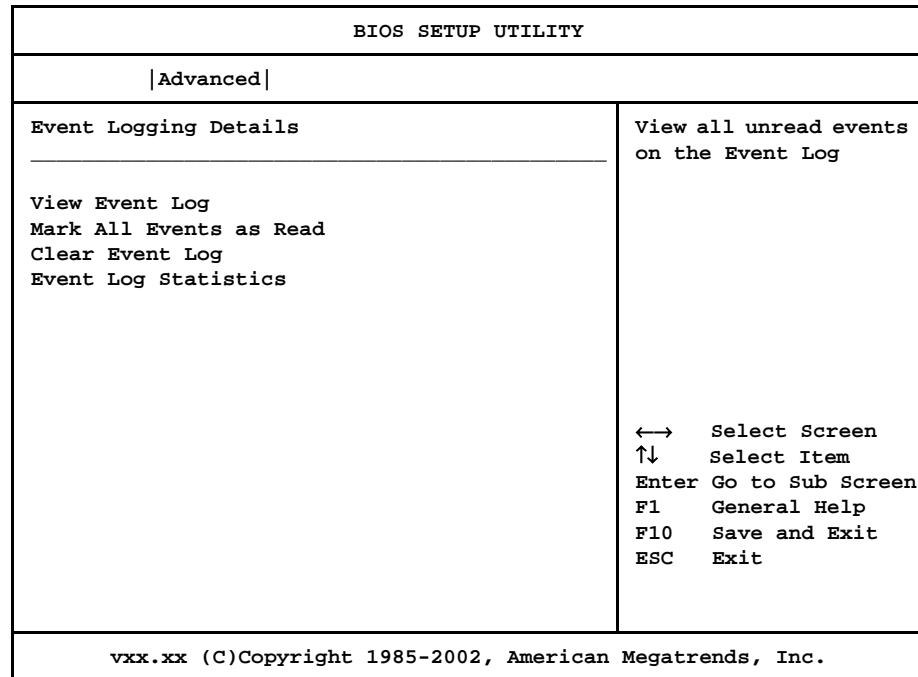

DMI Event Logging Screen

When you display the DMI Event Logging screen, the format is similar to the sample shown above. Highlight the option you wish to access and press <Enter>. After you have finished, select the appropriate response.

DMI EVENT LOGGING OPTIONS

View Event Log

When you select this option, a window similar to the following displays showing unread events in the Event Log:

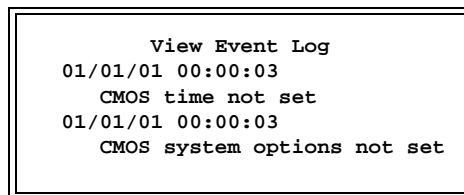

When you have finished viewing the Event Log, press <Esc> to continue.

Mark All Events As Read

After you have reviewed the events in the event log, you may select this option, which allows you to mark all unread event log entries as having been read.

The following window displays:

| | |
|------------------------------|----------|
| Mark all events as read now? | |
| [Ok] | [Cancel] |

Selecting **Ok** marks all unread entries currently in the event log file as having been read. The next time you select the **View Event Log** option, only the new, unmarked events are displayed.

Clear Event Log

This option specifies whether or not the event log should be cleared.

The following window displays:

| | |
|----------------------|----------|
| Clear Event Log now? | |
| [Ok] | [Cancel] |

Selecting **Ok** discards all entries in the Event Log. The next time you select the **View Event Log** option, only new entries will display.

Event Log Statistics

When you select this option, a window similar to the following displays showing statistics for events which have been logged:

| |
|------------------------|
| Event Log Statistics |
| Total size (in events) |
| 63 |
| Free size (in events) |
| 62 |
| Unread events |
| 01 |

When you have finished viewing the Event Log statistics, press <Esc> to continue.

REMOTE ACCESS CONFIGURATION

When you select **Remote Access Configuration** from the Advanced Setup Menu, the following Setup screen displays:

| BIOS SETUP UTILITY | |
|--|--|
| Advanced | |
| Configure Remote Access Type and Parameters | Select Remote Access type |
| Remote Access [Serial] | |
| Serial Port Number [COM1] | |
| Serial Port Mode [57600 8,n,1] | |
| Post-Boot Support [Disabled] | |
| | ←→ Select Screen ↑↓ Select Item +- Change Option F1 General Help F10 Save and Exit ESC Exit |
| vxx.xx (C)Copyright 1985-2002, American Megatrends, Inc. | |

Remote Access Configuration Screen

When you display the Remote Access Configuration screen, the format is similar to the sample shown above. Highlight the option you wish to change and press <Enter> to display the available settings. Select the appropriate setting and press <Enter> again to accept the highlighted value.

REMOTE ACCESS CONFIGURATION OPTIONS

The descriptions for the system options listed below show the values as they appear if you have not run the BIOS Setup Utility program yet. Once values have been defined, they display each time the BIOS Setup Utility is run.

Remote Access

This option allows you to use a terminal connected to the serial port of the SBC to control changes to the BIOS settings.

The Setup screen displays the system option:

Remote Access [Disabled]

Available options are:

- Disabled
- Serial

If this option is set to **Disabled**, the **Serial Port Number**, **Serial Port Mode** and **Post-Boot Support** options are not available.

Serial Port Number

This option specifies the serial port on which remote access is to be enabled.

If the **Remote Access** option is set to **Disabled**, this option is not available.

The Setup screen displays the system option:

Serial Port Number **[COM1]**

Available options are:

COM1
COM2

Serial Port Mode

This option specifies settings for the serial port on which remote access is enabled. The settings indicate baud rate, eight bits per character, no parity and one stop bit.

If the **Remote Access** option is set to **Disabled**, this option is not available.

The Setup screen displays the system option:

Serial Port Mode **[57600 8,n,1]**

Available options are:

115200 8,n,1
57600 8,n,1
19200 8,n,1

Post-Boot Support

This option specifies whether or not to keep redirection active after booting to DOS.

If the **Remote Access** option is set to **Disabled**, this option is not available.

The Setup screen displays the system option:

Post-Boot Support **[Disabled]**

Two options are available:

- Select **Disabled** to deactivate redirection.
- Select **Enabled** to keep redirection active.

USB CONFIGURATION

When you select **USB Configuration** from the Advanced Setup Menu, the following Setup screen displays:

| BIOS SETUP UTILITY | |
|--|---|
| Advanced | |
| USB Configuration <hr/> USB Function [Enabled] Legacy USB Support [Auto] USB ZIP Emulation Type [Auto] USB Beep Message [Enabled] | Enables USB host controllers. ←→ Select Screen ↑↓ Select Item +- Change Option F1 General Help F10 Save and Exit ESC Exit |
| vxx.xx (C)Copyright 1985-2002, American Megatrends, Inc. | |

USB Configuration Screen

When you display the USB Configuration screen, the format is similar to the sample shown above. Highlight the option you wish to change and press <Enter> to display the available settings. Select the appropriate setting and press <Enter> again to accept the highlighted value.

USB CONFIGURATION OPTIONS

The descriptions for the system options listed below show the values as they appear if you have not run the BIOS Setup Utility program yet. Once values have been defined, they display each time the BIOS Setup Utility is run.

USB Function

This option allows you to enable the Universal Serial Bus (USB).

If this option is set to **Disabled**, the **Legacy USB Support**, **USB ZIP Emulation Type** and **USB Beep Message** options are not available.

The Setup screen displays the system option:

USB Function [Enabled]

Available options are:

Disabled
Enabled

Legacy USB Support

This option allows you to enable support for older USB devices.

If the **USB Function** option is set to **Disabled**, this option is not available.

The Setup screen displays the system option:

Legacy USB Support **[Auto]**

Available options are:

Disabled
Enabled
Auto

USB ZIP Emulation Type

This option allows you to set the emulation type for USB Zip drives.

If the **USB Function** option is set to **Disabled**, this option is not available.

The Setup screen displays the system option:

USB ZIP Emulation Type **[Auto]**

Available options are:

Auto
Floppy
Hard Disk

USB Beep Message

This option allows you to enable the beep during USB device enumeration.

If the **USB Function** option is set to **Disabled**, this option is not available.

The Setup screen displays the system option:

USB Beep Message **[Enabled]**

Available options are:

Disabled
Enabled

Chapter 5 PCI Plug and Play Setup

PCI PLUG AND PLAY SETUP

When you select **PCIPnP** from the BIOS Setup Utility Main Menu, the following Setup screen displays:

| BIOS SETUP UTILITY | | |
|--|----------|---|
| Main | Advanced | PCIPnP |
| | Chipset | Boot |
| | Security | Exit |
| Advanced PCI/PnP Settings | | NO: Lets the BIOS configure all the devices in the system. YES: Lets the operating system configure Plug and Play (PnP) devices not required for boot if your system has a Plug and Play operating system. |
| WARNING: Setting wrong values in below sections may cause system to malfunction. | | |
| Plug & Play O/S | | [No] |
| Reset Config Data | | [No] |
| PCI Latency Timer | | [64] |
| Allocate IRQ to PCI VGA | | [Yes] |
| Palette Snooping | | [Disabled] |
| PCI IDE BusMaster | | [Disabled] |
| Offboard PCI/ISA IDE Card | | [Auto] |
| IRQ3 | | [Available] |
| IRQ4 | | [Available] |
| IRQ5 | | [Available] |
| IRQ7 | | [Available] |
| IRQ9 | | [Available] |
| IRQ10 | | [Available] |
| IRQ11 | | [Available] |
| IRQ12 | | [Available] |
| IRQ14 | | [Available] |
| IRQ15 | | [Available] |
| DMA Channel 0 | | [Available] |
| DMA Channel 1 | | [Available] |
| DMA Channel 3 | | [Available] |
| DMA Channel 5 | | [Available] |
| DMA Channel 6 | | [Available] |
| DMA Channel 7 | | [Available] |
| Reserved Memory Size | | [Disabled] |
| Reserved Memory Address | | [C8000] |
| ←→ Select Screen ↑↓ Select Item +- Change Option F1 General Help F10 Save and Exit ESC Exit | | |
| vxx.xx (C)Copyright 1985-2002, American Megatrends, Inc. | | |

PCIPnP Setup Screen

When you display the PCIPnP Setup screen, the format is similar to the sample shown above, except the screen does not display all of the options at one time. If you need to change other options, use the down arrow key to locate the appropriate option. Highlight the option you wish to change and press <Enter> to display the available settings. Select the appropriate setting and press <Enter> again to accept the highlighted value.

NOTE: The values on the PCIPnP Setup screen do not necessarily reflect the values appropriate for your SBC. Refer to the explanations below for specific instructions about entering correct information.

PCIPnP SETUP OPTIONS

The descriptions for the system options listed below show the values as they appear if you have not yet run PCIPnP Setup. Once values have been defined, they display each time PCIPnP Setup is run.

NOTE: Do not change the values for any PCIPnP Setup option unless you understand the impact on system operation. Depending on your system configuration, selection of other values may cause unreliable system operation.

Plug & Play O/S

This option indicates whether or not the operating system installed in the computer is Plug and Play-aware. AMIBIOS only detects and enables PnP ISA adapter cards which are required for system boot. An operating system which is PnP-aware detects and enables all other PnP-aware adapter cards. Set this option to **No** if the operating system (such as DOS, OS/2, Windows 3.x) does *not* use PnP.

NOTE: You must set this option correctly or PnP-aware adapter cards installed in your computer will not be configured properly.

The Setup screen displays the system option:

| | |
|----------------------------|-------------|
| Plug & Play O/S | [No] |
|----------------------------|-------------|

Two options are available:

- Select **No** to allow AMIBIOS to configure the devices in the system.
- Select **Yes** if your system has a Plug and Play operating system and you want to allow the operating system to configure all Plug and Play (PnP) devices which are not required for bootup.

Reset Config Data

This option specifies whether the PCI/PnP configuration data which is stored in Flash will be cleared the next time the system is booted.

The Setup screen displays the system option:

| | |
|--------------------------|-------------|
| Reset Config Data | [No] |
|--------------------------|-------------|

Available options are:

No
Yes

PCI Latency Timer

This option specifies the latency of all PCI devices on the PCI Local Bus. The settings are in units equal to PCI clocks.

The Setup screen displays the system option:

| | |
|--------------------------|-------------|
| PCI Latency Timer | [64] |
| Available options are: | |
| 32 | 160 |
| 64 | 192 |
| 96 | 224 |
| 128 | 248 |

Allocate IRQ to PCI VGA

This option allows you to assign an IRQ to a PCI VGA card if the card requests an IRQ.

The Setup screen displays the system option:

| | |
|--------------------------------|--------------|
| Allocate IRQ to PCI VGA | [Yes] |
| Available options are: | |
| Yes | |
| No | |

Palette Snooping

This option, when set to **Enabled**, indicates to the PCI devices that an ISA graphics device is installed in the system so the card will function correctly.

The Setup screen displays the system option:

| | |
|-------------------------|-------------------|
| Palette Snooping | [Disabled] |
| Available options are: | |
| Disabled | |
| Enabled | |

PCI IDE BusMaster

This option specifies whether the IDE controller on the PCI Local Bus has bus mastering capability for reading and writing to IDE drives. The IDE drive(s) must support PCI bus mastering.

The Setup screen displays the system option:

PCI IDE BusMaster [Disabled]

Available options are:

Disabled
Enabled

OffBoard PCI/ISA IDE Card

This option specifies the PCI expansion slot on the SBC where the off-board PCI IDE controller is installed, if any.

The Setup screen displays the system option:

OffBoard PCI/ISA IDE Card [Auto]

Available options are:

Auto
PCI Slot1
PCI Slot2
PCI Slot3
PCI Slot4
PCI Slot5
PCI Slot6

If you select any value other than **Auto**, the following options and their default values are added to the screen:

OffBoard PCI IDE Primary IRQ/OffBoard PCI IDE Secondary

These options specify the PCI interrupts used by the primary and secondary IDE channels on the off-board PCI IDE controller. You may use the **INTA**, **INTB**, **INTC** and **INTD** options to assign IRQs to the Int Pin used by the specified channel.

If the **OffBoard PCI/ISA IDE Card** option is set to **Auto**, these options are not available.

The Setup screen displays the system options:

OffBoard PCI IDE Primary IRQ [Disabled]
OffBoard PCI IDE Secondary [Disabled]

Available options are:

Disabled
INTA
INTB
INTC
INTD
Hardwired

IRQ3/IRQ4/IRQ5/IRQ7/IRQ9/IRQ10/IRQ11/IRQ12/IRQ14/IRQ15

These options indicate whether or not the specified interrupt request (IRQ) is available for use by the system for PCI/Plug and Play devices or is reserved for use by legacy devices. This allows you to specify IRQs for use by legacy ISA adapter cards.

The IRQ setup options indicate whether AMIBIOS should remove an IRQ from the pool of available IRQs passed to BIOS configurable devices.

The Setup screen displays the system option:

IRQ# **[Available]**

where # is the number of the interrupt request (IRQ)

Two options are available:

- Select **Available** to make the specified IRQ available for use by PCI/PnP devices.
- Select **Reserved** to reserve the specified IRQ for use by legacy ISA devices.

DMA Channels 0, 1, 3, 5, 6 and 7

These options indicate whether or not the specified DMA channel is available for use by the system for PCI/Plug and Play devices or is reserved for use by legacy ISA devices.

The Setup screen displays the system option:

DMA Channel # **[Available]**

where # is the DMA Channel number

Two options are available:

- **Available** indicates that the specified DMA channel is available for use by PCI/PnP devices.
- **Reserved** indicates the specified DMA channel is reserved for use by legacy ISA devices.

Reserved Memory Size

This option specifies the size of the memory area reserved for legacy ISA devices.

If this option is set to **Disabled**, the **Reserved Memory Address** option is not available.

The Setup screen displays the system option:

Reserved Memory Size **[Disabled]**

Available options are:

Disabled
16k
32k
64k

Reserved Memory Address

This option specifies the beginning address (in hexadecimal) of the ROM memory area reserved for use by legacy ISA adapter cards.

If the **Reserved Memory Size** option is set to **Disabled**, this option is not available.

The Setup screen displays the system option:

Reserved Memory Address **[C8000]**

Available options are:

C0000 D0000
C4000 D4000
C8000 D8000
CC000 DC000

Saving and Exiting

When you have made all desired changes to PCIPnP Setup, you may make changes to other Setup options by using the right and left arrow keys to access other menus. When you have made all of your changes, you may save them by selecting the Exit menu, or you may press <Esc> at any time to exit the BIOS Setup Utility without saving the changes.

Chapter 6 Chipset Setup

CHIPSET SETUP

When you select **Chipset** from the BIOS Setup Utility Main Menu, the following Setup screen displays:

| BIOS SETUP UTILITY | | | | | | |
|---|----------|--------|---------|--|----------|------|
| Main | Advanced | PCIPnP | Chipset | Boot | Security | Exit |
| > Intel Brookdale-G NorthBridge Configuration > Intel ICH4 SouthBridge Configuration | | | | Intel Brookdale-G NorthBridge chipset configuration options. | | |
| | | | | ←→ Select Screen ↑↓ Select Item Enter Go to Sub Screen F1 General Help F10 Save and Exit ESC Exit | | |
| vxx.xx (C)Copyright 1985-2002, American Megatrends, Inc. | | | | | | |

Chipset Setup Screen

When you display the Chipset Setup screen, the format is similar to the sample shown above, allowing you to continue to subscreens designed to change parameters for each of the Chipset Setup options. Highlight the option you wish to change and press <Enter> to proceed to the appropriate subscreen.

NOTE: The values on the Chipset Setup subscreen do not necessarily reflect the values appropriate for your SBC. Refer to the explanations following the screen for specific instructions about entering correct information.

CHIPSET SETUP OPTIONS

NOTE: Do not change the values for any Chipset Setup option unless you understand the impact on system operation. Depending on your system configuration, selection of other values may cause unreliable system operation.

Intel Brookdale-G NorthBridge Configuration

The options on the **ICH4 Brookdale-G NorthBridge Configuration** subscreen allow you to set up or modify parameters to configure the Intel ICH4 Brookdale-G NorthBridge chip. The following options may be modified:

- Primary Video Device
- Graphics Mode Select
- Graphics Aperture Size
- Search for MDA Resources

Intel ICH4 SouthBridge Configuration

The options on the **ICH4 SouthBridge Configuration** subscreen allow you to set up or modify parameters to configure the Intel ICH4 SouthBridge chip. The following options may be modified:

- ICH4 Dev31 Func1, IDE
- ICH4 Dev31 Func3, SMBUS
- ICH4 Dev29 Func0, USB#1
- ICH4 Dev29 Func7, EHCI
- LPC 4Eh-4Fh Decode
- LPC 2Eh-2Fh Decode
- On board Lan
- ISA Bus
- IOAPIC
- Extended IOAPIC
- CPU B.I.S.T.
- ICH4 DMA Collection
- PC/PCIB Select
- DMA Types 0 through 7

Saving and Exiting

When you have made all desired changes to **Chipset Setup**, you may make changes to other Setup options by using the right and left arrow keys to access other menus. When you have made all of your changes, you may save them by selecting the **Exit** menu, or you may press <Esc> at any time to exit the BIOS Setup Utility without saving the changes.

**INTEL
BROOKDALEG
NORTHBRIDGE
CONFIGURATION**

When you select **Intel Brookdale-G NorthBridge Configuration** from the Chipset Setup Screen, the following Setup screen displays:

| BIOS SETUP UTILITY | |
|--|--|
| Main | Advanced PCI/PnP Chipset Boot Security Exit |
| Configure advanced settings for NorthBridge | Select which graphics controller to use as the primary boot device. |
| Primary Video Device | [Auto] |
| Graphics Mode Select | [Enabled, 8MB] |
| Graphics Aperture Size | [64MB] |
| Search for MDA Resources | [Yes] |
| | ←→ Select Screen ↑↓ Select Item +- Change Option F1 General Help F10 Save and Exit ESC Exit |
| vxx.xx (C)Copyright 1985-2002, American Megatrends, Inc. | |

Intel Brookdale-G NorthBridge Configuration Screen

When you display the Intel Brookdale-G NorthBridge Configuration screen, the format is similar to the sample shown above. Highlight the option you wish to change and press <Enter> to display the available settings. Select the appropriate setting and press <Enter> again to accept the highlighted value.

**INTEL
BROOKDALEG
NORTHBRIDGE
CONFIGURATION
OPTIONS**

The descriptions for the system options listed below show the values as they appear if you have not yet run Chipset Setup. Once values have been defined, they display each time Chipset Setup is run.

Primary Video Device

This option allows you to select the graphics controller you want to use as the primary boot device.

The Setup screen displays the system option:

Primary Video Device [Auto]

Available options are:

- Internal
- External PCI
- External AGP
- Auto

Graphics Mode Select

This option allows you to specify the amount of system memory used by the internal graphics device.

The Setup screen displays the system option:

Graphics Mode Select **[Enabled, 8MB]**

Available options are:

- Enabled, 1MB
- Enabled, 8MB

Graphics Aperture Size

This option allows you to set the size of the AGP aperture.

The Setup screen displays the system option:

Graphics Aperture Size **[_64MB]**

Available options are:

- 4MB
- 8MB
- 16MB
- 32MB
- 64MB
- 128MB
- 256MB

Search for MDA Resources

This option allows you to search for and set up an MDA (monochrome) video adapter.

The Setup screen displays the system option:

Search for MDA Resources **[Yes]**

Available options are:

- No
- Yes

**INTEL ICH4
SOUTHBRIDGE
CONFIGURATION**

When you select **Intel ICH4 SouthBridge Configuration** from the Chipset Setup Screen, the following Setup screen displays:

| BIOS SETUP UTILITY | | | | | | | | | | | | | | | | | | | | | | | | | | | | | | | | | | | | | | | | | | | | | | | | | |
|---|--|--|--|-----------------------|-----------|-------------------------|-----------|-------------------------|-----------|------------------------|------------|--|--|--------------------|-----------|--------------------|-----------|--|--|-------------|-----------|---------|-----------|--------|-----------|-----------------|-----------|--------------|-----------|---------------------|-----------|----------------|------------|--|--|------------|----------|------------|----------|------------|-----------|------------|----------|------------|----------|------------|----------|------------|----------|
| Main | Advanced Chipset | | | | | | | | | | | | | | | | | | | | | | | | | | | | | | | | | | | | | | | | | | | | | | | | |
| Configure advanced settings for SouthBridge <table border="0" style="width: 100%;"> <tr> <td style="width: 60%;"></td> <td style="text-align: right;">Enable / Disable ICH4 IDE Controller function.</td> </tr> <tr> <td>ICH4 Dev31 Func1, IDE</td> <td style="text-align: right;">[Enabled]</td> </tr> <tr> <td>ICH4 Dev31 Func3, SMBUS</td> <td style="text-align: right;">[Enabled]</td> </tr> <tr> <td>ICH4 Dev29 Func0, USB#1</td> <td style="text-align: right;">[Enabled]</td> </tr> <tr> <td>ICH4 Dev29 Func7, EHCI</td> <td style="text-align: right;">[Disabled]</td> </tr> <tr> <td colspan="2"> </td> </tr> <tr> <td>LPC 4Eh-4Fh Decode</td> <td style="text-align: right;">[Enabled]</td> </tr> <tr> <td>LPC 2Eh-2Fh Decode</td> <td style="text-align: right;">[Enabled]</td> </tr> <tr> <td colspan="2"> </td> </tr> <tr> <td>Onboard Lan</td> <td style="text-align: right;">[Enabled]</td> </tr> <tr> <td>ISA BUS</td> <td style="text-align: right;">[Enabled]</td> </tr> <tr> <td>IOAPIC</td> <td style="text-align: right;">[Enabled]</td> </tr> <tr> <td>Extended IOAPIC</td> <td style="text-align: right;">[Enabled]</td> </tr> <tr> <td>CPU B.I.S.T.</td> <td style="text-align: right;">[Enabled]</td> </tr> <tr> <td>ICH4 DMA Collection</td> <td style="text-align: right;">[Enabled]</td> </tr> <tr> <td>PC/PCIB Select</td> <td style="text-align: right;">[Disabled]</td> </tr> <tr> <td colspan="2"> </td> </tr> <tr> <td>DMA-0 Type</td> <td style="text-align: right;">[PC/PCI]</td> </tr> <tr> <td>DMA-1 Type</td> <td style="text-align: right;">[PC/PCI]</td> </tr> <tr> <td>DMA-2 Type</td> <td style="text-align: right;">[LPC DMA]</td> </tr> <tr> <td>DMA-3 Type</td> <td style="text-align: right;">[PC/PCI]</td> </tr> <tr> <td>DMA-5 Type</td> <td style="text-align: right;">[PC/PCI]</td> </tr> <tr> <td>DMA-6 Type</td> <td style="text-align: right;">[PC/PCI]</td> </tr> <tr> <td>DMA-7 Type</td> <td style="text-align: right;">[PC/PCI]</td> </tr> </table> | | | Enable / Disable ICH4 IDE Controller function. | ICH4 Dev31 Func1, IDE | [Enabled] | ICH4 Dev31 Func3, SMBUS | [Enabled] | ICH4 Dev29 Func0, USB#1 | [Enabled] | ICH4 Dev29 Func7, EHCI | [Disabled] | | | LPC 4Eh-4Fh Decode | [Enabled] | LPC 2Eh-2Fh Decode | [Enabled] | | | Onboard Lan | [Enabled] | ISA BUS | [Enabled] | IOAPIC | [Enabled] | Extended IOAPIC | [Enabled] | CPU B.I.S.T. | [Enabled] | ICH4 DMA Collection | [Enabled] | PC/PCIB Select | [Disabled] | | | DMA-0 Type | [PC/PCI] | DMA-1 Type | [PC/PCI] | DMA-2 Type | [LPC DMA] | DMA-3 Type | [PC/PCI] | DMA-5 Type | [PC/PCI] | DMA-6 Type | [PC/PCI] | DMA-7 Type | [PC/PCI] |
| | Enable / Disable ICH4 IDE Controller function. | | | | | | | | | | | | | | | | | | | | | | | | | | | | | | | | | | | | | | | | | | | | | | | | |
| ICH4 Dev31 Func1, IDE | [Enabled] | | | | | | | | | | | | | | | | | | | | | | | | | | | | | | | | | | | | | | | | | | | | | | | | |
| ICH4 Dev31 Func3, SMBUS | [Enabled] | | | | | | | | | | | | | | | | | | | | | | | | | | | | | | | | | | | | | | | | | | | | | | | | |
| ICH4 Dev29 Func0, USB#1 | [Enabled] | | | | | | | | | | | | | | | | | | | | | | | | | | | | | | | | | | | | | | | | | | | | | | | | |
| ICH4 Dev29 Func7, EHCI | [Disabled] | | | | | | | | | | | | | | | | | | | | | | | | | | | | | | | | | | | | | | | | | | | | | | | | |
| | | | | | | | | | | | | | | | | | | | | | | | | | | | | | | | | | | | | | | | | | | | | | | | | | |
| LPC 4Eh-4Fh Decode | [Enabled] | | | | | | | | | | | | | | | | | | | | | | | | | | | | | | | | | | | | | | | | | | | | | | | | |
| LPC 2Eh-2Fh Decode | [Enabled] | | | | | | | | | | | | | | | | | | | | | | | | | | | | | | | | | | | | | | | | | | | | | | | | |
| | | | | | | | | | | | | | | | | | | | | | | | | | | | | | | | | | | | | | | | | | | | | | | | | | |
| Onboard Lan | [Enabled] | | | | | | | | | | | | | | | | | | | | | | | | | | | | | | | | | | | | | | | | | | | | | | | | |
| ISA BUS | [Enabled] | | | | | | | | | | | | | | | | | | | | | | | | | | | | | | | | | | | | | | | | | | | | | | | | |
| IOAPIC | [Enabled] | | | | | | | | | | | | | | | | | | | | | | | | | | | | | | | | | | | | | | | | | | | | | | | | |
| Extended IOAPIC | [Enabled] | | | | | | | | | | | | | | | | | | | | | | | | | | | | | | | | | | | | | | | | | | | | | | | | |
| CPU B.I.S.T. | [Enabled] | | | | | | | | | | | | | | | | | | | | | | | | | | | | | | | | | | | | | | | | | | | | | | | | |
| ICH4 DMA Collection | [Enabled] | | | | | | | | | | | | | | | | | | | | | | | | | | | | | | | | | | | | | | | | | | | | | | | | |
| PC/PCIB Select | [Disabled] | | | | | | | | | | | | | | | | | | | | | | | | | | | | | | | | | | | | | | | | | | | | | | | | |
| | | | | | | | | | | | | | | | | | | | | | | | | | | | | | | | | | | | | | | | | | | | | | | | | | |
| DMA-0 Type | [PC/PCI] | | | | | | | | | | | | | | | | | | | | | | | | | | | | | | | | | | | | | | | | | | | | | | | | |
| DMA-1 Type | [PC/PCI] | | | | | | | | | | | | | | | | | | | | | | | | | | | | | | | | | | | | | | | | | | | | | | | | |
| DMA-2 Type | [LPC DMA] | | | | | | | | | | | | | | | | | | | | | | | | | | | | | | | | | | | | | | | | | | | | | | | | |
| DMA-3 Type | [PC/PCI] | | | | | | | | | | | | | | | | | | | | | | | | | | | | | | | | | | | | | | | | | | | | | | | | |
| DMA-5 Type | [PC/PCI] | | | | | | | | | | | | | | | | | | | | | | | | | | | | | | | | | | | | | | | | | | | | | | | | |
| DMA-6 Type | [PC/PCI] | | | | | | | | | | | | | | | | | | | | | | | | | | | | | | | | | | | | | | | | | | | | | | | | |
| DMA-7 Type | [PC/PCI] | | | | | | | | | | | | | | | | | | | | | | | | | | | | | | | | | | | | | | | | | | | | | | | | |
| ←→ Select Screen ↑↓ Select Item +- Change Option F1 General Help F10 Save and Exit ESC Exit | | | | | | | | | | | | | | | | | | | | | | | | | | | | | | | | | | | | | | | | | | | | | | | | | |
| vxx.xx (C)Copyright 1985-2002, American Megatrends, Inc. | | | | | | | | | | | | | | | | | | | | | | | | | | | | | | | | | | | | | | | | | | | | | | | | | |

Intel ICH4 SouthBridge Configuration Screen

When you display the Intel ICH4 SouthBridge Configuration screen, the format is similar to the sample shown above, except the screen does not display all of the options at one time. If you need to change other options, use the down arrow key to locate the appropriate option. Highlight the option you wish to change and press **<Enter>** to display the available settings. Select the appropriate setting and press **<Enter>** again to accept the highlighted value.

**INTEL ICH4
SOUTHBRIDGE
CONFIGURATION
OPTIONS**

The descriptions for the system options listed below show the values as they appear if you have not yet run Chipset Setup. Once values have been defined, they display each time Chipset Setup is run.

ICH4 Dev31 Func1, IDE

This option allows you to enable or disable ICH4 IDE Controller function.

The Setup screen displays the system option:

ICH4 Dev31 Func1, IDE **[Enabled]**

Available options are:

Disabled
Enabled

ICH4 Dev31 Func3, SMBUS

This option allows you to enable or disable ICH3 SMBUS Controller function.

The Setup screen displays the system option:

ICH4 Dev31 Func3, SMBUS **[Enabled]**

Available options are:

Disabled
Enabled

ICH4 Dev29 Func0, USB#1

This option allows you to enable or disable USB Host Controller #1 function.

The Setup screen displays the system option:

ICH4 Dev29 Func0, USB#1 **[Enabled]**

Available options are:

Disabled
Enabled

ICH4 Dev29 Func7, EHCI

This option allows you to enable or disable EHCI USB Controller function. Be sure that the **ICH4 Dev29 Func0, USB#1** option is set to **Enabled** before enabling this option.

The Setup screen displays the system option:

ICH4 Dev29 Func7, EHCI **[Disabled]**

Available options are:

Disabled
Enabled

LPC 4Eh-4Fh Decode/LPC 2Eh-2Fh Decode

The **LPC 4Eh-4Fh Decode** option allows you to enable or disable decoding of I/O locations 4Eh and 4Fh to the LPC interface. The **LPC 2Eh-2Fh Decode** option cannot be modified.

The Setup screen displays the system options:

| | |
|---------------------------|------------------|
| LPC 4Eh-4Fh Decode | [Enabled] |
| LPC 2Eh-2Fh Decode | [Enabled] |

Available options are:

Disabled
Enabled

On Board Lan

This option specifies whether or not the first on-board Ethernet controller (LAN 1/P16) is to be used. The LAN 1 interface supports 10/100Base-T operations.

The Setup screen displays the system option:

| | |
|---------------------|------------------|
| On board Lan | [Enabled] |
|---------------------|------------------|

Available options are:

Disabled
Enabled

ISA BUS

This option allows you to enable or disable the PCI/ISA on-board bridge.

If this option is set to **Enabled**, the **ICH4 Positive Decode** option is not available.

The Setup screen displays the system option:

| | |
|----------------|------------------|
| ISA BUS | [Enabled] |
|----------------|------------------|

Available options are:

Disabled
Enabled

ICH4 Positive Decode

This option allows you to enable or disable positive decode in ICH4. Set this option to **Enabled** if the on-board PCI/ISA bridge is present.

If the **ISA BUS** option is set to **Enabled**, this option is not available.

The Setup screen displays the system option:

ICH4 Positive Decode **[Enabled]**

Available options are:

Disabled
Enabled

IOAPIC

This option allows you to enable or disable the ICH4 IOAPIC function.

The Setup screen displays the system option:

IOAPIC **[Enabled]**

Available options are:

Disabled
Enabled

Extended IOAPIC

This option allows you to enable or disable the extended mode of the ICH4 IOAPIC function.

The Setup screen displays the system option:

Extended IOAPIC **[Enabled]**

Available options are:

Disabled
Enabled

CPU B.I.S.T.

This option allows you to enable or disable the CPU Built-In Self Test.

The Setup screen displays the system option:

CPU B.I.S.T. **[Enabled]**

Available options are:

Disabled
Enabled

ICH4 DMA Collection

This option allows you to enable or disable the DMA collection buffer.

The Setup screen displays the system option:

ICH4 DMA Collection **[Enabled]**

Available options are:

Disabled
Enabled

PC/PCIB Select

The Setup screen displays the system option:

PC/PCIB Select **[Disabled]**

Available options are:

Disabled
Enabled

DMA Types 0, 1, 2, 3, 5, 6 and 7

This option allows you to select the type of DMA performed on the specified channel.

The Setup screen displays the system option:

DMA-# Type **[PC/PCI]**

where # is the DMA number

Available options are:

PC/PCI
LPC DMA

This page intentionally left blank.

Chapter 7 *Boot Setup*

BOOT SETUP

When you select **Boot** from the BIOS Setup Utility Main Menu, the following Setup screen displays:

| BIOS SETUP UTILITY | |
|---|--|
| Main | Advanced PCIPnP Chipset Boot Security Exit |
| <p>Advanced Boot Settings</p> <hr/> <p>> Boot Settings Configuration</p> <p>> Boot Device Priority</p> <p>> Hard Disk Drives</p> <p>> Removable Devices</p> <p>> ATAPI CDROM Drives</p> <p>Interrupt 19 Capture [Disabled]</p> | <p>Configure Settings during System Boot.</p> <p>←→ Select Screen</p> <p>↑↓ Select Item</p> <p>Enter Go to Sub Screen</p> <p>F1 General Help</p> <p>F10 Save and Exit</p> <p>ESC Exit</p> |
| vxx.xx (C)Copyright 1985-2002, American Megatrends, Inc. | |

Boot Setup Screen

When you display the Boot Setup screen, the format is similar to the sample shown above. Highlight the option you wish to change and press <Enter> to display the available settings. Select the appropriate setting and press <Enter> again to accept the highlighted value.

Some of the options on this screen allow you to continue to subscreens designed to change parameters for that particular option. Highlight the option you wish to change and press <Enter> to proceed to the appropriate subscreen.

NOTE: If no device is found for one of the device types, the line item for that device type does not display.

BOOT SETUP OPTIONS

The descriptions for the system option listed below show the values as they appear if you have not yet run Boot Setup. Once values have been changed, they display each time Boot Setup is run. You may also continue to subscreens to specify boot parameters and the boot sequence of bootable devices in your system.

Boot Settings Configuration

The options on the **Boot Settings Configuration** subscreen allow you to set up or modify parameters for boot procedures. The following options may be modified:

- Quick Boot
- Quiet Boot
- AddOn ROM Display Mode
- Bootup Num-Lock
- PS/2 Mouse Support
- System Keyboard
- Boot To OS/2
- Wait For 'F1' If Error
- Hit 'DEL' Message Display

Boot Device Priority

The options on the **Boot Device Priority** subscreen specify the order in which AMIBIOS attempts to boot devices available in the system. It allows you to select the type of drive which will be booted first, second, third, etc. If there are multiple drives of a particular type, you may specify the order in which each drive of that type will be selected by using the other options on the Boot Setup Menu.

Hard Disk Drives

The **Hard Disk Drives** subscreen specifies the boot sequence of the hard drives available in the system.

Removable Devices

The **Removable Devices** subscreen specifies the boot sequence of the removable devices available in the system.

ATAPI CDROM Drives

The **ATAPI CDROM Drives** subscreen specifies the boot sequence of the ATAPI CDROM devices available in the system.

Interrupt 19 Capture

The Setup screen displays the system option:

Interrupt 19 Capture **[Disabled]**

Available options are:

Disabled
Enabled

Saving and Exiting

When you have made all desired changes to **Boot Setup**, you may make changes to other Setup options by using the right and left arrow keys to access other menus. When you have made all of your changes, you may save them by selecting the **Exit** menu, or you may press <Esc> at any time to exit the BIOS Setup Utility without saving the changes.

This page intentionally left blank.

BOOT SETTINGS CONFIGURATION

When you select **Boot Settings Configuration** from the Boot Setup Menu, the following Setup screen displays:

| BIOS SETUP UTILITY | |
|--|---|
| Boot | |
| Boot Settings Configuration <hr/> Quick Boot [Disabled] Quiet Boot [Disabled] AddOn ROM Display Mode [Force BIOS] <hr/> Bootup Num-Lock [On] PS/2 Mouse Support [Enabled] System Keyboard [Present] Boot To OS/2 [No] Wait For 'F1' If Error [Enabled] Hit 'DEL' Message Display [Enabled] | Allows BIOS to skip certain tests while booting. This will decrease the time needed to boot the system. ←→ Select Screen ↑↓ Select Item +- Change Option F1 General Help F10 Save and Exit ESC Exit |
| vxx.xx (C)Copyright 1985-2002, American Megatrends, Inc. | |

Boot Settings Configuration Screen

When you display the Boot Settings Configuration screen, the format is similar to the sample shown above. Highlight the option you wish to change and press <Enter> to display the available settings. Select the appropriate setting and press <Enter> again to accept the highlighted value.

BOOT SETTINGS CONFIGURATION OPTIONS

The descriptions for the system options listed below show the values as they appear if you have not run the BIOS Setup Utility program yet. Once values have been defined, they display each time the BIOS Setup Utility is run.

Quick Boot

This option allows you to have the AMIBIOS boot quickly when the computer is powered on or go through more complete testing. If you set the **Quick Boot** option to **Enabled**, the BIOS skips certain tests while booting and decreases the time needed to boot the system.

The Setup screen displays the system option:

Quick Boot [Disabled]

PS/2 Mouse Support

This option indicates whether or not a PS/2-type mouse is supported.

The Setup screen displays the system option:

PS/2 Mouse Support **[Enabled]**

Available options are:

Disabled
Enabled

System Keyboard

This option indicates whether or not a keyboard is attached to the computer.

The Setup screen displays the system option:

System Keyboard **[Present]**

Available options are:

Absent
Present

Boot To OS/2

This option should be set to **Yes** if you are running the IBM OS/2 operating system and using more than 64MB of system memory on the SBC.

The Setup screen displays the system option:

Boot To OS/2 **[No]**

Available options are:

No
Yes

Wait For 'F1' If Error

Before the system boots up, the AMIBIOS executes the Power-On Self Test (POST) routines, a series of system diagnostic routines. If any of these tests fail but the system can still function, a non-fatal error has occurred. The AMIBIOS responds with an appropriate error message followed by:

Press F1 to RESUME

If this option is set to **Disabled**, a non-fatal error does not generate the "Press F1 to RESUME" message. The AMIBIOS still displays the appropriate message, but continues the booting process without waiting for the <F1> key to be pressed. This eliminates the need for any user response to a non-fatal error condition message. Non-fatal error messages are listed in *Appendix A - BIOS Messages*.

The Setup screen displays the system option:

Wait For 'F1' If Error **[Enabled]**

Available options are:

Disabled
Enabled

Hit 'DEL' Message Display

The "Hit DEL to run Setup" message displays when the system boots up. Disabling this option prevents the message from displaying.

The Setup screen displays the system option:

Hit 'DEL' Message Display **[Enabled]**

Available options are:

Disabled
Enabled

BOOT DEVICE PRIORITY

When you select **Boot Device Priority** from the Boot Setup Menu, the following Setup screen displays:

| BIOS SETUP UTILITY | |
|--|--|
| Boot | |
| <p>Boot Device Priority</p> <hr/> <p>1st Boot Device [xxxxxxxxx] 2nd Boot Device [xxxxxxxxx] 3rd Boot Device [xxxxxxxxx]</p> | <p>Specifies the boot sequence from the available devices.</p> <p>A device enclosed in parentheses has been disabled in the corresponding type menu.</p> <p>←→ Select Screen ↑↓ Select Item +- Change Option F1 General Help F10 Save and Exit ESC Exit</p> |
| vxx.xx (C)Copyright 1985-2002, American Megatrends, Inc. | |

Boot Device Priority Screen

When you display the Boot Device Priority screen, the format is similar to the sample shown above. Highlight the option you wish to change and press <Enter> to display the available settings. Select the appropriate setting and press <Enter> again to accept the highlighted value.

NOTE: The number of line items on this screen may vary depending on the number of bootable devices available on your system.

BOOT DEVICE PRIORITY OPTIONS

1st Boot Device/2nd Boot Device/3rd Boot Device

This option specifies the device type/description of each boot drive from which AMIBIOS attempts to boot after the POST routines complete.

The Setup screen displays the system option(s):

1st Boot Device [xxxxxxxxx]
2nd Boot Device [xxxxxxxxx]
3rd Boot Device [xxxxxxxxx]

Available options for each boot device line item are determined by the bootable devices available on your system.

This page intentionally left blank.

Disabled is also available as an option if you do not want a particular drive to be included in the boot sequence.

The Setup screen displays the system options:

| | |
|-----------|------------|
| 1st Drive | [xxxxxxxx] |
| 2nd Drive | [xxxxxxxx] |
| 3rd Drive | [xxxxxxxx] |

where xxxxxxxx is the description of the hard drive

REMOVABLE DRIVES

When you select **Removable Drives** from the Boot Setup Menu, the following Setup screen displays:

| | |
|---|--|
| BIOS SETUP UTILITY | |
| Boot | |
| <p>Removable Drives</p> <hr/> <p>1st Drive [xxxxxxxx]</p> <p>2nd Drive [xxxxxxxx]</p> | <p>Specifies the boot sequence from the available devices.</p> <p>←→ Select Screen</p> <p>↑↓ Select Item</p> <p>+ - Change Option</p> <p>F1 General Help</p> <p>F10 Save and Exit</p> <p>ESC Exit</p> |
| vxx.xx (C)Copyright 1985-2002, American Megatrends, Inc. | |

Removable Devices Screen

When you display the Removable Drives screen, the format is similar to the sample shown above. Highlight the option you wish to change and press <Enter> to display the available settings. Select the appropriate setting and press <Enter> again to accept the highlighted value.

NOTE: This screen is available only if there is at least one removable device on your system. The number of line items is determined by the number of removable devices available.

REMOVABLE DRIVES OPTIONS

The SBC supports multiple removable devices and allows you to change the boot sequence of these devices.

1st Drive/2nd Drive

When the system boots up, it searches for all removable drives and displays the description of each device it has detected.

If you have more than one removable drive, you may change the order in which the system will attempt to boot the available devices by changing these line items. The number of options displayed for each line item depends on the number of removable devices in your system.

Disabled is also available as an option if you do not want a particular device to be included in the boot sequence.

The Setup screen displays the system option:

| | |
|------------------|------------|
| 1st Drive | [xxxxxxxx] |
| 2nd Drive | [xxxxxxxx] |

where xxxxxxxx is the description of the removable device (e.g., floppy drive, IOMEGA ZIP drive, etc.)

ATAPI CDROM DRIVES

When you select **ATAPI CDROM Drives** from the Boot Setup Menu, the following Setup screen displays:

| | | |
|--|--------------------------|--|
| BIOS SETUP UTILITY | | |
| Boot | | |
| 1st Drive 2nd Drive | [xxxxxxxx] [xxxxxxxx] | Specifies the boot sequence from the available devices. |
| | | ←→ Select Screen ↑↓ Select Item +- Change Option F1 General Help F10 Save and Exit ESC Exit |
| vxx.xx (C)Copyright 1985-2002, American Megatrends, Inc. | | |

ATAPI CDROM Drives Screen

When you display the ATAPI CDROM Drives screen, the format is similar to the sample shown above. Highlight the option you wish to change and press <Enter> to display the available settings. Select the appropriate setting and press <Enter> again to accept the highlighted value.

NOTE: This screen is available only if there is at least one ATAPI CDROM drive on your system. The number of line items is determined by the number of ATAPI CDROM drives available.

ATAPI CDROM DRIVES OPTIONS

The SBC supports multiple ATAPI CD-ROM devices and allows you to change the boot sequence of these devices.

1st Drive/2nd Drive

When the system boots up, it searches for all ATAPI CD-ROM drives and displays the description of each drive it has detected.

If you have more than one ATAPI CD-ROM drive, you may change the order in which the system will attempt to boot the available drives by changing these line items. The number of options displayed for each line item depends on the number of ATAPI CD-ROM devices in your system.

Disabled is also available as an option if you do not want a particular drive to be included in the boot sequence.

The Setup screen displays the system option:

| | |
|------------------|------------|
| 1st Drive | [xxxxxxxx] |
| 2nd Drive | [xxxxxxxx] |

where xxxxxxxx is the description of the ATAPI CD-ROM drive

Appendix A BIOS Messages

BIOS BEEP CODES Errors may occur during the POST (Power-On Self Test) routines which are performed each time the system is powered on.

Non-fatal errors are those which, in most cases, allow the system to continue the bootup process. The error message normally appears on the screen. See *BIOS Error Messages* later in this section for descriptions of these messages.

Fatal errors are those which will not allow the system to continue the bootup procedure.

These fatal errors are usually communicated through a series of audible beeps. Each error message has its own specific beep code, defined by the number of beeps following the error detection. The following table lists the errors which are communicated audibly.

| Beep Count | Description |
|------------|---|
| 1 | Memory refresh timer error |
| 2 | Parity Error |
| 3 | Main memory read/write test error |
| 4 | Timer not operational |
| 5 | Processor error |
| 6 | Keyboard controller BAT test error |
| 7 | General exception error |
| 8 | Display memory error |
| 9 | ROM checksum error |
| 10 | CMOS shutdown register read/write error |
| 11 | Cache memory bad |

BIOS BEEP CODE TROUBLESHOOTING

| Beep Count | Troubleshooting Action |
|------------|---|
| 1, 2 or 3 | Reseat the memory or replace with known good modules. |
| 4-7, 9-11 | Fatal error. Perform the following steps before calling Technical Support. Remove all expansion cards and and try to reboot. If the beep code is still generated, call Technical Support. If the beep code is not generated, one of the add-in cards is causing the malfunction. Insert the cards back into the system one at a time until the problem recurs. This will indicate the malfunctioning card. |
| 8 | The board may be faulty. Call Technical Support. |

BIOS ERROR MESSAGES

If a non-fatal error occurs during the POST routines performed each time the system is powered on, the error message will appear on the screen in the following format:

ERROR Message Line 1
 ERROR Message Line 2
 Press F1 to Resume

Note the error message and press the <F1> key to continue with the bootstrap procedure.

NOTE: If the "Wait for 'F1' If Any Error" option in the Advanced Setup portion of the BIOS Setup Program has been set to **Disabled**, the "Press F1 to Resume" prompt will not appear on the last line.

For most of the error messages, there is no ERROR Message Line 2. Generally, for those messages containing an ERROR Message Line 2, the text will be "RUN SETUP UTILITY." Pressing the <F1> key will invoke the BIOS Setup Utility.

A description of each error message appears below.

MEMORY ERRORS

| Message | Description |
|---------------------|--|
| Gate20 Error | The BIOS is unable to properly control the SBC's Gate A20 function, which controls access to memory over 1MB. This may indicate a problem with the board. |
| Multi-Bit ECC Error | This message only occurs on systems using ECC enabled memory modules. ECC memory has the ability to correct single-bit errors that may occur from faulty memory modules. A multiple bit corruption of memory has occurred, and the ECC memory algorithm cannot correct it. This may indicate a defective memory module. |
| Parity Error | Fatal memory parity error. System halts after displaying this message. |

BOOT ERRORS

| Message | Description |
|-----------------------|---|
| Boot Failure ... | This is a generic message indicating the BIOS could not boot from a particular device. This message is usually followed by other information concerning the device. |
| Invalid Boot Diskette | A diskette was found in the drive, but it is not configured as a bootable diskette. |
| Drive Not Ready | The BIOS was unable to access the drive because it indicated it was not ready for data transfer. This is often reported by drives when no media is present. |

BIOS ERROR MESSAGES (CONTINUED)

BOOT ERRORS (continued)

| Message | Description |
|---|---|
| A: Drive Error | The BIOS attempted to configure the A: drive during POST, but was unable to properly configure the device. This may be due to a bad cable or faulty diskette drive. |
| B: Drive Error | The BIOS attempted to configure the B: drive during POST, but was unable to properly configure the device. This may be due to a bad cable or faulty diskette drive. |
| Insert BOOT diskette in A: | The BIOS attempted to boot from the A: drive, but could not find a proper boot diskette. |
| Reboot and Select proper Boot device or Insert Boot Media in selected Boot device | BIOS could not find a bootable device in the system and/or removable media drive does not contain media. |
| NO ROM BASIC | This message occurs on some systems when no bootable device can be detected. |

STORAGE DEVICE ERRORS

| Message | Description |
|---|---|
| The following errors are typically displayed when the BIOS is trying to detect and configure IDE/ATAPI devices in POST. | |
| XXXXXX Hard Disk Error XXXXXX - ATAPI Incompatible | Messages in this format indicate that the specified device could not be properly initialized by the BIOS. Possible message are: Primary Master Hard Disk Error Primary Slave Hard Disk Error Secondary Master Hard Disk Error Secondary Slave Hard Disk Error Primary Master Drive - ATAPI Incompatible Primary Slave Drive - ATAPI Incompatible Secondary Master Drive - ATAPI Incompatible Secondary Slave Drive - ATAPI Incompatible |
| The following messages can be reported by an ATAPI device using the S.M.A.R.T. error reporting standard. The S.M.A.R.T. failure message may indicate the need to replace the hard disk. | |
| S.M.A.R.T. Capable but Command Failed | The BIOS tried to send a S.M.A.R.T. message to a hard disk, but the command transaction failed. |
| S.M.A.R.T. Command Failed | The BIOS tried to send a S.M.A.R.T. message to a hard disk, but the command transaction failed. |
| S.M.A.R.T. Status BAD, Backup and Replace | A S.M.A.R.T. capable hard disk sends this message when it detects an imminent failure. |
| S.M.A.R.T. Capable and Status BAD | A S.M.A.R.T. capable hard disk sends this message when it detects an imminent failure. |

**BIOS ERROR
MESSAGES
(CONTINUED)**

VIRUS RELATED ERRORS

| Message | Description |
|--|--|
| The following messages only display if Virus Detection is enabled in the BIOS Setup Utility. | |
| BootSector Write !! | The BIOS has detected software attempting to write to a drive's boot sector. This is flagged as possible virus activity. |
| VIRUS: Continue (Y/N)? | The BIOS has detected possible virus activity. |

SYSTEM CONFIGURATION ERRORS

| Message | Description |
|-----------------------------------|---|
| DMA-2 Error | Error initializing secondary DMA controller. This is a fatal error, often indicating a problem with system hardware. |
| DMA Controller Error | POST error while trying to initialize the DMA controller. This is a fatal error, often indicating a problem with system hardware. |
| Checking NVRAM..Update Failed | BIOS could not write to the NVRAM block. This message appears when the FLASH part is write-protected or if there is no FLASH part (system uses a PROM or EPROM). |
| Microcode Error | BIOS could not find or load the CPU Microcode Update to the CPU. This message only applies to INTEL CPUs. The message is most likely to appear when a brand new CPU is installed in an SBC with an outdated BIOS. In this case, the BIOS must be updated to include the Microcode Update for the new CPU. |
| NVRAM Checksum Bad, NVRAM Cleared | There was an error while validating the NVRAM data. This causes POST to clear the NVRAM data. |
| Resource Conflict | More than one system device is trying to use the same non-shareable resources (memory or I/O). |
| NVRAM Ignored | The NVRAM data used to store Plug and Play (PnP) data was not used for system configuration in POST. |
| NVRAM Bad | The NVRAM data used to store Plug and Play (PnP) data was not used for system configuration in POST due to a data error. |
| Static Resource Conflict | Two or more static devices are trying to use the same resource space (usually memory or I/O). |
| PCI I/O Conflict | A PCI adapter generated an I/O resource conflict when configured by BIOS POST. |
| PCI ROM Conflict | A PCI adapter generated an I/O resource conflict when configured by BIOS POST. |
| PCI IRQ Conflict | A PCI adapter generated an I/O resource conflict when configured by BIOS POST. |
| PCI IRQ Routing Table Error | BIOS POST (DIM code) found a PCI device in the system but was unable to figure out how to route an IRQ to the device. Usually this error is caused by an incomplete description of the PCI Interrupt Routine of the system. |

**BIOS ERROR
MESSAGES
(CONTINUED)****SYSTEM CONFIGURATION ERRORS (continued)**

| Message | Description |
|------------------------------|---|
| Timer Error | Indicates an error while programming the count register of channel 2 of the 8254 timer. This may indicate a problem with system hardware. |
| Interrupt Controller-1 Error | BIOS POST could not initialize the Master Interrupt Controller. This may indicate a problem with system hardware. |
| Interrupt Controller-2 Error | BIOS POST could not initialize the Slave Interrupt Controller. This may indicate a problem with system hardware. |

CMOS ERRORS

| Message | Description |
|------------------------|--|
| CMOS Date/Time Not Set | The CMOS Date and/or Time are invalid. This error can be resolved by readjusting the system time in the BIOS Setup Utility. |
| CMOS Battery Low | CMOS Battery is low. This message usually indicates that the CMOS battery needs to be replaced. It could also appear when the user intentionally discharges the CMOS battery. |
| CMOS Settings Wrong | CMOS settings are invalid. This error can be resolved by using the BIOS Setup Utility. |
| CMOS Checksum Bad | CMOS contents failed the Checksum check. Indicates that the CMOS data has been changed by a program other than the BIOS or that the CMOS is not retaining its data due to malfunction. This error can typically be resolved by using the BIOS Setup Utility. |

MISCELLANEOUS ERRORS

| Message | Description |
|--------------------------|---|
| Keyboard Error | Keyboard is not present or the hardware is not responding when the keyboard controller is initialized. |
| Keyboard/Interface Error | Keyboard Controller failure. This may indicate a problem with system hardware. |
| System Halted | The system has been halted. A reset or power cycle is required to reboot the machine. This message appears after a fatal error has been detected. |

**BOOTBLOCK
INITIALIZATION
CODE
CHECKPOINTS**

The Bootblock initialization code sets up the chipset, memory and other components before system memory is available. The following table describes the type of checkpoints that may occur during the Bootblock initialization portion of the BIOS:

| Check-point | Description |
|-------------|--|
| Before | Early chipset initialization is done. Early super I/O initialization is done including RTC and keyboard controller. NMI is disabled. |
| D1 | Perform keyboard controller BAT test. Check if waking up from power management suspend state. Save power-on CPUID value in scratch CMOS. |
| D0 | Go to flat mode with 4GB limit and GA20 enabled. Verify the bootblock checksum. |
| D2 | Disable cache before memory detection. Execute full memory sizing module. Verify that flat mode is enabled. |
| D3 | If memory sizing module not executed, start memory refresh and do memory sizing in Bootblock code. Do additional chipset initialization. Reenable cache. Verify that flat mode is enabled. |
| D4 | Test base 512K memory. Adjust policies and cache first 8MB. Set stack. |
| D5 | Bootblock code is copied from ROM to lower system memory and control is given to it. BIOS now executes out of RAM. |
| D6 | Both key sequence and OEM specific method is checked to determine if BIOS recovery is forced. Main BIOS checksum is tested. If BIOS recovery is necessary, control flows to checkpoint E0. See the <i>Bootblock Recovery Code Checkpoints</i> section of this appendix for more information. |
| D7 | Restore CPUID value back into register. The Bootblock-Runtime interface module is moved to system memory and control is given to it. Determine whether to execute serial flash. |
| D8 | The Runtime module is uncompressed into memory. CPUID information is stored in memory. |
| D9 | Store the Uncompressed pointer for future use in PMM. Copy Main BIOS into memory. Leave all RAM below 1MB Read/Write including E000 and F000 shadow areas but closing SMRAM. |
| DA | Restore CPUID value back into register. Give control to BIOS POST (ExecutePOSTKernel). See the <i>POST Code Checkpoints</i> section of this appendix for more information. |

**BOOTBLOCK
RECOVERY CODE
CHECKPOINTS**

The Bootblock recovery code gets control when the BIOS determines that a BIOS recovery needs to occur because the user has forced the update or the BIOS checksum is corrupt. The following table describes the type of checkpoints that may occur during the Bootblock recovery portion of the BIOS:

| Check-point | Description |
|-------------|--|
| E0 | Initialize the floppy controller in the super I/O. Some interrupt vectors are initialized. DMA controller is initialized. 8259 interrupt controller is initialized. L1 cache is enabled. |
| E9 | Set up floppy controller and data. Attempt to read from floppy. |
| EA | Enable ATAPI hardware. Attempt to read from ARMD and ATAPI CDROM. |
| EB | Disable ATAPI hardware. Jump back to checkpoint E9. |
| EB | Read error occurred on media. Jump back to checkpoint EB. |
| EF | Determine information about root directory of recovery media. |
| E9 or EA | Search for pre-defined recovery file name in root directory. |
| F0 | Recovery file not found. |
| F1 | Start reading FAT table and analyze FAT to find the clusters occupied by the recovery file. |
| F2 | Start reading the recovery file cluster by cluster. |
| F3 | Disable L1 cache. |
| F5 | Check the validity of the recovery file configuration to the current configuration of the flash part. |
| FA | Make flash write enabled through chipset and OEM specific method. Detect proper flash part. Verify that the found flash part size equals the recovery file size. |
| FB | The recovery file size does not equal the found flash part size. |
| F4 | Erase the flash part. |
| FC | Program the flash part. |
| FD | The flash has been updated successfully. Make flash write disabled. Disable ATAPI hardware. Restore CPUID value back into register. Give control to F000 ROM at F000:FFF0h. |
| FF | |

POST CODE CHECKPOINTS

The POST code checkpoints are the largest set of checkpoints during the BIOS pre-boot process. The following table describes the type of checkpoints that may occur during the POST portion of the BIOS:

| Check-point | Description |
|-------------|---|
| 03 | Disable NMI, parity, video for EGA and DMA controllers. Initialize BIOS, POST, Runtime data area. Also initialize BIOS modules on POST entry and GPNV area. Initialize CMOS as mentioned in the Kernel Variable "wCMOSFlags." |
| 04 | Check CMOS diagnostic byte to determine if battery power is OK and CMOS checksum is OK. Verify CMOS checksum manually by reading storage area. If the CMOS checksum is bad, update CMOS with power-on default values and clear passwords. Initialize status register A. Initialize data variables that are based on CMOS setup questions. Initialize both the 8259 compatible PICs in the system. |
| 05 | Initialize the interrupt controlling hardware (generally OPIC) and interrupt vector table. |
| 06 | Do read/write test to CH-2 count register. Initialize CH-0 as system timer. Install the POSTINT1Ch handler. Enable IRQ-0 in PIC for system timer interrupt. Traps INT1Ch vector to "POSTINT1ChHandlerBlock." |
| 08 | Initialize the CPU. The BAT test is being done on KBC. Program the keyboard controller command byte is being done after auto detection of keyboard/mouse using AMI KB-5. |
| 0A | Initialize the 8042 compatible keyboard controller. |
| 0B | Detect the presence of PS/2 mouse. |
| 0C | Detect the presence of keyboard in KBC port. |
| 0E | Testing and initialization of different input devices. Also, update the Kernel variables. Traps the INT09h vector, so that the POST INT09h handler gets control for IRQ1. Uncompress all available language, BIOS logo and silent logo modules. |
| 13 | Early POST initialization of chipset registers. |
| 24 | Uncompress and initialize any platform specific BIOS modules. |
| 30 | Initialize System Management Interrupt. |
| 2A | Initialize different devices through DIM. See <i>DIM Code Checkpoints</i> section of this appendix for more information. |
| 2C | Initialize different devices. Detects and initializes the video adapter installed in the system. |
| 2E | Initialize all the output devices. |
| 31 | Allocate memory for ADM module and uncompress it. Give control to ADM module for initialization. Initialize language and font modules for ADM. Activate ADM module. |
| 33 | Initialize the silent boot module. Set the window for displaying text information. |
| 37 | Display sign-on message, CPU information, setup key message and any OEM specific information. |

**POST CODE
CHECKPOINTS
(CONTINUED)**

| Check-point | Description |
|-------------|--|
| 38 | Initialize different devices through DIM. See <i>DIM Code Checkpoints</i> section of this appendix for more information. |
| 39 | Initialize DMAC-1 and DMAC-2. |
| 3A | Initialize RTC date/time. |
| 3B | Test for total memory installed in the system. Also, check for DEL or ESC keys to limit memory test. Display total memory in the system. |
| 3C | Mid POST initialization of chipset registers. |
| 40 | Detect different devices (parallel ports, serial ports and coprocessor in CPU, etc.) successfully installed in the system and update the BDA, EBDA, etc. |
| 50 | Program the memory hole or any kind of implementation that needs an adjustment in system RAM size if needed. |
| 52 | Updates CMOS memory size from memory found in memory test. Allocates memory for Extended BIOS Data Area from base memory. |
| 60 | Initialize NUM-LOCK status and program the keyboard Typematic rate. |
| 75 | Initialize INT13 and prepare for IPL detection. |
| 78 | Initialize IPL devices controlled by BIOS and option ROMs. |
| 7A | Initialize remaining option ROMs. |
| 7C | Generate and write contents of ESCD in NVRAM. |
| 84 | Log errors encountered during POST. |
| 85 | Display errors to the user and get the user response for error. |
| 87 | Execute BIOS setup if needed/requested. |
| 8C | Late POST initialization of chipset registers. |
| 8E | Program the peripheral parameters. Enable/disable NMI as selected. |
| 90 | Late POST initialization of system management interrupt. |
| A0 | Check boot password if installed. |
| A1 | Clean-up work needed before booting to OS. |
| A2 | Take care of runtime image preparation for different BIOS modules. Fill the free area in F00h segment with 0FFh. Initialize the Microsoft IRQ Routing Table. Prepare the runtime language module. Disable the system configuration display if needed. |
| A4 | Initialize runtime language module. |

**POST CODE
CHECKPOINTS
(CONTINUED)**

| Check-point | Description |
|-------------|--|
| A7 | Display system configuration screen if enabled. Initialize the CPU before boot, which includes the programming of the MTRRs. |
| A8 | Prepare CPU for OS boot, including final MTRR values. |
| A9 | Wait for user input at configuration display if needed. |
| AA | Uninstall POST INT1Ch vector and INT09h vector. Deinitialize the ADM module. |
| AB | Prepare BBS for INT19 boot. |
| AC | End of POST initialization of chipset registers. |
| B1 | Save system context for ACPI. |
| 00 | Pass control to OS Loader (typically INT19h) |

**DIM CODE
CHECKPOINTS**

The Device Initialization Manager module gets control at various times during BIOS POST to initialize different buses. The following table describes the main checkpoints where the DIM module is accessed:

| Check-point | Description |
|-------------|---|
| 2A | Initialize different buses and perform the following functions: Reset, Detect and Disable (function 0); Static Device Initialization (function 1); Boot Output Device Initialization (function 2). Function 0 disables all device nodes, PCI devices and PnP ISA cards. It also assigns PCI Bus numbers. Function 1 initializes all static devices, which include manually configured on-board peripherals, memory and I/O decode windows in PCI-to-PCI bridges and non-compliant PCI devices. Static resources are also reserved. Function 2 searches for and initializes any PnP, PCI or AGP video drivers. |
| 38 | Initialize different buses and perform the following functions: Boot Input Device Initialization (function 3); IPL Device Initialization (function 4); General Device Initialization (function 5). Function 3 searches for and configures PCI input devices and detects if system has standard keyboard controller. Function 4 searches for and configures all PnP and PCI boot devices. Function 5 configures all on-board peripherals that are set to an automatic configuration and configures all remaining PnP and PCI devices. |

**ADDITIONAL
CHECKPOINTS**

While control is in the different functions, additional checkpoints are output to Port 80H as word values to identify the routines being executed.

The low byte value indicates the main POST Code Checkpoint. The high byte is divided into two nibbles and contains two sets of information. The details of the high byte of these checkpoints are detailed in the following table:

HIGH BYTE XY

The upper nibble 'X' indicates the function number that is being executed. 'X' can be from 0 to 7.

| | |
|---|--|
| 0 | Function 0. Disable all devices on the bus. |
| 1 | Function 1. Initialize static devices on the bus. |
| 2 | Function 2. Initialize output devices on the bus. |
| 3 | Function 3. Initialize input devices on the bus. |
| 4 | Function 4. Initialize IPL devices on the bus. |
| 5 | Function 5. Initialize general devices on the bus. |
| 6 | Function 6. Error reporting for the bus. |
| 7 | Function 7. Initialize add-on ROMs for all buses. |
| 8 | Function 8. Initialize BBS ROMs for all buses. |

The lower nibble 'Y' indicates the bus on which the different routines are being executed. 'Y' can be from 0 to 5.

| | |
|---|---|
| 0 | Generic DIM (Device Initialization Manager) |
| 1 | On-board system devices |
| 2 | ISA devices |
| 3 | EISA devices |
| 4 | ISA PnP devices |
| 5 | PCI devices |

This page intentionally left blank.