

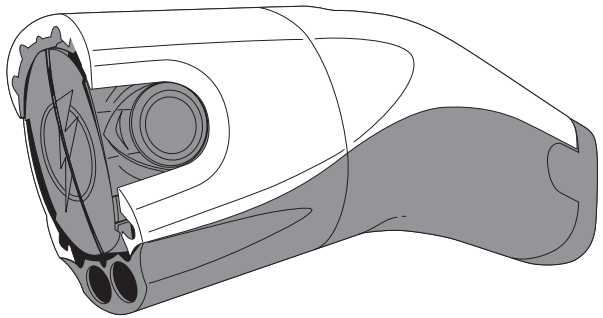

# TASER® C2™ ECD

## User Manual



### **IMPORTANT SAFETY INSTRUCTIONS.**

Read all warnings and instructions in this manual. Save these instructions.

MMU0010 Rev: C

# Contents

- 4 Chapter 1: Warnings**
- 4 Important Safety and Health Information
- 4 Scope and Purpose
- 5 Safety Information: ECD Deployment and Use
- 7 ECD Known and Potential Side Effects
- 8 Probe or Electrode Injury or Infection
- 9 General Precautions
- 10 Maintenance
- 10 Hazardous Substances
  
- 11 Chapter 2: Ownership**
  
- 12 Chapter 3: General Information**
- 12 What Is the TASER C2 ECD?
- 12 Neuro Muscular Incapacitation (NMI)
- 12 Secondary Injuries
- 13 Basic C2 Electrical Theory
  
- 14 Chapter 4: TASER C2 ECD and Cartridge Features**
- 14 Safety Cover
- 15 Power Supply
- 15 Power LED
- 15 Trigger Button
- 16 Spark Duration
- 16 Electrodes
- 16 LASER and LED
- 17 Hard Case
- 17 TASER C2 Cartridge
- 17 TASER C2 Simulation Cartridges
- 17 Avoiding Unintentional Discharge
- 18 Protective Anti-Felon Identification (AFID) Tags
- 18 Activating a New TASER C2 ECD (U.S. Only)
- 18 Obtaining an Activation Code (U.S. Only)
- 19 Spark Test
- 19 Load the C2 Cartridges
- 20 Unloading Cartridges
- 21 Practicing with the C2 ECD
- 21 Aiming and Probe Placement for Self-Defense
- 22 Using the C2 ECD
- 22 Deployment Instructions for Self-Defense

- 23 What if I Miss?
- 23 "Silence is Golden"
- 23 Potential Causes of Reduced or No Effectiveness
- 24 Drive-Stun Backup
- 24 Recommended Drive-Stun Areas for Maximum Effect

**25 Chapter 5: C2 Maintenance and Care**

- 25 General Concepts
- 25 Changing the LPM Battery Pack
- 25 Dropped or Wet C2 ECD

**27 Chapter 6: Additional Items**





- 27 Product Support
- 27 Additional Information
- 27 Legality
- 27 Warranty

# Warnings

# 1

## Important ECD Product Safety and Health Information

These safety warnings are for your protection as well as the safety of others. Disregarding this information could result in death or serious injury.<sup>1</sup>

 <b>WARNING</b>	
	<b>Complete Training First</b> Significant differences exist between each of the TASER International, Inc. ("TASER") Electronic Control Device ("ECD") models. Do not Use <sup>2</sup> or attempt to Use any ECD model unless you have read and understand all instructions and have viewed any applicable training DVD in its entirety.
	<b>Read and Obey</b> Read, study, understand, and follow all instructions, training materials, product manuals, and warnings, before Using the TASER® ECD. Failure to comply with the instructions, training materials, product manuals, and warnings could result in death or serious injury to the User, force recipient, and others.
	<b>Obey Applicable Laws</b> Use the ECD only in accordance with applicable federal, state, local laws and other regulations or legal requirements. Any Use of an ECD must be legally justifiable.
	<p><b>These warnings are effective May 31, 2010, and supersede all prior revisions. The most current warnings are online at <a href="http://www.TASER.com">www.TASER.com</a>.</b></p> <div style="border: 1px solid black; padding: 5px;"><div style="display: flex; align-items: center;"><div style="flex: 1;"></div><div style="flex: 2; padding-left: 10px;"><p style="text-align: center;"><b>WARNING</b></p><p><b>Electronic Control Device</b></p><ul style="list-style-type: none"><li>• Can temporarily incapacitate target.</li><li>• Can cause injury.</li><li>• Obey warnings, instructions and all laws.</li><li>• Comply with current training materials and requirements.</li><li>• See <a href="http://www.TASER.com">www.TASER.com</a>.</li></ul></div></div><p style="text-align: center; font-size: small;"><i>This warning label appears on newer ECD models.</i></p></div>

## Scope and Purpose

This document presents important safety warnings, instructions, and information intended to reasonably minimize hazards associated with ECD deployment, intended Use, side effects, and environment of Use.

When lawfully Used as directed, ECDs are designed in probe-deployment mode to temporarily incapacitate a person from a safer distance than some other force options, while reducing the likelihood of death or serious injury. Any use of force, physical exertion, capture, control, restraint, or incapacitation involves risks that a person may get hurt or die.

Within this document certain safety signals and signal words are used to call attention to safety messages:

<sup>1</sup> These warnings are state of the art but cannot address all possible ECD application circumstances or permutations. They are intended to inform Users about reasonably foreseeable potential risks of harm. The decision to Use the ECD in a particular manner or circumstance must follow applicable legal standards. These warnings do not create a standard of care. Herein, the singular is also the plural, the plural includes the singular, and the masculine is also the feminine.

<sup>2</sup> The terms "Use," "Used," "Using," or "User" include, but are not limited to: acquiring; accessing; entrusting; providing; possessing; storing; handling; manipulating; carrying; holstering; drawing; brandishing; displaying; deploying; utilizing; drive-stunning; using alligator or other types of clips or attachments; or discharging an ECD.



The safety alert symbol is used to alert Users to potential injury hazards. ALWAYS obey all safety messages that follow this symbol to reasonably minimize the risk of death or serious injury when the ECD is Used and to enhance safe operation of the ECD.



## WARNING

The signal word WARNING indicates a hazardous situation which, if not avoided or heeded, could result in death or serious injury. It is intended to direct the User's attention to hazards that may not be obvious, but may be reasonably mitigated by heeding training and instructions, or avoiding certain actions, circumstances, or behaviors, thereby improving the safety of the ECD. WARNINGS may be followed by instructions and information integral to the WARNING.

## Safety Information: ECD Deployment and Use



### WARNING



#### Minimize Repeated, Continuous, or Simultaneous<sup>3</sup> Exposures

Reasonable efforts should be made to minimize the number of ECD exposures. ECD Users should use the lowest number of ECD exposures that are objectively reasonable to accomplish lawful objectives and should reassess the subject's resistance level before initiating or continuing the exposure.



#### Sensitive Body Part Hazard

When possible, avoid intentionally targeting the ECD on sensitive areas of the body such as the head, throat, chest/breast, or known pre-existing injury areas without legal justification. The preferred target areas are the lower center mass (below chest) for front shots and below the neck area for back shots.



#### Perform Spark Test

ECDs must be safely spark tested every 30-60 days.



#### Avoid Misuse

Use an ECD only for its intended purpose and in legally justifiable situations. Misuse can result in criminal prosecution or civil litigation.



#### Never Confuse Handgun with ECD

Confusing a handgun with an ECD could result in death or serious injury. Learn the difference in the physical feel and holstering characteristics between ECDs and handguns. This should help avoid confusion in the identification, selection, and discharge of the ECD during stressful situations.



#### Be Aware of Trigger-Held Continuous Discharge

If an ECD's trigger is held back it can continue to discharge beyond the pre-programmed cycle until the trigger is released or the power source is expended. Know the pre-programmed cycle for your model ECD.

<sup>3</sup> "Simultaneous" means delivery to the body of electrical charge by multiple ECDs or multiple completed circuits at the same time.



## Be Aware that an ECD or Cartridge May Fail to Fire, Operate, or Be Effective

No weapons system, tool, technique, or ECD is always effective. If an ECD, cartridge, or accessory is inoperable, fails to function, or the intended ECD application is ineffective in achieving the desired effect, consider reloading and redeploying, using other force options, disengaging, or using other alternatives. The failure of the ECD to fire, operate, or be effective could result in death or serious injury.



## Prepare to Redeploy ECD or Use Backup Plan

Always prepare to redeploy the ECD or Use a backup plan. Be familiar with backup plans and acceptable alternatives in the event of ineffective deployment.



## Incapacitation, Falling, and Startle Hazard

ECD Use may cause muscular contraction, Neuro Muscular Incapacitation ("NMI"), startling, and falling, which could result in death or serious injury.



## NMI and Secondary Injuries



An ECD may cause NMI if probes are within sufficient proximity to complete a circuit, with sufficient spread, and an adequate circuit is completed and maintained rendering the subject temporarily unable to control movement and may cause a fall. Also, ECD use may cause a startle response. This loss of control or startle may increase risk of death or serious injury resulting from loss of balance, fall, change in momentum, drowning, or loss of control of any mode of transportation, conveyance, or machinery. Especially at risk is a person who:

- could fall and suffer impact injury to the head or other sensitive area;
- is on an elevated or unstable surface (e.g., tree, roof, ladder, ledge, balcony, porch, bridge, crane, dock, chair, bunk bed, or stair);
- is less able to catch or protect self in a fall (e.g., restrained, incapacitated, or immobilized);
- could fall on a sharp object (e.g., holding a knife or other edged weapon or sharp object on ground);
- is running, in motion, or moving under momentum;
- is operating or riding in or on any mode of transportation (e.g., vehicle, bus, bicycle, motorcycle, cart, train, or airplane), conveyance (e.g., escalator, moving walkway, elevator, skateboard, skates, or rollerblades), or machinery;
- is located in water, mud, or marsh environment if the ability to move is restricted; or
- is physically infirm, elderly, or pregnant.



## Eye Injury Hazard



If a TASER probe, electrode or electrical discharge contacts or comes into close proximity to an eye it could result in serious injury, including permanent vision loss. DO NOT intentionally aim an ECD at the eye of a person or animal without justification.



## Laser Light Could Result in Serious Eye Injury

Some TASER ECD models use a LASER as a targeting aid. Avoid intentionally aiming the LASER at the eye of a person or animal without justification. NEVER aim the LASER at aircraft.











## Fire and Explosion Hazard



ECD Use could result in a fire or explosion when flammable gases, fumes, vapors, liquids, or materials are present. An ECD can ignite explosive and flammable clothing or materials, liquids, fumes, gases, or vapors (e.g., gasoline, vapor or gas found in sewer lines or methamphetamine labs, butane-type lighters, or flammable hair gels). Do not knowingly Use an ECD in the presence of any explosive or flammable substance without legal justification. Note that some self-defense sprays use a flammable carrier, such as alcohol.



## Safety Information: ECD Known and Potential Side Effects

 <b>WARNING</b>	
 Always follow and comply with all instructions, warnings, information, and current TASER training materials to reasonably minimize the risks associated with possible Use and side effects listed below.	
	<p><b>Muscle Contraction or Strain-Related Injury</b></p> <p>ECDs can cause strong or moderate muscle contractions that may result in physical exertion, athletic, or sport-type injury, including, but not limited to, injury such as hernia, rupture, dislocation, tear, or other injury to soft tissue, organ, muscle, tendon, ligament, nerve, bone, or joint. Fracture to bone, including compression fracture to vertebrae, may occur. These injuries may be more serious and more likely to occur in people with pre-existing injuries, conditions or special susceptibilities, which include but are not limited to, known or unknown: pregnancy; osteopenia; osteoporosis; spinal injury; or previous muscle, disc, ligament, joint, bone, or tendon damage or surgery. Such injuries may also occur when a person reacts to the ECD deployment or discharge by making a rapid movement.</p>
	<p><b>Physiologic or Metabolic Effects</b></p> <p>The ECD can produce physiologic or metabolic effects which include, but are not limited to, changes in: acidosis; adrenergic states; blood pressure; calcium, creatine kinase ("CK"); electrolytes (including potassium), heart rate and rhythm; lactic acid; myoglobin; pH; respiration; stress hormones or other biochemical neuromodulators (e.g., catecholamines). Reasonable effort should be made to minimize the number of ECD exposures and resulting physiologic and metabolic effects. In human studies of electrical discharge from a single ECD of up to 15 seconds, these effects on acidosis, CK, electrolytes, stress hormones, and vital signs have been comparable to or less than changes expected from physical exertion similar to struggling, resistance, fighting, fleeing, or from the application of some other force tools or techniques. Adverse physiologic or metabolic effects may increase risk of death or serious injury.</p>
	<p><b>Higher Risk Populations</b></p> <p>ECD Use on a pregnant, infirm, elderly, small child, or low body-mass index (BMI) person could increase the risk of death or serious injury. ECD Use has not been scientifically tested on these populations. The ECD should not be Used on members of these populations unless the situation justifies possible higher risk of death or serious injury.</p>
	<p><b>Neurocardiogenic Response (Fainting)</b></p> <p>A person may experience an exaggerated response to an ECD exposure, or threatened exposure, which may result in a person fainting or falling with possible secondary injury.</p>
	<p><b>Seizure</b></p> <p>Repetitive stimuli (e.g., flashing light or electrical stimuli) can induce seizure in some people. This risk may be increased in a person with seizure history or if electrical stimuli pass through the head area. This may also result in a person falling with a possible secondary injury.</p>
	<p><b>Stress and Pain</b></p> <p>The ECD can cause temporary discomfort, pain, stress, panic, or startle which may be injurious to some people. Anticipation of ECD exposure can cause stress, trepidation, panic, startle, or fear, which may also be injurious to some people.</p>

## Safety Information: Probe or Electrode Injury or Infection

 <b>WARNING</b>	
	<p><b>Probe or Electrode Injury or Infection Hazard</b> ECD Use may cause a mark, burn, scar, penetration, other skin, or tissue damage or infection. Medical care may be required.</p>
	<p><b>Scarring</b> Use of an ECD may cause irritation, puncture, mark, abrasion, rash, burn, keloid, or other scarring that may be permanent. This risk may be increased when using the C2, M26C, or X26C ECD in drive-stun mode with the cartridge removed or the X3C ECD in drive-stun mode due to the multiple sets of electrical contacts. The nature and severity of these effects depends on the area of exposure and method of application, individual susceptibility, and other circumstances surrounding ECD Use, exposure, and after care.</p>
	<p><b>Penetration Injury</b> The TASER probe has a small dart point which may cause a penetration injury to a blood vessel or internal organ (including lung, bone, or nerve). The probe or dart point (which may detach) can also puncture or become embedded into a bone, organ, or tissue, which may require immediate medical attention, surgical removal, or may result in scarring, infection, or other serious injury.</p>
	<p><b>Penetration Injury Care</b> Injury due to penetration of the probe or dart point into a blood vessel, organ, nerve, or bone may require medical attention. A probe, dart point, or barb embedded in a sensitive area such as the eye, the genital area, breast, neck, throat, or vascular structure may cause serious injury and may require special medical attention and further evaluation.</p>
	<p><b>Probe Removal</b> Probe removal may cause injury. Leaving a probe in the body may result in pain or injury. In the case of embedment, organ or bone penetration, or probe, dart point, or barb detachment, immediate medical attention and possible surgical removal may be required.</p>
	<p><b>Skin, Wound, or Infection Treatment</b> ECD Use may cause a skin irritation, puncture wound, abrasion, mark, rash, burn, keloid or other scar which may require medical attention and may be permanent. As with any injury of this type, infection or tetanus may occur in some circumstances.</p>
	<p><b>Biohazards</b> Utilize appropriate biohazard protocols and personal protective equipment including gloves, masks, and washing of hands and exposed areas as necessary.</p>
	<p><b>Untethered Discharged Probe</b> In probe deployment, it is possible that a discharged probe that does not impact a subject or target may become untethered from the wire and travel a significant distance. A loose, untethered probe can cause serious injury.</p>



## Safety Information: General Precautions

### **WARNING**



#### **Unintentional Deployment Hazard**

Unintentional ECD activation could result in death or serious injury to the User and others. Follow and comply with the following instructions to reduce the risk of unintentional Use, deployment, or activation.



#### **Store In A Secure Location**

Store ECDs, cartridges, and accessories in secure locations inaccessible to children and other unauthorized persons to prevent inappropriate Use, which may result in death or serious injury to the User, other persons, or animals. ECDs, cartridges, and accessories are weapons and are not toys.



#### **Use Of ECD Safety**

Always place the ECD safety switch in the SAFE position when not in Use. Remember to place the ECD safety switch in the ARMED position when you intend to Use the ECD.



#### **Assume ECD Is Loaded**

Always assume that an ECD is loaded and capable of discharging. To avoid unexpected discharge, ensure that no live cartridge is in the ECD when inserting: a battery; DPM™; EPM™, LPM™, XDPM™ battery pack; TASER CAM™ recorder; or while performing spark tests for the C2, M26C, or X26C ECDs; maintenance; data downloading; or battery charging.



#### **Be Aware Of ECD Deployment Mode**

Keep your finger off the trigger until it is legally justifiable to use the ECD. Be aware of the deployment mode (manual or semi-automatic) set on the X3C ECD before discharging that ECD.



#### **Trigger**

Keep your finger off the trigger until it is legally justifiable to use the ECD.



#### **Keep Body Parts Away From Front of ECD or Cartridge**

Keep your hands and body parts away from the front of the ECD and cartridge, unless instructed otherwise. A discharging ECD or cartridge could result in serious injury.



#### **Avoid Touching Probes/Wires During Discharge**

User should avoid touching the probes and wires and the areas between the probes during the ECD's electrical discharge.



#### **Avoid Static Electricity**

Keep the cartridge away from sources of static electricity. Static electricity can cause the ECD or C2, X26C, or M26C cartridge to discharge unexpectedly, which could result in serious injury.



#### **Beware of Electronic Equipment Interference**







Interference from electronic transmission equipment in close proximity to the ECD could interfere with the proper operation of the ECD and cause the ECD to discharge. Keep the ECD at least several inches away from other electronic equipment. Place the ECD safety switch in the SAFE position whenever it is immediately adjacent to electronic equipment (including transmitting radios and cell phones). Remember to place the ECD safety switch in the ARMED position prior to attempting Use.





#### **Avoid Dropping ECD or Cartridge**

If an ECD or cartridge is dropped or damaged it may unintentionally deploy or discharge, become inoperable, or fail to function, making it unsafe for continued use. If an ECD or cartridge has been dropped or damaged, refer to the product manual.

## Safety Information: Maintenance

 <b>WARNING</b>	
 Failure to maintain an ECD as instructed may cause the ECD to malfunction or fail to function optimally and could result in death or serious injury. Follow and comply with the following instructions to reduce the risk of ECD malfunction, including failure.	
	<b>Damaged ECD or Cartridge</b> Do not use a cartridge with a missing blast door unless facing an immediate threat. ECD repair or modification by an unauthorized person may cause the ECD to fire or malfunction, will void the warranty, and may put the User or other person at risk of death or serious injury.
	<b>Update ECD Software</b> Some ECDs, including the TASER X3C and X26C, have the capability for software updating. It is important to acquire, update, and maintain the latest ECD software update. Current ECD software may be obtained by contacting TASER's Customer Service Department.
	<b>Use Only TASER-Approved Components, Batteries, Accessories, and Cartridges</b> The ECD is a sophisticated electronic system. In order to provide proper function, only TASER-approved components, batteries, accessories, and cartridges are to be used with the ECD. Use of anything other than TASER-approved components, batteries, accessories, and cartridges will void the warranty, may cause malfunction, and may put the User or other person at risk of death or serious injury.
	<b>Avoid Exposure to Wet Conditions</b> If the ECD is drenched or immersed in water or other liquid, DO NOT Use the ECD until completing the procedure recommended in the product manual. Incidental exposure to moisture, such as brief exposure to moderate rain, should not unduly affect the operation of the ECD.

## Safety Information: Hazardous Substances

 <b>WARNING</b>	
 <b>Hazardous Substances</b> The ECD contains components that contain chemicals known to the State of California and others to cause cancer and birth defects or other reproductive harm. Do not disassemble.	
	

The C2 ECD is shipped in a pre-active mode and will not be usable until a background check is completed. See the *Activating a New TASER C2 ECD (U.S. Only)* section for more details.

Do not give a TASER ECD away as a gift or sell it without filling in the registration card or transfer card. Do not give or sell a TASER ECD to anyone not authorized to own it. For more information, see the *Legality* section of this manual.

Taking a TASER-brand ECD out of the United States without the proper export license is prohibited by law (similar prohibitions may exist in other countries too).

If traveling on an airplane (domestic U.S.), you must put the TASER ECD in your checked luggage; it cannot be carried on board. Although the TASER ECD is not classified as a firearm by the U.S. Bureau of Alcohol, Tobacco, Firearms and Explosives (BATFE), you should carry the C2 ECD in a hard case and advise the Transportation Security Administration (TSA) and airline personnel prior to bag screen that you are carrying the TASER ECD in your checked baggage.

Do not point the ECD at any law enforcement officer or do anything that would cause law enforcement officers to feel threatened by your use of the TASER ECD. Because the TASER ECD is able to incapacitate a person, law enforcement officers may be justified to use lethal force to protect themselves.

It is recommended that you carry the C2 ECD only in a manufacturer approved holster or carrying case. Do not carry C2 cartridges in your pockets as they can be fired by electrostatic discharge (static electricity).

## What Is the TASER C2 ECD?

The TASER C2 ECD is a self-defense electronic control device manufactured by TASER International, Inc. TASER brand ECDs use propelled wires or direct contact to conduct energy to affect the sensory and motor functions of the nervous system.

The C2 ECD uses a replaceable cartridge containing compressed nitrogen to deploy two small probes that are attached to the C2 cartridge by insulated conductive wires with a maximum length of 15 feet (4.6 m). The C2 ECD transmits electrical pulses along the wires and into the body affecting the sensory and motor functions of the peripheral nervous system. The energy can penetrate up to 2 cumulative inches (5 cm) of clothing, or 1 inch (2.5 cm) per probe.

## Neuro Muscular Incapacitation (NMI)

The human nervous system communicates with simple electrical impulses. The command center (brain and spinal cord) processes information and makes decisions. The peripheral nervous system includes the sensory and motor nerves. The sensory nerves carry information from the body to the brain (e.g., temperature, touch, etc.). The motor nerves carry commands from the brain to the muscles to control movement and can be involuntary in response to the sensory information. An example would be the involuntary muscle reaction to pull a hand away from a hot object.

TASER technology uses similar electrical pulses to cause stimulation that affects the sensory and motor nerves. NMI occurs when an ECD is able to cause involuntary stimulation of both the sensory nerves and the motor nerves. It is not dependent on pain and is effective on subjects with a high level of pain tolerance. Previous generations of stun guns could primarily affect the sensory nerves only, resulting in pain compliance. A person with a very high tolerance to pain (e.g., a drug abuser or a trained, focused fighter) might be able to fight through the pain of a traditional stun gun.

An ECD may cause NMI if probes are within sufficient proximity to complete a circuit, the probes have a sufficient spread, and an adequate circuit is completed and maintained rendering the subject temporarily unable to control movement.

## Secondary Injuries

ECD use may cause a fall or startle response. This loss of control or startle may increase risk of death or serious injury resulting from loss of balance, fall, change in momentum, drowning, or loss of control of any mode of transportation, conveyance, or machinery. Especially at risk is a person who:

- could fall and suffer impact injury to the head or other sensitive area;
- is on an elevated or unstable surface (e.g., tree, roof, ladder, ledge, balcony, porch, bridge, crane, dock, chair, bunk bed, or stair);

- is less able to catch or protect self in a fall (e.g., restrained, handcuffed, incapacitated, or immobilized);
- could fall on a sharp object (e.g., holding a knife or other edged weapon or sharp object on ground);
- is running in motion, or moving under momentum;
- is operating or riding in or on any mode of transportation (e.g., vehicle, bus, bicycle, motorcycle, cart, train, or airplane), conveyance (e.g., escalator, moving walkway, elevator, skateboard, skates, or rollerblades), or machinery;
- is located in water, mud, or marsh environment if the ability to move is restricted; or
- is physically infirm, elderly, or pregnant.

## Basic C2 Electrical Theory

- Electricity must be able to flow between the probes or the electrodes.
- Electricity generally follows the path of least resistance between the probes.
- The greater the spread between the probes on the target, generally the greater the NMI effectiveness.
- Electricity will generally not pass to others in contact with the subject unless contact is made directly between or on the probes or the wires are touched.
- Electricity can arc through clothing.
- Exposure to water will not cause electrocution or increase the power to the subject (the electrical charge is fixed inside the ECD, and will not increase significantly even with environmental changes).

Medical studies have found that modern pacemakers and implanted cardiac defibrillators withstand external electrical defibrillators many orders of magnitude stronger than the TASER conducted energy pulses.

# TASER C2 ECD and Cartridge Features

The C2 ECD is constructed of impact-resistant sonic welded polymer and weighs approximately 7 ounces (198 grams). Various color options are available.

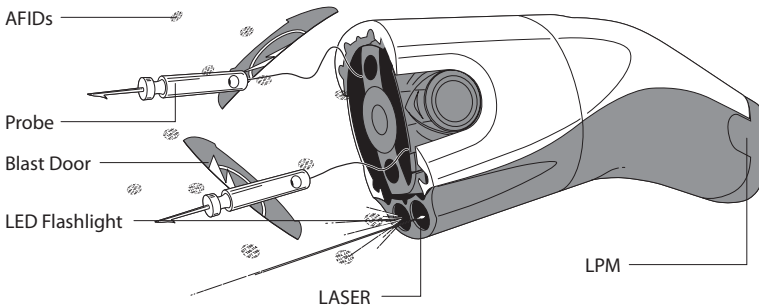

## Safety Cover

The sliding cover acts as a safety switch to minimize the possibility of inadvertent activation of the trigger button. When the cover is open, the trigger button is exposed, the unit is ARMED, and a green LED illuminates to indicate power to the ECD.

- Safety cover closed (SAFE).
- Safety cover open (ARMED) and ready to deploy. Be sure to slide the safety cover all the way open.
- If the C2 safety cover is left in the open (ARMED) position for more than 20 minutes, the system will shut down to preserve LPM battery life.
- To re-arm the C2 ECD, simply move the safety cover to the closed (SAFE) position, then back to the open (ARMED) position.

Open (ARMED)



Closed (SAFE)

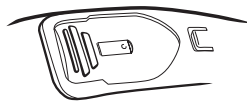

## Power Supply

The Lithium Power Magazine (LPM™) is a lithium energy cell power supply system (battery) for the C2 ECD. For low battery detection, the C2 ECD will momentarily load the battery when first powered up (ARMED). The microcontroller will then sense the battery voltage and determine whether or not the battery is marginal or operating in a marginal condition (-20 °C). The C2 ECD will then light the green LED to indicate a “good” battery or the yellow LED for a “bad” battery.

Do not store the LPM battery pack anywhere that the gold contacts on the top of the LPM battery pack may touch metal objects. If the LPM battery pack is short-circuited, it will malfunction and the energy lost during the short circuit will not be registered or tracked in the LPM battery pack.

The LPM battery has enough power for approximately 50 30-second firings depending on temperature and other factors. The LPM battery will use more energy in colder weather than in warm weather.

## Power LED

The power LED is located under the Safety Cover. A green LED indicates the trigger button is ARMED. A red LED indicates that the ECD has not been activated and is not armed. A yellow LED indicates a “bad” battery.

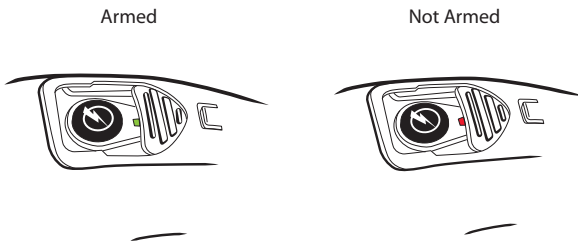

## Trigger Button

The trigger button is located under the safety cover and is ARMED when the safety cover is in the open position. If the C2 ECD has not been activated, the trigger button is used to enter the authorization code. After the code has been entered, momentarily depressing the trigger button results in an automatic discharge of approximately 30 seconds unless the safety cover is moved to the closed (SAFE) position.

**⚠ WARNING**

In the event of an unintentional discharge, immediately move the safety cover to the closed (SAFE) position to stop the discharge cycle.

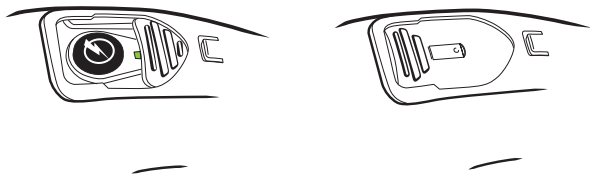

## Spark Duration

When the C2 ECD is deployed, it delivers an approximately 30-second Shaped Pulse™ energy burst of short-duration electrical pulses.

## Electrodes

The front of the C2 ECD has two metal electrodes. These electrodes direct the charge to the electrodes on the cartridge to initiate deployment of the probes. In addition, the electrodes provide the ability to use the C2 ECD in a “drive-stun” mode as a traditional stun gun-type ECD.

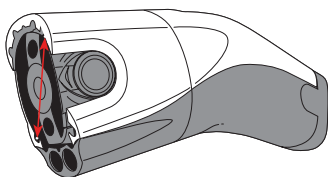

## LASER and LED

The LED illuminates whenever the safety cover is open. In addition, the optional LASER provides assistance for aiming and is the approximate orientation of the top probe.

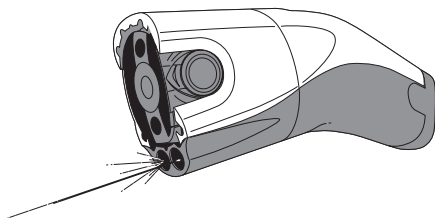



## Hard Case

A black hard case holster is available for the C2 ECD.

## TASER C2 Cartridge

15-foot (4.6 m) cartridges are available for the C2 ECD.



## TASER C2 Simulation Cartridges

C2 simulation cartridges are identifiable by their blue color. Simulation cartridges are intended for practice only. **DO NOT use a C2 ECD loaded with a simulation cartridge for self-defense.** Simulation cartridges use non-conductive nylon line and will not transmit electrical pulses to the probes. A simulation cartridge will have no NMI effect on an attacker.

Use C2 standard cartridges, which are black in color, for self-defense.

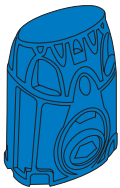

## Avoiding Unintentional Discharge



**Never attempt to open or modify a C2 cartridge. Tampering with a live C2 cartridge could cause it to fire or malfunction, which may result in serious injury.**

Handle all C2 cartridges with care. Probes may deploy unexpectedly if exposed to physical shock.

Additionally, the firing sequence for all C2 cartridges is designed to be initiated by an electrostatic discharge delivered by the TASER ECD. This is an important design and functional element for the C2 ECD and cartridge. However, an electrostatic discharge can come from many sources such as rubbing cloth (i.e., jacket liner) across a cartridge in an environment known to create static shocks. When an

electrostatic discharge, regardless of the source, contacts the front of a C2 cartridge, it is possible for the cartridge to discharge (and even to discharge when not inserted into the ECD). Therefore, avoid contact between static electricity and the C2 cartridge because static electricity can cause unexpected discharge.

Occasionally, blast doors will be knocked off the front of a cartridge. Because those cartridges cannot be relied upon to discharge, TASER International recommends disposing of these cartridges. TASER ECD operators should not attempt to fire a cartridge with no blast doors on it unless they are facing an immediate threat and do not have the time or option to reload. Attempting to deploy a cartridge with no blast doors could result in a charge being created and held in the wires. Any conductive material that comes into contact with the front of the cartridge, even after the cycle has ended, could draw the charge to the ignition pin and deploy the probes.

## Protective Anti-Felon Identification (AFID) Tags

Every time a C2 cartridge is deployed, 20–30 small confetti-like AFID tags are ejected. Each AFID tag is printed with the serial number of the cartridge deployed, allowing law enforcement agencies to determine the registered owner of the cartridge and track use if ever used in a criminal act.



## Activating a New TASER C2 ECD (U.S. Only)

The C2 ECD is shipped in a pre-active mode, and will not discharge until the background check is complete and the unique activation code is entered in the C2 ECD.

## Obtaining an Activation Code (U.S. Only)



**DO NOT LOAD THE CARTRIDGE PRIOR TO ACTIVATION. If you have already done this, please see the unloading instructions in this manual on how to safely remove the cartridge.**

1. Go to [www.TASER.com/C2](http://www.TASER.com/C2) activation.
2. Complete the online instructions to complete the criminal background check. NOTE: A credit inquiry will NOT be generated. The background check is for felony convictions.
3. Be sure to enter the complete serial number for your C2 ECD during the activation registration. Each serial number is unique and linked only to your ECD.
4. After the background check is successfully completed, you will receive your five-digit activation code and can proceed through a step-by-step online tutorial to enter the code into your C2 ECD.
5. Follow all the instructions on your screen to activate your C2 ECD, or call TASER International at 1.888.TASER88 (1.888.827.3788) if you need assistance with the activation process.

## Spark Test

A spark test should be conducted several times a month during the first 90 days of ownership, and then at least once every six months thereafter. The reasons for the spark test include:

- To verify the C2 ECD is working.
  - To verify that the LPM battery is in good condition.
1. Confirm that the safety cover is in the closed (SAFE) position.
  2. Confirm that the C2 cartridge is removed. A spark test should never be conducted with a C2 cartridge in the ECD.
  3. Point the ECD in a safe direction (such as the floor) and ensure that your fingers and no part of your body are in front of the ECD.
  4. Place the safety cover in the open (ARMED) position.
  5. Depress the trigger button and confirm sparking across the electrodes at a rapid rate. You do not need to spark test the ECD for the full 30 seconds.
  6. Place the safety cover in the closed (SAFE) position.

## Load the C2 Cartridges



**Never place your hands, fingers, or any part of your body in front of the cartridge. When loading and unloading, always hold the cartridge on the sides.**

1. Ensure that the safety switch is in the closed (SAFE) position.
2. Point the ECD in a safe direction.
3. Remove the cartridge cover.

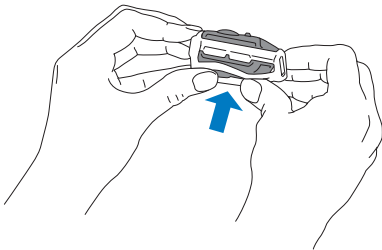

- Place the cartridge into the front of the ECD, until it is approximately 90 percent inserted.

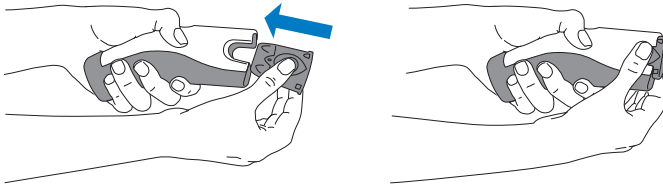

- Gently press the cartridge against a firm, flat surface until it locks into place.

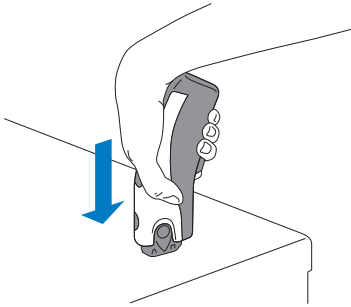

- Confirm that the cartridge is secure by gently pulling on the sides of the cartridge.

## Unloading Cartridges

The C2 cartridge is designed to ensure a secure fit when inserted in the C2 ECD. The placement of the wire bundles behind the insertion tabs aids in providing a secure fit. It is very difficult to remove a cartridge with the wire in place (that is, when the cartridge has not been deployed). To remove a live cartridge, follow these steps:

- Ensure that the safety cover is in the closed (SAFE) position.
- Ensure that the front of the C2 ECD is pointed in a safe direction.
- Do not place any part of your hands or other body parts in front of the C2 ECD.
- Depress both tabs until the cartridge releases. Note that it might take two hands to depress the tabs.
- Re-install the clear cartridge cover on the cartridge.

Removal of an expended cartridge does not require as much force because the wires are no longer behind the tabs.

The cartridges for the C2 ECD are specifically designed so there is no “up” or “down” position – enabling you to quickly reload one in a stressful situation without worrying about putting it in upside down.

## Practicing with the C2 ECD

Be aware of your surroundings when deciding where to place your training target. Ensure that the target has a firm backing that will allow the probes to stick and not bounce off and strike an unintended person or object. Do not place the target anywhere a probe that misses or penetrates the target could cause damage or injury.

Safety first! Always treat your C2 ECD as if it were loaded.

- Never put your hands or other body parts in front of the ECD, especially when changing the cartridges.
  - Do not inadvertently point any cartridges at yourself or at anyone when loading.
  - Cartridge covers must be removed prior to attempting to load.
1. Point your C2 ECD in a safe direction; load the blue C2 simulation cartridge as described in the *Load the C2 Cartridges* section in this manual while keeping your fingers away from the blast doors.
  2. The cartridge can be set into the C2 ECD then locked into place by gently pushing the cartridge onto a firm, flat surface.
  3. Point your C2 ECD towards the training target and slide the safety cover back to activate the LASER and arm the ECD.
  4. Aim your C2 ECD at the training target; keep in mind that the LASER is within 2 to 3 inches (5 to 7.6 cm) of the point of impact for the top probe. Aim at the target's center of mass – to improve the accuracy of the bottom probe, avoid canting or tilting the ECD.
  5. Remember that the bottom probe comes out at an 8-degree downward angle. The bottom probe will drop 1 foot (0.3 m) below the top probe for every 7 feet (2.1 m) that it travels away from the ECD. Stand about 10 feet (3 m) from your target. This will result in a probe spread of about 18 inches (0.46 m). Place the LASER high enough on the target so the bottom probe will hit the target.
  6. Press the trigger button once to discharge the blue C2 simulation cartridge and activate the 30-second cycle. Remember that you can discontinue the discharge at any time by closing the safety cover.
  7. After the TASER discharge cycle ends, and the safety cover is closed, unload the expended blue C2 simulation cartridge as described in the *Unloading Cartridge* section of this manual.

## Aiming and Probe Placement for Self-Defense

Normally, aim the LASER at one of the large muscle groups (center of mass) such as the torso or thigh areas, etc.



**Avoid head, face, throat, or groin exposure unless your safety or the situation dictates otherwise.**

The top probe impacts the target near the LASER beam; however, the probe impact distance from the LASER beam will vary depending on the distance between the ECD and the target.

The bottom probe impacts at an 8-degree angle from the top probe. This results in a spread of approximately 1 foot (0.3 m) for every 7 feet (2.1 m) of distance from the target. Greater probe spread increases effectiveness. If possible, a minimum 4-inch (10 cm) spread between the probes is recommended.

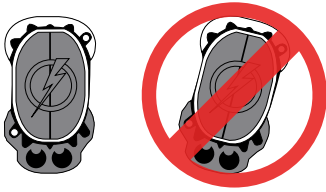

Do not tilt the ECD unless it is necessary to do so to align the ECD with the target.

Be sure not to fire at a subject who is over 15 feet or 4.6 meters away (measure 15 feet or 4.6 meters to see how far this is – it will probably be further than you think). If you do deploy at someone more than 15 feet or 4.6 meters away, the probes will not have sufficient wire to reach the target.

If the subject is on the ground and there are no other attackers, place the C2 ECD on the ground (don't drop it as the impact could damage the unit) and quickly leave the area. Do not attempt to retrieve the ECD. TASER International will replace the C2 ECD for free upon receipt of a police report (U.S. only).

## Using the C2 ECD

The C2 ECD is a serious, state-of-the-art defensive weapon and should be treated accordingly. Although the ECD is designed to be as nonviolent as possible in stopping a combatant, its use can result in injuries, including but not limited to, a probe embedded in an eye or secondary injuries related to falling. For a full list of warnings, see the *Warnings* section of this manual or [www.TASER.com](http://www.TASER.com).

The TASER ECD is to be used only for lawful purposes, including lawful self-defense or in the defense of others. Check your state and local laws for applicable regulations.

Depending on local and state laws, the C2 ECD may be kept in the house for home protection, or carried in a car, purse, or backpack for personal protection when away from home. Be sure to research each state's applicable laws prior to possessing or transporting the ECD including the transporting of the ECD across state lines and into other states where laws may vary. For a list of known laws related to ECDs, go to [www.TASER.com](http://www.TASER.com).

An ECD is not a substitute for other preventive self-protection actions such as ensuring doors are locked, and parking in well-lighted areas.

## Deployment Instructions for Self-Defense



**DO NOT use simulation (blue) cartridges for self-defense. A simulation cartridge will have no NMI effect on an attacker. For more information, see the *TASER C2 Simulation Cartridges* section in this manual.**

1. Remove the C2 ECD from its holster and ensure that the C2 cartridge is installed.
2. If a subject approaches in a suspicious or threatening manner, place the safety cover in the open (ARMED) position.
3. Aim the LASER beam at the center of the attacker's torso, or at the attacker's legs.
4. Shout verbal commands to "get away," if feasible. It is possible that the subject will flee based on the noise and LASER.
5. If the subject gets within 15 feet and you have reason to fear for your safety, deploy the C2 ECD.
6. Set the C2 ECD down and immediately seek safety. This may include re-entering a safe building, entering your car and driving away, etc.
7. As soon as it is safe to do so, call 911 and report the specific location of the threat.
8. Do not hesitate to place the C2 ECD on the ground and leave it at the scene of the attempted assault. Remember, it is important that you get to safety quickly. Send a copy of the police report to TASER International and we will replace the ECD at no charge. See [www.TASER.com](http://www.TASER.com) for more information on the replacement guarantee. (The replacement guarantee is available in the U.S. only.)

## What if I Miss?

The LASER sight is an extremely valuable aid for proper aiming. However, there is always the chance for a missed shot, especially in a dynamic, stressful situation, and you must be prepared to take alternative actions to protect yourself in case of a missed shot or reduced effectiveness. In the event that you shoot and miss, you can also use your C2 ECD as a direct contact stun device which is designed for pain compliance.

## "Silence is Golden"

The TASER ECD's electrical current is relatively quiet in actual human use. Therefore, the ECD may make very little sound when the probes are successfully deployed on a human target. In contrast, some practice conductive targets produce a loud sound when used because the energy is arcing in the air.

If the electrical current is loud during the ECD's use on a human target, and the subject is not reacting as expected, the current may be shorting out and may not be effective. Deploy a second cartridge or consider other options in that situation.

## Potential Causes of Reduced or No Effectiveness

- **Loose or Thick Clothing.** The current from the C2 ECD is capable of penetrating approximately 2 cumulative inches (5 cm) of clothing, or approximately 1 inch (2.5 cm) of clothing per probe.
- **Miss or Single Probe Hit.** The current must pass between the 2 probes. If 1 probe misses, a second cartridge should be deployed if practical. Also, using the C2 ECD in the drive-stun mode as described below can also complete the circuit between the single probe and the ECD electrode.
- **Low Nerve or Muscle Mass.** If the probes impact in an area where there is very little muscle mass (e.g., the side of the rib cage), the effectiveness can be significantly diminished.
- **Limited Probe Spread.** Probe spreads of less than 4 inches/10 cm (including drive-stun) result in little or no effect from NMI and become primarily a pain compliance option. If a close range deployment resulting in limited probe spread does not incapacitate the subject, apply a drive-stun, as described below, to a point away from the probes. This will effectively widen the contact area and can achieve NMI.

- **Wires Break.** If a wire breaks (e.g., during a struggle), the current will not flow to the probes. Drive-stun is still available.

## Drive-Stun Backup

Drive-stun capability is available with or without a C2 cartridge installed. The drive-stun mode will not cause NMI and generally becomes primarily a pain compliance option. Probe deployment is usually considered more desirable, even at close range. Some of the advantages of probe deployment include:

- Drive-stun is only effective while the ECD is in direct contact with the subject or when pushed against the subject's clothing. As soon as the ECD is moved away, the energy circuit with the target breaks. Deploying the probes allows the user to create distance between the user and the subject while maintaining control.
- Due to automatic reflex actions, most subjects will struggle to separate from the ECD. When the ECD is used in the drive-stun mode and the subject struggles to get away it may be difficult to maintain contact between the ECD and the subject.
- If the probes are deployed, even at very close range, the user may be able to use a drive-stun to another portion of the body that is farther away from the probes, thereby increasing the chance of NMI.

When using the drive-stun, push (drive) the front of the ECD firmly against the body of the subject. Simply "touching" the C2 ECD against the subject is not sufficient. The subject is likely to recoil and try to get away from the stun electrodes. It is necessary to aggressively drive the front of the C2 ECD into the subject for maximum effect.

If the drive-stun is not effective, evaluate the location of the drive-stun and consider an additional cycle to a different pressure point.

## Recommended Drive-Stun Areas for Maximum Effect

Drive the C2 ECD into the following areas for maximum effectiveness.

- Carotid (sides of neck) (see warning below).
- Brachial plexus tie-in (upper chest).
- Radial (forearm).
- Pelvic triangle (see warning below).
- Outside of thigh.
- Tibialis (calf muscle).

If the probes are deployed, even at very close range, the user may be able to use a drive-stun to another portion of the body that is farther away from the probes, thereby increasing the chance of NMI.



**Use care when applying a drive-stun to the neck or groin. These areas are sensitive to mechanical injury (such as crushing to the trachea or testicles if applied forcefully). However, these areas have proven highly effective targets. These areas should only be targeted when citizens are defending themselves from violent attacks.**



## General Concepts

- The C2 ECD is a sensitive piece of electronic equipment, and should be handled with care. Avoid dropping a C2 ECD. Do not use a C2 ECD that has a cracked handle.
- Check the LPM battery pack regularly.
- Perform a spark test regularly.
- Check the expiration of the C2 cartridges (the 5-year expiration is listed on the base of the cartridge). Do not use an expired C2 cartridge.
- Secure the C2 ECD in a protective holster when not in use.
- Avoid exposing the C2 ECD to excessive moisture or water.
- See the troubleshooting guide at [www.TASER.com](http://www.TASER.com) for additional instructions.

## Changing the LPM Battery Pack

To install or change the LPM battery pack:

1. Place the safety cover in the closed (SAFE) position.
2. Remove the C2 cartridge.
3. To unload the LPM battery pack, depress the side buttons on both sides of the battery and remove the LPM battery pack from the handle of the C2 ECD.
4. Wait approximately 5 seconds; then install the new LPM battery pack. Ensure that the LPM battery pack is fully inserted into the C2 ECD. Failure to do so could result in a damaged ECD or a loss of power during a deployment.

## Dropped or Wet C2 ECD

If your C2 ECD is dropped or gets wet, follow these instructions.

1. Move the safety cover to the closed (SAFE) position.
2. Point the ECD in a safe direction and safely remove the cartridge.
3. Remove the LPM battery pack.
4. **CAUTION:** Dry the C2 ECD thoroughly (at least 24 hours). Do not use an external heat source such as a microwave oven or hair dryer to dry the C2 ECD.
5. Reinstall the LPM battery pack.
6. Point the ECD in a safe direction (away from your body or others).

7. Move the safety cover to the open (ARMED) position.
8. If the C2 ECD discharges without pressing the trigger button, move the safety cover to the closed (SAFE) position, remove the LPM battery pack, and do not use the ECD.
9. Spark test for a full 30 seconds.
10. If the C2 ECD does not function properly during the spark test, do not use the ECD.
11. If the spark test is normal, you may continue to use the C2 ECD.

# Additional Items

# 6

## Product Support

If you need product support on the C2 ECD, its accessories, or have any other questions, please contact customer service at:

U.S.: 1.888.827.3788

International: +1.888.827.3788



**If the TASER ECD has been exposed to bodily fluids or other biohazards, please contact the TASER customer service department at 1.800.978.2737 or 1.480.905.2000 for specific instructions BEFORE returning the ECD to TASER International.**

## Additional Information

New TASER-brand products are under development. Visit our website at [www.TASER.com](http://www.TASER.com) for the latest information on TASER products.

Material Safety Data Sheets (MSDS) for lithium batteries are available by contacting TASER international.

## Legality

The BATFE has classified our TASER M26-, X3-, X26- and C2-series ECDs as non-firearms because they use compressed gas, rather than explosives to launch the projectiles. Because M26-, X3-, X26-, and C2-series ECDs are not firearms, they may be carried without a permit in certain jurisdictions (check state and local laws for permit requirements in your area). Currently the TASER ECD is restricted from possession by citizen users in the following states: Hawaii, Massachusetts, Michigan, New Jersey, New York, Rhode Island, Wisconsin, Washington DC, U.S. Virgin Islands, and certain cities and counties. Check our website at [www.TASER.com](http://www.TASER.com) for a list of known state and local laws concerning TASER ECDs. Because state and local laws may change, be sure to research the applicable laws in your area prior to using, possessing or transporting the ECD.

## Warranty

Any updates to the warranty policy can be found at [www.TASER.com](http://www.TASER.com). Below is the Warranty effective as of October 22, 2010:

The following TASER International, Inc. ("TASER International") warranty provisions are applicable on all sales or transfers of TASER International Citizen Products, including electronic control devices (ECDs).

The term "Purchase" means any purchaser, transferee, possessor, or user of the TASER International Citizen Products.

## Manufacturer's Limited Warranty

TASER International warrants that its TASER® X26C™ ECD, M26C™ ECD, and ECD cartridges are free from defects in workmanship and materials for a period of ONE (1) YEAR from the date of receipt. TASER International warrants that its C2™ ECD is free from defects in workmanship and materials for a period of 90 DAYS from the date of activation. ECD cartridges that are expended are deemed to have operated properly. TASER-manufactured accessories, including, but not limited to: batteries; battery chargers; carrying cases; cables; holsters; DPM™, and XDPM™ are covered under a limited 90-DAY warranty from the date of receipt. TASER International warrants that the C2 ECD's MP3 Holster is free from defects in workmanship and materials for a period of 30 DAYS from the date of receipt. The Non-TASER manufactured accessories are covered under their manufacturers' warranty and not TASER's warranty. In the event any country or state imposes a longer express warranty term than that described in this warranty document, then the country or state's term will take precedence.

If a defect arises and a valid claim is received by TASER International within the limited warranty period, TASER International agrees to repair or replace a defective product which, under normal use, as defined in the written and/or video instructions that accompanied the product at time of purchase, and as determined in TASER International's sole discretion, fails to function within the limited warranty period. TASER International's sole responsibility under this limited warranty is to repair or replace with the same product or a like product, at TASER International's option, for a product determined to be defective by TASER International. TASER International will undertake the repair, replacement, or refund 1 time during the limited warranty period. After the limited warranty period, TASER International will repair or replace a defective X26C or M26C ECD for a fee as specified on TASER International's website ([www.TASER.com](http://www.TASER.com)). A replacement product assumes the remaining warranty of the original product or 90 days from the date of replacement or repair, whichever provides longer coverage to the Purchaser. When a product or part is exchanged, any replacement item becomes Purchaser's property and the replaced item becomes TASER International's property.

## Lifetime Replacement Guarantee

When an X26C, M26C, or C2 ECD is used in self-defense, the ECDs may be deployed and left behind providing the Purchaser a window of opportunity to get to safety and call law enforcement. TASER International will replace the TASER X26C, M26C, or C2 ECD free of charge, with the same product or a like product, at TASER International's option, if the Purchaser provides, within one year following the event, the following information to TASER International, 17800 North 85th Street, Scottsdale, Arizona 85255 Attn: Customer Service:

- a copy of the official police report documenting the incident and the loss of the product;
- proof of purchase of the product (receipt, purchase order, or invoice);
- check or a credit authorization for the shipping and handling fees; and
- purchaser's name, physical address (no PO Boxes allowed), and phone number of where to send the replaced item.

Purchaser is responsible for any expedited shipping or handling costs for the replacement ECD. Purchaser is responsible for any activation costs of the replacement product. A replacement product assumes the remaining warranty of the original product or 90 days from the date of replacement, whichever provides longer coverage to the Purchaser.

<sup>1</sup>Please be aware that a product's expiration date may not be the product's warranty expiration date.

TASER International's Lifetime Replacement Guarantee is not available or applicable: (a) on any international (Non-United States) sales or uses of TASER Citizen Products; or (b) to any Purchaser who uses the ECD for a commercial purpose.

## Optional Extended Warranty for X26C and M26C ECD and Manufacturer's Extended Warranty for the C2 ECD

The optional extended warranty for an X26C and M26C ECD may only be purchased during the 1 year limited warranty period. The optional manufacturer's extended warranty for the C2 ECD may be purchased anytime during the 90-day limited warranty period. The extended warranty for an X26C or M26C ECD runs from the date of receipt of the extended warranty through the balance of the 1-year limited warranty plus the term of the extended warranty measured after the expiration of the 1-year limited warranty. The manufacturer's extended warranty for the C2 ECD runs from the date of receipt of the manufacturer's extended warranty and supersedes the 90-day limited warranty. The extended warranty does not cover abuse, intentional or deliberate damage to the product, acts of God, or force majeure during the extended warranty period.

For customers who purchase an extended warranty, TASER International warrants it will repair or replace the TASER ECD, which fails to function for any reason, not excluded by this extended warranty, 1 time during the extended warranty period with the same product or a like product. For the X26C and M26C ECDs, the replacement unit will have a 1-year limited warranty beginning on the date of receipt by Purchaser of the replacement unit. For the C2 ECD, the replacement unit will have a 90-day limited warranty beginning on the date of receipt of the replacement unit. Purchaser has the option of buying a new optional extended warranty for the C2 ECD replacement unit at the time of activation or anytime during the 90 day limited warranty. Purchaser has the option of buying a new optional extended warranty for the X26C or M26C ECD replacement unit during the replacement unit's limited warranty period. When a product or part is exchanged, any replacement item becomes Purchaser's property and the replaced item becomes TASER International's property.

## Exclusions and Limitations

This warranty supersedes any prior, contrary, or additional representations, whether written or oral. This warranty is TASER International's only warranty and may not be changed or enlarged by any agent, employee, distributor, dealer, or other person.

This warranty does not apply and TASER International will not be responsible for any loss, damage, or other liabilities arising from: (a) damage from failure to follow instructions relating to the product's use; (b) damage caused by use with non-TASER International products or from the use of cartridges, batteries (and cells) or other parts, components or accessories that are not manufactured or recommended by TASER International; (c) damage caused by accident, abuse, misuse, force majeure, acts of God, flood, fire, earthquake or other external causes; (d) damage to a product or part that has been repaired or modified to alter functionality, or capability by persons other than TASER International authorized personnel and without the written permission of TASER International; or (e) if any TASER International serial number has been removed or defaced.

To the extent permitted by law, this warranty and the remedies set forth above are exclusive and in lieu of all other warranties, remedies, and conditions, whether oral or written, statutory, express or implied, as permitted by applicable law, TASER International specifically disclaims any and all statutory or implied warranties, including without limitation, warranties of merchantability, design, fitness for a particular purpose, arising from a course of dealing, usage or trade practice, warranties against hidden or latent defects, and warranties against patent infringement. If TASER International cannot lawfully disclaim statutory or implied warranties than to the extent permitted

by law, all such warranties are limited to the duration of the express warranty described above and limited to the other provisions contained in this warranty document.

The remedies provided for in the above warranty are expressly in lieu of any other liability TASER International may have. TASER International's cumulative liability to any party for any loss or damage resulting from any claims, demands, or actions arising out of or relating to any TASER product will not exceed the purchase price paid to TASER International by Purchaser for the product, notwithstanding third-party purchases. In no event will TASER International be liable for any direct, special, indirect, incidental, exemplary, punitive or consequential damages, however caused, whether for breach of warranty, breach of contract, negligence, strict liability, tort or under any other legal theory, even if TASER international has been advised of the possibility of those damages or if those damages could have been reasonably foreseen, and notwithstanding any failure of essential purpose of any exclusive remedy provided in this warranty. Some local laws do not allow for the limitation or exclusion of liability for incidental or consequential damages, so the above limitation or exclusion may not apply to you. TASER International disclaims any representation that it will be able to repair any product under this warranty or make a product exchange without risk to or loss of programs or data.

If any term of this warranty is held to be illegal or unenforceable, the legality of the remaining terms will not be affected or impaired.

## Release

Purchaser agrees to release and save TASER International harmless from any and all liability arising out of the deployment, use or misuse of the TASER product, including any claims for damages and personal injuries. Purchaser agrees to assume all risks of loss and all liability for any damages and personal injury which may result from the deployment, use or misuse of the TASER product. TASER International is not liable for the failure of the TASER product to perform and TASER International is not liable for any claims made by a third party or by Purchaser for or on behalf of a third party.

## Warranty Repair Procedure

Please access and review the online troubleshooting guide on TASER International's website ([www.TASER.com/support](http://www.TASER.com/support)) before seeking warranty service. If the product is still not functioning properly after making use of this resource, please follow the warranty repair procedure outlined in this policy. You must follow TASER International's warranty processes. To make a warranty claim, first verify that your TASER product is within its active warranty period.

To register a warranty claim, first obtain a Return Material Authorization ("RMA") number within the warranty period from TASER International through TASER International's website ([www.TASER.com/support](http://www.TASER.com/support)). If internet access is not available, then contact TASER International by mail or toll-free telephone number at 800-978-2737. TASER International will advise what parts need to be returned for repairs or replacement.

Purchaser is responsible for returning the defective product to: TASER International, Inc., 17800 North 85th Street, Scottsdale, Arizona 85255 Attn: RMA Department; via prepaid postage by the Purchaser. For Purchasers outside the United States, and in order to comply with U.S. government export restrictions, Purchaser is responsible for returning the defective product to the TASER International authorized distributor in the country where the product was purchased and the authorized distributor will then return the product to TASER International or replace the product.

Purchaser must provide the following with the returned product in order to receive a 7–10 day

processing time from the date of receipt of the returned product by TASER International:

- RMA number on the outside of the package;
- Written information as to the nature of the defect;
- Proof of purchase of the product (receipt, purchase order, or invoice);
- Proof of purchase of an extended warranty, if applicable (receipt, purchase order, or invoice);
- Check or a credit authorization for the replacement fee specified on the TASER International website, if applicable; and
- Name, physical address (no PO Boxes), and phone number of where to return the repaired or replaced item.

**Failure to provide the required information will delay the return of the repaired or replaced item for 12 weeks or more. If Purchaser fails to provide the required information, including the RMA number, then TASER International assumes no liability for loss of the returned product. Any TASER product that has not been paid for or for which the required information has not been provided during a period of 90 days after receipt of the TASER product by TASER International is deemed abandoned and TASER International may dispose of the TASER product without any compensation or further notification to Purchaser.**



**TASER**

C2, Check Lock, DPM, EPM, LPM, M26C, Shaped Pulse, TASER CAM, XDPM, X3C, X26C 'Protect Life' and  are trademarks of TASER International, Inc., and TASER® is a registered trademark of TASER International, Inc., registered in the U.S. All rights reserved. © 2007-2010 TASER International, Inc.