

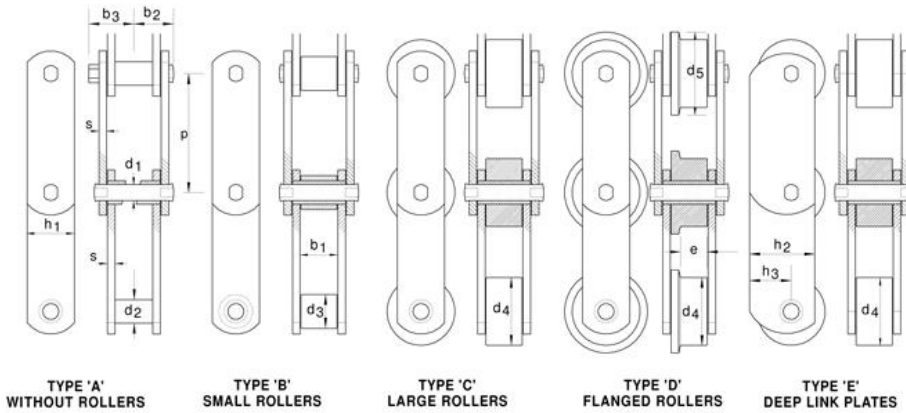

CONVEYOR CHAIN M112

M112 series Conveyor chains manufactured to DIN 8167 ISO 1977 available in deep links and rollers and Plain Bush Construction, 112KN breaking strength conveyor chain.



FB Kedjor Ref	FB Letchworth Ref	Pitch p	Inside Width b ₁	Pin Dia d ₁	Bush Dia d ₂	Roller Dia d ₃	Roller Dia d ₄	Flange Dia d ₅	Plate Thick s	Plate Height					Chain Weight kg/m
								e		h ₁	h ₂	h ₃	b ₂	b ₃	

3831	M112A080	80	32	15	21				6	40			33	37	7.4
3832	M112B080	80	32	15		30			6	40			33	37	8.3
3833	M112C080	80	32	15			60		6	40			33	37	
3834	M112D080	80	32	15			60	70	22	6	40		33	37	
3835	M112E080	80	32	15			60		6		60	40	33	37	

3841	M112A100	100	32	15	21				6	40			33	37	6.7
3842	M112B100	100	32	15		30			6	40			33	37	7.4
3843	M112C100	100	32	15			60		6	40			33	37	11.9
3844	M112D100	100	32	15			60	70	22	6	40		33	37	12.8
3845	M112E100	100	32	15			60		6		60	40	33	37	13.8

3851	M112A125	125	32	15	21				6	40			33	37	6.1
3852	M112B125	125	32	15		30			6	40			33	37	6.7
3853	M112C125	125	32	15			60		6	40			33	37	10.3
3854	M112D125	125	32	15			60	70	22	6	40		33	37	11.0
3855	M112E125	125	32	15			60		6		60	40	33	37	12.2

3861	M112A160	160	32	15	21				6	40			33	37	5.6
3862	M112B160	160	32	15		30			6	40			33	37	6.0
3863	M112C160	160	32	15			60		6	40			33	37	8.9
3864	M112D160	160	32	15			60	70	22	6	40		33	37	9.4
3865	M112E160	160	32	15			60		6		60	40	33	37	10.7