

Connection details & information shown on this drawing are for approval of positions only. Connections are not included unless they are specifically detailed on your order and our final agreed quotation.

Copyright in all design and detail is reserved by Dutypoint Systems and these drawings must not be reproduced without written permission.

Tank Foundations

BS EN 13280:2001 (E) ANNEX M.2

The top surface of the foundation, whether it is flat screed concrete, steelwork, support walls or pillars, should be flat, level and free from any local irregularities. It should not vary more than 2mm in any 1m, or a total of 6mm in any 6m, measured laterally or diagonally. Intermittent supports should be spaced in accordance with the manufacturer's instructions and should be continuous in one direction.

If foundations are to be provided by suspended floors or beams, then the foundation should be constructed so that when the tank is full, the combined deflections should not exceed 1/500th of the span.

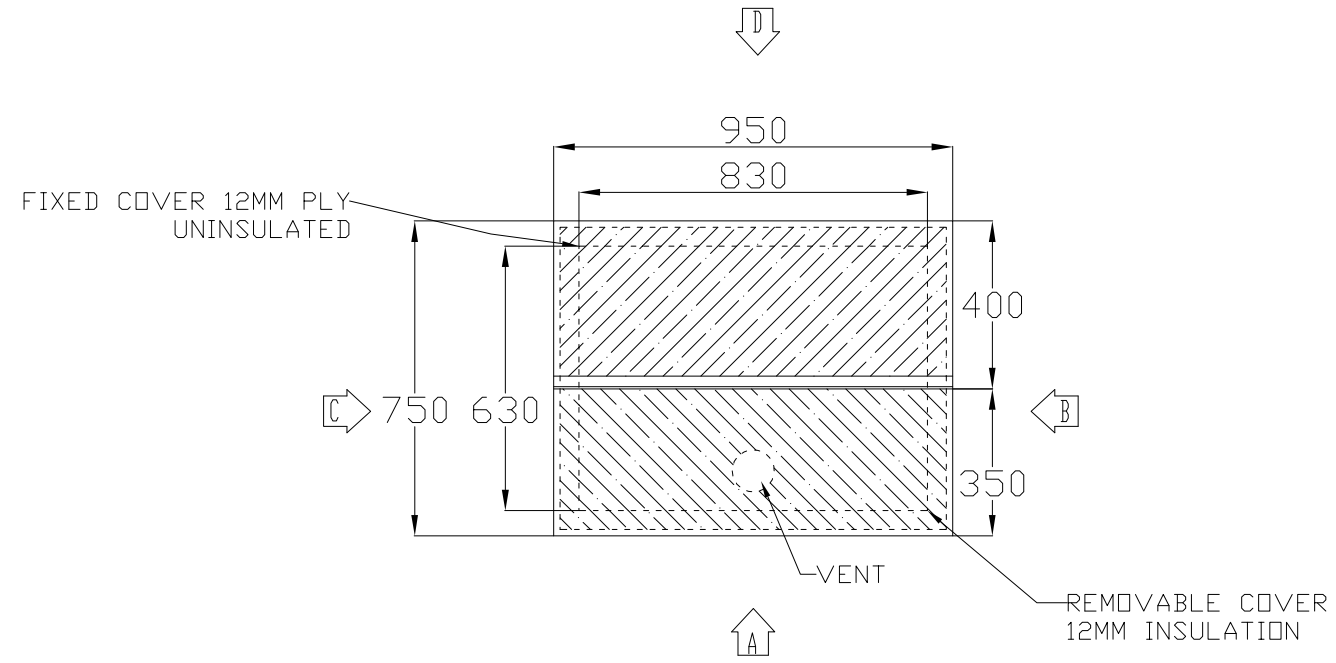

connection details

- 1 - 3/4" ball valve, by others 150mm cutout
- 2 - 1.5" pushfit overflow 150mm cutout
- 3 - spare 150mm cutout

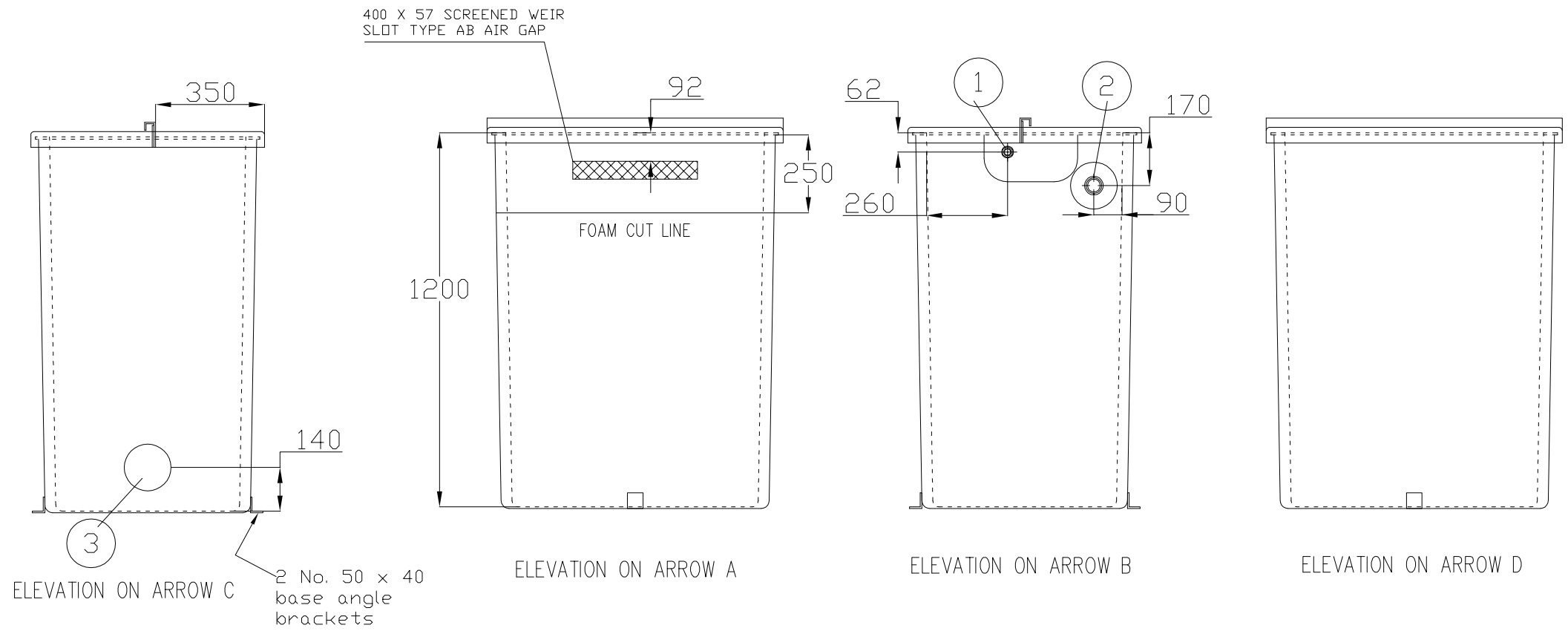

W/D No -

TITLE
G/A OF 830 X 630 X 1200 GRP ONE PIECE SPECIAL TANK

DRN JPC DATE 06/11/2012

SCALE 1:18 DRG No DPT5052

FOR : DUTYPOINT SYSTEMS

PROJECT : SCUBA 490