



## **USER'S MANUAL**

---

**COGENTIX MEDICAL**

**Flexible Video Nasopharyngo-Laryngoscope**

**ENT-5000/ENT-7000**

*and Slide-On<sup>®</sup> EndoSheath<sup>®</sup> Technology*

---

**NOTE: Federal (USA) law restricts this device to sale by, or on the order of, a physician or other appropriately licensed medical professional.**

***[www.cogentixmedical.com](http://www.cogentixmedical.com)***

---

© 2008, 2009, 2010, 2012, 2013, 2014, 2015 Cogentix Medical, Inc. All rights reserved. Printed in the United States of America.

The information contained herein is the exclusive and confidential property of Cogentix Medical, Inc. No part of this manual may be disclosed or reproduced in whole or in part without permission from Cogentix Medical, Inc.

---

# How to Use This Manual

This User's Manual contains the recommended procedures for preparing and using the Cogentix Medical **ENT-5000/ENT-7000** Flexible Video Nasopharyngo-Laryngoscope. It is intended for physicians and other medical personnel who will come in contact with the endoscope before, during, and after any patient procedures performed with them. The manual also contains pertinent information on the proper care and handling of the equipment. Please read and become familiar with this entire manual before using the endoscope.

This manual contains the following information:

- Description of the endoscope
- The endoscope's intended use
- Components and features of the endoscope and peripheral equipment used in conjunction with the endoscope
- Complete instructions on endoscope preparation, inspection, operation, reprocessing, and storage
- Warning and Caution statements that must be observed by endoscope users to ensure patient and user safety

If you are a **first time endoscope user**, Cogentix Medical strongly recommends that you read this manual from beginning to end and become intimately familiar with the endoscope and its use.

If you are an **experienced endoscope user**, select specific chapters and/or sections that pertain to features and procedures that you are using.

---

## Organization of this Manual

Following is a list of the chapters included in this User's Manual. Each chapter's title is listed at the top of all pages after the title page, so that you can quickly access the information you need.

**Chapter 1, Symbols and Terms** – This chapter defines the symbols on the endoscope and peripheral equipment. There is also a brief list of the terms that are commonly used in the manual.

**Chapter 2, Important Information** – The information in this chapter is a summary of critical Warning and Caution statements in the manual. This information is essential to the safe operation and reprocessing of the endoscope. Cogentix Medical, Inc. strongly recommends that this chapter be read thoroughly and completely understood by all users before working with the endoscope.

**Chapter 3, Endoscope and Accessories** – Introduces the **ENT-5000/ENT-7000** Flexible Video Nasopharyngo-Laryngoscope and compatible peripheral equipment. This chapter includes instrument diagrams, identifies components, and defines their functions.

## How to Use This Manual

**Chapter 4, Preparation, Inspection and Operation** – This chapter describes how to prepare the endoscope and peripheral equipment for use, and how to assemble the equipment into a system. The chapter also leads you through a detailed inspection procedure to confirm that the equipment is undamaged and working properly before it is used in a procedure.

**Chapter 5, Reprocessing** – This chapter contains important instructions on the proper cleaning, disinfection, and sterilization of the endoscope before its first use and after each subsequent use. Strict adherence to the instructions in this chapter will render the endoscope “patient-ready” for each procedure.

**Chapter 6, Care and Storage** – If the endoscope will not be used for a prolonged period, refer to this chapter for instructions on safe, secure storage.

**Chapter 7, Troubleshooting** – Describes possible problems that may be encountered with the endoscopic system, and suggests corrective actions to take towards resolving minor problems.

**Chapter 8, Warranty and Service** – This chapter contains the terms of the Cogentix Medical warranty on the endoscope, any restrictions that apply and user actions that may void the warranty if taken. This chapter also includes shipping instructions in case the endoscope must be returned to Cogentix Medical or a regional distributor for repair.

The **Appendix** contains the technical specifications for the **ENT-5000/ENT-7000** Flexible Video Nasopharyngo-Laryngoscopes and infection control information.

---

## Additional Information

The information in this User’s Manual is subject to change without notice. If you have any questions regarding any of the material contained in this manual, or wish to confirm that this is the most-comprehensive information available for this product, please contact your local distributor or Cogentix Medical Customer Service Department at (866) 258-2182 or (+1) 952 426-6189 (International).

# Table of Contents

<b>How to Use This Manual</b> .....	<b>i</b>
Organization of this Manual .....	i
Additional Information .....	ii
<b>1 Symbols and Terms</b> .....	<b>1</b>
Symbols.....	1
Terms.....	2
<b>2 Important Information</b> .....	<b>3</b>
Intended Use .....	3
User Qualifications.....	3
Reprocessing.....	3
Maintenance and Repair.....	4
Signal Words.....	4
Important Safety Precautions .....	4
Preparation, Inspection, and Assembly.....	4
During Use .....	5
Reprocessing .....	6
<b>3 Endoscope and Accessories</b> .....	<b>7</b>
Inspect the Standard Set.....	7
Equipment Diagrams.....	8
ENT-5000/ENT-7000 Flexible Video Nasopharyngo-Laryngoscope.....	8
DPU-5000/7000 Series Digital Video Processor.....	10
The Slide-On® EndoSheath® Technology .....	11
Accessories .....	11
Video Processor .....	11
Light Sources.....	11
Leak Testing .....	12
Reprocessing .....	12
<b>4 Preparation, Inspection and Operation</b> .....	<b>13</b>
Preparation and Inspection.....	14
Select an Installation Site.....	14
Endoscope Operation .....	15
<b>5 Reprocessing</b> .....	<b>17</b>
Reprocessing Steps.....	18

## Table of Contents

Leak Testing.....	18
Attach the Leak Tester to the Endoscope.....	19
Pressurize the Endoscope.....	19
Cleaning, Disinfection, and Sterilization.....	21
Use of the Vent Cap.....	21
Cleaning After Slide-On® EndoSheath® Technology Use.....	21
High-Level Disinfection and Sterilization.....	22
Recommended Disinfection and Sterilization Procedures .....	22
Incompatible Methods.....	23
High-Level Disinfection Protocol .....	24
Pre-Cleaning .....	24
Disinfection.....	24
Rinsing .....	24
Ethylene Oxide (EtO) Gas Sterilization .....	25
EtO Gas Sterilization Parameters.....	25
After EtO Gas Sterilization .....	25
STERRAD® and STERIS® Sterilization .....	26
<b>6 Care and Storage.....</b>	<b>27</b>
Storage.....	27
Disposal.....	28
<b>7 Troubleshooting .....</b>	<b>29</b>
<b>8 Warranty and Service.....</b>	<b>33</b>
Warranty Information.....	33
Cogentix Medical Service Information .....	33
Shipping to Cogentix Medical or Distributor .....	34
<b>Appendix .....</b>	<b>35</b>
Specifications .....	35
Electromagnetic Compatibility Declarations .....	36

---

## **Index of Figures**

Figure 3-1: ENT-5000/ENT-7000 Flexible Video Nasopharyngo-Laryngoscope.....	8
Figure 3-2: ENT-5000/ENT-7000 Flexible Video Nasopharyngo-Laryngoscope–Control Body .....	9
Figure 3-3: DPU-5000/7000 Series Digital Video Processor .....	10
Figure 5-1: Leak Tester Connection .....	19
Figure 5-2: Opening the Vent Valve .....	21

---

## **Index of Tables**

Table 3-1: ENT-5000/ENT-7000 Flexible Video Nasopharyngo-Laryngoscope Standard Set .....	7
Table 5-1: STERRAD® and STERIS® Validated Systems/Cycles .....	26
Table 7-1: Troubleshooting .....	30
Table A-1: Specifications .....	35
Table A-2: Electromagnetic Emissions Declaration.....	36
Table A-3: Electromagnetic Immunity Declaration .....	37
Table A-4: Electromagnetic Immunity Declaration .....	38
Table A-5: Recommended Separation Distances .....	39





# 1 Symbols and Terms

---

## Symbols

The symbols listed below can be found on the **ENT-5000/ENT-7000** Flexible Video Nasopharyngo-Laryngoscope and on other components of the endoscopic system.



Type BF applied part (Safety degree specified by IEC 60601-1)



Alerts the user to the presence of important operating, maintenance, and service instructions. Refer to the user's manuals for warnings and safety precautions associated with equipment used in the procedure.



Endoscopes bearing this mark indicate compliance with all applicable European Union (EU) regulations and recommendations.



Serial number of the endoscope



Up position for the Angulation Lever



Down position for the Angulation Lever



STERIS<sup>®</sup> and STERRAD<sup>®</sup> Reprocessing Compatibility  
Refer to Chapter 5, Reprocessing (Endoscope must feature the  symbol for STERIS<sup>®</sup> / STERRAD<sup>®</sup> compatibility)



Products do not contain natural rubber latex



Consult Instructions for Use



The presence of this symbol on the product or packaging indicates that the device is RoHS compliant.

---

### Terms

The following terms are used throughout this User's Manual:

**"Laryngoscope", "Endoscope", "Videoscope", or "ENT Scope"** refers to the Cogentix Medical **ENT-5000/ENT-7000** Flexible Video Nasopharyngo-Laryngoscope.

**"Slide-On<sup>®</sup> EndoSheath<sup>®</sup> Technology" or "Sheath"** refers to the disposable **Slide-On<sup>®</sup> EndoSheath<sup>®</sup> Technology** for the **ENT-5000/ENT-7000** Flexible Video Nasopharyngo-Laryngoscope.

**"Processor"** refers to the **DPU-5000/7000 Series** Video Processors.

# 2 Important Information

The information in this chapter is essential for the correct and safe operation of the **ENT-5000/ENT-7000** Flexible Video Nasopharyngo-Laryngoscope. Please read and understand this information before preparing or using the endoscope or any peripheral equipment with which it will be used.

---

## Intended Use

The Cogentix Medical **ENT-5000/ENT-7000** Flexible Video Nasopharyngo-Laryngoscope is intended to be used for flexible endoscopic examination of the upper airway, vocal cords and/or nasal passages.

**Do not use the endoscope for any purpose other than these intended uses.**

---

## User Qualifications

The equipment should only be used in a medical facility by or under the supervision of a physician trained in laryngoscopy. Use of the system does not require any deviation from standard laryngoscopy technique. However, the operator should have complete familiarity with the operation of the entire system prior to clinical use.

Only use the endoscope and peripheral equipment according to the instructions and under the operating conditions described in this manual. Failure to do so could result in compromised safety, equipment malfunction and/or instrument damage.

For preparation of the device before use, and disassembly and proper cleaning after use, users should be adequately trained in the proper procedures. Failure to thoroughly understand these details, such as (but not limited to) **EndoSheath® Technology** installation and authorized disinfection protocols, may pose an infection control risk or cause equipment damage.

If training assistance is desired from either the manufacturer or a local distributor, please contact Cogentix Medical Customer Service at (866) 258-2182 or (+1) (952) 426-6189.

---

## Reprocessing

The endoscope must be thoroughly cleaned, disinfected, and/or sterilized before its first use and after each subsequent use. This is the only way to ensure that a "patient-ready" endoscope is used in every procedure. See Chapter 5, **Reprocessing**, for information on all reprocessing equipment and procedures.

### Maintenance and Repair

The endoscope contains **no** user-serviceable parts; **never** attempt to modify or repair it. Doing so may cause further equipment damage and/or compromise patient safety if the endoscope is subsequently used in a procedure. The endoscope may only be serviced / repaired at an authorized Cogentix Medical facility.

In addition to thoroughly inspecting the endoscope before each procedure, it should be periodically inspected to determine if there is damage or wear that requires attention.

### Signal Words

Information included in this manual to warn users of the possibility of patient injury and/or equipment damage is signified by the Warning and Caution symbols shown below. Warnings, Cautions and Notes will appear throughout this manual; carefully read and follow all statements.



Alerts the user to situations which, if not avoided, could result in death or serious injury.



Alerts the user to situations which, if not avoided, could result in moderate or minor injury to the user or patient. It is also used to alert the user to conditions and actions that could cause equipment damage.



**NOTE:** Indicates additional helpful information.

### Important Safety Precautions

The following precautions should always be exercised when using the endoscope and all medical equipment to ensure the safety of all involved parties – user(s), patient(s), etc. They are summarized here in the order of the stages of the endoscope's use.

#### Preparation, Inspection, and Assembly



Carefully inspect all equipment before using it in a procedure, and do not use any equipment that is damaged or excessively worn. Doing so could lead to patient injury and/or further damage to the equipment.

If inspection reveals difficulty in articulation of the endoscope's Distal Bending Section, the endoscope may be damaged. Do not use the endoscope if damage occurs; doing so could cause patient injury, and may result in further damage to the endoscope.

All devices that are connected to the **ENT-5000/ENT-7000** Flexible Video Nasopharyngo-Laryngoscope and **DPU-5000/7000 Series** Video Processors must be Classified Medical Equipment. Before using any additional equipment, confirm that it complies with the appropriate end-product safety standard (such as IEC 60950-1) and the Standards for Medical Electrical Equipment (UL 60601-1 or IEC 60601-1).

**CAUTION**

Never drop the equipment or subject it to severe impact, as it could compromise the functionality and/or safety of the equipment or system. Should the equipment be mishandled or dropped, do not use it. Immediately return it to an authorized Cogentix Medical service facility for inspection and repair.



**NOTE:** The Cogentix Medical **ENT-5000/ENT-7000** Flexible Video Nasopharyngo-Laryngoscopes and **Slide-On® Endo-Sheath® Technology** are not made with natural rubber latex.

**During Use**

**WARNING**

Do not use this equipment in the presence of a flammable anesthetic mixture containing air, oxygen or nitrous oxide. There is a possibility of fire or explosion.

If any of the components of the endoscopic system malfunction during the procedure, or if the endoscopic image is lost or compromised, immediately move the endoscope's Distal Bending Section into the neutral position and slowly withdraw the endoscope from the patient. Using an endoscope that is not functioning properly could cause patient injury and/or further damage to the equipment.

**CAUTION**

Always wear appropriate personal protective equipment when using the endoscope and/or sheath, such as a gown, gloves, and face and eye shields.

Avoid excessive bending or twisting of the endoscope's Insertion Tube and Videoscope Cable. Although they are designed to bend, excessive bending can damage the fiber bundles and internal components. Should the endoscope develop a severe kink or bend, do not attempt to straighten the insertion tube. Contact Cogentix Medical Customer Service for assistance.

**Do not** apply excessive pressure to the endoscope's Angulation Lever, as it could damage the endoscope and lead to patient injury.

**Do not** look directly at the intense light emitted from the endoscope tip to avoid the possibility of eye injury.

### Reprocessing

#### **WARNING**

The endoscope must be properly reprocessed, by cleaning, disinfecting and/or sterilizing, before its first use and after each subsequent use. Using an endoscope in a procedure that has not been properly reprocessed presents an acute infection-control risk to both the patient and medical personnel performing or assisting in the procedure.

#### **CAUTION**

Always wear appropriate personal protective equipment when reprocessing the endoscope, such as a gown, gloves, and face and eye shields.

Use extreme care when reprocessing the endoscope. Do not forcefully pull, push, or drag wipes, towels, or cloths along the Insertion Tube. The use of excessive force could damage the endoscope.

**Do not** immerse the endoscope in disinfectant solution for long periods of time (>1 hour). Prolonged immersions may damage the outer coverings of the endoscope and allow fluid infiltration.

**Do not** place the endoscope in or near contaminated areas after it has been reprocessed. Doing so can recontaminate the endoscope and require reprocessing to be repeated.

**Do not** place the endoscope in awkward or confining areas between procedures as this could result in equipment damage.

# 3 Endoscope and Accessories

The Cogentix Medical **ENT-5000/ENT-7000** Flexible Video Nasopharyngo-Laryngoscope has been designed for examination of the upper airway from the nasal passages to the vocal cords. With proper use, the endoscope provides a thorough examination for more accurate diagnoses with minimal patient discomfort.

The **ENT-5000/ENT-7000** Flexible Video Nasopharyngo-Laryngoscope is shown in Figures 3-1 and 3-2 on pages 8 and 9. The endoscope's Insertion Tube has no Working Channel; it contains the video camera module and illumination bundles.

## Inspect the Standard Set



Do not use any equipment that is observed to be damaged or excessively worn. Doing so could lead to patient injury and/or further damage to the equipment.

When the endoscope is received from Cogentix Medical, immediately confirm that all applicable items listed in Table 3-1 have been shipped, and inspect them for damage. If any item is missing or damaged, do not use the endoscope. Contact Cogentix Medical Customer Service to obtain a replacement part.

<b>ENT-5000/ENT-7000 NASOPHARYNGO-LARYNGOSCOPE STANDARD SET</b>	
<b>COGENTIX MEDICAL CATALOG NO.</b>	<b>DESCRIPTION</b>
02-5201	<b>ENT-5000</b> Flexible Video Nasopharyngo-Laryngoscope (NTSC)
02-5202	<b>ENT-5000</b> Flexible Video Nasopharyngo-Laryngoscope (PAL)
02-7201	<b>ENT-7000</b> Flexible Video Nasopharyngo-Laryngoscope (NTSC)
02-7202	<b>ENT-7000</b> Flexible Video Nasopharyngo-Laryngoscope (PAL)
07-6180	Cogentix Medical ENT-5000/ENT-7000 Carrying Case
07-6015	Vent Cap
	ENT-5000/ENT-7000 User's Manual (this document)
<b>VIDEO PROCESSORS (NOT SHIPPED WITH ENDOSCOPE)</b>	
07-5050	<b>DPU-5050</b> Video Processor with LCD Display*
07-5051	<b>DPU-5050A</b> Video Processor with Air Pump and LCD Display*
07-7001	<b>DPU-7000A</b> Video Processor with LCD Display
<b>OPTIONAL ITEMS/ACCESSORIES</b>	
07-6010	V1 Endoscope Leak Tester

**Table 3-1: ENT-5000/ENT-7000 Flexible Video Nasopharyngo-Laryngoscope Standard Set**

\*Available in select markets only

## Equipment Diagrams

### ENT-5000/ENT-7000 Flexible Video Nasopharyngo-Laryngoscope

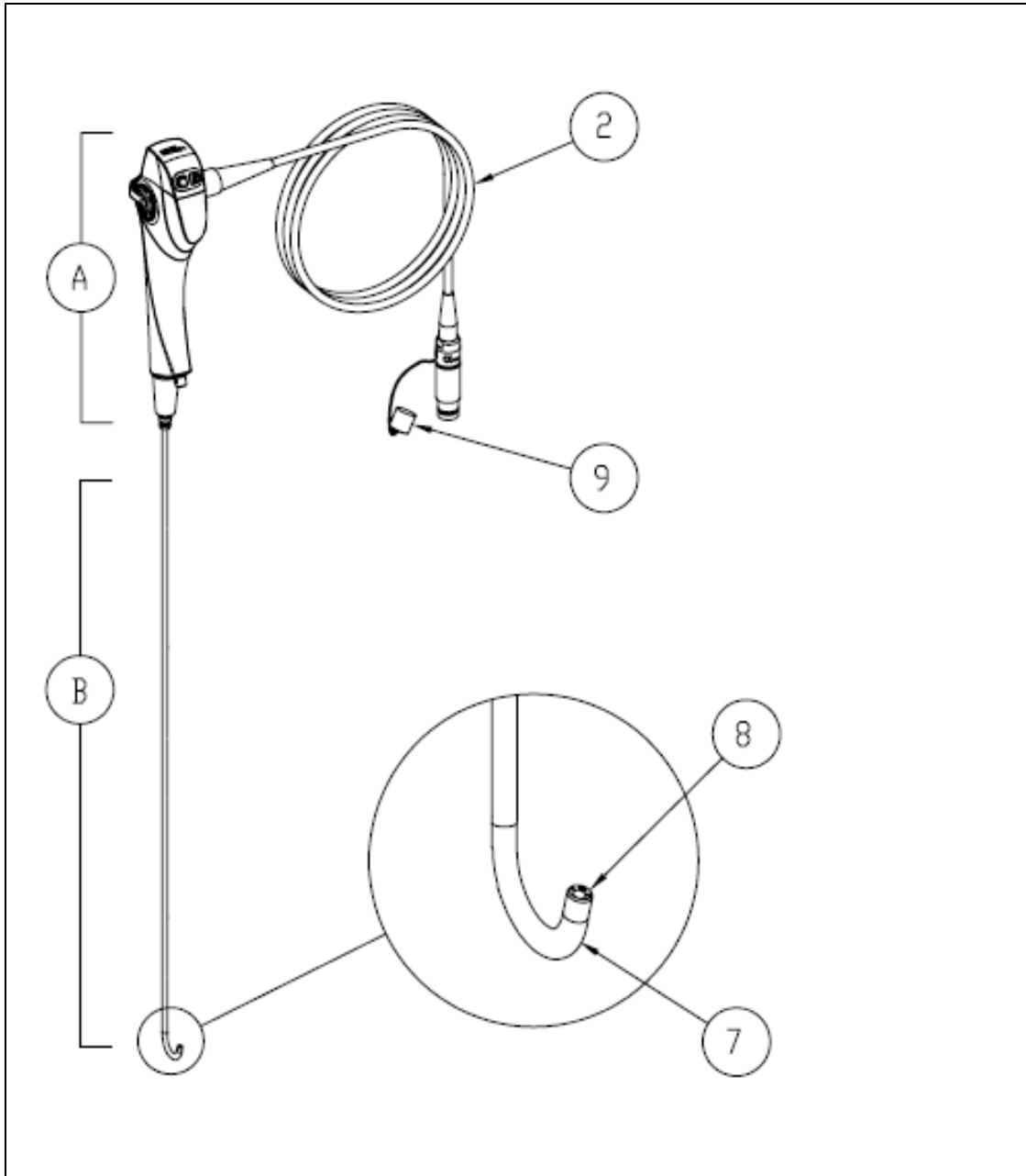

*Figure 3-1: ENT-5000/ENT-7000 Flexible Video Nasopharyngo-Laryngoscope*

- A. Control Body**
- B. Insertion Tube**



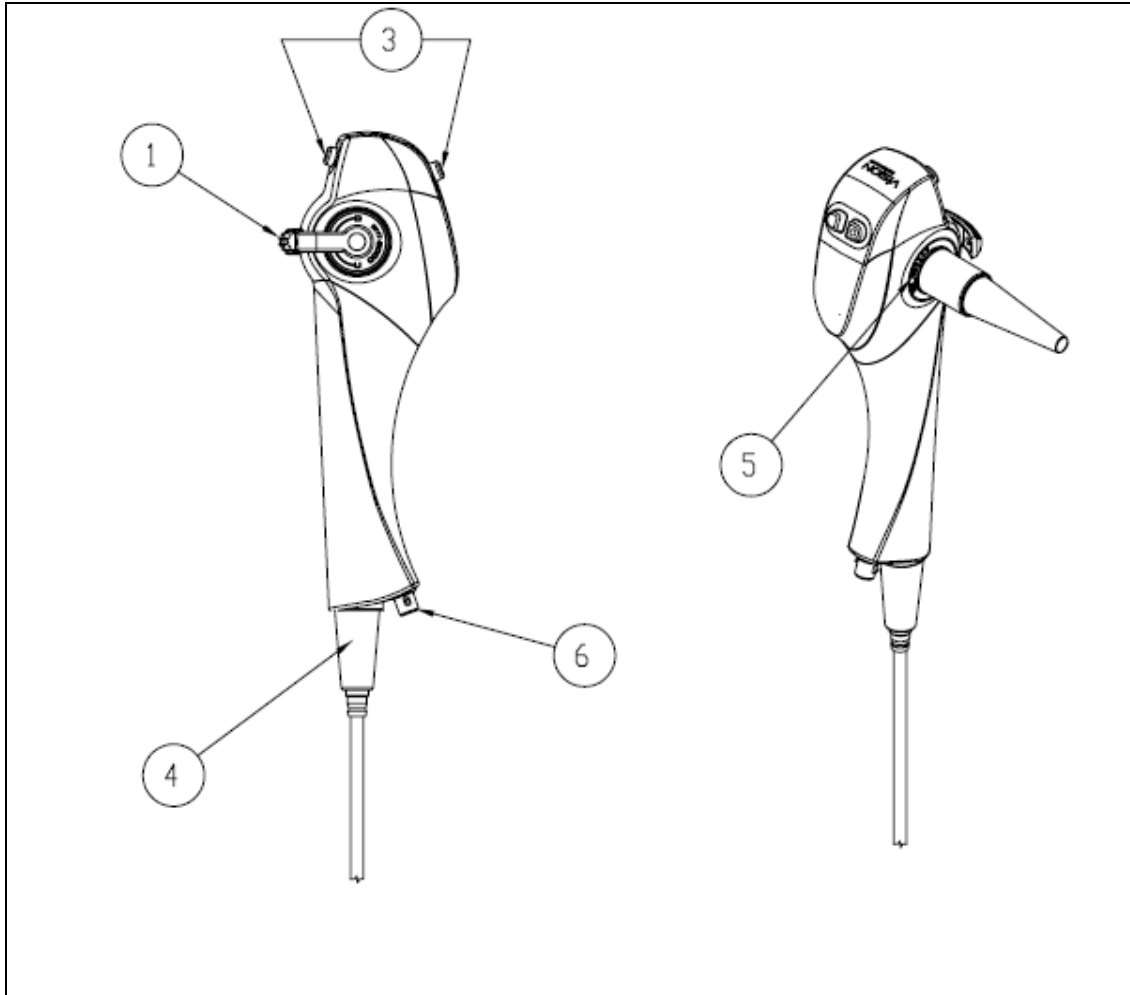

**Figure 3-2: ENT-5000/ENT-7000 Flexible Video Nasopharyngo-Laryngoscope – Control Body**

**Instrument Components**

1. **Angulation Lever:** Controls Distal Bending Section deflection.
2. **Videoscope Cable:** The connector (plug) at the end of the cable connects to the **DPU-5000/7000 Series** Digital Video Processor.
3. **Control Buttons:** Four programmable buttons allow the user to activate different functions of the video system. Consult the **DPU-5000/7000 Series** Video Processor User's Manual for instructions regarding the control functions and how to program the buttons.
4. **EndoSheath Interface:** Secures the disposable EndoSheath® cover to the endoscope body.
5. **Identification Ring:** Includes the Serial Number, which is a unique number identifying the endoscope; and the (S) symbol, indicating the endoscope can be sterilized using a validated STERRAD®/STERIS® system. The endoscope must feature this symbol on the Identification Ring in order for STERRAD®/STERIS® compatibility to apply.

## Endoscope and Accessories

6. **Vent Valve:** When the Vent Cap is connected, this Valve allows access to the interior of the endoscope for EtO and STERRAD<sup>®</sup> gas sterilization and should be connected during transport. The Vent Cap **must** be attached to the Valve prior to EtO or STERRAD<sup>®</sup> gas sterilization and prior to shipping. The Valve is also used as Leak Tester Connector for Leak Testing.
7. **Distal Bending Section:** Deflects up and down when the Angulation Lever is actuated.
8. **Distal Tip:** The terminating point of the video camera module and the light-guide fiber bundles [Light Guides].
9. **Sealing Cap:** This Videoscope Cable component seals the plug prior to soaking for leak testing or disinfection. This should also be kept closed when the cable is not in use and/or when the endoscope is being transported.

---

### DPU-5000/7000 Series Digital Video Processor

**CAUTION** The **ENT-5000/ENT-7000** Flexible Video Nasopharyngo-Laryngoscopes are not compatible with any other manufacturers' video processors. Attempting to connect the endoscope to or use it in conjunction with another manufacturer's video processor could cause damage to the endoscope and/or the video processor.

The **ENT-5000/ENT-7000** Flexible Video Nasopharyngo-Laryngoscopes **must** be used in conjunction with a **DPU-5000** or **DPU-7000 Series** Video Processor (Figure 3-3). Refer to the **DPU-5000/7000 Series** Video Processor User's Manual for complete instructions on the operation of the unit.

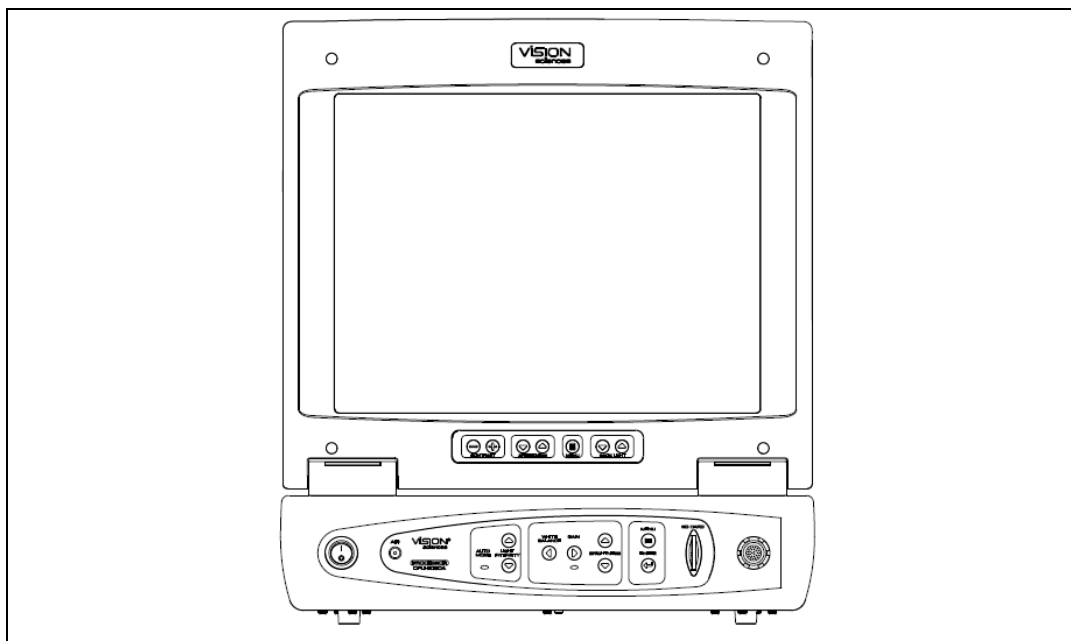

**Figure 3-3: DPU-5000/7000 Series Digital Video Processor**

---

## The Slide-On® EndoSheath® Technology

**WARNING**

Do not use the **Slide-On® EndoSheath® Technology** without first reviewing its Instructions-For-Use, which are shipped with each box of Sheaths.

Cogentix Medical recommends the use of the **Slide-On® EndoSheath® Technology** with the **ENT-5000/ENT-7000** Flexible Video Nasopharyngo-Laryngoscope. The **Slide-On® EndoSheath® Technology** is a sterile, disposable, protective covering which limits the need for elaborate chemical disinfection or sterilization procedures after every endoscopic procedure. The complete system enables the user to implement a fast and effective method of reprocessing an endoscope, and benefits both user and patient by providing an insertion tube covered with a sterile Sheath for every procedure. Contact your local distributor or Cogentix Medical Customer Service Center for information on ordering the **Slide-On® EndoSheath® Technology**.

Use of the **Slide-On® EndoSheath® Technology** does not require any deviation from standard nasopharyngoscopy technique; however, the physician should have complete familiarity with the operation of the system prior to clinical use.

---

## Accessories

**WARNING**

Do not use any accessories that are not in compliance with the equivalent safety requirements of this equipment. Doing so may reduce the operational safety of the system and could cause patient and/or user injury. For all accessories, confirm the safety certifications have been performed in accordance with the appropriate standard (IEC 60601-1 and/or IEC 60601-1-1).

The use of accessories not specified in this manual or sold by Cogentix Medical may result in increased electromagnetic emissions or decreased immunity of the equipment or system.

### Video Processor

The **ENT-5000/ENT-7000** Flexible Video Nasopharyngo-Laryngoscopes are designed to work with the Cogentix Medical **DPU-5000/7000 Series** Digital Video Processors. The endoscopes are not compatible with any other manufacturers' video processors.

### Light Sources

The **ENT-5000/ENT-7000** Flexible Video Nasopharyngo-Laryngoscope has an integrated, solid-state light source which is controlled by the **DPU-5000/7000 Series** Digital Video Processors. No external light source is required for the **ENT-5000/ENT-7000** Flexible Video Nasopharyngo-Laryngoscope.

### Leak Testing

The **ENT-5000/ENT-7000** Flexible Video Nasopharyngo-Laryngoscope may only be leak tested with a Cogentix Medical V1 Endoscope Leak Tester.

### Reprocessing

The **ENT-5000/ENT-7000** Flexible Video Nasopharyngo-Laryngoscope may be reprocessed by a variety of methods. Refer to Chapter 5, **Reprocessing**, for the accessories that will be used when reprocessing the endoscope. Contact Cogentix Medical Customer Service for advice on compatibility issues.

# 4 Preparation, Inspection and Operation

## WARNING

If an abnormality is detected during endoscope preparation, do not use the endoscope; refer to the tables in Chapter 7, **Troubleshooting**. If the problem cannot be solved using the information in that chapter, contact your regional distributor or Cogentix Medical Customer Service.

When using the **Slide-On® EndoSheath® Technology** with the endoscope, refer to the Instructions-for-Use that are shipped with the Sheaths. These instructions will provide complete details on preparing, installing and removing the disposable Sheath.

During the procedure, the temperature at the distal end of endoscope may exceed 41°C (106 °F) due to the intense endoscope illumination. Surface temperatures over 41°C (106 °F) may cause mucosal burns. Always use the minimum level of illumination necessary for adequate viewing. Whenever possible, avoid close stationary viewing and do not leave the distal end of the endoscope in close proximity to mucous membranes for a long time.

The **Slide-On® EndoSheath® Technology** is shipped sterile and intended for a single use only; do not reuse it. When the procedure is complete, remove the Sheath from the endoscope and dispose of it. Reusing the Sheath can damage it, and in turn cause endoscope damage. In addition, a reused Sheath presents a marked infection-control risk to the next patient.

If you are **not** using the **Slide-On® EndoSheath® Technology**, ensure that the endoscope has undergone the appropriate disinfection process. Please refer to Chapter 5, **Reprocessing**, for compatible reprocessing methods and procedures.

A complete review and understanding of the **DPU-5000/7000 Series** User's Manual is recommended before using the **ENT-5000/ENT-7000** Flexible Video Nasopharyngo-Laryngoscope.

---

### Preparation and Inspection

Follow the inspection steps listed below before connecting any equipment or using the system. Do not use the equipment if abnormalities are detected.

#### Select an Installation Site

It is important to select an appropriate location in which to install the Video Processor.

- Place the Video Processor on a stable rigid surface such as a cart, counter-top, or solid stand.
- The location must not contain explosive or flammable gases.
- Place the **ENT-5000/ENT-7000** Videoscope and Video Processor away from radios, televisions, cell phones, or any other devices that emit electromagnetic energy. These can interfere with proper operation. Avoid stacking the videoscope or the Video Processor on other equipment to avoid possible electromagnetic interference.
- Place the Video Processor in a dry place, and avoid contact with liquids.
- Do not allow the Video Processor's vents to be obstructed; full ventilation is necessary for proper operation. Vents are located on the bottom and back of the unit.

1. Check the Insertion Tube for holes, superficial cuts, or abrasions.
2. Lightly run your fingertips over the entire length of the Insertion Tube to confirm that it is smooth and does not exhibit looseness or bagging.

**CAUTION** Do not apply excessive pressure to the endoscope's Insertion Tube. Doing so can damage the internal components of the Insertion Tube.

3. Check for full Distal Tip deflection by actuating the Angulation Lever up and down.

**CAUTION** Avoid applying excessive pressure when using the Angulation Lever. Doing so can damage the angulation mechanism.

4. Clean the Lens on the Distal Tip with an alcohol prep pad.

**CAUTION** **Do not** use abrasive materials to clean the Lens. Doing so could damage the Lens and impair the endoscope's imaging capability.

5. Insert the endoscope's Videoscope Cable Connector into the connector on the front panel of the **DPU-5000/7000 Series** Video Processor, and power on the Video Processor when ready for the procedure.

**CAUTION** Turn off the Video Processor's power switch before connecting or disconnecting the Videoscope Cable. Connecting or disconnecting the cable with the power on could damage both the endoscope and the Video Processor.

---

### Endoscope Operation

**CAUTION** Avoid excessive bending or twisting of the endoscope's Insertion Tube, particularly at the distal end. While the tube is designed to bend, excessive pressure can damage the fiber bundles and internal components.

Excessive angulation or excessive pressure placed on the Angulation Lever may cause equipment damage. Do not exert force to move the lever beyond its natural limits.

1. Hold the endoscope so that the Control Body fits comfortably in your hand, allowing easy manipulation of the Angulation Lever. The other hand is free to manipulate the Insertion Tube.
2. The **DPU-5000/7000 Series** Video Processor should be powered on. Adjust the settings as desired using the Processor's controls.
3. Perform the White Balance procedure.
4. Prepare the patient using normally acceptable clinical practice prior to endoscope insertion.
5. Lubricate the outside of the endoscope (or Sheath, if used) before inserting the endoscope into the patient. Cogentix Medical recommends that the endoscope (or Sheath, if used) be lubricated with water or a water-based lubricant just prior to insertion.
6. Introduce the endoscope (or sheathed endoscope, if the Sheath is used) into the patient using normally acceptable clinical practice. Operate the Angulation Lever as necessary for advancement and observation.



**NOTE:** The four (4) programmable buttons on the endoscope's Control Body may be programmed on the Video Processor to perform designated image-control functions. These functions include:

- ❑ Image Freeze
- ❑ Image Capture
- ❑ Image Enhancement
- ❑ Remote Activation (Copy/Print)
- ❑ Gain
- ❑ Stroboscopy (this function can only be activated when using the Cogentix Medical **STR-5000** Stroboscopy Unit)

Refer to the **DPU-5000/7000 Series** Video Processor User's Manual for further information on available control functions and instructions on programming the Control Buttons.

7. When the procedure is completed, withdraw the endoscope under direct visualization without holding the Angulation Lever. This will allow the Distal Bending Section to move freely during withdrawal.



# 5 Reprocessing

The **ENT-5000/ENT-7000** Flexible Video Nasopharyngo-Laryngoscope can be used either with or without the **Slide-On® EndoSheath® Technology**. The **Slide-On® EndoSheath® Technology** is a sterile, disposable, protective covering which limits the need for elaborate chemical disinfection or sterilization procedures after every endoscopy procedure. The complete system enables the user to implement a fast and effective method of reprocessing an endoscope, and benefits both user and patient by providing an insertion tube covered with a sterile Sheath for every procedure. For cleaning/disinfection procedures when using the **Slide-On® EndoSheath® Technology**, see **Cleaning After EndoSheath® Technology Use** on page 21.

## WARNING

The endoscope must be properly reprocessed by cleaning, disinfecting and/or sterilizing, before its first use and after each subsequent use according to the protocols in this section. Using an endoscope that has not been properly reprocessed presents an acute infection-control risk to both the patient and medical personnel performing or assisting in the procedure.

## CAUTION

Some methods of disinfection and sterilization may be harmful to the endoscope and exposure to them could result in extensive equipment damage. Please contact Cogentix Medical Customer Service to verify the compatibility of a cleaning method not listed in this manual and/or a complete list of functionally compatible agents.

Clean the endoscope immediately after use in a procedure. Failure to do so may allow patient debris to harden on the endoscope's external surfaces, which can become difficult to remove and could inhibit the subsequent disinfection/sterilization processes.

**Do not use an endoscope that has been determined to have a leak, and do not immerse such an endoscope in any fluids. Fluid entry into the endoscope can cause equipment damage and render the endoscope unfit for patient use.**

Always wear appropriate personal protective equipment when reprocessing the endoscope or any of its components. Appropriate protective equipment includes items such as a gown, gloves, and face and eye shields.

Complete and thorough reprocessing of the endoscope is the only way to ensure that a "patient-ready" endoscope is used in all patient procedures. Closely adhere to the reprocessing instructions given in this chapter.

---

### Reprocessing Steps

The endoscope reprocessing procedure is made up of a series of discrete steps, each of which is essential to successful reprocessing. The steps are listed below in their proper order, and the complete instructions for each step are given in greater detail in this chapter.

- **Leak Testing** – The reprocessing procedure requires exposing the endoscope's surface to and immersing the endoscope itself in fluids. If there is a leak in any part of the endoscope, the internal components of the endoscope are vulnerable and will likely be damaged by fluid invasion. Before cleaning, disinfecting and/or sterilizing the endoscope, it is essential to perform a leak test to ensure the interior of the endoscope is resistant to fluids.
- **Cleaning** – Visible debris is removed from the surface of the endoscope in this procedure, which uses water and an instrument-grade detergent. When the **Slide-On® EndoSheath® Technology** is used and inspection after the procedure confirms that the Sheath was not compromised, surface cleaning and intermediate-level disinfection of the endoscope should be sufficient to prepare it for the next procedure.
- **Intermediate-Level Disinfection** – After use with **EndoSheath® Technology** and proper cleaning, the endoscope should undergo intermediate-level disinfection. For the complete routine, see **Cleaning After Slide-On® EndoSheath® Technology Use** on page 21.
- **High-Level Disinfection** – If the endoscope has been contaminated, it will be necessary to immerse the endoscope in a high-level disinfectant.
- **Sterilization** – In addition to high-level disinfection, the endoscope may be sterilized using ethylene oxide (EtO) gas. It must then be thoroughly aerated to ensure that all residues have been removed. The endoscope may also be sterilized using a STERRAD® or STERIS® system. Refer to the STERRAD®/STERIS® section in this chapter.

---

### Leak Testing

The **ENT-5000/ENT-7000** Flexible Video Nasopharyngo-Laryngoscope must be evaluated for possible leaks in the Control Body and/or the Insertion Tube before immersion in any fluids. The Leak Tester accessory should be used for this test (Cogentix Medical Leak Tester is required). Follow the steps given below.

#### **WARNING**

It is essential that gloves be worn when performing the leak test procedure, in case the endoscope's insertion tube has been contaminated and requires further disinfection or sterilization. An endoscope in this condition can present an infection-control risk to the person(s) reprocessing it.

**If the endoscope fails the leak test, do not immerse it in liquids and do not use it in a procedure. Return the endoscope to the manufacturer for service / repair.**

**Attach the Leak Tester to the Endoscope**

Connect the Leak Tester to the endoscope's Vent Valve (see Figure 5-1). Align the slot on the Leak Tester's connector with the pin on the Vent Valve, then push down and rotate the connector clockwise until it locks.

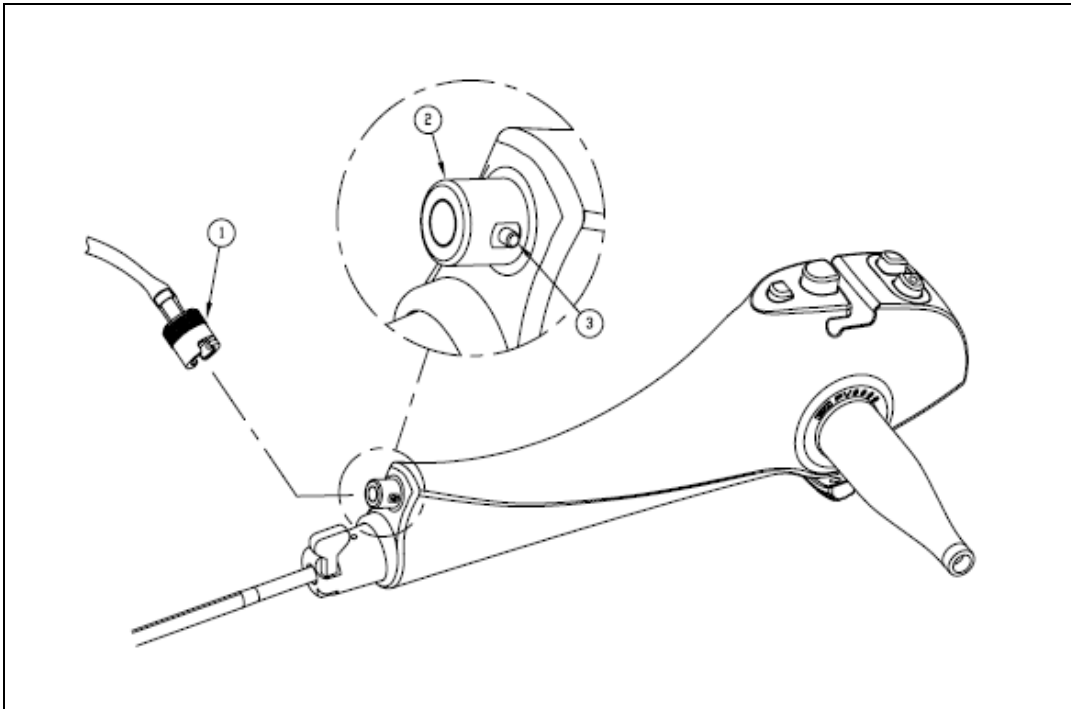

**Figure 5-1: Leak Tester Connection**

**Leak Tester Connection Components:**

1. Leak Tester Connector
2. Vent Valve
3. Alignment Pin (Align with slot in Connector)

**Pressurize the Endoscope**

**CAUTION** The Videoscope Cable's Sealing Cap must be attached to the plug end of the Videoscope Cable Connector prior to leak testing and immersion of the endoscope in water or disinfecting solution.

1. Make sure that the Leak Tester's Pressure-Relief Valve is closed by moving the button to the "out" position.
2. Pump the hand bulb of the Leak Tester until the pressure gauge's needle reaches **the green zone**. Due to the size of the internal space of the endoscope, 2-3 pumps of the hand bulb may be required to pressurize the entire chamber. After the first pump, the needle may drop out of the green zone and reach a stable position in the white zone. Continue with additional pumps until the needle no longer falls back into the white zone.

## Reprocessing

### CAUTION

Do not over-pressurize the interior of the endoscope (do not allow the needle to go above the green area on the pressure gauge). Over-pressurizing the interior of the endoscope can damage the light-transmission and/or optical system components.

3. Maintain the pressure for ten (10) seconds, observing the position of the needle on the pressure gauge. If the pressure decreases, the Sealing Cap of the Videoscope Cable may not be secured onto the plug; or the Leak Tester to endoscope connection may be loose. Check the Pressure-Relief Valve on the Leak Tester, it may still be open and should be closed. Make sure the Sealing Cap is securely placed over the plug; remove and reattach the Leak Tester to the endoscope and repeat Steps 1 through 3.
  - If the pressure decreases after the connections are restored, the endoscope has a damaged seal. **Do not continue to use the endoscope or immerse it in fluids in this condition.** Contact your regional distributor or the Cogentix Medical Customer Service Center to arrange for evaluation and/or repair.
4. If the needle's position remains steady on the Leak Tester, immerse the entire endoscope in water, and observe it for thirty (30) seconds. Angulate the Distal Bending Section up and down while it is immersed, as holes in the soft covering of the Distal Bending Section may not be evident while it is in a neutral position.
5. A steady stream of air bubbles at a given location indicates a small leak in the endoscope that was not detected by the pressure gauge. If a leak is detected, the air pressure in the endoscope will prevent water from entering through the leak. However, immediately remove the endoscope from the water and do not immerse it in any more fluids.

### CAUTION

**Do not continue to use an endoscope if leaks are detected.** Contact your local distributor or the Cogentix Medical Customer Service Center to arrange for evaluation and/or repair. When returning the endoscope, follow the instructions given in Chapter 8, **Warranty and Service**.



**NOTE:** Do not mistake the release of trapped air from the crevices on the endoscope's outer surface for a leak. Trapped air can be released by tapping the endoscope gently after immersing it in water.

6. The absence of air bubbles confirms that the endoscope is watertight. Remove it from the water and open the Leak Tester's Valve.
7. Make sure that the needle on the pressure gauge falls to zero (0), and then disconnect the Leak Tester from the endoscope. The endoscope can now be safely immersed in cleaning solutions.

**CAUTION** Failure to discharge/depressurize the endoscope after leak testing may place stress on the soft covering of the Insertion Tube, potentially producing a “rolling over” of the covering.

## Cleaning, Disinfection, and Sterilization

### Use of the Vent Cap

**CAUTION** Failure to follow the instructions given in this section regarding the use of the Vent Cap may result in damage to the endoscope. Any such damage will void the product warranty.

The Vent Cap is to be **attached** to the endoscope prior to **all** of the following procedures in order to prevent damage to the endoscope caused by changes in pressure and temperature:

- Gas Sterilization
- Aeration
- Shipping

The Vent Cap is to be **removed** from the endoscope prior to:

- Patient Procedures
- Immersion in Fluids

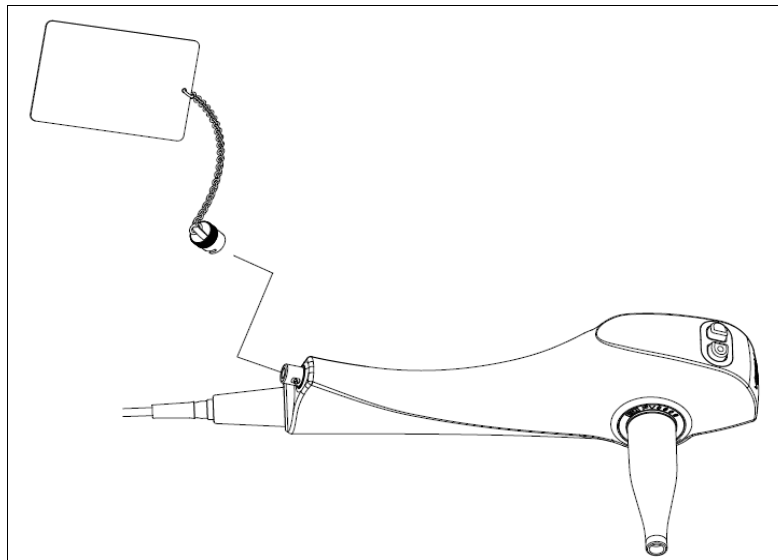

*Figure 5-2: Opening the Vent Valve*

### Cleaning After Slide-On® EndoSheath® Technology Use

**WARNING**

The **Slide-On® EndoSheath® Technology** is intended for a single use only; do not reuse it. When the procedure is complete, remove the Sheath from the endoscope and dispose of it. Reusing the Sheath can present an acute infection-control risk to the user and the next patient on whom the endoscope is used.

## Reprocessing

After a procedure in which the **Slide-On® EndoSheath® Technology** was attached over the endoscope's Insertion Tube, Cogentix Medical recommends performing the following prophylactic and cleaning routine between endoscopic procedures:

### **CAUTION**

Because of the possibility that a Sheath could be torn, or that the endoscope or Sheath could come in contact with contaminated surfaces, the user should develop and follow a prophylactic routine which includes exercising care when handling the endoscope, whether sheathed or unsheathed. It could present an infection-control risk if not handled properly.

1. After removing the Sheath, inspect the Insertion Tube and Distal Bending Section, and confirm that these areas are dry. If moisture is observed, there may have been a leak into the Sheath during the procedure, providing the endoscope was dry when the Sheath was attached. In this case, the endoscope must be high-level disinfected or sterilized following the instructions given in this chapter.
2. **For Cleaning** – Gently wash all external surfaces of the endoscope with an appropriate instrument-grade detergent. An ample size basin must be used for cleaning the endoscope. If the basin is too small, the endoscope may inadvertently be kinked or damaged during cleaning.
3. After washing, thoroughly rinse the outside of the endoscope with clean, lukewarm water and place it on a clean, dry surface.
4. **For Intermediate Level Disinfection** – Wipe down the entire endoscope with a soft, lint-free cloth or gauze soaked in 70% ethyl or isopropyl alcohol.
5. Ensure that all external surfaces of the endoscope are thoroughly dried prior to attaching another Sheath or storing the endoscope.

---

## High-Level Disinfection and Sterilization

In the event that the endoscope is contaminated, it should be high-level disinfected or sterilized after cleaning. Use caution when cleaning and then high-level disinfecting or sterilizing the endoscope.

### Recommended Disinfection and Sterilization Procedures

The following procedures have been determined by Cogentix Medical to be compatible with the **ENT-5000/ENT-7000** Flexible Video Nasopharyngo-Laryngoscope:

- **High-Level Disinfection in Glutaraldehyde:** All Cogentix Medical endoscopes are validated for high-level disinfection in 2.4% glutaraldehyde solutions. Perform the **High-Level Disinfection Protocol** as outlined in this chapter.
- **Sterilization by Ethylene Oxide (EtO) Gas:** The endoscope may be sterilized using a validated EtO protocol. The acceptable processing parameters and procedure are given in the "Ethylene Oxide (EtO) Gas Sterilization" section in this chapter.

- **Sterilization by STERRAD®:** The endoscope may be sterilized using a validated **STERRAD®** protocol. Refer to Table 5-1 on page 26 for the approved systems / cycles suitable for use with this endoscope.
- **Sterilization by STERIS®:** The endoscope may be sterilized using a validated **STERIS®** protocol. Refer to Table 5-1 on page 26 for the approved system suitable for use with this endoscope.

**CAUTION** Disinfection and sterilization methods not listed here may be harmful to the endoscope and could cause extensive equipment damage. Please contact Cogentix Medical Customer Service to determine the compatibility of a disinfection or sterilization method not listed in this manual and/or a complete list of functionally compatible agents.

**Acceptable Reprocessing Materials**

<b>Cleaning</b>	<ul style="list-style-type: none"> <li>• Soft Material Lint-Free Gauze (4x4)</li> <li>• Enzymatic Cleaner</li> <li>• Instrument Grade Detergent</li> </ul>
<b>Intermediate Level Disinfection</b>	<ul style="list-style-type: none"> <li>• 70% Isopropyl Alcohol or</li> <li>• 70% Ethyl Alcohol</li> <li>• Soft Material Lint-Free Gauze (4x4)</li> </ul>
<b>High Level Disinfection</b>	<ul style="list-style-type: none"> <li>• 2.4% Glutaraldehyde-based solution</li> </ul>
<b>Sterilization</b>	<ul style="list-style-type: none"> <li>• EtO Gas Sterilization</li> <li>• STERRAD® 100S, NX, 100NX*</li> <li>• STERIS® System 1E*</li> </ul>

\* Endoscope **must** feature the (S) symbol for STERIS® / STERRAD® compatibility

**Incompatible Methods**

The high-level disinfection and sterilization chemicals and methods shown below are not compatible with the **ENT-5000/ENT-7000** Flexible Video Nasopharyngo-Laryngoscope; **DO NOT USE THEM**, as they could cause extensive damage to the endoscope. If you have any questions regarding the compatibility of a given disinfection or sterilization method, please contact your local distributor or the Cogentix Medical Customer Service Center.

<b>Incompatible High Level Disinfection and Sterilization Methods/Chemicals</b>		
<b>High Level Disinfection Chemicals</b>	<b>DO NOT USE</b>	<ul style="list-style-type: none"> <li>• Chlorines</li> <li>• Formaldehyde</li> <li>• Iodophors</li> </ul>
<b>Sterilization Methods</b>	<b>DO NOT USE</b>	<ul style="list-style-type: none"> <li>• Autoclave</li> <li>• Ultrasonic</li> </ul>

---

### High-Level Disinfection Protocol

If the endoscope was determined to be free of leaks, it may be immersed in a glutaraldehyde solution for the amount of time recommended by the disinfectant manufacturer to achieve high-level disinfection.

**CAUTION** It is imperative that the endoscope be leak tested and cleaned prior to immersion in high-level disinfectant. Failure to do so may not detect leaks that could allow fluid invasion and damage the endoscope. Failure to clean the endoscope may allow gross debris to remain on external surfaces, which could impair proper disinfection.

**In the event that the endoscope fails the leak test, do not immerse the endoscope in fluids and do not use it in a procedure. Return the endoscope to the manufacturer for repair.**

**CAUTION** Make sure that the Sealing Cap is securely attached to the Videoscope Cable prior to immersion. Failure to do so will lead to fluid invasion and severe equipment damage.

#### Pre-Cleaning

1. Gently pat down the Insertion Tube and wipe the Distal Bending Section with a soft, lint-free cloth or gauze (4x4) to remove visible debris.
2. Perform the Leak Test procedure.
3. Gently wash down all external surfaces with an enzymatic cleaning solution and soak the endoscope in the enzymatic cleaning solution for the time recommended by the enzymatic solution's manufacturer.
4. Remove the endoscope from the cleaning solution and rinse it thoroughly with clean, lukewarm water.
5. Dry all external surfaces of the endoscope.

#### Disinfection

1. Immerse the endoscope in the disinfectant solution at the temperature recommended by the disinfectant manufacturer.
2. Allow the endoscope to remain immersed in the disinfectant solution for the period of time recommended by the disinfectant manufacturer.
3. Following disinfection, remove the endoscope from the solution.

#### Rinsing

1. Immerse the endoscope in a container of clean, lukewarm water.
2. Thoroughly rinse the outside of the endoscope with clean, lukewarm water and place it on a clean, dry surface.



3. Wipe all external surfaces of the endoscope with a soft, lint-free cloth or gauze (4x4) until it is completely dry.
4. Confirm that the Lens at the endoscope's Distal Tip is free of disinfectant residue.

---

## Ethylene Oxide (EtO) Gas Sterilization

The **ENT-5000/ENT-7000** Flexible Video Nasopharyngo-Laryngoscope may be sterilized using a validated ethylene oxide (EtO) gas sterilization protocol, following the processing parameters given below.

**CAUTION**

If the Vent Valve is not opened during gas sterilization, the increased heat and pressure from the sterilization process will cause pressure to build up inside the endoscope and could rupture the watertight seals and/or softer materials of the endoscope.

The Videoscope Cable's Sealing Cap must be removed from the Videoscope Cable Connector prior to EtO gas sterilization.

### EtO Gas Sterilization Parameters

**Temperature:** 125° ± 5°F (52°C ± 3°C)

**Relative Humidity:** 50% ± 10%

**EtO Concentration:** 600 mg/liter

**Exposure Time:** 3 hours + 1/-0 hour

**Post-Sterilization Aeration:** 12 hours at 130°F (55°C) or 72 hours at 75°F (24°C)



**NOTE: EtO gas sterilization at the above parameters has been validated by Cogentix Medical, and will sterilize the device to a sterility assurance level (SAL) of 10<sup>-6</sup>.**

**Prior to EtO Gas Sterilization, the endoscope must be leak tested, pre-cleaned and dried as described in the High-Level Disinfection Protocol.**

**CAUTION**

Failure to properly pre-clean the endoscope may inhibit the EtO gas sterilization process.

Prior to Gas Sterilization, the Vent Valve must be opened as shown in Figure 5-2 on page 21 to accommodate the heat and pressure changes of the Gas Sterilization process. To open the Valve, press the red Vent cap onto the Vent Valve, and rotate it clockwise until it is seated and locked.

### After EtO Gas Sterilization

Effective aeration **must** be completed after EtO gas sterilization. Cogentix Medical recommends following the Instructions-for-Use supplied by the manufacturer of the gas sterilizer, and that a biological indicator is used to confirm sterilization efficacy.

## STERRAD® and STERIS® Sterilization

Prior to STERRAD® and STERIS® Sterilization, the endoscope must be leak tested, cleaned and dried as described in this chapter.

The ENT-5000/ENT-7000 Flexible Video Nasopharyngo-Laryngoscope has been validated for material and functional compatibility with the following sterilization systems/ cycles:

STERRAD® 100S	STERRAD® NX	STERRAD® 100NX	STERIS® System 1E
✓ Short and Long Cycles	✓ Short and Long Cycles	✓ Flex Cycle Only	✓

**Table 5-1: STERRAD® and STERIS® Validated Systems/Cycles**

Refer to the STERRAD® or STERIS® Sterilization User’s Manual for complete details on instructions for use.

**CAUTION** Failure to properly clean the videoscope may inhibit the STERRAD® or STERIS® sterilization process.

**CAUTION** The Vent Cap **must** be **attached** for the STERRAD® sterilization process. The Vent Cap must be **removed** for the STERIS® sterilization process.

**CAUTION** STERRAD® and STERIS® sterilization compatibility applies **only** to endoscopes which feature the (S) symbol on the Identification Ring of the Control Body.

# 6 Care and Storage

Follow the instructions in this chapter if you anticipate that the endoscope will not be used for a prolonged period of time. Do not leave the endoscope exposed to the elements in such circumstances.

---

## Storage

Follow the instructions below when storing the **ENT-5000/ENT-7000** Flexible Video Nasopharyngo-Laryngoscope:

- **DO NOT** store the endoscope with a **Slide-On® EndoSheath® Technology** installed on the Insertion Tube. Over time, the Sheath material may adhere to the Insertion Tube and become difficult to remove.
- When storing the endoscope, be sure to keep the Insertion Tube as straight as possible. The Videoscope Cable may be stored either straight or neatly coiled to prevent kinking or bending.
- The endoscope should be completely clean and dry before storing.
- The endoscope should be maintained in a clean condition during storage so that it is ready for subsequent use.
- The endoscope should be stored in a dry, well ventilated environment - avoid high humidity, direct sunlight, and temperatures below -10°C or above 60°C.
- Do not store the endoscope in its carrying case. This case is only intended for endoscope transport; it is not properly ventilated for storage.
- Avoid storing the endoscope in heavily trafficked areas where there is a chance that it may sustain physical damage.

### **CAUTION**

The endoscope should **NEVER** be stored in areas where it could be exposed to liquids or environmental conditions such as high temperature, humidity, direct sunlight, dust, salt, etc., which could adversely affect its operation.

The endoscope should **NEVER** be stored in the presence of flammable or explosive gases or chemicals.

---

### Disposal

The equipment should be returned to Cogentix Medical for disposal. Contact your local Cogentix Medical representative, distributor or service facility for further information.

# 7 Troubleshooting

The information in this chapter is intended to help users diagnose problems that may occur during operation of the endoscope. The tables include some of the problems that could arise during operation, possible causes for those problems, and suggested corrective actions.

**CAUTION** If the problem persists even after the corrective action has been taken, or a problem occurs that is not covered in these tables, do not use the endoscope. Contact Cogentix Medical for repairs using the information given in Chapter 8, **Warranty and Service**.

The **ENT-5000/ENT-7000** Flexible Video Nasopharyngo-Laryngoscope requires a video processor to process and display images. In order to identify issues related to image problems, you may also have to refer to the Troubleshooting chapter in the **DPU-5000/7000 Series** Digital Video Processors User's Manual.

## Troubleshooting

PROBLEM	PROBABLE CAUSE	SUGGESTED ACTION
<b>Angulation feels stiff</b>	<ul style="list-style-type: none"> <li>Damaged Distal Bending Section causing impaired angulation.</li> </ul>	⇒ Return the endoscope to Cogentix Medical, Inc. for repair. Refer to Chapter 8, Warranty and Service.
<b>Angulation alignment is no longer up/down</b>	<ul style="list-style-type: none"> <li>The Insertion Tube has become twisted.</li> </ul>	⇒ Return the endoscope to Cogentix Medical, Inc. for repair. Refer to Chapter 8, Warranty and Service.
<b>Loss of angulation</b>	<ul style="list-style-type: none"> <li>Angulation wires have been stretched or broken during use.</li> </ul>	⇒ Return the endoscope to Cogentix Medical, Inc. for repair. Refer to Chapter 8, Warranty and Service.
<b>Cloudy or foggy images when the endoscope is unsheathed</b>  <b>(If Sheath is used)</b>	<ul style="list-style-type: none"> <li>Patient debris or other material on the Objective Lens.</li> <li>Fluid incursion into the endoscope's optical system.</li> <li>The Lens at the Distal Tip has become damaged.</li> <li>The <b>Slide-On<sup>®</sup> EndoSheath<sup>®</sup> Technology</b> was not applied properly or completely, or the endoscope was not fully inserted into the <b>Slide-On<sup>®</sup> EndoSheath<sup>®</sup> Technology</b>.</li> </ul>	⇒ Clean the Objective Lens with an alcohol prep pad to remove material or stain. Excess staining may not be correctable and the lens may require replacement.  ⇒ Return the endoscope to Cogentix Medical, Inc. for repair. Refer to Chapter 8, Warranty and Service.  ⇒ Return the endoscope to Cogentix Medical, Inc. for repair. Refer to Chapter 8, Warranty and Service.  ⇒ Ensure that the endoscope's Distal Tip has been cleaned prior to attachment of the Sheath, and that the Sheath is attached properly (users should avoid touching the Sheath's Optical Window).

**Table 7-1: Troubleshooting**

PROBLEM	PROBABLE CAUSE	ACTION
<b>No image</b>	<ul style="list-style-type: none"> <li>• Video Processor is not powered on.</li>   <li>• Connection between the endoscope and the Video Processor is lost.</li>   <li>• No video output signal to a monitor.</li> </ul>	<ul style="list-style-type: none"> <li>⇒ Check power cord connection and fuses, or connect the Video Processor to a different mains outlet.</li>   <li>⇒ Check the cable connection between the endoscope and the Video Processor.</li>   <li>⇒ Check the video output cable connections when using an external monitor. Replace the cable if necessary.</li>   <li>⇒ If the problem cannot be corrected, send the endoscope and Video Processor to Cogentix Medical, Inc. for repair.</li> </ul>
<b>Poor quality image from an unsheathed endoscope</b>	<ul style="list-style-type: none"> <li>• Patient debris or other material on the Objective Lens.</li>   <li>• Improper settings on the Video Processor or Display.</li>   <li>• Damaged optics, sensor or electronics in the endoscope.</li> </ul>	<ul style="list-style-type: none"> <li>⇒ Clean the Distal Tip with an alcohol prep pad to remove material or stain. Excess staining may not be correctable and the lens may require replacement.</li>   <li>⇒ Adjust the settings on the Video Processor or Display. Perform a White Balance procedure on the Video Processor.</li>   <li>⇒ Return the endoscope to Cogentix Medical, Inc. for repair. Refer to Chapter 8 Warranty and Service.</li> </ul>

## Troubleshooting

PROBLEM	PROBABLE CAUSE	ACTION
<b>Loss of illumination</b>	<ul style="list-style-type: none"> <li>• Patient material or other substance on the Light Guides.</li> <li>• Light Intensity is set too low.</li> <li>• Damaged light guide fiber bundles.</li> <li>• Internal light source is deteriorating.</li> </ul>	<p>⇒ Clean the Distal Tip with an alcohol prep pad to remove material or stain. Excess staining may not be correctable and the lens may require replacement.</p> <p>⇒ Adjust Light Intensity setting.</p> <p>⇒ Return the endoscope to Cogentix Medical, Inc. for repair. Refer to Chapter 8 Warranty and Service.</p> <p>⇒ Return the endoscope to Cogentix Medical, Inc. for repair. Refer to Chapter 8 Warranty and Service.</p>
<b>Wrinkles and/or folds in the Insertion Tube</b>	<ul style="list-style-type: none"> <li>• These may be a result of excessive force applied to the Insertion Tube during cleaning or Sheath removal, or the long-term effects of repeated immersion in chemical disinfecting solutions, which could stretch and weaken the outer coverings.</li> </ul>	<p>⇒ Return the endoscope to Cogentix Medical, Inc. for repair. Refer to Chapter 8 Warranty and Service.</p>
<b>Insertion Tube is dented</b>	<ul style="list-style-type: none"> <li>• Dents can be caused by physical trauma to the endoscope (e.g., closing the case on the Insertion Tube).</li> </ul>	<p>⇒ Return the endoscope to Cogentix Medical, Inc. for repair. Refer to Chapter 8 Warranty and Service.</p>
<b>Loss of pressure during the leak test</b>	<ul style="list-style-type: none"> <li>• The Leak Tester is not connected properly to the Vent Valve.</li> <li>• The Leak Tester's Pressure-Relief Valve is open.</li> <li>• A hole or crack has broken the endoscope's watertight seal.</li> </ul>	<p>⇒ Re-connect the Leak Tester and perform the test again.</p> <p>⇒ Close the Pressure-Relief Valve.</p> <p>⇒ Return the endoscope to Cogentix Medical, Inc. for repair. Refer to Chapter 8 Warranty and Service.</p>



# 8 Warranty and Service

---

## Warranty Information



**NOTE:** Alterations or repairs done by persons not authorized by Cogentix Medical will void this warranty.

Cogentix Medical is not liable for any damages to the **ENT-5000/ ENT-7000** Flexible Video Nasopharyngo-Laryngoscope resulting from misuse, negligence, or improper cleaning or storage. The warranty defined herein shall apply only to the original buyer. In no event shall Cogentix Medical be liable for anticipated profits, consequential damages or loss of time incurred by the buyer with the purchase or use of this equipment.

**NOTE:** Cogentix Medical sells many of its products through regional distributors. Before sending equipment to Cogentix Medical, contact your regional distributor for repair/return procedures.

Cogentix Medical warrants that the **ENT-5000/ENT-7000** Flexible Video Nasopharyngo-Laryngoscope and its accessories will be free from defects in materials and workmanship **for a period of one year from the date of the invoice**. Replacement parts are warranted **for a period of ninety (90) days from the date of the invoice**.

All non-warranty repairs will be warranted to be free from defects in materials and workmanship **for a period of ninety (90) days from the date of the invoice**.

Upon receipt of the **ENT-5000/ENT-7000** Flexible Video Nasopharyngo-Laryngoscope for repair, Cogentix Medical will evaluate the instrument and make the final decision as to the warranty status.

**The above warranties are in lieu of all other warranties, either expressed or implied, including warranties of fitness or merchantability.**

---

## Cogentix Medical Service Information

**ENT-5000/ENT-7000** Flexible Video Nasopharyngo-Laryngoscopes are serviced at authorized Cogentix Medical repair facilities only. Use the following procedure to expedite returned goods for repair or replacement:

1. Telephone your Regional Distributor, Territory Manager, or Cogentix Medical Customer Service Monday through Friday from 8:00 AM to 7:00 PM EST.

USA customers call **1-866-258-2182**  
International customers call **(+1) 952-426-6189**  
Email: [customer care@cogentixmedical.com](mailto:customer care@cogentixmedical.com)

## Warranty and Service

2. Provide a detailed description of the problem.
3. If troubleshooting cannot solve the problem, a Returned Goods Authorization (RGA) number will be issued.
4. Complete an Incident Report Form and send it to Cogentix Medical along with the returned goods. Returned merchandise will only be accepted with an RGA number.

---

## Shipping to Cogentix Medical or Distributor

### WARNING

If the **ENT-5000/ENT-7000** Flexible Video Nasopharyngo-Laryngoscope has been used in a clinical setting, disinfect all system components before shipping as described in Chapter 5, **Reprocessing**. Shipping contaminated equipment could present an acute infection-control risk for those handling the endoscope, both during shipping and at Cogentix Medical or authorized repair facility.

If the **ENT-5000/ENT-7000** Flexible Video Nasopharyngo-Laryngoscope has been used in a clinical setting but cannot be disinfected before shipping, **place a red biohazard label** on the shipping container to indicate that the contents are contaminated, in accordance with OSHA standards 29 CFR 1910.1030.

Observe the following precautions before shipping the endoscope:

1. Attach the Vent Cap to the endoscope's Vent Valve in preparation for shipping.
2. If the endoscope has a leak or tear or fails the leak test, or for some other reason cannot be disinfected properly as described in Chapter 5, **Reprocessing**, wipe the endoscope down with 70% alcohol to remove debris. Indicate on the outer package that the contents are contaminated.
3. Ship the endoscope in its carrying case. Place the carrying case inside a corrugated box containing protective shipping material to prevent damage during shipment.

Regardless of warranty status, all shipping charges to and from an authorized Cogentix Medical facility are the responsibility of the customer.



**NOTE:** The customer will be contacted and advised of the estimated repair costs. Repairs will not begin on any equipment until authorization or a purchase order has been issued indicating approval of the charges.

# Appendix

## Specifications

SPECIFICATION		ENT-5000/ENT-7000
Distal Tip Diameter	<b>ENT-5000</b>	3.35 mm
	<b>ENT-7000</b>	2.42 mm
Insertion Tube Diameter	<b>ENT-5000</b>	3.45 mm (ref.)
	<b>ENT-7000</b>	2.40 mm (ref.)
Max. Insertion Tube Diameter	<b>ENT-5000</b>	3.65 mm (at joint)
	<b>ENT-7000</b>	2.75 mm (at joint)
Insertion Tube Overall Length	<b>ENT-5000</b>	320 mm
	<b>ENT-7000</b>	320 mm
Field of View		90° (ref.)
Direction of View		0°
Depth of Field		3 - 50 mm
Environmental Effects on Optical Performance		None
Maximum Angulation		140° up/down
Operating Environment		
Temperature		50° to 104° F (10° to 40° C)
Relative Humidity		30 to 85%
Air Pressure		700 to 1060 hPa
Storage Environment		
Temperature		14° to 140° F (-10° to +60° C)
Relative Humidity		0 to 95%
Air Pressure		700 to 1060 hPa
Mode of Operation		Continuous
Electrical Safety		IEC 60601-1 IEC 60601-2-18
Thermal Safety		IEC 60601-1 IEC 60601-2-18
Electromagnetic Compatibility		IEC 60601-1-2
Degree of Protection Against Electrical Shock		Type BF (Body Floating)
Protection Against Fluid Ingress		Fully Immersible (as per Reprocessing Instructions)

**Table A-1: Specifications**

## Electromagnetic Compatibility Declarations



Use of accessories not specified in this manual or sold by Cogentix Medical, Inc. may result in increased electromagnetic emissions or decreased immunity of the equipment or system.

<b>Guidance and manufacturer's declaration – electromagnetic emissions</b>		
The <b>ENT-5000/ENT-7000</b> Flexible Video Nasopharyngo-Laryngoscope with <b>DPU-5000/7000 Series</b> Video Processor [the "System"] is intended for use in the electromagnetic environments specified below. The customer or the user of the System should ensure that it is always used in such environments.		
<b>Emissions Test</b>	<b>Compliance</b>	<b>Electromagnetic environment - guidance</b>
RF emissions CISPR 11	Group 1	The System uses RF energy only for its internal function. Therefore, its RF emissions are very low and are not likely to cause any interference in nearby electronic equipment.
RF emissions CISPR 11	Class A	The System is suitable for use in all establishments, non-domestic, excepting those directly connected to a public low-voltage power supply network that supplies buildings used for domestic purposes.
Harmonic emissions  IEC 61000-3-2	Class A	
Voltage fluctuations/flicker emissions IEC 61000-3-3	Complies	

**Table A-2: Electromagnetic Emissions Declaration**

<b>Guidance and manufacturer's declaration – electromagnetic immunity</b>			
The <b>ENT-5000/ENT-7000</b> Flexible Video Nasopharyngo-Laryngoscope with <b>DPU-5000/7000 Series</b> Video Processor [the "System"] is intended for use in the electromagnetic environments specified below. The customer or the user of the System should ensure that it is always used in such environments.			
<b>Immunity Test</b>	<b>IEC 60601 test level</b>	<b>Compliance level</b>	<b>Electromagnetic environment – guidance</b>
Electrostatic discharge (ESD)  IEC 61000-4-2	±6kV contact ±8kV air	±6kV contact ±8kV air	Floors should be wood, concrete or ceramic tile. If floors are covered with synthetic material, the relative humidity should be at least 30%.
Electrical fast transient/burst  IEC 61000-4-4	±2kV for power supply lines ±1 kV for input/output lines	±2kV for power supply lines ±1 kV for input/output lines	Mains power quality should be the equivalent of that in a typical commercial or hospital environment.
Surge  IEC 61000-4-5	±1 kV differential mode ±2 kV common mode	±1 kV differential mode ±2 kV common mode	Mains power quality should be the equivalent of that in a typical commercial or hospital environment.
Voltage dips, short interruptions and voltage variations on power supply input lines  IEC 61000-4-11	>95% dip $U_T$ for 0.5 cycle 60% dip $U_T$ for 5 cycles 30% dip $U_T$ for 25 cycles 95% dip $U_T$ for 5 sec	Compliant with all levels of voltage dips for $U_T = 100$ VAC and $U_T = 240$ VAC	Mains power quality should be the equivalent of that in a typical commercial or hospital environment. If the user of the System requires continued operation during power mains interrupts, it is recommended that the System be powered from an uninterruptible power supply or a battery.
Power frequency (50/60 Hz) magnetic field  IEC 61000-4-8	3 A/m	3 A/m	Power frequency magnetic fields should be at levels characteristic of a typical location in a standard commercial or hospital environment.

**Table A-3: Electromagnetic Immunity Declaration**

<b>Guidance and manufacturer’s declaration – electromagnetic immunity</b>			
The <b>ENT-5000/ENT-7000 Videoscope</b> connected to the <b>DPU-5000/7000 Series Video Processor</b> [the “System”] is intended for use in the electromagnetic environment specified below. The customer or the user of the System should assure that it is always used in such environments.			
<b>Immunity Test</b>	<b>IEC 60601 test level</b>	<b>Compliance level</b>	<b>Electromagnetic environment – guidance</b>
Conducted RF IEC 61000-4-6	3 Vrms 150 kHz to 80 MHz	3 V	Portable and mobile RF communications equipment should be used no closer to any part of the System, including cables, than the recommend separation distance calculated from the equation applicable to the frequency of the transmitter.  <b>Recommend separation distance</b> $d = 1.17\sqrt{P}$  $d = 1.17\sqrt{P}$ 80MHz to 800MHz  $d = 2.33\sqrt{P}$ 800MHz to 2.5GHz
Radiated RF IEC 61000-4-3	3 V/m 80 MHz to 2.5 GHz	3 V/m	where $P$ is the maximum output power rating of the transmitter in watts (W) according to the transmitter manufacturer and $d$ is the recommended separation distance in meters (m).  Field strengths from fixed RF transmitters, as determined by an electromagnetic site survey, <sup>a</sup> should be less than the compliance level in each frequency range. <sup>b</sup>  Interference may occur in the vicinity of equipment marked with the following symbol:  
NOTE 1: At 80 MHz and 800 MHz the higher frequency range applies.			
NOTE 2: These guidelines may not apply in all situations. Electromagnetic propagation is affected by absorption and reflection from structures, objects and people.			
<sup>a</sup> Field strengths from fixed transmitters, such as base stations for radio (cellular/cordless) telephones and land mobile radios, amateur radio, AM and FM radio broadcast and TV broadcast cannot be predicted theoretically with accuracy. To assess the electromagnetic environment due to fixed RF transmitters, an electromagnetic site survey should be considered. If the measured field strength in the location in which the System is used exceeds the applicable RF compliance level above, the System should be observed to verify normal operation. If abnormal performance is observed, additional measures may be necessary such as re-orienting or relocating the System.			
<sup>b</sup> Over the frequency range 150 KHz to 80 MHz, field strengths should be less than 3 v/m.			

**Table A-4: Electromagnetic Immunity Declaration**

<b>Recommended separation distances between portable and mobile RF communications equipment and the System</b>			
The <b>ENT-5000/ENT-7000 Videoscope</b> connected to the <b>DPU-5000/7000 Series Video Processor</b> [the "System"] is intended for use in the electromagnetic environment in which radiated RF disturbances are controlled. The customer or the user of the System can help prevent electromagnetic interference by maintaining a minimum distance between portable and mobile RF communications equipment (transmitters) and the System as recommended below according to the maximum output power of the communications equipment.			
<b>Radiated maximum output power of transmitter</b>	<b>Separation distance according to frequency of transmitter</b>		
	<b>m</b>		
<b>W</b>	150 KHz to 80 MHz	80 MHz to 800 MHz	800 MHz to 2.5 GHz
	$D = [3.5/V_1]\sqrt{P}$	$D = [3.5/E_1]\sqrt{P}$	$D = [7/E_1]\sqrt{P}$
0.01	D = 0.12	D = 0.12	D = 0.23
0.1	D = 0.37	D = 0.37	D = 0.74
1	D = 1.17	D = 1.17	D = 2.33
10	D = 3.69	D = 3.69	D = 7.38
100	D = 11.67	D = 11.67	D = 23.33
For transmitters rated at a maximum output power not listed above, the recommended separation distance, d, in meters (m) can be estimated using the equation applicable to the frequency of the transmitter, where <i>P</i> is the maximum output power rating of the transmitter in watts (W) according to the transmitter manufacturer.			
NOTE 1: At 80 MHz and 800 MHz the separation distance for the higher frequency range applies.			
NOTE 2: These guidances may not apply in all situations. Electromagnetic propagation is affected by absorption and reflection from structures, objects and people.			

***Table A-5: Recommended Separation Distances***











# Cogentix

## Medical



**Cogentix Medical, Inc.**  
**40 Ramland Road South**  
**Orangeburg, NY 10962 USA**  
**Phone: (866) 258-2182 (toll free in U.S.)**  
**International: (+1) 952 426-6189**  
**Fax U.S.: (866) 255-4522**  
**Fax International: (+1) 952 426-6199**  
**E-Mail: [customer care@cogentixmedical.com](mailto:customer care@cogentixmedical.com)**

[www.cogentixmedical.com](http://www.cogentixmedical.com)

**For additional product information or questions pertaining to sales and service, please contact the local distributor or the manufacturer.**



**MedPass International Ltd.**  
**Windsor House, Bretforton**  
**Evesham, Worcestershire**  
**WR11 7JJ, United Kingdom**



---

© 2008, 2009, 2010, 2012, 2013, 2014, 2015 Cogentix Medical, Inc. Slide-On and EndoSheath are registered trademarks of Cogentix Medical, Inc.

Covered by one or more of the following U.S. Patents: 6,350,231; 6,530,881; 6,733,440.  
Other U.S. and international patents pending.

08/15 09644-EN Rev. F (03915)