

1. Manifolds 2.5" NPT AISI 316SS Schedule 10s ASTM A312 or $\phi 60.3\text{mm}$ x2mm
2. Base/Frame AISI 304SS
3. Full port ball valve ASTM
4. UL Type 3R rated electrical panel
5. Normal/Emergency Switches on front door

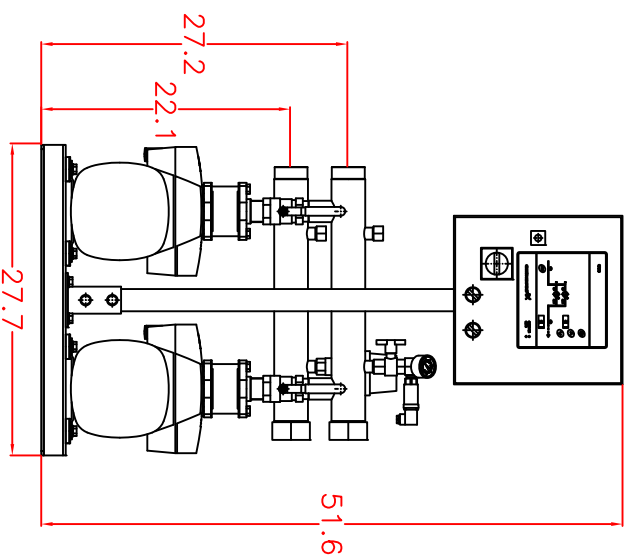

HURLEY ENGINEERING
MANUFACTURERS REPRESENTATIVES

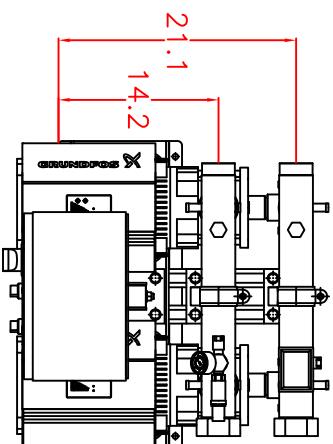
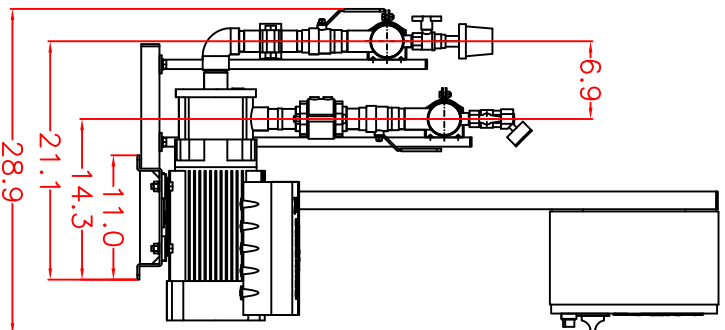

| | | | |
|---------|------------------------------|---------------|--------------|
| Model: | Hydro Multi-B/E 2CME10-3 5hp | | |
| Power: | 208-230/3/60 | | |
| Job: | | | |
| Dwg No: | Rev: 0 | Date: 2-21-14 | Drawer: BSJ |
| | | | Page: 1 of 1 |

Note:
All dimensions are $\pm 1"$
Not for construction use.
All dimensions subject to change
without notice.

