

1. Manifolds 3" 150# AISI 316SS Schedule 10s ASTM A312 or $\phi 60.3\text{mm}$ x2mm
2. Base/Frame AISI 304SS
3. Full port ball valve ASTM
4. UL Type 3R rated electrical panel
5. Normal/Emergency Switches on front door

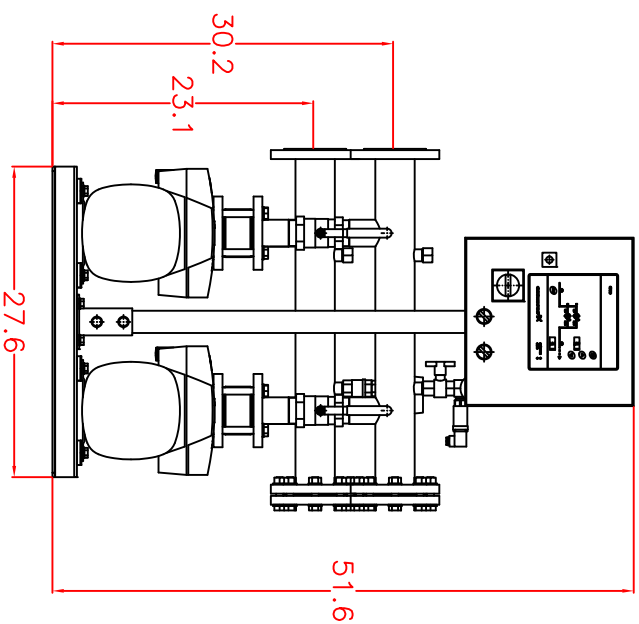

HURLEY ENGINEERING
MANUFACTURERS REPRESENTATIVES

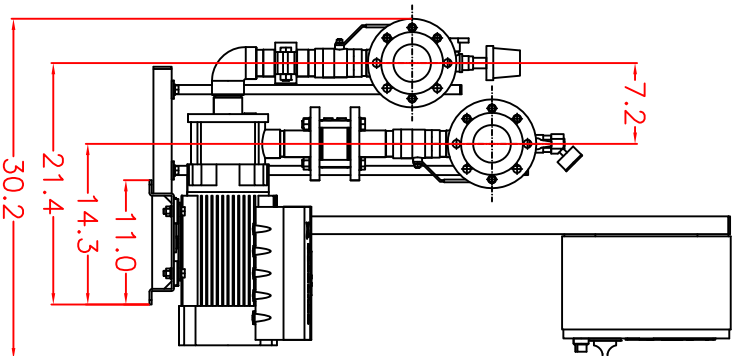
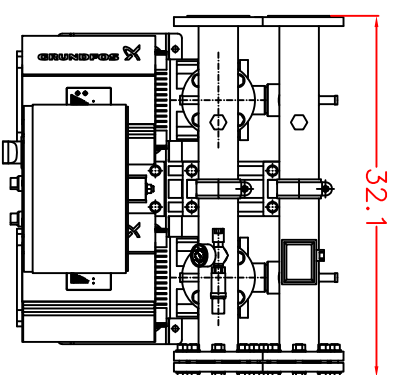

Model:	Hydro Multi-B/E 2CME15-2 5hp		
Power:	460/3/60		
Job:			
Dwg No:	Rev: 0	Date: 2-21-14	Drawer: BSJ
			Page: 1 of 1

Note:
All dimensions are $\pm 1"$
Not for construction use.
All dimensions subject to change
without notice.

