

# VL, VLS

## Vertical inline centrifugal pumps

### Installation and operating instructions

VL

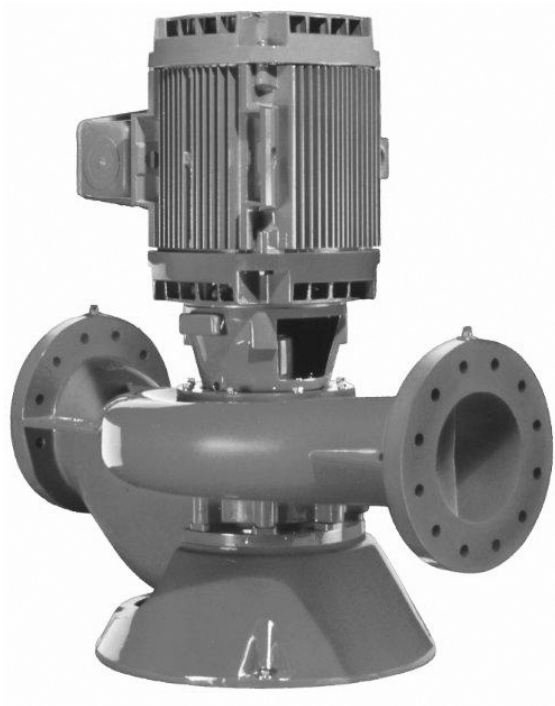

VLS



<b>1. Terms and conditions of sale</b>	<b>2</b>
1.1 The contract	2
1.2 Price	2
1.3 Payment terms	2
1.4 Acceptance and inspection	2
1.5 Title and risk of loss	3
1.6 Patent or trademark information	3
1.7 Changes	3
1.8 Cancellation or termination	3
1.9 Delivery and delays	3
1.10 Warranty	3
1.11 Technical documents	3
1.12 Limitation of liability	3
1.13 This company is an equal opportunity employer	4
1.14 Law and arbitration	4
<b>2. Installation - mechanical</b>	<b>4</b>
2.1 Pump identification	4
2.2 Receiving	4
2.3 Temporary storage	4
2.4 Location	5
2.5 Mounting of pump	5
2.6 Floor mounted pumps (VL, VLS)	5
2.7 Suspended pumps (VL, VLS)	5
2.8 Piping - general	5
2.9 Suction (inlet) piping	5
2.10 Discharge (outlet) piping	6
2.11 Shaft sealing - general comments	6
2.12 Mechanical seals	6
<b>3. Installation - electrical</b>	<b>6</b>
3.1 Motor, general	6
3.2 Installation wiring	6
<b>4. Operation</b>	<b>6</b>
4.1 Priming	6
4.2 Pre-start checklist	7
4.3 Motor rotation	7
4.4 Starting the pump	7
4.5 Voltage regulation	7
4.6 Pump shutdown	7
4.7 Short duration shutdown	7
4.8 Extended period shutdown	7
<b>5. Maintenance</b>	<b>7</b>
5.1 Motor lubrication	7
5.1.1 Standard conditions	7
5.1.2 Severe conditions:	8
5.1.3 Extreme conditions	8
<b>6. Disassembly</b>	<b>8</b>
6.1 Preparation for disassembly	8
6.2 Seal replacement (VL)	8
6.3 Seal replacement (VLS)	8
6.4 Sleeve Replacement (VL)	9
6.5 Wear ring replacement	9
6.6 Reassembly of pumps	9
<b>7. Ordering parts</b>	<b>9</b>
<b>8. Exploded views</b>	<b>10</b>
8.1 Type VL, 56J fractional hp motor (less than 1 hp)	10
8.2 Type VL-JM, integral hp motor (1 hp or greater)	11
8.3 Type VL-JP, motor (packed pumps)	12
8.4 Type VLS, cross section and parts list	13
<b>9. Troubleshooting</b>	<b>14</b>
9.1 Cause codes	14
9.2 Possible causes	14

## 1. Terms and conditions of sale

### 1.1 The contract

The Contract shall be comprised of the following terms, together with such terms and conditions as are set forth in Seller's written proposal or quotation (the "Quotation"), including any documents, drawings or specifications incorporated therein by reference, and any additional or different terms proposed in Buyer's purchase order (the "Purchase Order") that are accepted by Seller in writing, which together shall constitute the entire agreement between the parties, provided, however, that preprinted terms on Buyer's purchase order or invoice shall not apply and Seller gives notice of objection to such terms. An offer by Seller in its Quotation that does not stipulate an acceptance date is not binding. This Contract shall be deemed to have been entered into upon written acknowledgment of the Purchase Order by an officer or authorized representative of Seller, which may not be modified, supplemented, or waived except in a writing executed by an authorized representative of the party to be bound.

### 1.2 Price

The price quoted in the Quotation shall be the Purchase Price unless otherwise agreed in the Purchase Order. The Purchase Price for equipment shall include packing for shipment. Field Services shall be provided at Seller's standard rates. All other costs, including packing for storage, freight, insurance, taxes, customs duties and import/export fees, or any other item not specified in the Contract, shall be paid by Buyer unless separately stated in the Quotation and included in the price quoted. Any sales, use, or other taxes and duties imposed on the transaction or the equipment supplied shall be paid or reimbursed by Buyer.

### 1.3 Payment terms

Payment shall be due within 30 days of the date of Seller's invoice in U.S. funds unless otherwise agreed. If Buyer does not observe the agreed dates of payment, Buyer shall pay interest to Seller on overdue amounts at a rate that is the higher of: 9% per annum or a rate 5% in excess of the rate borne from time to time by new issues of six-month United States Treasury bills. Seller shall be entitled to issue its invoice for the Purchase Price for equipment upon the earlier of shipment, or notice to Buyer that Seller is ready to ship, and for services, upon completion. If the Purchase Price exceeds \$250,000 USD, Buyer shall pay the Purchase Price in Progress payments as follows: Fifteen percent (15%) upon submittal of general arrangement drawings, thirty five percent (35%) after receipt of first Bowl Casting, twenty percent (20%) after first case/bowl hydro test or bowl machining and thirty percent (30%) after notification of ready to ship.

### 1.4 Acceptance and inspection

All equipment shall be finally inspected and accepted by Buyer within 14 days after delivery or such other period of time as is agreed in the Purchase Order. Buyer shall make all claims (including claims for shortages), excepting only those provided for under the warranty clause contained herein, in writing within such 14-day period or they are waived. Services shall be accepted upon completion. Buyer shall not revoke its acceptance. Buyer may reject the equipment only for defects that substantially impair its value, and Buyer's remedy for lesser defects shall be in accordance with Section 10, Warranty. If tests are made by Buyer to demonstrate the ability of the equipment to operate under the contract conditions and to fulfill the warranties in Section 10, Buyer is to make all preparations and incur all expenses incidental to such tests. Seller will have the right of representation

at such tests at its expense, and the right to technically direct the operation of the equipment during such tests, including requiring a preliminary run for adjustments.

### 1.5 Title and risk of loss

Full risk of loss (including transportation delays and losses) shall pass to Buyer upon delivery, regardless of whether title has passed to Buyer, transport is arranged or supervised by Seller, or start-up is carried out under the direction or supervision of Seller. Delivery shall be ex works, INCOTERMS 2000. Loss or destruction of the equipment or injury or damage to the equipment that occurs while the risk of such loss or damage is borne by Buyer does not relieve Buyer of its obligation to pay Seller for the equipment.

### 1.6 Patent or trademark information

If the equipment sold hereunder is to be prepared or manufactured according to Buyer's specifications, Buyer shall indemnify Seller and hold it harmless from any claims or liability for patent or trademark infringement on account of the sale of such goods.

### 1.7 Changes

Buyer may request, in writing, changes in the design, drawings, specifications, shipping instructions, and shipment schedules of the equipment. As promptly as practicable after receipt of such request, Seller will advise Buyer what amendments to the Contract, if any, may be necessitated by such requested changes, including but not limited to amendment of the Purchase Price, specifications, shipment schedule, or date of delivery. Any changes agreed upon by the parties shall be evidenced by a Change Order signed by both parties.

### 1.8 Cancellation or termination

Buyer shall have the right to cancel the Contract upon 15 days' prior written notice to Seller, and Seller shall stop its performance upon the receipt of such notice except as otherwise agreed with Buyer. If Buyer cancels the Contract, it shall pay: (a) the agreed unit price for equipment or components completed and delivered, (b) additional material and labor costs incurred, and for engineering services supplied by Seller with respect to the canceled items, which shall be charged to Buyer at Seller's rates in effect at the time of cancellation, but which shall not exceed the contract price for such items, and (c) such other costs and expenses, including cancellation charges under subcontracts, as Seller may incur in connection with such cancellation or termination.

### 1.9 Delivery and delays

Seller shall use its best efforts to meet quoted delivery dates, which are estimated based on conditions known at the time of quotation. Seller shall not be liable for any nonperformance, loss, damage, or delay due to war, riots, fire, flood, strikes or other labor difficulty, governmental actions, acts of God, acts of the Buyer or its customer, delays in transportation, inability to obtain necessary labor or materials from usual sources, or other causes beyond the reasonable control of Seller. In the event of delay in performance due to any such cause, the date of delivery or time for completion will be extended to reflect the length of time lost by reason of such delay. Seller shall not be liable for any loss or damage to Buyer resulting from any delay in delivery.

### 1.10 Warranty

Seller warrants that the equipment or services supplied will be free from defects in material, and workmanship for a period of 12 months

from the date of initial operation of the equipment, or 18 months from the date of shipment, whichever shall first occur. In the case of spare or replacement parts manufactured by Seller, the warranty period shall be for a period of six months from shipment. Repairs shall be warranted for 12 months or, if the repair is performed under this warranty, for the remainder of the original warranty period, whichever is less. Buyer shall report any claimed defect in writing to Seller immediately upon discovery and in any event, within the warranty period. Seller shall, at its sole option, repair the equipment or furnish replacement equipment or parts thereof, at the original delivery point. Seller shall not be liable for costs of removal, reinstallation, or gaining access. If Buyer or others repair, replace, or adjust equipment or parts without Seller's prior written approval, Seller is relieved of any further obligation to Buyer under this section with respect to such equipment or parts. The repair or replacement of the equipment or spare or replacement parts by Seller under this section shall constitute Seller's sole obligation and Buyer's sole and exclusive remedy for all claims of defects. SELLER MAKES NO OTHER WARRANTY OR REPRESENTATION OF ANY KIND WITH RESPECT TO THE EQUIPMENT OR SERVICES OTHER THAN AS SPECIFIED IN THIS SECTION 10. ALL OTHER WARRANTIES, EXPRESS OR IMPLIED, INCLUDING BUT NOT LIMITED TO, THE IMPLIED WARRANTIES OF MERCHANTABILITY AND FITNESS FOR A PARTICULAR PURPOSE, ARE HEREBY DISCLAIMED. For purposes of this Section, the equipment warranted shall not include equipment, parts, and work not manufactured or performed by Seller. With respect to such equipment, parts, or work, Seller's only obligation shall be to assign to Buyer any warranty provided to Seller by the manufacturer or supplier providing such equipment, parts or work. No equipment furnished by Seller shall be deemed to be defective by reason of normal wear and tear, failure to resist erosive or corrosive action of any fluid or gas, Buyer's failure to properly store, install, operate or maintain the equipment in accordance with good industry practices or specific recommendations of Seller, or Buyer's failure to provide complete and accurate information to Seller concerning the operational application of the equipment.

### 1.11 Technical documents

Technical documents furnished by Seller to Buyer, such as drawings, descriptions, designs and the like, shall be deemed provided to Buyer on a confidential basis, shall remain Seller's exclusive property, shall not be provided in any way to third parties, and shall only be used by Buyer for purposes of installation, operation and maintenance. Technical documents submitted in connection with a Quotation that does not result in a Purchase Order shall be returned to Seller upon request.

### 1.12 Limitation of liability

Seller shall in no event be liable for any consequential, incidental, indirect, special or punitive damages arising out of the Contract, or out of any breach of any of its obligations hereunder, or out of any defect in, or failure of, or malfunction of the equipment, including but not limited to, claims based upon loss of use, lost profits or revenue, interest, lost goodwill, work stoppage, impairment of other equipment, environmental damage, nuclear incident, loss by reason of shutdown or nonoperation, increased expenses of operation, cost of purchase of replacement power or claims of Buyer or customers of Buyer for service interruption whether or not such loss or damage is based on contract, tort (including negligence and strict liability) or otherwise. Seller's maximum liability under this Contract shall not exceed the Purchase Order amount of the equipment or portion thereof upon which such liability is based. All such liability shall terminate upon the expiration of the warranty period, if not sooner terminated.

**1.13 This company is an equal opportunity employer**

This agreement incorporates by reference applicable provisions and requirements of Executive Order 11246 and FAR Section 52.222- 26 (covering race, color, religion, sex and national origin); the Vietnam Era Veterans Readjustment Assistance Act of 1974 and FAR Section 52.222-35 (covering special disabled and Vietnam era veterans); and the Rehabilitation Act of 1973 and FAR Section 52.222- 36 (covering handicapped individuals). By acceptance of this agreement Buyer certifies that it does not and will not maintain any facilities in a segregated manner, or permit its employees to perform their services at any location under its control where segregated facilities are maintained, and further that appropriate physical facilities are maintained for both sexes. Buyer agrees that it will obtain a similar certificate prior to award of any nonexempt lower-tier subcontracts.

**1.14 Law and arbitration**

The Contract shall be governed by the law of the State of Texas. Any disputes arising out of this Contract shall be resolved by informal mediation in any manner that the parties may agree within 45 days of written request for mediation by one party to the other. Any dispute that cannot be resolved through mediation shall be resolved by binding arbitration conducted in English in Portland, Oregon under the Commercial Rules of the American Arbitration Association except as otherwise provided in this Section. The arbitration shall be conducted by three arbitrators chosen in accordance with said Rules. The arbitrators are not entitled to award damages in excess of compensatory damages. Judgment upon the award may be entered in any court having jurisdiction.

**2. Installation - mechanical**

Read these instructions thoroughly before installing and operating your PACO Vertical In-line Centrifugal Pump. Successful operation depends on careful attention to the procedures described in the first four Sections of this manual. Keep this instruction manual handy for future use.

**2.1 Pump identification**

All PACO pumps are identified by catalog and serial numbers. These numbers are stamped on the pump nameplate (Fig.1) affixed to each pump volute casing, and should be referred to in all correspondence with the Company.

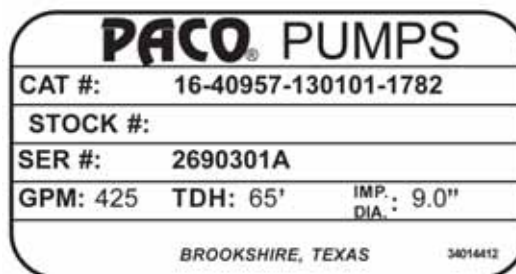

TM05 4873 2612

Fig. 1 Sample nameplate

The first digits in the Catalog Number (preceding the first hyphen) are known as the Product Code. The Product Code may be 2 or 3 digits in length. This installation and Operation Manual applies to the following Product Codes. NOTE: Hyphens may not appear on the name plate.

Product code	Description
16	Paco type VL, in line Centrifugal pump
17	Paco type VLS, in line Centrifugal pump (split coupled)

**2.2 Receiving**

Check pumping unit for shortage and damage immediately upon arrival. Pump accessories when required are packaged in a separate container and shipped with the unit. If equipment is damaged in transit, promptly report this to the carrier's agent. Make complete notations on the freight bill to speed satisfactory adjustment by the carrier. Unload and handle the unit with a sling.



**Do not lift pump assembly by motor eye bolts alone. Motor eye bolts are not designed to support weight of entire pump assembly.**

**2.3 Temporary storage**

If pump is not to be installed and operated soon after arrival, store it in a clean, dry area of moderate ambient temperature. Rotate the shaft by hand monthly to coat bearings with lubricant to retard oxidation and corrosion. Follow motor manufacturer's storage recommendations where applicable.

## 2.4 Location

Locate the pump as close to the suction supply as possible. Use the shortest and most direct suction piping practical. Refer to Section 2.9 *Suction (inlet) piping*. Locate the pump below system level wherever possible. This will facilitate priming, assure a steady liquid flow, and provide a positive suction head. Make sure sufficient NPSH (Net Positive Suction Head) is provided at the suction end by considering the pump's location in relation to the entire system. Available NPSH must always equal or exceed required NPSH specified on the pump performance curve. Always allow sufficient accessibility for maintenance and inspection. Provide a clear space with ample head room for use of a hoist strong enough to lift the pump/motor assembly. Make sure a suitable power source is available for the pump motor. Electrical characteristics should match those specified on the motor data plate, within the limits covered in Sections 3. *Installation - electrical* and 4. *Operation*. Avoid pump exposure to sub-zero temperatures to prevent pump liquid from freezing. If freezing conditions exist during shutdown periods, see Sections 4.7 *Short duration shutdown* and 4.8 *Extended period shutdown* for specific recommendations.

## 2.5 Mounting of pump

PACO In-line centrifugal pumps may be mounted on the equipment room floor, or suspended in the piping, depending on the size and configuration of the pump. The following instructions shall apply:

### 2.6 Floor mounted pumps (VL, VLS)

Pumps mounted on equipment room floors should be permanently installed on a firm, concrete foundation, mounting pad or spring isolation base of sufficient size to dampen any vibration and prevent any deflection. Suitable anchor bolts shall be used to secure the pump assembly to the pad or floor.

### 2.7 Suspended pumps (VL, VLS)

PACO In-line Centrifugal pumps, when properly supported, may be suspended in system piping. Pipe supports must be used on piping immediately adjacent to the pump. Pipe supports must be adequately sized to support the weight of pump and piping, full of liquid, and shall be designed to eliminate transmission of noise or vibration. PACO In line pumps are designed to be mounted in horizontal pipe runs with motor positioned vertically upward. Alternatively, pumps with motor frame sizes of 256JM/JP or smaller may be mounted in vertical pipe runs (risers) or in horizontal pipe runs with motors mounted horizontally. Consult PACO Factory for suitability of mounting with larger motors. In no case shall motors be mounted vertically downward (upside down, with motor positioned below the pump).

## 2.8 Piping - general

### Caution

Do not use pump as a support for piping! Use pipe hangers or other supports at proper intervals to provide complete piping support near the pump.

Both suction and discharge piping should be independently supported and properly aligned so that no strain is transmitted to the pump when flange bolts are tightened. Make sure piping is as straight as possible, avoiding unnecessary bends and fittings. Where necessary, use 45 ° or long-sweep 90 ° pipe fittings to decrease friction loss. Where flanged joints are used, make sure that inside diameters properly match and mounting holes are aligned. Do not spring or force piping when making any connections!

## 2.9 Suction (inlet) piping

The sizing and installation of suction piping is particularly important. It must be selected and installed in a manner that minimizes pressure loss and permits sufficient liquid flow into the pump during starting and operation. Many NPSH problems can be traced directly to improper design of suction piping systems. Observe the following precautions when installing suction piping: Suction piping should be as direct as possible, and ideally the length should be at least ten times the pipe diameter. Short suction piping can be the same diameter as the suction opening. Longer piping should be one or two sizes larger (depending on length), reducing to the diameter of the pump suction opening. Use an eccentric reducer, with the eccentric side down (Fig. 2) when reducing the pipe diameter to the diameter of suction opening.

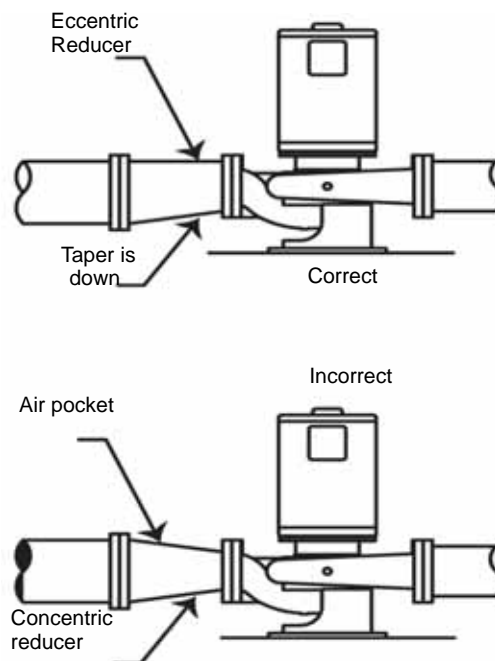
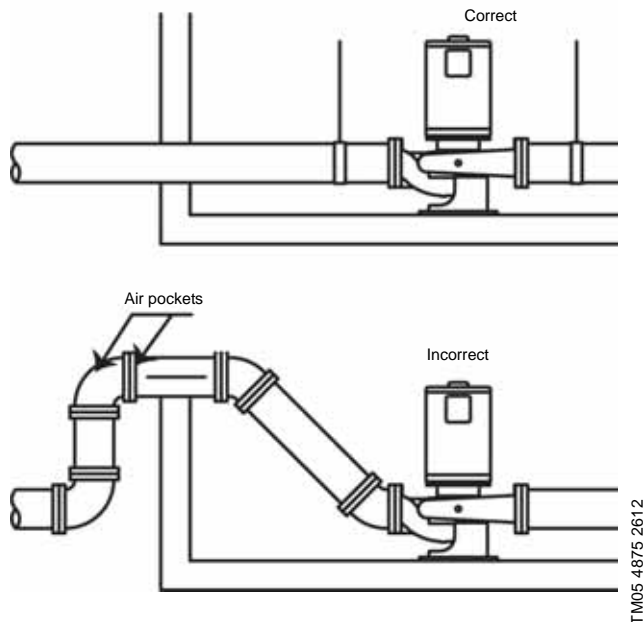

Fig. 2 Eccentric reducer usage

At no point should suction piping be smaller in diameter than the pump suction opening. Avoid any high points, such as pipe loops (Fig. 3), that may create air pockets and throttle the system or produce erratic pumping.

TM 05 4874 2612



**Fig. 3** Eccentric reducer usage

Install a valve in the suction line to isolate the pump during shutdown and maintenance, and facilitate pump removal. Where two or more pumps are connected to the same suction line, install a valve for each pump to isolate pump from the line. Valves should always be installed in positions that avoid air pockets. Globe valves should not be used, particularly when NPSH is critical. During pumping operation, valves on suction line must always be at FULL OPEN. Properly sized pressure gauges can be installed in gauge taps on pump suction and discharge nozzles. Gauges enable the operator to monitor pump performance and determine that the pump conforms to the parameters of the performance curve. If cavitation, vapor binding, or other unstable operation occurs, pressure gauges will indicate wide fluctuation in suction and discharge pressures. Gauge cocks are recommended for use with pressure gauges, to protect gauges from constant wear and vibration when not in use.

### 2.10 Discharge (outlet) piping

Short discharge piping can be the same diameter as the pump discharge opening. Longer piping should be one or two sizes larger depending on length. An even gradient is best for long horizontal runs of discharge piping. Install a valve near the discharge opening to prime and start the pump. The discharge gate valve is also used to isolate the pump during shutdown, maintenance, and facilitate pump removal. Any high points in discharge piping may entrap air or gas and thus retard pump operation.

### 2.11 Shaft sealing - general comments

PACO Type VL and VLS pumps are equipped with mechanical shaft seals.

### 2.12 Mechanical seals

PACO mechanical seals are matched to conditions for which the pump was sold. Unlike packing, mechanical seals require no field adjustments. Observe the following precautions to avoid seal damage and obtain maximum seal life: Do not exceed temperature or pressure limitations for the mechanical seal used.

**Caution**

**Do not run the pump dry or against a closed valve! Dry operation will cause seal failure within minutes.**

Clean and purge suction piping in new installations before installing and operating pump. Pipe scale, welding slag and other abrasives can cause rapid seal failure.

## 3. Installation - electrical

### 3.1 Motor, general

The motor control circuit must have the following components in order to comply with the National Electrical Code Motor Disconnecting Device: A motor disconnecting device must be:

- installed that it is capable of disconnecting both the controller (motor starter) and the motor from their source of power.
- The disconnecting device must be located so that the controller (motor starter) can be seen from the disconnecting means.
- In all cases, the distance from the disconnecting device to the controller must be less than 50'.

In most installations the disconnecting device will be a circuit breaker or fusible disconnect switch. Motor short circuit and ground fault protection: Short circuit and ground fault protection are usually provided by means of a circuit breaker or fusible disconnect switch. The selection of the size of the circuit breaker or fuse must be in accordance with Section 430-52 and Table 430-152 of the National Electrical Code. Motor controller with running over-current protection (magnetic starter) must be installed in accordance with applicable local and state electrical codes in addition to the National Electrical Code. Make sure the motor is properly mounted for easy access to conduit connections, grease fittings and drains. Motor may be rotated upon the bracket of volute casing to achieve a satisfactory position. Starting and overload control devices should match electrical characteristics of motor. For safety and convenience these devices may require installation some distance from the pump. Always follow control manufacturer's instructions for proper installation and connection. Grease lubricated motors are fully lubricated at time of manufacture and do not require further lubrication if prompt installation follows. If motor has been in local storage for six months or longer, refer to Section 5.1 [Motor lubrication](#) and lubricate before starting.

### 3.2 Installation wiring



**Motor wiring to be performed by trained, qualified electricians only. Proper electrical lock-out procedures must be used whenever working on equipment.**

Mount the control panel or motor starter(s) in close proximity to the pump to provide convenient control and ease of installation. Wire panel or starter(s) to motor(s) and pilot device(s): Wires to each motor must be sized for at least 125% of the motor nameplate full load amps. AWG #16 Type THW stranded wire is recommended for wiring of pilot devices (float switches). Check incoming power source to ensure that it is the same as the voltage and phase of the motors. Verify that the starters are suitable to operate the pump motors on voltage and phase that is available.

## 4. Operation

### 4.1 Priming

The PACO in-line centrifugal pumps are not self priming, and must be completely primed (filled with liquid) before starting. If the pump will operate with a positive suction head, prime by opening the suction valve and allowing liquid to enter pump casing. Open all air vents at the high points of pump and piping to ensure air is forced from pump by liquid. Disconnect the recirculation line at the seal housing and bleed completely of all

air. Re-connect the line prior to start-up. Rotate the shaft by hand to free entrapped air from impeller passageways. If pump has a suction lift, priming must be accomplished by other methods. The use of foot valves or ejectors, or manual filling of the pump casing and suction line with liquid are possible methods suggested for this purpose.

**Caution**

**Never run the pump dry in the hope that it will prime itself! Serious damage to the mechanical seal will result.**

## 4.2 Pre-start checklist

Make the following inspections before starting your PACO in-line centrifugal pump: Make sure all wiring connections to the motor (and starting device) match the wiring diagram and produce clockwise rotation as viewed from the end of the motor. If the motor has been in storage for an extended length of time, either before or after installation, refer to motor instructions before starting. Check voltage, phase, and line circuit frequency with the motor data plate. Turn rotating element by hand to make sure it rotates freely. Tighten plugs in gauge and drain taps. If pump is fitted with pressure gauges, keep gauge cocks closed when not in use. Check suction and discharge piping for leaks, and make sure all flange bolts are securely tightened.

## 4.3 Motor rotation

**Caution**

**Verify driver rotation prior to startup and operation. Failure to do so can result in serious damage to pump and driver if rotation is wrong.**

After the unit has been wired and checked to insure that all components in the system (disconnect device, magnetic starters, pilot devices and motors) are properly connected, check motor rotation as follows: For 3 phase units only—momentarily energize the motors to ensure that the rotation is correct as indicated by the arrow cast into the pump volute. If rotation is incorrect, interchange two wires at the motor starter terminals T1 and T2.

**Caution**

**The pumps must not be operated while dry. Energize motors only momentarily to determine proper rotation.**

## 4.4 Starting the pump

1. Install coupling guard on split coupled units.
2. Fully open gate valve (if any) in suction line, and close gate valve in discharge line.
3. Fill suction line with liquid and completely prime pump.
4. Start the motor (pump).
5. Immediately make a visual check of pump and suction piping for pressure leaks.
6. Immediately after pump reaches full operating speed, slowly open the discharge gate valve until complete system flow is achieved.
7. Check discharge piping for pressure leaks.
8. If pump is fitted with pressure gauges, open gauge cocks and record pressure reading for future reference. Verify that the pump is performing in accordance with parameters specified on performance curve.
9. Check and record voltage, amperage per phase, and kilowatts, if a wattmeter is available.

## 4.5 Voltage regulation

The motor will operate satisfactorily under the following conditions for voltage and frequency variation, but not necessarily in accordance with the standards established for operation under rated conditions: The voltage variation may not exceed 10% above or below rating specified on the motor data plate. The frequency variation may not exceed 5% above or below motor

rating. The sum of the voltage and frequency variations may not exceed 10% above or below motor rating, provided the frequency variation does not exceed 5%.

## 4.6 Pump shutdown

The following shutdown procedures will apply in most normal shutdowns for the PACO in-line pump. If pump will be inoperative for an extended length of time, follow storage procedures in Section IC. Always close the discharge gate valve before stopping pump. Close valve slowly to prevent hydraulic shock. Cut power to motor.

## 4.7 Short duration shutdown

For overnight or temporary shutdown periods under nonfreezing conditions, the pump may remain filled with liquid. Make sure the pump is fully primed before restarting. For short or frequent shutdown periods under freezing conditions, keep fluid moving within pump casing and insulate or heat pump exterior to prevent freezing.

## 4.8 Extended period shutdown

For long shutdown periods, or to isolate the pump for maintenance, lock-out power to pump and close suction gate valve. If no suction valve is used and the pump has positive suction head, drain all liquid from suction line to terminate liquid flow into pump suction nozzle. Remove plugs in pump drain and vent taps, as required, and drain all liquid from the pump volute casing. If freezing conditions will exist during long shutdown periods, completely drain the pump and blow out all liquid passages and pockets with compressed air. Freezing of pump liquid can also be prevented by filling the pump with antifreeze solution.

## 5. Maintenance

**Warning**

**Do not attempt any maintenance, inspection, repair or cleaning in the vicinity of rotating equipment. Before attempting any inspection or repair on the pump, the driver controls must be in the "OFF" position, locked and tagged to prevent injury to personnel performing service on the pump. Inspection, maintenance and repair should be performed by trained, qualified personnel only.**



## 5.1 Motor lubrication

To lubricate the motor while running or at rest, remove grease drain plug (if any) and filler plug on grease fitting. Grease with clean lubricant until grease appears at drain hole or along motor shaft. One-half to one cubic inch of grease is sufficient for motors 5 hp and under, with proportionately more grease for greater hp motors.

Recommended lubrication periods				
Motor rpm	Motor hp	Operating conditions		
		Standard	Severe	Extreme
1750 and below	10-40			
	50-150	1-3 yrs	6 mo - 1 yr	6 mo - 1 yr
	200 and Up	1 yr	3 mo	6 mo
Above 1750	All hp	1 yr	3 mo	6 mo
		1 yr	3 mo	3 mo

### 5.1.1 Standard conditions

Eight hours per day operation, normal or light loading, clean air, 100 °F, maximum ambient temperature.

### 5.1.2 Severe conditions:

Continuous 24-hour operation, shock loading or vibration, poor ventilation, 100°-150°F, ambient temperature.

### 5.1.3 Extreme conditions

The following are considered Extreme conditions: Continuous operation, heavy shock or vibration, dirt or dust in air, extreme ambient temperature.

To lubricate motor while running or at rest, remove grease drain plug (if any) and filler plug on grease fitting. Grease with clean lubricant until grease appears at drain hole or along motor shaft. One-half to one cubic inch of grease is sufficient for motors 5 hp and under, with proportionately more grease for greater hp motors. Most fractional and some integral frame motors have "sealed-for-life" bearings, and do not require further lubrication throughout motor life. Always follow motor manufacturer's lubrication instructions, and periodically check grease fittings and drain plugs for leaks. If lubricating instructions do not accompany motor, refer to the following table for recommended lubrication periods.

Recommended bearing Grease for pumps	
Manufacturer	Lubricant
Shell	Dolium
Exxon	Polyrex
Chevron	SRI Grease NLGI 22
	Black Pearl NLGI 2
Phillips	Polytrac
Texaco	Polystar RB

This table lists recommended types of grease for both pump and motor lubrication. These types have all been thoroughly tested and should be used whenever possible.

**Caution** *Do not lubricate with lithium based grease. Equipment damage will result.*

## 6. Disassembly

### 6.1 Preparation for disassembly

#### Warning

**Turn off power, lock-out electrical breaker and provide appropriate "Do Not Operate" or equivalent signage prior to any work on equipment. Verify all power is off at pump using appropriate electrical instrumentation. Work should be performed only by qualified and trained personnel.**



Complete disassembly instructions are outlined below. Proceed only as far as required to perform the maintenance work needed. Close valves on suction and discharge side of pumps and drain pump, taking precautions as necessary based on fluid being pumped. Flush, if necessary. Allow adequate working area around pump for maintenance or disassembly.

### 6.2 Seal replacement (VL)

1. Complete preparations noted in Section [6.1 Preparation for disassembly](#), above.
2. Unscrew tubing connector from pipe tee of Air Vent assembly (15A) if equipped.
3. Remove Casing Bolts (8B).
4. Back-pull rotating assembly away from Volute (1A). Make sure external wiring will not be torn from motor leads before pulling.
5. Remove Volute Gasket (11A) from outer face of back plate/

bracket, and discard. New sealing gaskets should always be used whenever pump is reassembled.

6. For replacement of Wear Ring (4A), refer to Section [6.5 Wear ring replacement](#) at this time.
7. For replacement of Seal, Sleeve or for general disassembly, continue with the following instructions
8. Impeller removal procedures vary depending on motor type. Follow appropriate instructions as follows:

#### Impeller removal- fractional horsepower motors

Impeller (3A) is threaded on to fractional horsepower (56J) motor shaft. Loctite is applied to impeller threads during factory assembly. If adhesive shear strength is too great for disassembly with ordinary hand tools parts must be heated by torch and disassembled while hot. Apply torch heat to impeller eye when unscrewing threaded impellers, axially along shaft sleeve exterior to loosen for removal. Holding power of Loctite decreases as temperature rises, and compound completely decomposes at temperatures above 650°F. Impeller must be unscrewed, while preventing motor shaft rotation by utilizing a large screwdriver securely in slot at back end of motor shaft while unscrewing impeller.

**Caution** *Do not insert screwdriver between impeller vanes to prevent rotation. Use strap wrench around the impeller or shaft to prevent rotation.*

#### Impeller Removal- Integral Horsepower Motors:

Impeller (3A) is keyed onto integral horsepower (JM & JP) motor shaft. Slide impeller axially off of shaft. If impeller can not be removed by hand, additional leverage may be necessary. Using a gear puller or two pry bars, position the tongs in close proximity to impeller vanes and carefully apply smooth, even force to the impeller. Excessive force will distort and damage the impeller.

1. Remove and discard spring and retainer from seal assembly (14A).
2. Remove seal head assembly manually from Shaft Sleeve (5A). Water-soluble lubricant may be applied to shaft to ease removal of Shaft Seal (14A). Pull seal head assembly manually from shaft, using slight twisting motion (as necessary) to loosen bellows from shaft sleeve.
3. Remove and discard seal seat from Bracket (21A). Thoroughly clean the inside cavity of bracket or cap.
4. For replacement of Shaft Sleeve (5A), refer to Section [6.4 Sleeve Replacement \(VL\)](#) at this time.
5. Interior surface of bellows on new seal head is coated with bonding agent that adheres to motor shaft. When old seal head is removed, bonding agent no longer exists and bellows may crack or split during removal. Installation of new mechanical seal is always recommended if it becomes necessary to remove existing seal from shaft.
6. Clean and lubricate shaft sleeve (shaft on 56J motors) with water-soluble lubricant and make sure no sharp edges exist which could cut bellows of new seal.
7. Press new seal seat firmly into bracket or cap. Avoid direct contact of seal face with metallic or abrasive objects and wipe clean after installation to ensure abrasive-free sealing surface.
8. Slide new seal head assembly onto shaft by applying even pressure to base of assembly. Make sure sealing faces fit snugly.
9. See Reassembly instructions, Section [6.6 Reassembly of pumps](#).

### 6.3 Seal replacement (VLS)

1. Complete preparations noted.
2. Remove coupling guard (34F).



- Remove coupling bolts (8E). Pry apart the coupling halves (23D), remove keys (12B) and set aside.

**Note**

**Mark or measure the original position of the pump coupling on the motor side.**

- Unscrew tubing connector from pipe tee of air vent assembly. Pipe dope is applied to threads during factory assembly, and resulting bond may retard but will not prevent manual disassembly.
- Remove seal cap bolts and slide seal cap (2N) up shaft to remove.
- Remove seal head assembly manually from shaft (6A). Water-soluble lubricant may be applied to shaft to ease removal of shaft seal (14A). Pull seal head assembly manually from shaft, using slight twisting motion (as necessary) to loosen bellows from shaft.
- Remove and discard seal spring and retainer.
- remove and discard seal seat from seal cap (2N) and thoroughly clean the inside cavity of seal cap.
- Interior surface of bellows on new seal head is coated with bonding agent that adheres to motor shaft. When old seal head is removed, bonding agent no longer exists and bellows may crack or split during removal. Installation of new mechanical seal is always recommended if it becomes necessary to remove existing seal from shaft.
- Clean and lubricate shaft (6A) with water-soluble lubricant and make sure no sharp edges exist to cut or scratch bellows of new seal.
- Press new seal seat firmly into seal cap. Avoid direct contact of seal face with metallic or abrasive objects and wipe clean after installation to ensure abrasive free sealing surface.
- Slide new seal head assembly onto shaft by applying even pressure to base of assembly.
- Install seal cap (2N) down shaft.
- See reassembly instructions.

#### 6.4 Sleeve Replacement (VL)

- Remove impeller key (12A) from shaft (integral horsepower motors only)
- Sleeves are bonded to shaft using Loctite. Loctite adhesive compound is a liquid resin that produces a tough bond when applied to threaded and close-fitting connections during assembly. It is used by PACO on shaft sleeves to secure sleeve to shaft.
- Apply light torch heat axially along shaft sleeve exterior to break the Loctite bond and loosen sleeve for removal. Excessive heating is not necessary, and should be avoided to protect bearings. Remove sleeve.
- Wipe or brush clean all adhesive surfaces before reapplying Loctite. Use LocQuic Primer or equivalent for preparation of surface. LocQuic Primer is a degreasing agent recommended for use in preparing mating surfaces for Loctite application. Do not use gasoline or other petroleum products for cleaning, because an oily surface will remain. Assemble shaft sleeves with twisting motion to ensure an even hold, and always make sure sleeve is firmly in place against shaft shoulder. Allow a few minutes for Loctite to bond prior to completing assembly.

#### 6.5 Wear ring replacement

- Complete preparations
- Back-pull rotating assembly,
- It may be necessary to remove volute (1A) from piping, to facilitate easy access to interior of volute. If necessary, remove flange bolts at piping.
- To remove worn Case Wear Ring (4A), drill two holes slightly

smaller than width of ring into exposed edge of ring. Once holes are drilled, a chisel may be used to completely sever ring at holes and break ring into two halves for easy removal.

- Clean the ring cavity in the volute prior to installing wear ring to ensure a properly aligned fit.
- To reassemble, press fit new wear ring squarely into volute casing cavity. Ring may be tapped into place to make sure it is completely impressed into cavity.

**Caution**

**Do not use metal tooling against wear ring surfaces. Use only rubber, rawhide, wood or other soft material to prevent damage to ring.**

#### 6.6 Reassembly of pumps

- Clean all parts prior to reassembly, ensuring all contacting surfaces and threads are free of debris. Reassemble pump by following the above instructions in reverse. Inspect and ensure the following:
  - All mechanical seal components and shaft sleeve must be in good condition or leakage may result.
  - Replacement of complete seal assembly is recommended.
  - Appropriate Loctite is used in re-assembly of shaft sleeves.
  - Appropriate Loctite is used in re-assembly of threaded impellers.
- Re-install coupling guards on coupled pumps.

**Warning**

**Type VLS pump is a split coupled pump. Coupling guard must be reinstalled and in place prior to operation.**

#### 7. Ordering parts

PACO's commitment to state-of-the-art pump design and quality manufacturing assures maximum user benefits with optimum equipment life at lower cost. PACO's commitment to their customers continues through an extensive service organization. Highly trained technicians can assist customers with initial startup, troubleshooting, repair, and system analysis. PACO maintains an extensive stock of replacement parts and parts kits for our most popular model pumps. Shipment of these parts is normally made within three days after receipt of an order. On larger pumps, where it is impractical for our factory to inventory low usage parts, replacement parts are normally manufactured and shipped within 15 working days of receipt of an order. In order to reduce pump repair time and shorten inconvenient pump service interruptions, it is suggested that the pump user stock spare parts. For suggested spare parts see Replacement Parts Guide A3b.2, and contact your local PACO Sales Representative (see back cover for the number of your nearest PACO sales office). Since spare parts requirements and quantities vary for specific pump constructions, allow your PACO Representative to help in defining your spare part requirements. To ensure that the proper replacement parts are ordered for your particular pump model, when you call: Identify all pertinent data from the pump name plate (see Pump Identification ). This should always include the pump Catalog or Model Number, and the pump Serial Number. For replacement impellers, also include from the nameplate the operating conditions (GPM and TDH) and the impeller diameter. Identify all parts by item number and description as indicated by the appropriate assembly drawing in this manual, for your particular pump model.

## 8. Exploded views

### 8.1 Type VL, 56J fractional hp motor (less than 1 hp)

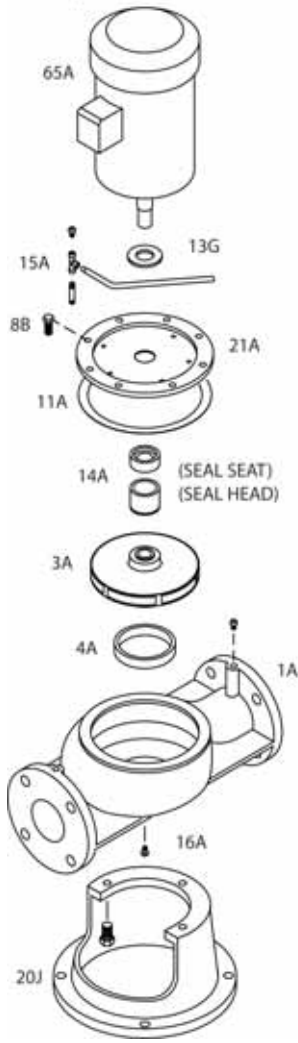

Parts list	
Label	Description
1A	Volute
*	3A Impeller
*	4A Case wear ring
8B	Volute capscrow
*	11A Volute gasket
13G	Slinger
*	14A Seal assembly
15A	Recirc tubing
16A	Pipe plug
20J	Cast iron stand
21A	Motor bracket
65A	Motor, 56J frame

\* Recommended spare parts

TM05 4877 2612

## 8.2 Type VL-JM, integral hp motor (1 hp or greater)

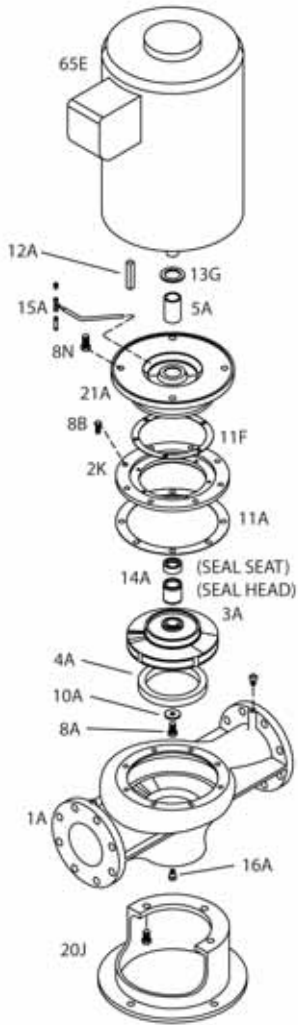

TM05 487B 2612

### Parts list

Label	Description
1A	Volute
2K	Back plate
* 3A	Impeller
* 4A	Case wear ring
* 5A	Shaft sleeve
* 8A	Impeller screw
8B	Volute screw
8N	Motor screw
* 10A	Impeller washer
* 11A	Volute gasket
* 11F	Bracket gasket
* 12A	Impeller key
13G	Slinger
* 14A	Seal assembly
15A	Recirc tubing
16A	Pipe plug
20J	Cast iron stand
21A	Motor bracket
65E	Motor, JM frame

\* Recommended spare parts

8.3 Type VL-JP, motor (packed pumps)

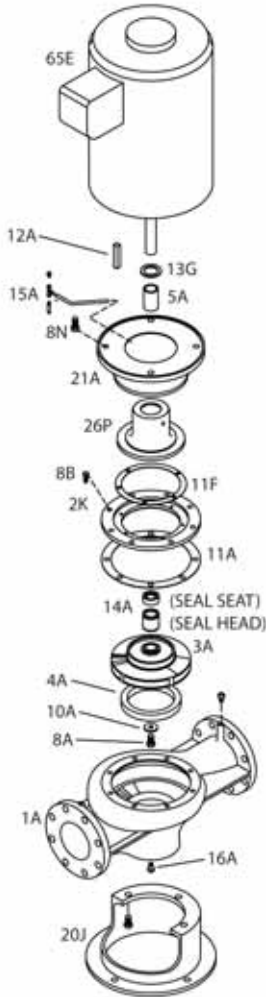

Parts list

Label	Description
1A	Volute
2K	Back plate
* 3A	Impeller
* 4A	Case wear ring
* 5A	Shaft sleeve
* 8A	Impeller screw
8B	Volute screw
8N	Motor screw
* 10A	Impeller washer
* 11A	Volute gasket
* 11F	Bracket gasket
* 12A	Impeller key
13G	Slinger
* 14A	Seal assembly
15A	Recirc tubing
16A	Pipe plug
20J	Cast iron stand
21A	Motor bracket
26P	Seal cap
65E	Motor, JM frame

\* Recommended spare parts

8.4 Type VLS, cross section and parts list

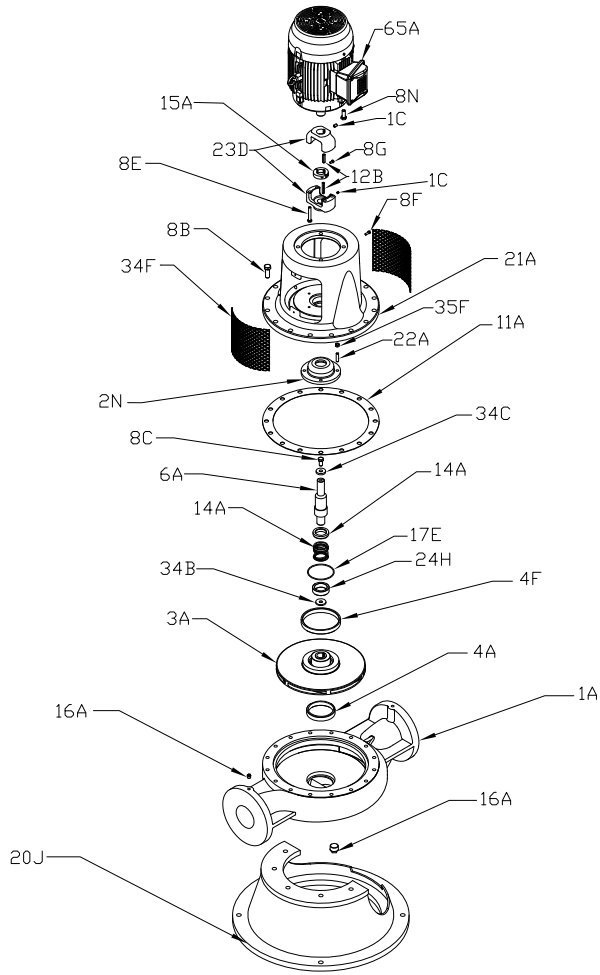

TM05 6921 0213

Parts list		
Label	Description	
1A	Volute	
1C	Set screw	
2N	Seal cap	
*	3A	Impeller
*	4A	Case wear ring
	4F	Balance ring
	6A	Pump shaft
	8B	Volute screw
	8C	Pump shaft screw
	8E	Coupling screw
	8F	Coupling guard screw
	8G	Locating ring screw
	8N	Motor screw
*	11A	Volute gasket
	12B	Coupling key
*	14A	Seal assembly
	15A	Locating ring
	16A	Pipe plug
	17E	Seal cap o-ring
	20J	Cast iron stand
	21A	Motor bracket
	22A	Seal cap studs
	23D	Coupling halves
	24H	Bushing
*	34B	Impeller washer
	34C	Pump shaft washer
	34F	Coupling guard
	35F	Seal cap nut
	65A	Motor

\* Recommended spare parts

## 9. Troubleshooting

### 9.1 Cause codes

Symptoms	Cause code
Pump does not deliver any liquid at start-up	1*2*3*4*5*6*7*8*9*10*11*14*16*17*22*23*24*34
Pump stops delivering liquid after start-up	2*3*4*5*6*7*8*9*10*11*12*13*22*23*24*34
Pump overheats and/or ceases to deliver liquid	1*3*9*10*11*21*22*27*29*30*31*33*34*40*41
Insufficient flow rate	2*3*4*5*6*7*8*9*10*11*14*16*17*20*21*22*23*24*25*26*34
Excessive flow rate	15*18*20*34
Discharge pressure is too high	4*14*16*18*20*22*23*24*25*26*34
Shaft seal leaks appreciably, or the packing leaks excessively	27*28*29*30*33*34*35*36*39
Shaft seal or packing fails prematurely	12*13*27*28*29*30*33*34*35*36*37*38*39
Pump uses too much power	15*16*18*19*20*23*25*27*28*31*33*34*35*37*38
Pump runs rough and noisily	2*3*4*5*6*7*8*9*10*11*15*17*18*21*23*24*27*28*29*30*31*32*33*34*40

### 9.2 Possible causes

- The pump has not been properly bled of air.
- The pump suction line has not been completely primed.
- The suction head (NPSHR) required by the pump is too high, or the net positive suction head available (NPSHA) at your facility is too low.
- The fluid pumped contains too much entrained air or gas.
- There are air pockets in the suction line.
- An entry of air has suddenly occurred in the suction line.
- An entry of air past the shaft seal into the pump has occurred.
- The inlet of the suction line is insufficiently submerged.
- The suction valve is closed or only partially open.
- The suction strainer is clogged with dirt or debris.
- The foot valve is clogged or undersized.
- Little or no cooling fluid supplied to the shaft seals.
- The lantern ring is not positioned opposite the flushing inlet thereby restricting fluid flow.
- Pump drive rotational speed too low.
- Pump drive rotational speed too high.
- Pump rotation wrong or impeller installed backwards.
- Total head of installation (back pressure) higher than rated total head of the pump.
- Total head of installation (back pressure) lower than rated total head of the pump.
- Density of fluid pumped differs from that specified when the pump was purchased.
- Viscosity of fluid pumped differs from that specified when the pump was purchased.
- The pump is operating at too low a rate of flow. The discharge valve may be throttled too much.
- If pumps are operating in parallel, the pump characteristics may not be suitable for parallel operation.
- The impeller may be clogged with debris.
- The impeller may be damaged.
- The casing and impeller wear rings may be excessively worn.
- There may be internal leakage from the discharge to the suction compartments as the result of internal gasket failure.
- There may be a misalignment of the pump shaft.
- The shaft may chatter because it is bent.
- The pump may run rough due to improper balancing of the impeller.
- The shaft may not be running due to worn bearings.
- The impeller may be rubbing against the inside of the case.
- The concrete pad might not be of sufficient size to provide pump stability.
- The pump may have become misaligned during installation.
- The operating conditions of the installation do not agree with the data specified when the pump was purchased.
- The shaft seal may be incorrectly installed, or the stuffing box has not been packed correctly.
- The shaft sleeve may be scored or pitted in the region of the packing due to dirt or abrasive matter in the flushing fluid.
- Excessive tightening of the packing gland may block the flushing port thereby diminishing the sealing fluid flow.
- Packing material may have become wedged or extruded between the shaft and the bottom of the stuffing housing due to excessive clearance on the packing backup washer.
- The mechanical seal may have been damaged by running dry.
- There may be excessive axial thrust (side loading) due to improper impeller central alignment.

U.S.A.  
Grundfos CBS, Inc.  
902 Koomey Road  
Brookshire, TX 77423 USA  
Phone: 281-994-2700  
Toll Free: 1-800-955-5847  
Fax: 1-800-945-4777

<b>98434722</b> 0213
ECM: 1109065

The name Grundfos, the Grundfos logo, and **be think innovate** are registered trademarks owned by Grundfos Holding A/S or Grundfos A/S, Denmark. All rights reserved worldwide. © Copyright Grundfos Holding A/S