

Count	Description
-------	-------------

1 HYDRO MPC E 3CRE20-04 3X460V BASIS



Product photo could vary from the actual product

Product No.: [95055172](#)

Pressure booster system supplied as compact packaged assembly certified and listed by UL (Category QCZJ - Packaged Pumping Systems) for conformance to U.S. and Canadian Standards.

All pumps are speed-controlled.

Each pump is equipped with an integrated variable frequency drive motor (MLE motor).

- Hydro MPC-E maintains constant pressure through continuous adjustment of the speed of the pumps.
- The system performance is adapted to the demand through cutting in/out the required number of pumps and through parallel control of the pumps in operation.
- Pump changeover is automatic and depends on load, operating hours and fault.
- All pumps in operation will run at equal speed.

The system consists of these parts:

- 3 vertical multistage centrifugal pumps, type CRE20-04.
- Pump rotating parts in contact with the pumped liquid are made of ANSI 304 stainless steel as standard and ANSI 316 stainless steel as an option.

Pump bases and pump heads are made of cast iron (Class 30) as standard and ANSI 316 stainless steel as an option.

The pumps are equipped with the service-friendly cartridge type mechanical shaft seal HQQE (SiC/SiC/EPDM).

- Suction manifold and discharge manifold made of 316 stainless steel.
- Base frame made of 304 stainless steel.
- One non-return valve (check valve), and two isolating valves for each pump.
- Adapter with isolating valve for connection of diaphragm tank.
- Pressure gauge and pressure transducer on each suction and discharge manifold.

Dry-running protection is standard with use of pressure transducer on suction manifold.

- Control MPC in a NEMA 4 steel control panel enclosure including main disconnect switch, all required fuses, motor protection, switching equipment and microprocessor-controlled CU 351.

Diaphragm tank is available as an accessory.



Company name: Hurley Engineering
Created by:
Phone:

Date: 3/20/2020

Count	Description
	<p>Pump operation is controlled by Control MPC with the following features/functions:</p> <ul style="list-style-type: none">- Advanced multi-pump controller (CU 351), specifically designed to control parallel operation of multiple pumps- PID controller with adjustable PI parameters (Kp + Ti)- Constant pressure at setpoint, independent of inlet pressure- Stop function (no flow shutdown)- Automatic cascade control of pumps for optimum efficiency.- Selection of min. time between start/stop, automatic pump changeover and pump priority- Automatic pump test function to prevent idle pumps from seizing up- Standby pump allocation capability- Redundant primary sensor capability- Manual operation- Proportional pressure control- Forced pump changeover- Clock program- Soft pressure build-up- External setpoint influence (via analog input)- Emergency run (via digital input)- Password protection- Possibility of digital remote-control functions (via digital inputs):<ul style="list-style-type: none">• system on/off• max., min. or user-defined duty• up to 6 alternative setpoints.<ul style="list-style-type: none">- Digital inputs and outputs can be configured individually- Pump and system monitoring functions:• minimum and maximum limits of current value (flow, level, temp., etc.)• inlet pressure• motor protection• high system pressure• low system pressure• pump curve data loaded into controller to provide end of curve protection• alarm log with the previous 24 warnings/alarms<ul style="list-style-type: none">- Display and indication functions:• 320 x 240 pixels graphical display with backlight• green indicator light for operating indications and red indicator light for fault indications• potential-free changeover contacts for operation and fault.<ul style="list-style-type: none">- Grundfos bus communication with optional gateway connections for LON, Modbus, Profibus, BACnet, GSM- Ethernet connection (built-in web server) <p>Pre-fabricated and tested packaged pump system including pumps, piping, and wiring complete with Control MPC.</p> <p>Flow media: Water Allowed liquid temp.: 32 °F .. 140 °F System pressure max.: 232.06 psi Flow (Plant): 453 US gpm Flow without one stand-by pump acc. DIN 1988/T5: 453 US gpm Flow (Pump): 279 US gpm Head: 240 ft Mains suply: 3X460-480V, 60 Hz Nom. current of plant: 37.8 A Number of main pumps: 3 Nominal power: 10 HP</p>



Company name: Hurley Engineering
Created by:
Phone:

Date: 3/20/2020

Count	Description
	Starting main: electronically Suction port: 102 Discharge port: 102 Net weight: 961 lb



Company name: Hurley Engineering
Created by:
Phone:

Date: 3/20/2020

95055172 HYDRO MPC E 3CRE20-04 3X460V BASIS 60 Hz

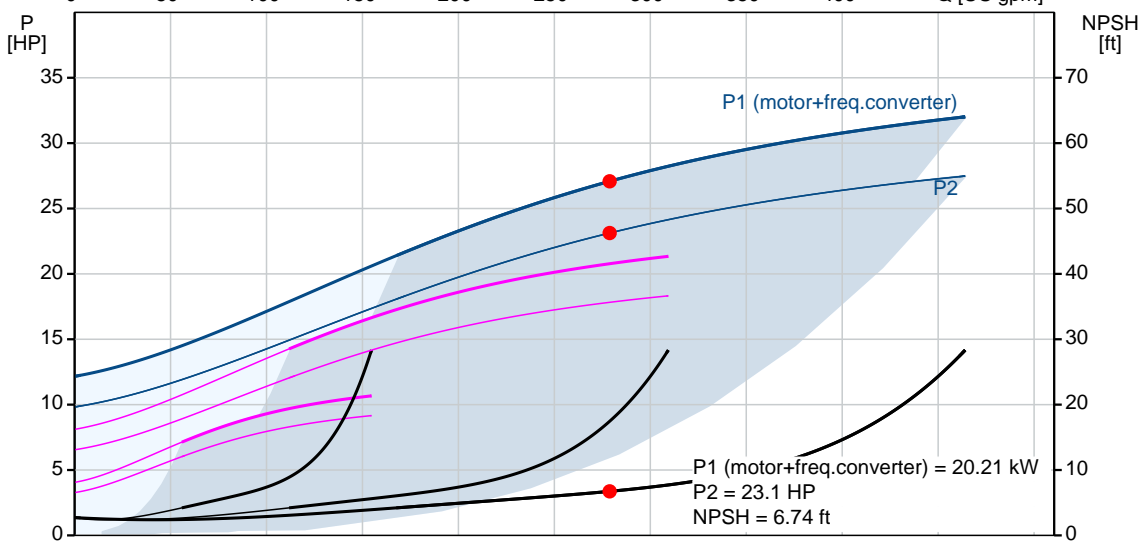
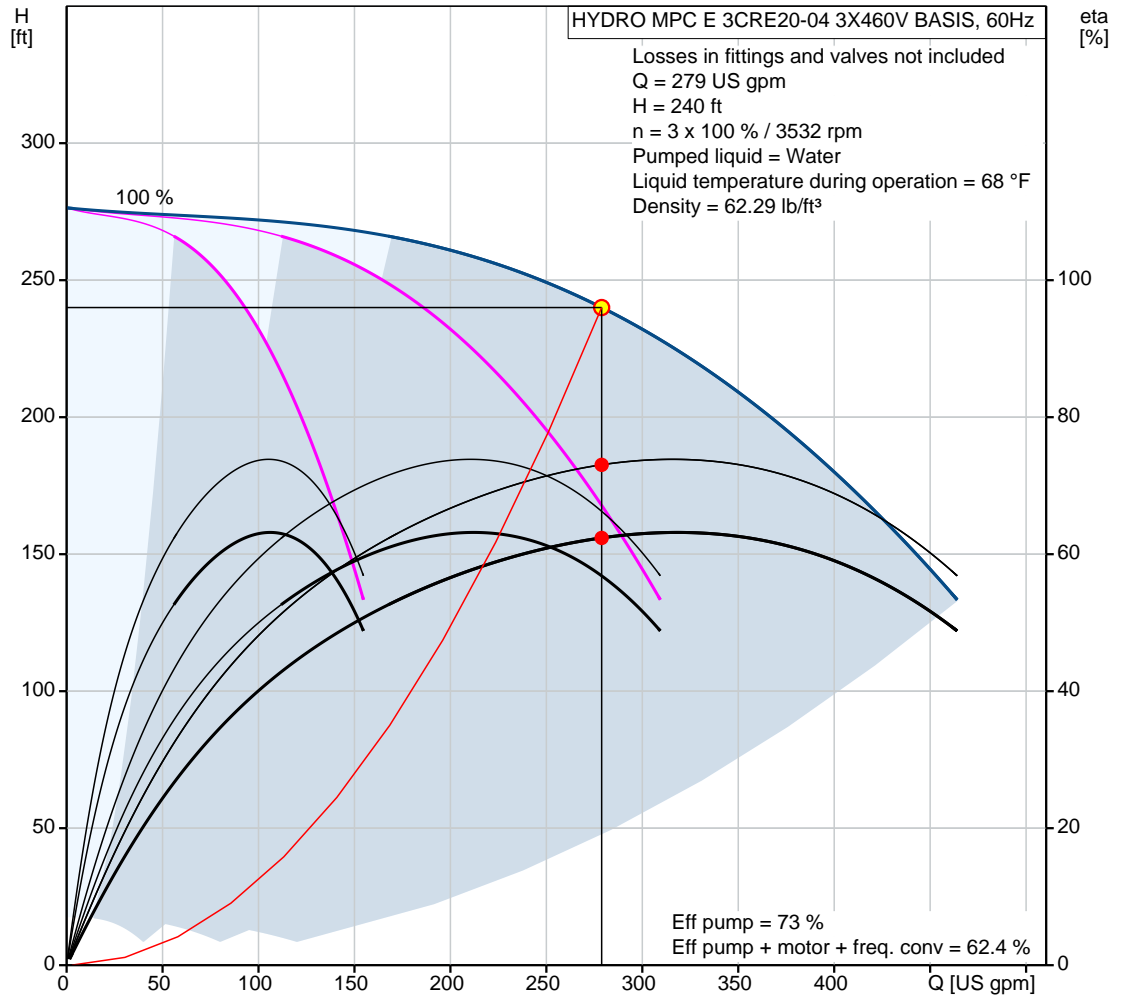

Description	Value
General information:	
Product name:	HYDRO MPC E 3CRE20-04 3X460V BASIS
Product No.:	95055172
EAN:	5700836977457
	5700836977457
Technical:	
Actual calculated flow:	279 US gpm
Max flow:	453 US gpm
Max flow system:	453 US gpm
Resulting head of the pump:	240 ft
Head max:	274.3 ft
Impellers main:	4
Main pump name:	CRE20-04
Main pump Number:	96541384
Number of pumps:	3
Non-ret. valve:	at discharge side
Installation:	
Maximum operating pressure:	232.06 psi
Maximum permissible inlet pressure:	145.04 psi
Flange standard:	ANSI
Pump inlet:	102
Pump outlet:	102
Pressure stage:	CL 150
Liquid:	
Pumped liquid:	Water
Liquid temperature range:	32 .. 140 °F
Selected liquid temperature:	68 °F
Density:	62.29 lb/ft ³
Electrical data:	
Power (P2) main pump:	10 HP
Main frequency:	60 Hz
Rated voltage:	3 x 3X460-480V, 60 Hz
Starting main:	electronically
Rated current of system:	37.8 A
Enclosure class (IEC 34-5):	UL Type 3R/12
Controls:	
Control type:	E
Operation unit:	CU 352
Tank:	
Diaphragm tank:	No
Others:	
Net weight:	961 lb
Language:	EN
Product range:	NAMREG
Configuration file Hydro MPC:	95043552
Country of origin:	US
Custom tariff no.:	8413.70.2040

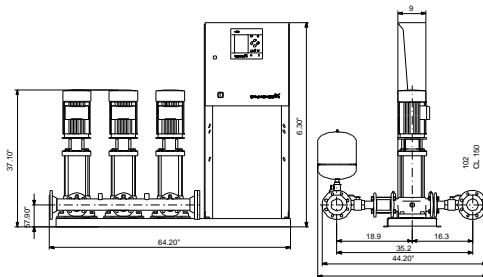
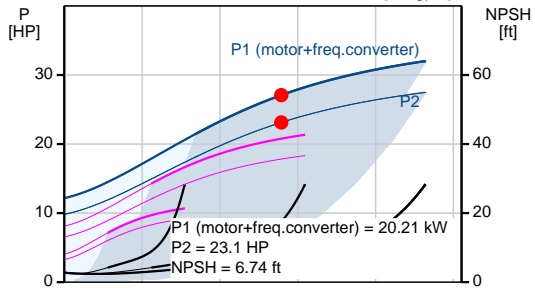
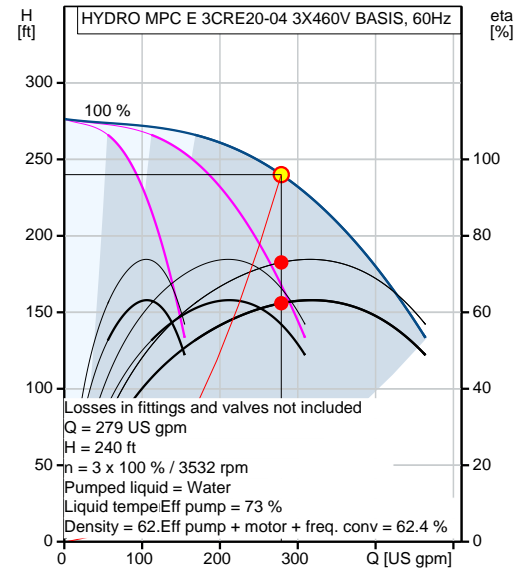

95055172 HYDRO MPC E 3CRE20-04 3X460V BASIS 60 Hz

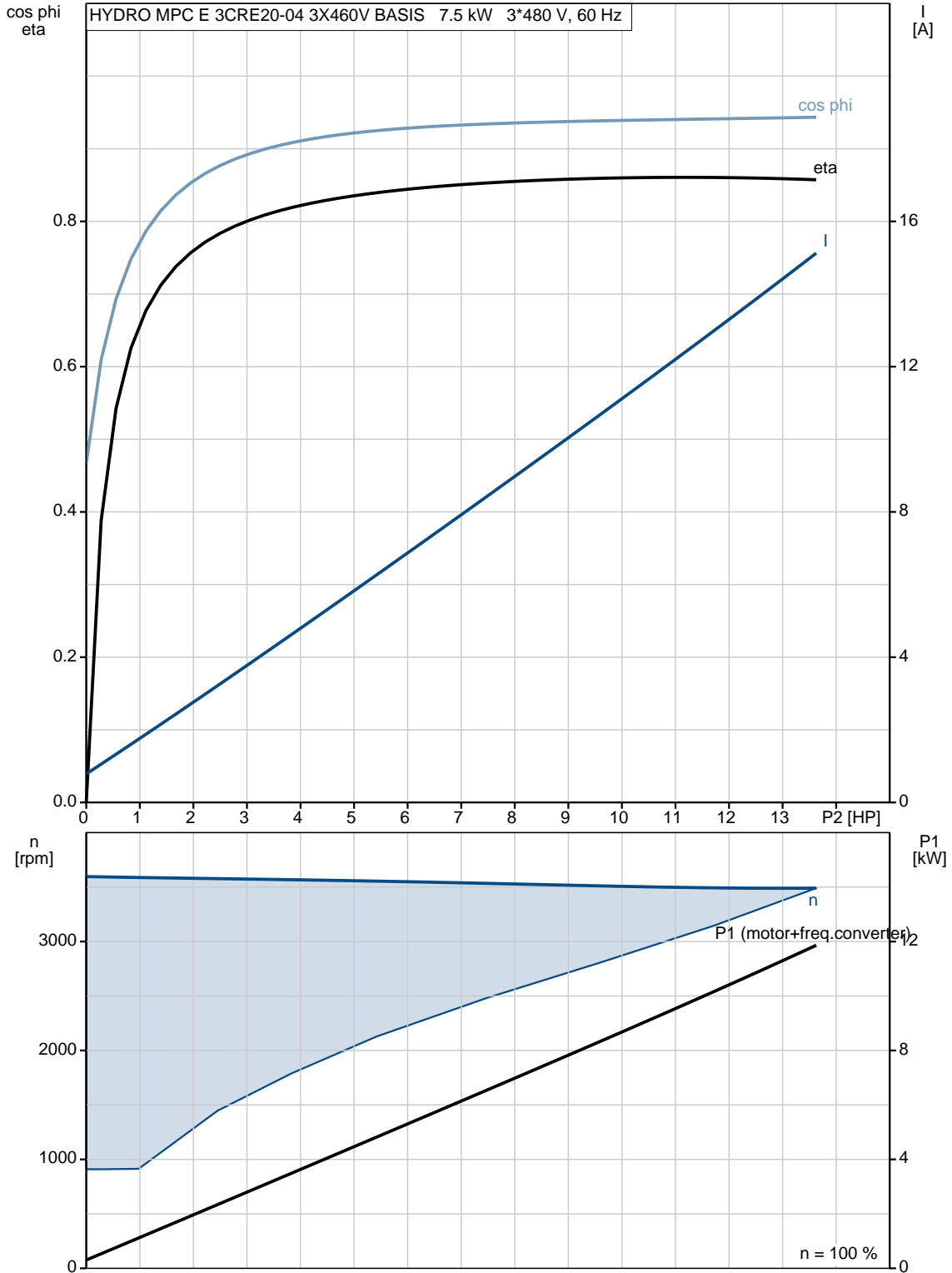



Company name: Hurley Engineering
Created by:
Phone:

Date: 3/20/2020

95055172 HYDRO MPC E 3CRE20-04 3X460V BASIS 60 Hz

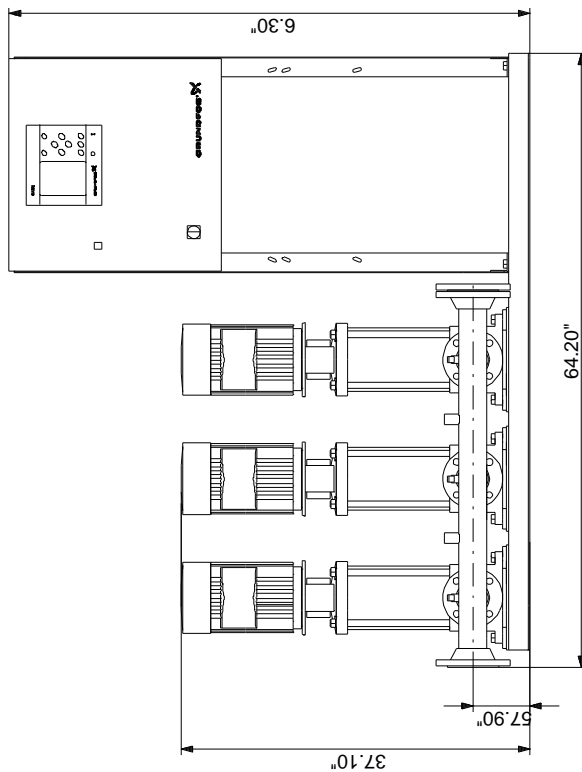
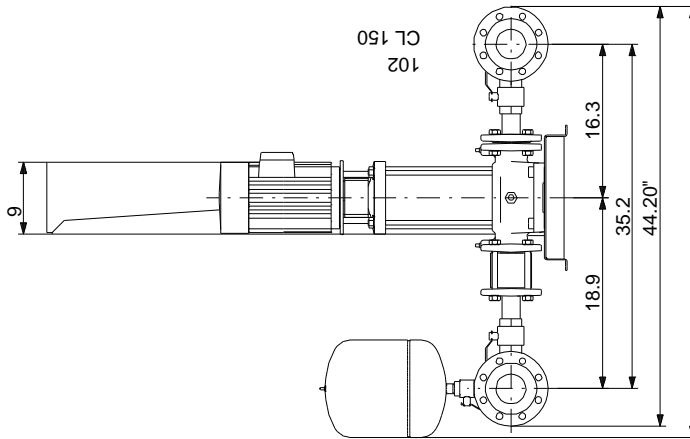

Note! All units are in [in] unless otherwise stated.
Disclaimer: This simplified dimensional drawing does not show all details.