

Count	Description
1	<p>HYDRO MPC E 3CRE32-2-1 3x460V 60HZ CAT</p>  <p>Product photo could vary from the actual product</p> <p>Product No.: 95058732</p> <p>Pressure booster system supplied as compact packaged assembly certified and listed by UL (Category QCZJ - Packaged Pumping Systems) for conformance to U.S. and Canadian Standards.</p> <p>All pumps are speed-controlled. Each pump is equipped with an integrated variable frequency drive motor (MLE motor).</p> <ul style="list-style-type: none">- Hydro MPC-E maintains constant pressure through continuous adjustment of the speed of the pumps.- The system performance is adapted to the demand through cutting in/out the required number of pumps and through parallel control of the pumps in operation.- Pump changeover is automatic and depends on load, operating hours and fault.- All pumps in operation will run at equal speed. <p>The system consists of these parts:</p> <ul style="list-style-type: none">- 3 vertical multistage centrifugal pumps, type CRE32-2-1.- Pump rotating parts in contact with the pumped liquid are made of ANSI 304 stainless steel as standard and ANSI 316 stainless steel as an option. <p>Pump bases and pump heads are made of cast iron (Class 30) as standard and ANSI 316 stainless steel as an option.</p> <p>The pumps are equipped with the service-friendly cartridge type mechanical shaft seal HQQE (SiC/SiC/EPDM).</p> <ul style="list-style-type: none">- Suction manifold and discharge manifold made of 316 stainless steel.- Base frame made of 304 stainless steel.- One non-return valve (check valve), and two isolating valves for each pump.- Adapter with isolating valve for connection of diaphragm tank.- Pressure gauge and pressure transducer on each suction and discharge manifold. <p>Dry-running protection is standard with use of pressure transducer on suction manifold.</p> <ul style="list-style-type: none">- Control MPC in a NEMA 4 steel control panel enclosure including main disconnect switch, all required fuses, motor protection, switching equipment and microprocessor-controlled CU 351. <p>Diaphragm tank is available as an accessory.</p> <p>Pump operation is controlled by Control MPC with the following features/functions:</p> <ul style="list-style-type: none">-



Company name: Hurley Engineering
Created by:
Phone:

Date: 3/20/2020

Count	Description
	<p>Advanced multi-pump controller (CU 351), specifically designed to control parallel operation of multiple pumps</p> <ul style="list-style-type: none"> - PID controller with adjustable PI parameters (Kp + Ti) - Constant pressure at setpoint, independent of inlet pressure - Stop function (no flow shutdown) - Automatic cascade control of pumps for optimum efficiency. - Selection of min. time between start/stop, automatic pump changeover and pump priority - Automatic pump test function to prevent idle pumps from seizing up - Standby pump allocation capability - Redundant primary sensor capability - Manual operation - Proportional pressure control - Forced pump changeover - Clock program - Soft pressure build-up - External setpoint influence (via analog input) - Emergency run (via digital input) - Password protection - Possibility of digital remote-control functions (via digital inputs): <ul style="list-style-type: none"> • system on/off • max., min. or user-defined duty • up to 6 alternative setpoints. <ul style="list-style-type: none"> - Digital inputs and outputs can be configured individually - Pump and system monitoring functions: • minimum and maximum limits of current value (flow, level, temp., etc.) • inlet pressure • motor protection • high system pressure • low system pressure • pump curve data loaded into controller to provide end of curve protection • alarm log with the previous 24 warnings/alarms <ul style="list-style-type: none"> - Display and indication functions: • 320 x 240 pixels graphical display with backlight • green indicator light for operating indications and red indicator light for fault indications • potential-free changeover contacts for operation and fault. <ul style="list-style-type: none"> - Grundfos bus communication with optional gateway connections for LON, Modbus, Profibus, BACnet, GSM - Ethernet connection (built-in web server) <p>Pre-fabricated and tested packaged pump system including pumps, piping, and wiring complete with Control MPC.</p> <p>Flow media: Water System pressure max.: 232.06 psi Flow (Plant): 633 US gpm Flow without one stand-by pump acc. DIN 1988/T5: 633 US gpm Flow (Pump): 353 US gpm Head: 148.6 ft Mains supply: 3X460-480V, 60 Hz Nom. current of plant: 29.7 A Number of main pumps: 3 Nominal power: 7.51 HP Suction port: 152 Discharge port: 152</p>



Company name: Hurley Engineering
Created by:
Phone:

Date: 3/20/2020

Count	Description
	Net weight: 1120 lb



Company name: Hurley Engineering
Created by:
Phone:

Date: 3/20/2020

95058732 HYDRO MPC E 3CRE32-2-1 3x460V 60HZ CAT 60 Hz

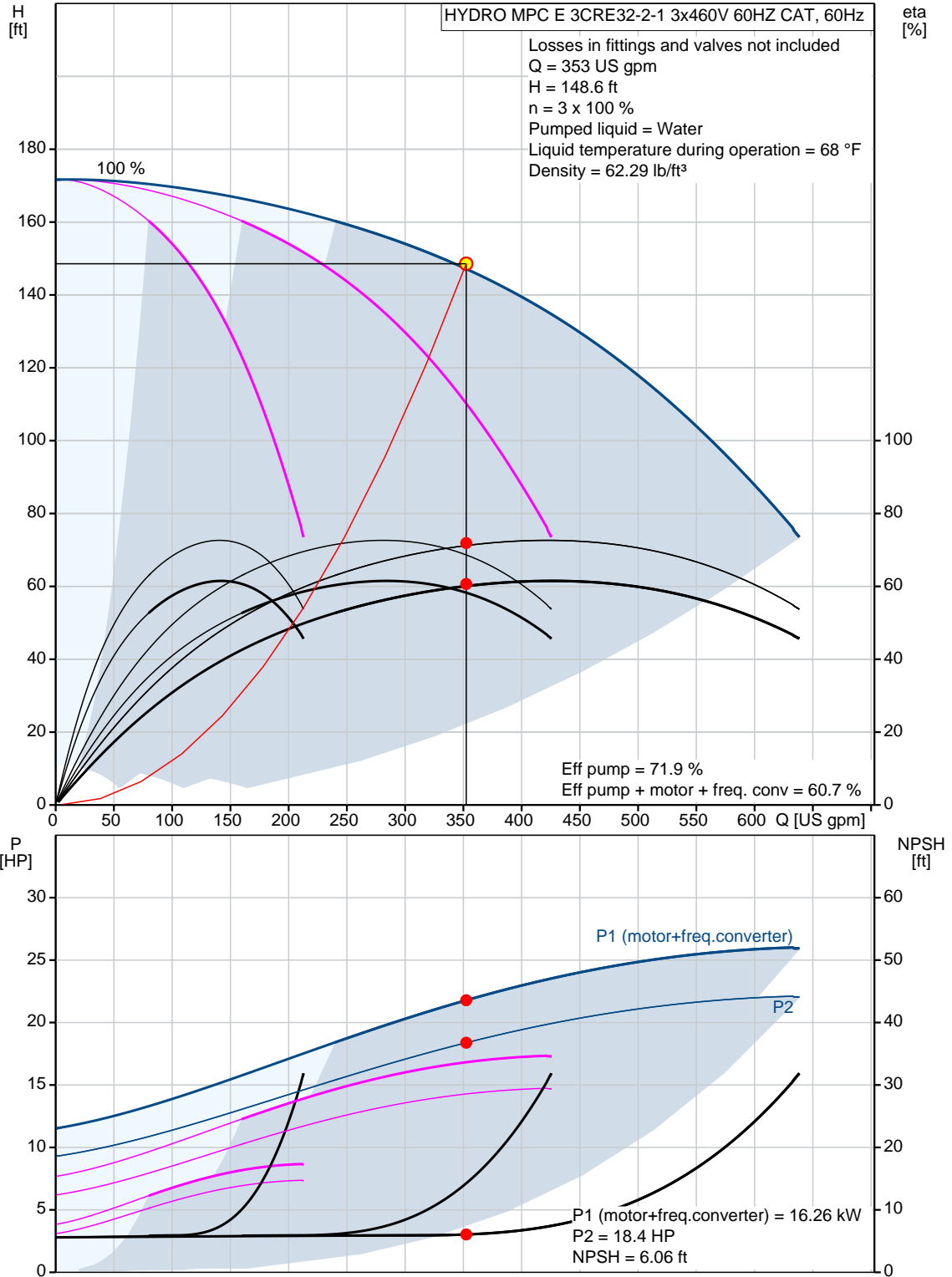

Description	Value
General information:	
Product name:	HYDRO MPC E 3CRE32-2-1 3x460V 60HZ CAT
Product No.:	95058732
EAN:	5710629505217
	5710629505217
Technical:	
Actual calculated flow:	353 US gpm
Max flow:	633 US gpm
Max flow system:	633 US gpm
Resulting head of the pump:	148.6 ft
Head max:	168 ft
Impellers main:	2
Main pump name:	CRE32-2-1
Main pump Number:	97765469
Number of pumps:	3
Non-ret. valve:	at discharge side
Installation:	
Maximum operating pressure:	232.06 psi
Maximum permissible inlet pressure:	58.02 psi
Flange standard:	ANSI
Pump inlet:	152
Pump outlet:	152
Pressure stage:	CL 150
Liquid:	
Pumped liquid:	Water
Maximum liquid temperature:	140 °F
Selected liquid temperature:	68 °F
Density:	62.29 lb/ft ³
Electrical data:	
Power (P2) main pump:	7.51 HP
Main frequency:	60 Hz
Rated voltage:	3 x 3X460-480V, 60 Hz
Rated current of system:	29.7 A
Enclosure class (IEC 34-5):	UL Type 3R/12
Controls:	
Control type:	E
Operation unit:	CU 352
Tank:	
Diaphragm tank:	No
Others:	
Net weight:	1120 lb
Language:	EN
Product range:	NAMREG
Configuration file Hydro MPC:	98272054
Country of origin:	US
Custom tariff no.:	8413.70.2040

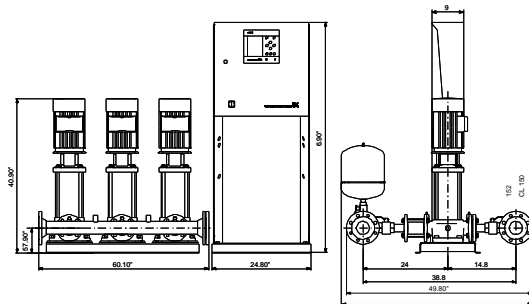
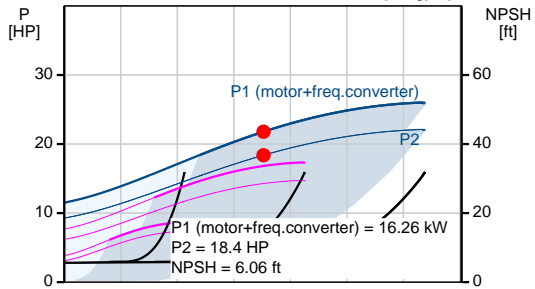
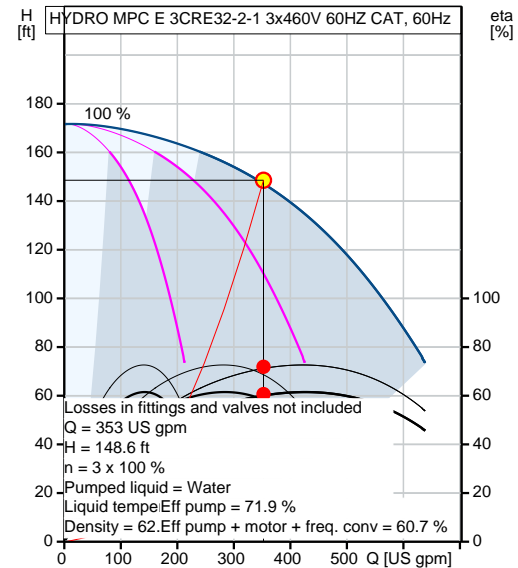

95058732 HYDRO MPC E 3CRE32-2-1 3x460V 60HZ CAT 60 Hz

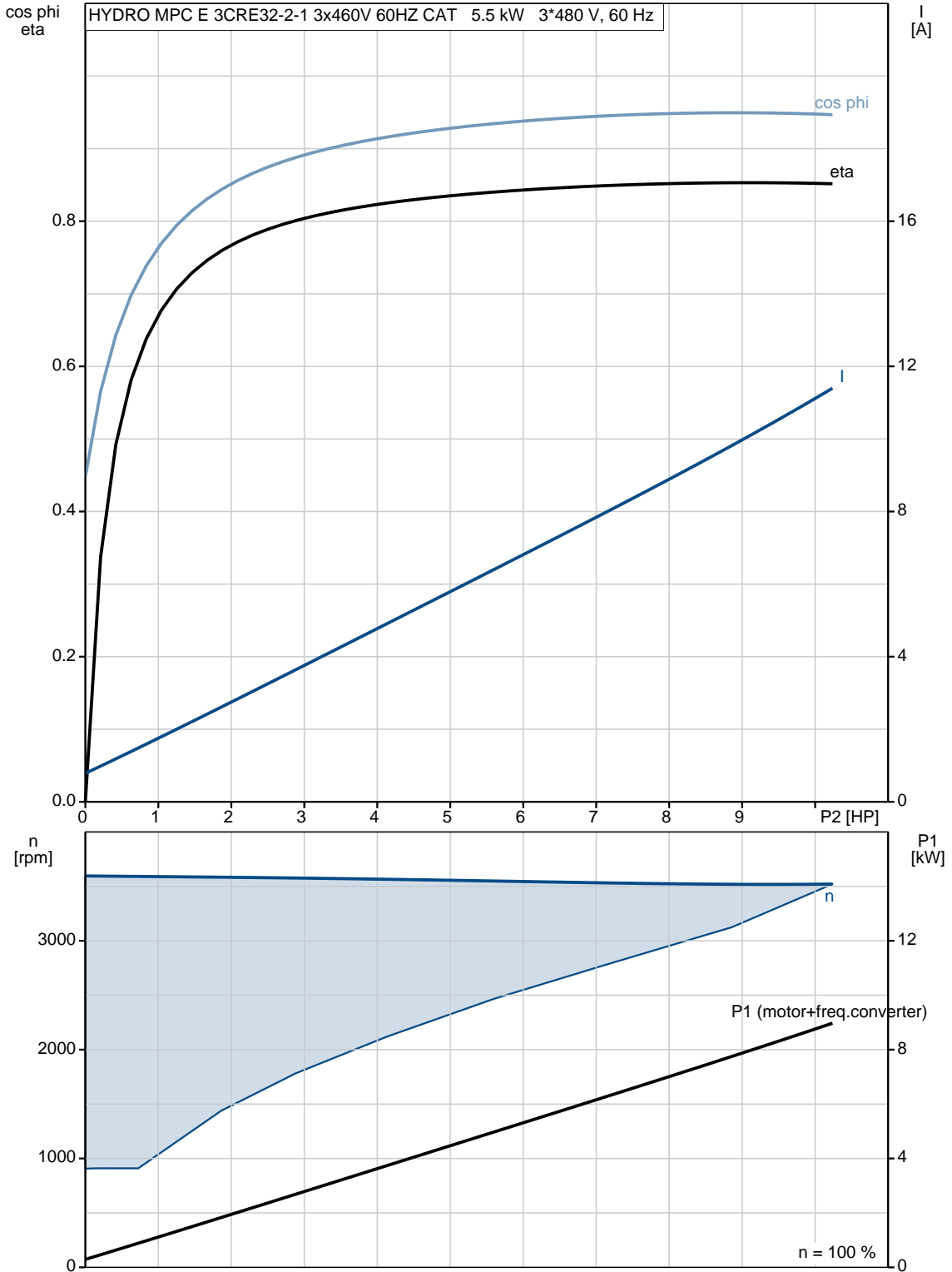



Company name: Hurley Engineering
Created by:
Phone:

Date: 3/20/2020

95058732 HYDRO MPC E 3CRE32-2-1 3x460V 60HZ CAT 60 Hz

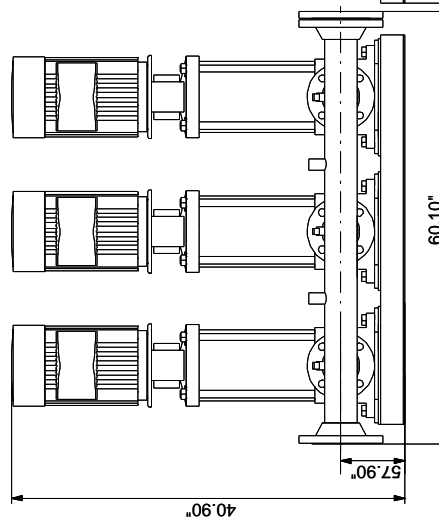
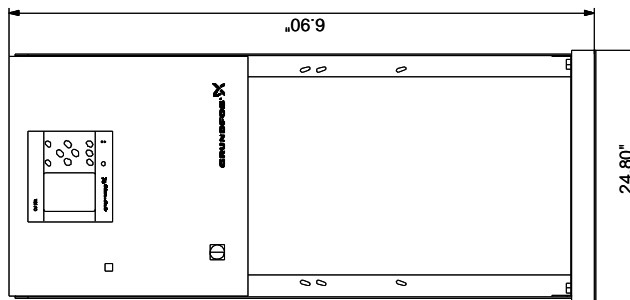
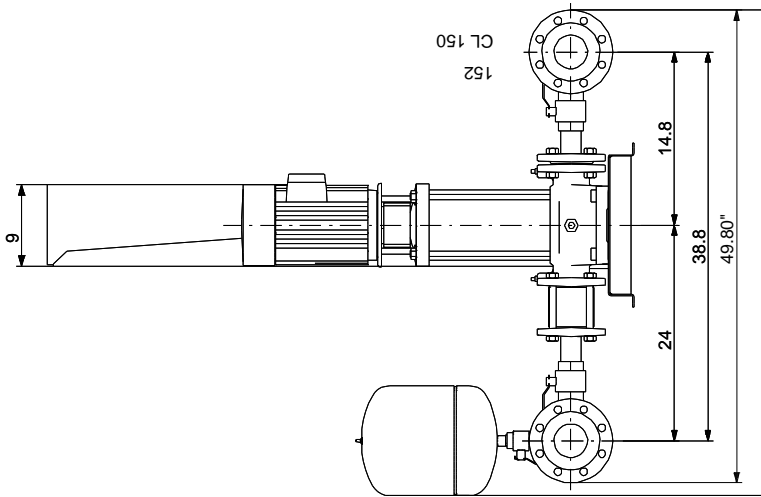

Note! All units are in [in] unless otherwise stated.
Disclaimer: This simplified dimensional drawing does not show all details.