

Pump Performance Datasheet

Customer :	Quote Number / ID :	1143354
Customer ref. / PO :	Model :	20955-4P-5HP VLSE
Tag Number : Hurley Engineering	Stages :	1
Service : HYDRONIC	Based on curve number :	VLSE_20955_4P_5HP Rev 0.0
Quantity : 1	Basic model number :	-
	Date last saved :	04/02/2020 3:37 PM

Operating Conditions		Liquid	
Flow, rated	: 128.4 USgpm	Liquid type	: Cold Water
Differential head / pressure, rated (requested)	: 76.91 ft	Additional liquid description	:
Differential head / pressure, rated (actual)	: 76.91 ft	Solids diameter, max	: 0.00 in
Suction pressure, rated / max	: 0.00 / 0.00 psi.g	Solids concentration, by volume	: 0.00 %
NPSH available, rated	: Ample	Temperature, max	: 68.00 deg F
Frequency	: 60 Hz	Fluid density, rated / max	: 1.000 / 1.000 SG
		Viscosity, rated	: 1.00 cP
		Vapor pressure, rated	: 0.34 psi.a
Performance		Material	
Speed, rated	: 1769 rpm	Material selected	: Cast Iron
Speed, maximum	: 1769 rpm		
Speed, minimum	: 450 rpm	Pressure Data	
Impeller diameter, rated	: 9.48 in	Maximum working pressure	: 40.51 psi.g
Efficiency	: 58.64 %	Maximum allowable working pressure	: 175.0 psi.g
NPSH required / margin required	: 14.75 / 0.00 ft	Maximum allowable suction pressure	: 250.0 psi.g
nq (imp. eye flow) / S (imp. eye flow)	: 15 / 53 Metric units	Hydrostatic test pressure	: 263.0 psi.g
MCSF	: 39.03 USgpm		
Head maximum, rated speed	: 93.61 ft	Driver & Power Data (@Max density)	
Head rise to shutoff	: 21.35 %	Motor sizing specification	: Max power (non-overloading)
Flow, best eff. point	: 128.4 USgpm	Margin over specification	: 0.00 %
Flow ratio, rated / BEP	: 100.00 %	Service factor	: 1.00
Speed ratio (rated / max)	: 100.00 %	Power, hydraulic	: 2.49 hp
Head ratio (rated speed / max speed)	: 100.00 %	Rated power (based on duty point)	: 4.25 hp
Cq/Ch/Ce/Cn [ANSI/HI 9.6.7-2010]	: 1.00 / 1.00 / 1.00 / 1.00	Max power (non-overloading)	: 4.66 hp
Selection status	: Acceptable	Nameplate motor rating	: 5.00 hp / 3.73 kW (Fixed)
Energy Indexes			
PEI (VL)	: 0.42		
ER (VL)	: 58		

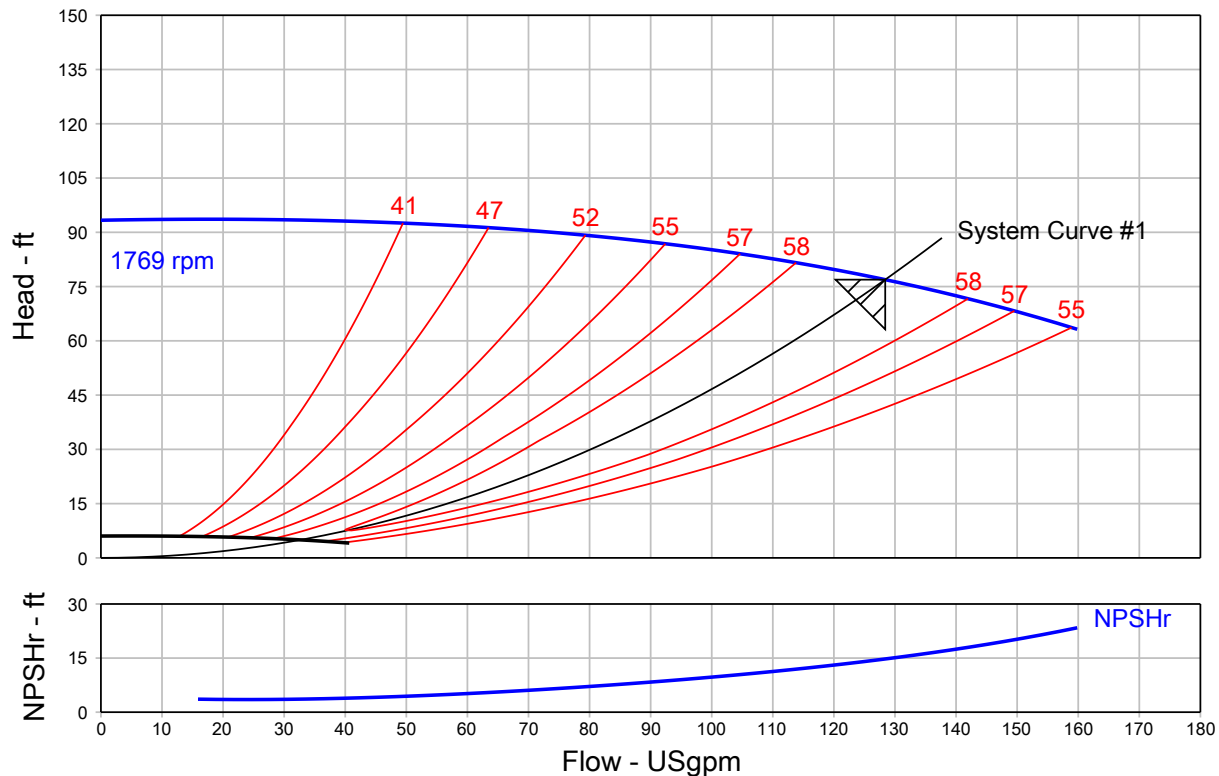

Grundfos Series VLSE - Split Coupled Vertical In-Line with Integrated VFD

QUOTE NUMBER / ID 1143354	UNIT TAG Hurley Engineering	QUANTITY 1
	SERVICE HYDRONIC	
REPRESENTATIVE	SUBMITTED BY	DATE
ENGINEER	APPROVED BY	DATE
CONTRACTOR	ORDER #	DATE



VLSE 20955-4P-5HP
1800 rpm

Part Number N/A

Conditions of Service		Pump Data		Motor Data	
Flow	128.4 USgpm	Impeller Diameter	9.48 in	Motor HP	5 HP
Head	76.91 ft	Efficiency	58.64 %	BHP	4.25
Liquid	Cold Water	Suction	2 in.	Enclosure	TEFC
Temperature	68.00 deg F	Discharge	2 in.	Voltage	460 V
NPSHr	14.75 ft	PEI (VL)	0.42	Phase	3 Phase
Viscosity	1.00 cP	ER (VL)	58	Cycle	60
Specific Gravity	1.000 SG			Frame Size	182TC

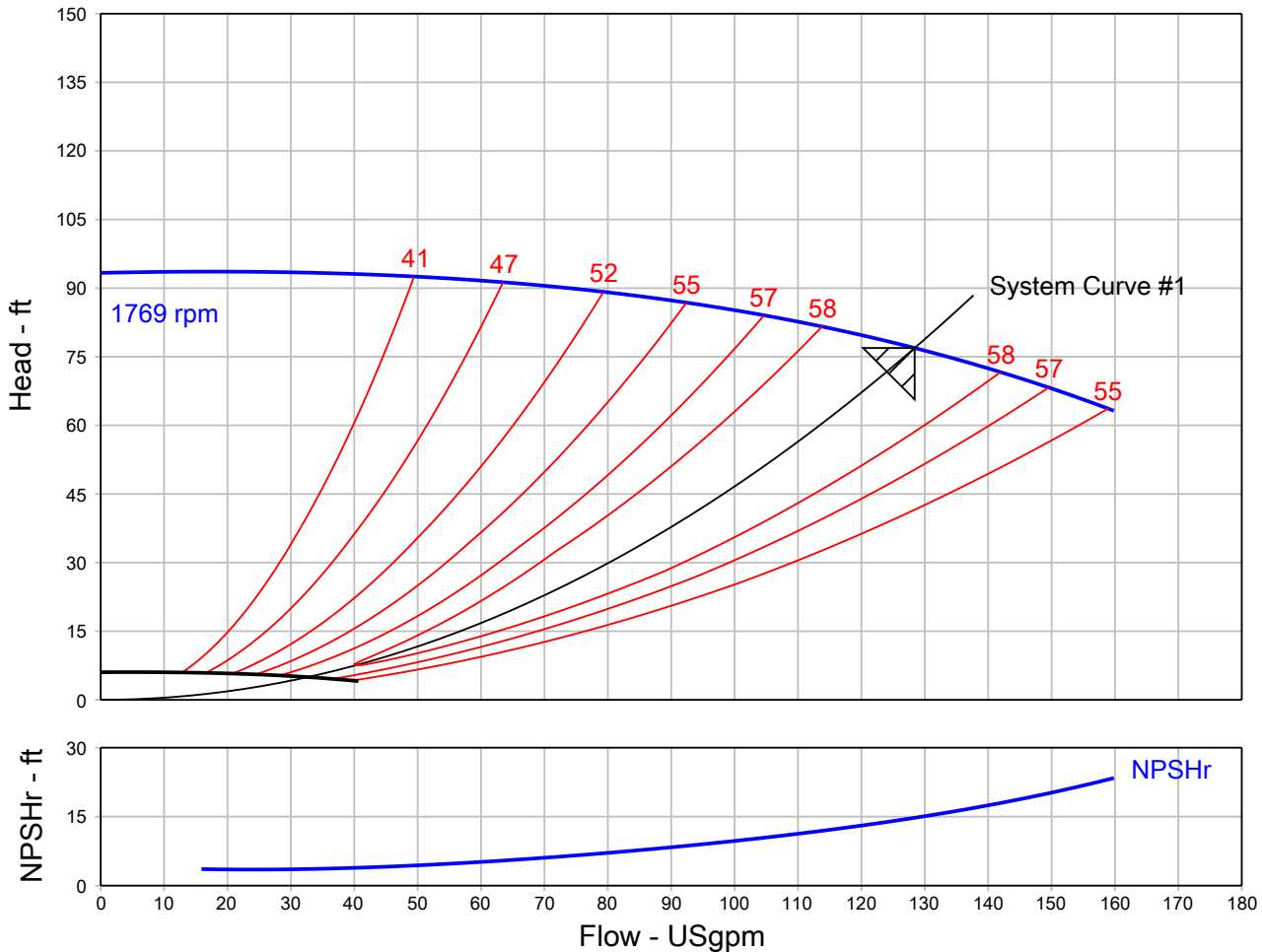

Grundfos Series VLSE - Split Coupled Vertical In-Line with Integrated VFD



NOT FOR CONSTRUCTION, unless certified and referenced on order

Units	Frame	S x D	AG (Max)	DC	DD	DE	E	P (Max)	X	YY
inches	182TC	2 X 2	28.50	6.00	4.88	6.25	1.50	13.30	9.00	9.00

Grundfos Series VLSE - Split Coupled Vertical In-Line with Integrated VFD

QUOTE NUMBER / ID 1143354	UNIT TAG Hurley Engineering	VLSE 20955-4P-5HP
----------------------------------	------------------------------------	--------------------------

MATERIALS OF CONSTRUCTION			
PART	MATERIAL	PART	MATERIAL
Rotation Options	Clockwise	Impeller Washer	S.S., AISI-303
Base/Stand Type	No Stand Provided	Impeller Key	S.S., AISI-303
Connections	125# ANSI	Sleeve Material	Bronze, III932, C89835 or No Sleeves
Coupling Options	Rigid Radially Split Coupling	Wear Ring Type	Case Wear Ring
Wear Ring Material	NiAl-Bronze, ASTM-B148, C95500	Pump Coatings	Standard Paint
Seal Type	Type 21	Seal Material	Ceramic/Carbon/Buna
Casing	Cast Iron, ASTM-A48, CL 30	O-Rings	Buna N
Motor Shaft	Steel, AISI 1045 or S.S	Seal Flush Options	External Flush, plastic tubing
Backplate/Seal Plate	Cast Iron, ASTM-A48, CL 30	Gaskets	Vegetable Fiber
Motor Bracket	Cast Iron, ASTM-A48, CL 30	Casing Bolts	Steel, Grade 5
Impeller	Stainless Steel, AISI-304	Impeller Cap Screw	S.S., AISI-303

* All materials based on STANDARD configuration

Pump Performance Curve

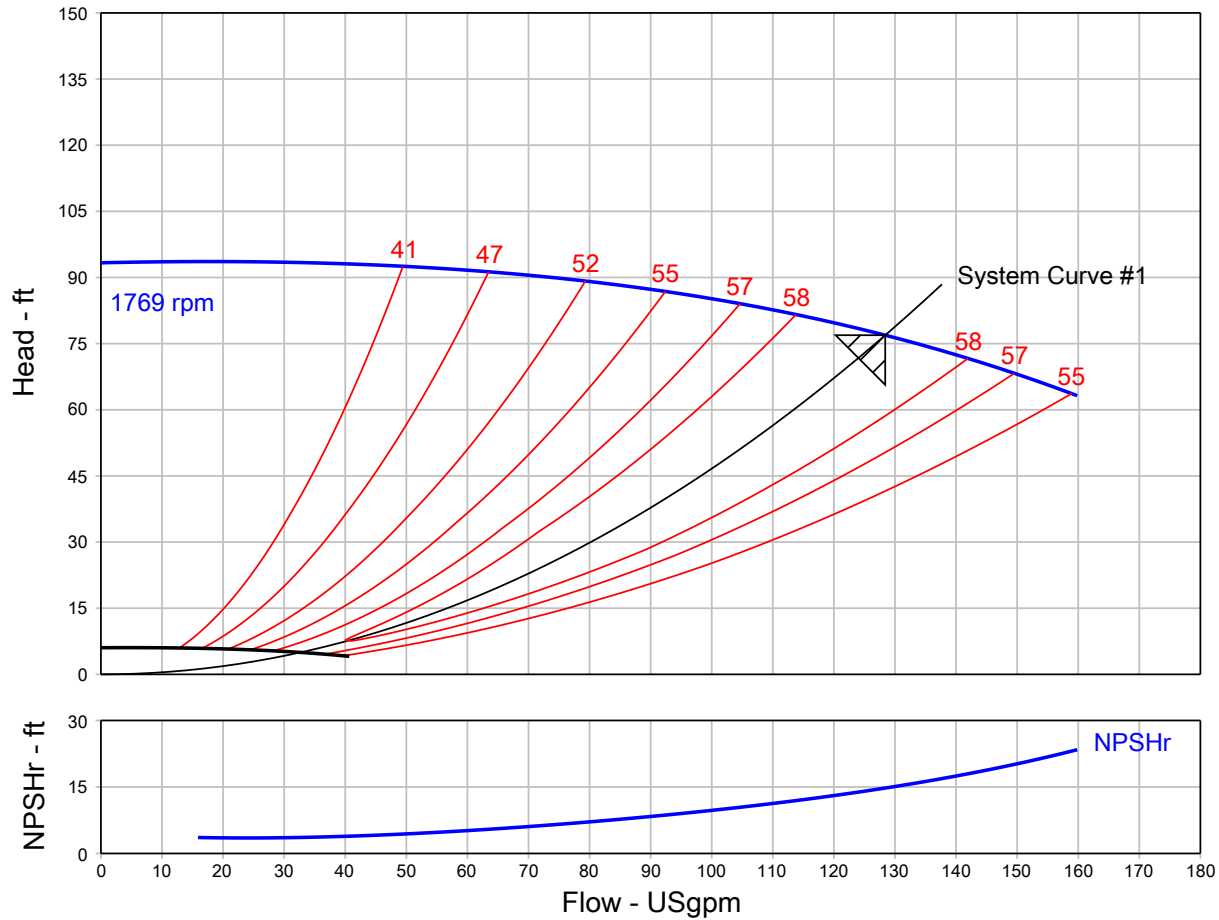

Customer :	Model :	20955-4P-5HP VLSE
Customer ref. / PO :	Stages :	1
Tag Number : Hurley Engineering	Speed, rated :	1769 rpm
Service : HYDRONIC	Based on curve number :	VLSE_20955_4P_5HP Rev 0.0
Quantity : 1	Efficiency :	58.64 %
Quote Number / ID : 1143354	Rated power (based on duty point) :	4.25 hp
Date last saved : 04/02/2020 3:37 PM	NPSH required :	14.75 ft
Flow, rated : 128.4 USgpm	Viscosity :	1.00 cP
Differential head / pressure, rated : 76.91 ft	Cq/Ch/Ce/Cn [ANSI/HI 9.6.7-2010] :	1.00 / 1.00 / 1.00 / 1.00
Fluid density, rated / max : 1.000 / 1.000 SG	Impeller diameter, rated :	9.48 in
	PEI (VL) :	0.42
	ER (VL) :	58

Pump Performance Curve

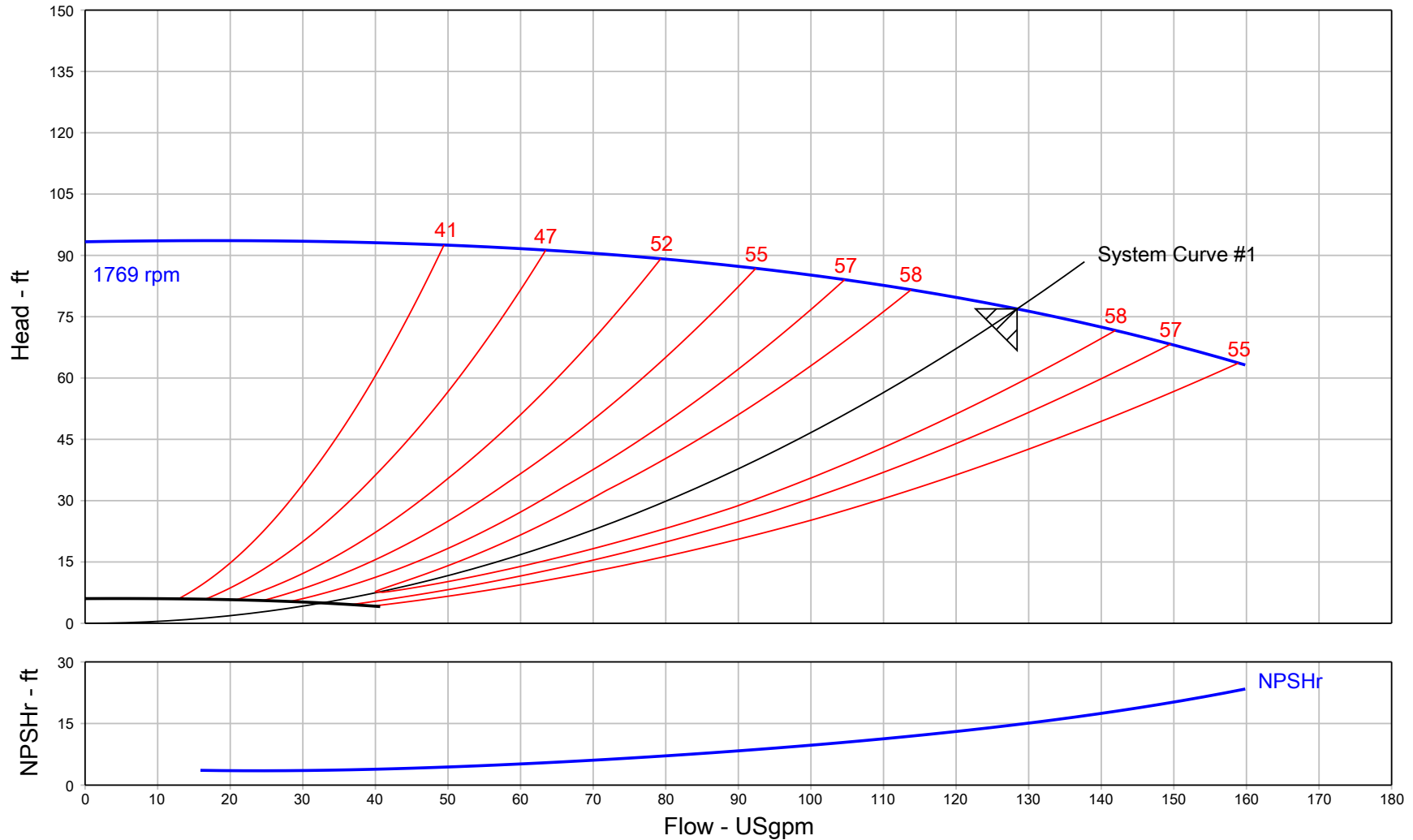

Project name : VLSE project	Tag Number : Hurley Engineering	Flow, rated : 128.4 USgpm
Consulting engineer :	Service : HYDRONIC	Differential head / pressure, rated : 76.91 ft
Customer :	Model : 20955-4P-5HP VLSE	Rated power (based on duty point) : 4.25 hp
Customer ref. / PO :	Quantity : 1	Max power (non-overloading) : 4.66 hp
Quote Number / ID : 1143354	Quoted By (Sales Office) : HURLEY ENGINEERING COMPANY	Efficiency : 58.64 %
Date last saved : 04/02/2020 3:37 PM	Quoted By (Sales Engineer) : Steven Leingang	Impeller diameter, rated : 9.48 in
Based on curve number : VLSE_20955_4P_5HP Rev 0.0	Stages : 1	PEI (VL) : 0.42
	Speed, rated : 1769 rpm	ER (VL) : 58

Multi-Speed Performance Curve

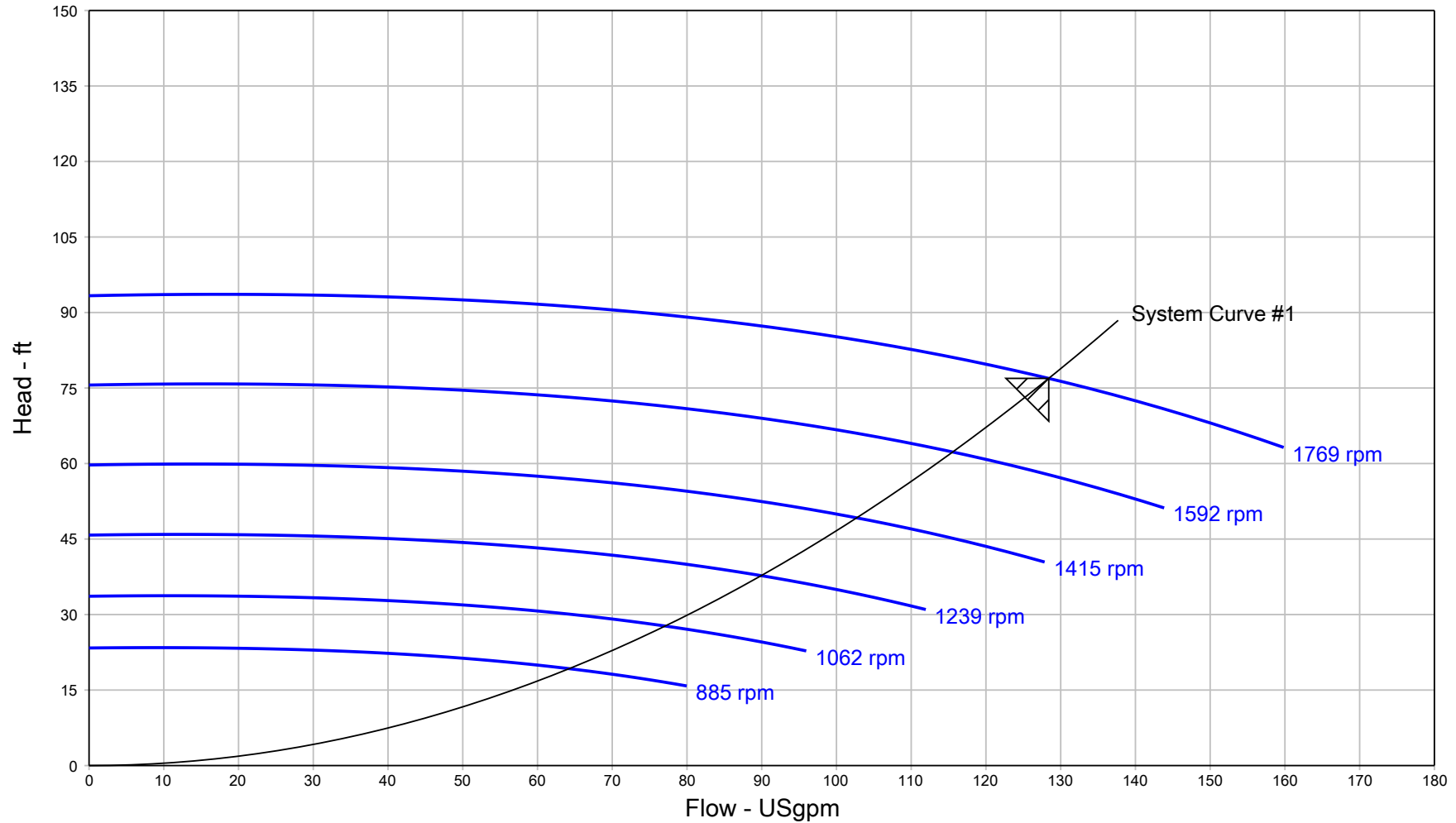

Project name	: VLSE project	Tag Number	: Hurley Engineering	Speed, rated	: 1769 rpm
Consulting engineer	:	Service	: HYDRONIC	Flow, rated	: 128.4 USgpm
Customer	:	Model	: 20955-4P-5HP VLSE	Differential head / pressure, rated	: 76.91 ft
Customer ref. / PO	:	Quantity	: 1	Fluid density, rated / max	: 1.000 / 1.000 SG
Quote Number / ID	: 1143354	Quoted By (Sales Office)	: HURLEY ENGINEERING COMPANY	Viscosity	: 1.00 cP
Date last saved	: 04/02/2020 3:37 PM	Quoted By (Sales Engineer)	: Steven Leingang	Cq/Ch/Ce/Cn [ANSI/HI 9.6.7-2010]	: 1.00 / 1.00 / 1.00 / 1.00
		Stages	: 1	Based on curve number	: VLSE_20955_4P_5HP
				Rev 0.0	

Construction Datasheet

Project name	: VLSE project	Tag Number	: Hurley Engineering
Consulting engineer	:	Service	: HYDRONIC
Customer	: HURLEY ENGINEERING COMPANY	Model	: 20955-4P-5HP VLSE
Customer ref. / PO	:	Quantity	: 1
Quote Number / ID	: 1143354	Quoted By (Sales Office)	: HURLEY ENGINEERING COMPANY
Date last saved	: 04/02/2020 3:37 PM	Quoted By (Sales Engineer)	: Steven Leingang

Construction				Motor Information	
Nozzle	Size (in.)	Nozzle Configuration	Pos'n	Manufacturer	: Grundfos MLE
Suction	2	125# ANSI	-	Frame Size	: 182TC
Discharge	2	125# ANSI	-	Power	: 5.00 hp

Orientation / Configuration	: Vertical	RPM	: 1800 rpm
Rotation	: Clockwise	Enclosure	: TEFC
Wear Ring Configuration	: Single - Case	Operating Power Supply	: 460/3/60
Discharge Elbow Size	: -	Efficiency	: IE5
Subplate	: -	Service factor	: 1.15
Sump Depth (feet)	: -	Motor Application	: Intergrated Variable Frequency Drive
Bearing Frame	: -	Motor Options/Accessories	: -
Bearing Frame Foot	: -	Cord Length (feet)	: -
Bearing Type (Radial/Thrust)	: -		
Bearing Lubrication	: Regreasable		
Thrust Bearing	: -		
Intermediate Bearing	: -		
Lower Bearing	: -		
Bearing Housing Accessories	: -		
PACO Construction code	: 28-20955-130268-25D2MS1		

Materials	
Case	: Cast Iron, ASTM A48 - Class 30
Motor Bracket	: Cast Iron, ASTM-A48, CL 30
Impeller	: Stainless Steel, AISI-304 (H304)
Impeller Cap Screw and Washer	: Stainless Steel, AISI-303
Impeller Key	: Stainless Steel, AISI 316
Case wear ring	: Tin Bronze, ASTM B584-90500 (B18)
Impeller wear ring	: -
Pump Shaft	: Stainless Steel, AISI-303
Sleeve	: -
Line Shaft	: -
Column	: -
Discharge Pipe	: -
Discharge Elbow	: -
Suction Elbow	: -
Subplate	: -
Hardware	: Steel, Grade 5
O Rings	: Buna N
Pump Coatings	: Standard Manufacturers Paint

Baseplate, Coupling and Guard	
Baseplate	: Not Applicable
Drip Pan	: -
Coupling	: Rigid, Axial Split Coupling (aluminum) RASC1
Guard	: OSHA Approved

Seal & Packing Construction	
Sealing Method	: Single Seal, Type 21
Seal Material	: Buna Carbon Ceramic SS-Spring and Hardware
Packing Gland	: -
Lantern Ring	: -
Recirculation Lines	: Nylon Tubing with Brass Fittings

Weights (Approx.)	
Pump	: 119.0 lb
Baseplate	: -
Driver	: 68.26 lb
Estimated Shipping gross weight	: 187.3 lb

General Arrangement

Project name	: VLSE project	Tag Number	: Hurley Engineering
Consulting engineer	:	Service	: HYDRONIC
Customer	: HURLEY ENGINEERING COMPANY	Model	: 20955-4P-5HP VLSE
Customer ref. / PO	:	Quantity of pumps	: 1
Quote Number / ID	: 1143354	Quoted By (Sales Office)	: HURLEY ENGINEERING COMPANY
Date last saved	: 04/02/2020 3:37 PM	Quoted By (Sales Engineer)	: Steven Leingang

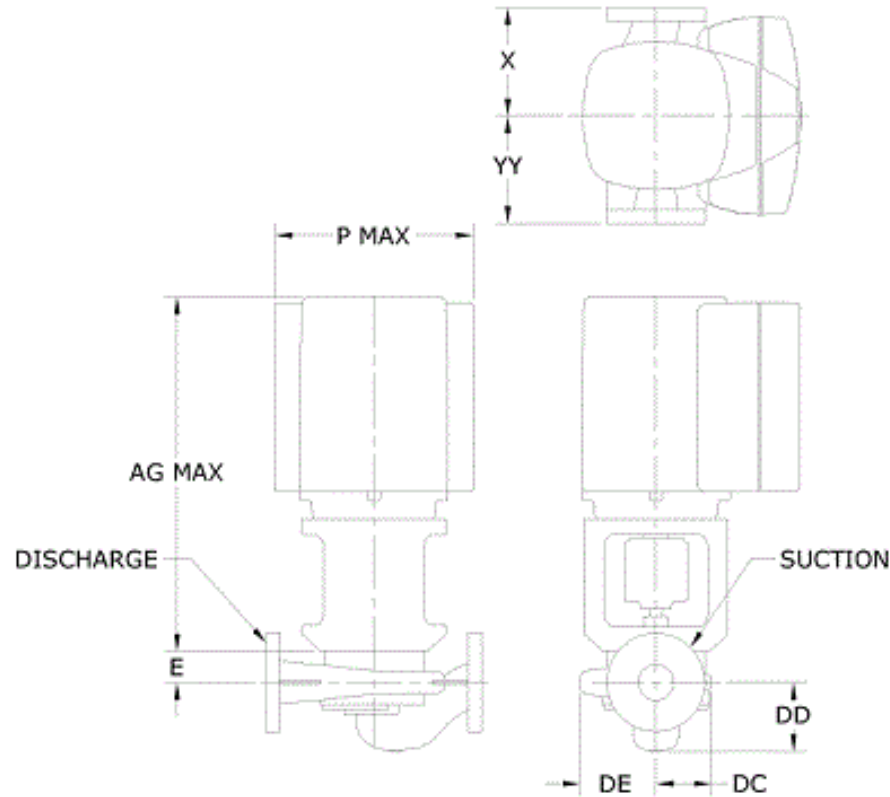

NOT FOR CONSTRUCTION, Unless certified and referenced on order

Units	Frame	S x D (in.)	AG (Max)	DC	DD	DE	E	P (Max)	X	YY	Weight ea
inches	182TC	2 X 2	28.50	6.00	4.88	6.25	1.50	13.30	9.00	9.00	187.3

Conditions of Service		Motor Data			
Flow: 128.4 USgpm	Fluid: Cold Water	HP: 5	Encl: TEFC	Phase: 3	Efficiency: IE5
TDH: 76.91 ft	Temp.: 68.00 deg F	RPM: 1800 rpm	Hz: 60	Voltage: 460	S.F.: 1.15

Grundfos VLSE Cross Section

Type VLSE, cross section and parts list

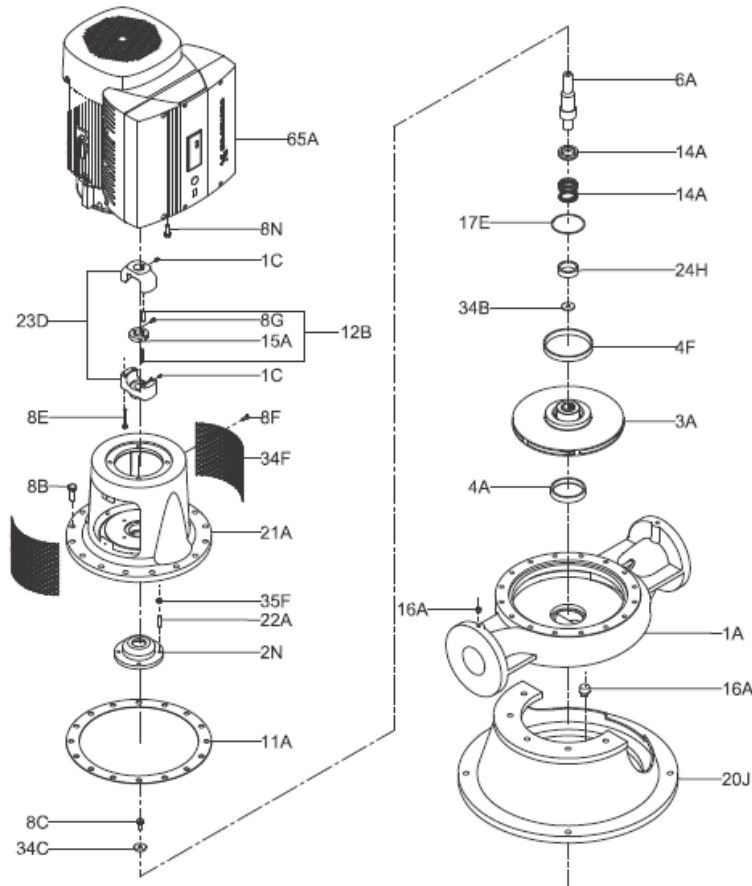

TM06 1076 1514

Pos.	Description	Pos.	Description
1A	Volute	14A*	Seal assembly
1C	Set screw	15A	Locating ring
2N	Seal cap	16A	Pipe plug
3A*	Impeller	17E	Seal cap o-ring
4A*	Case wear ring	20J	Cast iron stand
4F	Balance ring	21A	Motor bracket
6A	Pump shaft	22A	Seal cap studs
8B	Volute screw	23D	Coupling halves
8C	Pump shaft screw	24H	Bushing
8E	Coupling screw	34B*	Impeller washer
8F	Coupling guard screw	34C	Pump shaft washer
8G	Locating ring screw	34F	Coupling guard
8N	Motor screw	35F	Seal cap nut
11A*	Volute gasket	65A	Motor
12B	Coupling key		

* Recommended spare parts