

HEADROOM REQUIRED

OPENING HEIGHT	VERTICAL HEADROOM	HORIZONTAL HEADROOM
THRU 8'-0"	20"	20"
OVER 8'-0" THRU 10'-0"	21"	21"
OVER 10'-0" THRU 14'-0"	21 1/2"	22"
OVER 14'-0" THRU 16'-0"	22"	23"
OVER 16'-0" THRU 18'-0"	22"	22"
OVER 18'-0" THRU 20'-0"	22"	22"

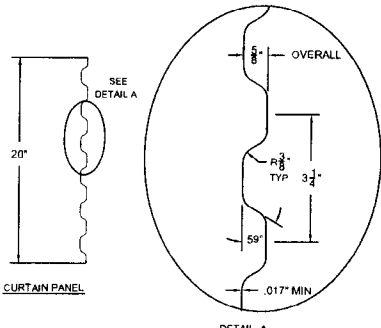

REVISIONS

REV	DESCRIPTION	DATE	APPROVAL
	DRAWING RELEASE	1-31-03	DM
A	GUIDE ATTACH AT TOE	11-13-03	DM
B	ADD GUIDE OPTION 3	4-13-04	DM
C	RETEST FOR FLORIDA	9-26-05	DM
D	REMOVED STONDRS. DATES	9-26-05	CS
E	ADDED T7 BRACKET OPTION	01-20-12	CS
F	ADDED CHARTED PSF VALUES	11-07-12	CS
G	REVISED CHARTED PSF VALUES DOWN TO 10 FT. REVISED HEADROOM CHART.	05-22-13	CS

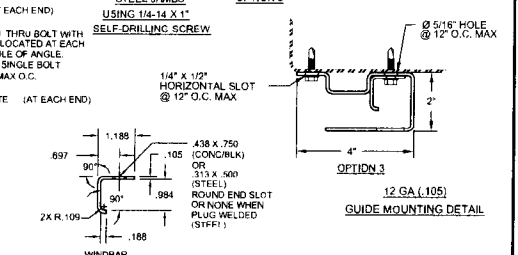
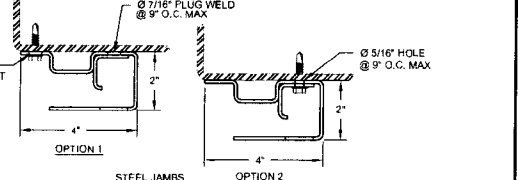
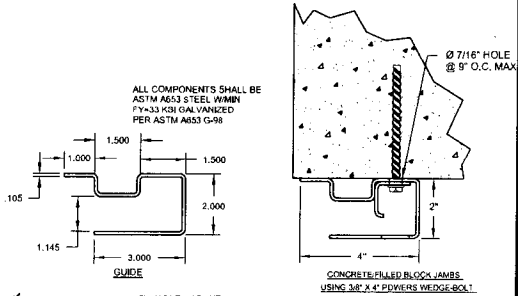
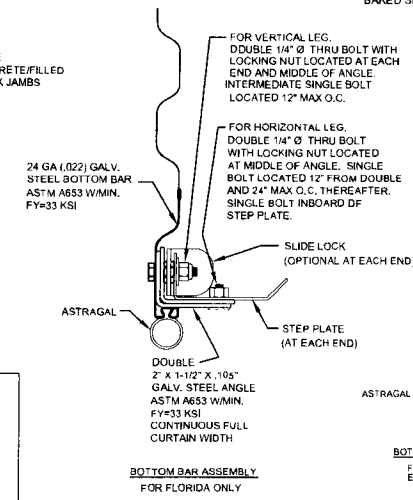

SIDE VIEW

INSIDE ELEVATION

WINDLOCK

MATERIAL: G90 GALV. ASTM A653 STRUCTURAL STEEL, GRADE 50, CLASS 1 MIN FY=50 KSI

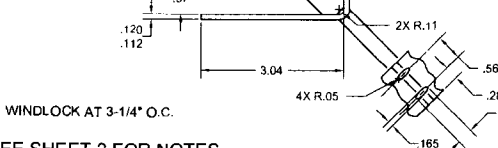

SEE SHEET 2 FOR NOTES

THESE CONFIDENTIAL DOCUMENTS SUBMITTED BY JANUS CONTAIN INFORMATION OF A PROPRIETARY NATURE AND MAY NOT BE REPRODUCED OR USED TO MANUFACTURE ANYTHING IN PART OR IN WHOLE FOR ANY PURPOSE OTHER THAN THAT WHICH IS NECESSARY FOR PREPARATION OF BIDS OF ENGINEERING WITHOUT THE EXPRESS PERMISSION OF JANUS WHICH MAY RECALL DOCUMENTS AT ANY TIME.

UNLESS OTHERWISE SPECIFIED DIMENSIONS ARE IN INCHES. TOLERANCES LISTED BELOW.

DECIMAL	FRACTIONS	ANGLES	HOLE DIAMETERS	
±0.030"	+/- 1/16"	+/- 0° 30'	UNDER 0.251	+ 0.004 - 0.003
±0.005"			0.251 - 0.500	+ 0.006 - 0.003
			OVER 0.500	+ 0.008 - 0.003

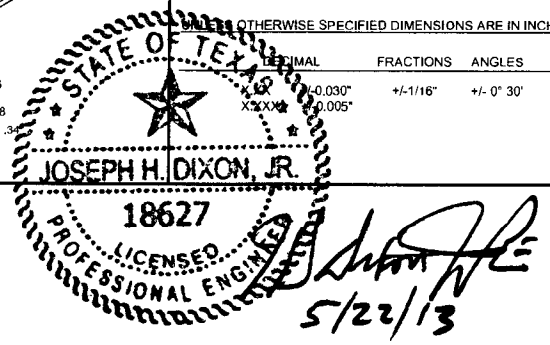

PART NUMBER:

MATERIAL:

APPLIED FINISH:

UNIT OF MEASURE:

APPROVALS:

DATE	DATE
CURT SCHROEDER	11-07-12
CURT SCHROEDER	11-07-12
CURT SCHROEDER	11-07-12

JANUS INTERNATIONAL CORPORATION
 134 JANUS INTERNATIONAL BLVD TEMPLE, GA 30179
 770-562-2850/Fax 770-562-2264
 © 2012 Janus International Corporation All Rights Reserved

CERTIFIED WIND LOAD RATED 26
 GA. SERIES 3100 DOOR ASSEMBLY
 MAX. SIZE: 20'-0" X 20'-0"

SIZE: **B** DRAWING NUMBER: **T1005** REV. **G**

SCALE: NONE SHEET: 1 OF: 2

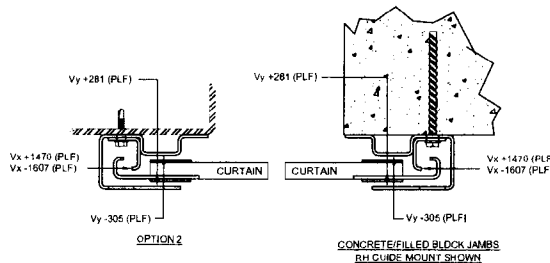
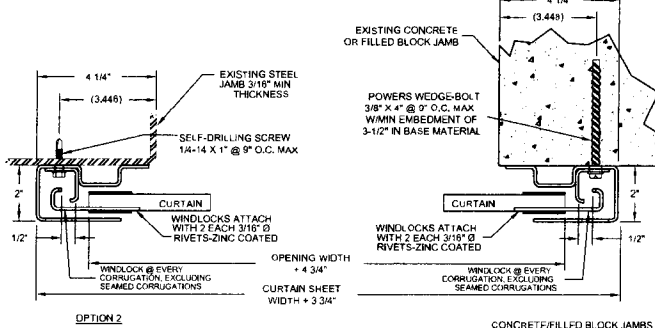
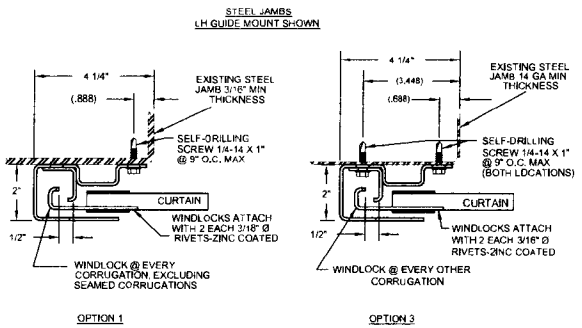

SUPERIMPOSED LOAD DIAGRAM

- GENERAL NOTES**
- THIS ROLL-UP DOOR SYSTEM IS DESIGNED IN ACCORDANCE WITH THE FLORIDA BUILDING CODE (FBC) AND INTERNATIONAL BUILDING CODE (IBC). THE REQUIRED DESIGN WIND PRESSURES FOR A DOOR IN ANY PARTICULAR BUILDING SHALL BE DETERMINED IN ACCORDANCE WITH SECTION 1609 OF THE FBC. IN CODE JURISDICTIONS OUTSIDE OF FLORIDA, REQUIRED DESIGN WIND PRESSURES MAY BE DETERMINED IN ACCORDANCE WITH SECTION 1609 OF THE IBC OR WITH THE LOCAL BUILDING CODE IN EFFECT FOR THE SPECIFIC LOCATION.
 - THIS ROLL-UP DOOR HAS BEEN SUCCESSFULLY TESTED ACCORDING TO THE UNIFORM STATIC AIR PRESSURE TEST PER ASTM E330 AND ANSI/DASMA 108 TO SAFELY RESIST A POSITIVE AND NEGATIVE WIND LOAD AS NOTED BELOW. A TEST LOAD OF 1.5 X DESIGN LOAD HAS BEEN USED.
DESIGN LOAD = $\begin{cases} +35.0 & \text{PSF} \\ -38.0 & \text{PSF} \end{cases}$
 - WIND LOADS FOR BUILDING OPENINGS SHALL BE DETERMINED BY A PROFESSIONAL ENGINEER USING APPROPRIATE WIND SPEED AND DESIGN CRITERIA. THIS DOOR MAY BE USED WHERE THE DESIGN LOAD MEETS OR EXCEEDS THE DESIGN LOAD FOR THE BUILDING OPENING.
 - SUPERIMPOSED LOADS ON THE JAMBS FROM THIS DOOR ARE DESIGNED AS Vx AND Vy HEREIN. CONTRACTORS SHALL HAVE BUILDING ENGINEER VERIFY ADEQUACY OF BUILDING STRUCTURE TO RESIST SUPERIMPOSED LOADS Vx, Vy.
 - ALL WELDING SHALL BE PERFORMED BY QUALIFIED WELDERS IN ACCORDANCE WITH A.W.S. SPECIFICATIONS, LATEST EDITION. ALL WELDING ELECTRODES SHALL CONFORM TO A.W.S. A5.1 GRADE E-70.
 - DOORS SHALL BE PROVIDED WITH LOCK MECHANISMS AT THE OPTION OF THE OWNER.
 - ALL BOLTS AND WASHERS SHALL BE GALVANIZED OR STAINLESS STEEL WITH A MINIMUM TENSILE STRENGTH OF 60 KSI.
 - DESIGN BASED ON CERTIFIED TESTING LABORATORIES, INC. TEST REPORTS NO. CTLA-1432W FOR THROUGH GUIDE ATTACHMENT TO JAMB AND NO. CTLA-1432V-1 FOR TOE OF GUIDE ATTACHMENT TO JAMB.
 - ANCHOR NOTES:
A. EMBEDMENT LENGTH DOES NOT INCLUDE STUCCO FINISH.
B. FOR HOLLOW MASONRY, FILL ALL CELLS @ ANCHOR WITH 2500 PSI GROUT.
C. ANCHORS SHALL BE INSTALLED IN ACCORDANCE WITH MANUFACTURERS SPECIFICATIONS.
 - DOOR OPERATION TYPE TO BE PUSH-UP, HAND CHAIN, OR ELECTRIC.
 - GUIDE TO JAMB ATTACHMENT FASTENERS BEGIN 4" FROM FLOOR AND 4" BELOW TOP OF THE WALL OPENING.
 - TEST DOOR WALL OPENING SIZE: 16'-0" X 8'-0".

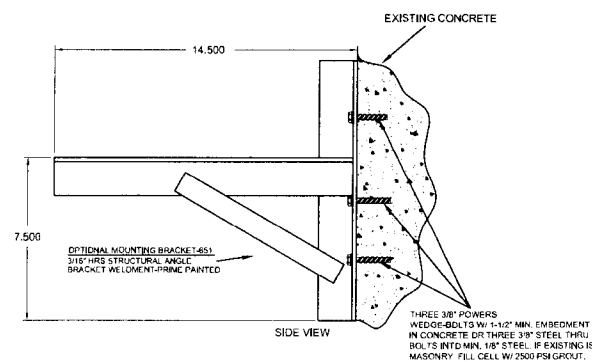
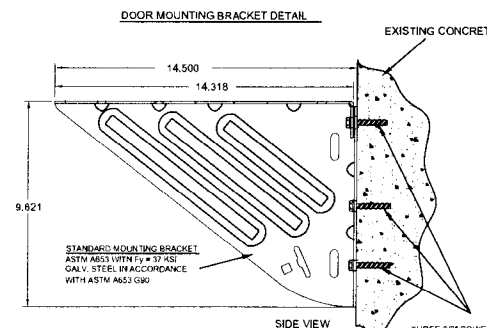

REVISIONS			
REV	DESCRIPTION	DATE	APPROVAL
—	DRAWING RELEASE	1-31-03	DM
A	DOOR ATTACH AT TOE	11-13-03	DM
B	ADD GUIDE OPTION 3	4-13-04	DM
C	RETEST FOR FLORIDA	9-26-05	DM
D	REMOVED STD NRDS. DATES	9-26-05	CS
E	ADDED 'T' BRACKET OPTION	01-20-12	CS
F	ADDED CHARTED PSF VALUES	11-07-12	CS
G	REVISED CHARTED PSF VALUES DOWN TO 10 FT. REVISED HEADROOM CHART	05-22-13	CS

ALLOWABLE TRANSVERSE DESIGN WIND LOADS			
MAX DOOR WIDTH	MAX DOOR HEIGHT	DESIGN LOAD POSITIVE (PSF)	DESIGN LOAD NEGATIVE (PSF)
10'-0"	20'-0"	77.7	83.6
11'-0"	20'-0"	65.8	70.8
12'-0"	20'-0"	56.4	61
13'-0"	20'-0"	49.3	53.3
14'-0"	20'-0"	43.5	47.2
15'-0"	20'-0"	38.8	42.1
16'-0"	20'-0"	35.0	38.0
17'-0"	20'-0"	31.8	34.5
18'-0"	20'-0"	29.0	31.5
19'-0"	20'-0"	26.6	28.9
20'-0"	20'-0"	24.5	26.7

THESE CONFIDENTIAL DOCUMENTS SUBMITTED BY JANUS CONTAIN INFORMATION OF A PROPRIETARY NATURE AND MAY NOT BE REPRODUCED OR USED TO MANUFACTURE ANYTHING IN PART OR IN WHOLE FOR ANY PURPOSE OTHER THAN THAT WHICH IS NECESSARY FOR PREPARATION OF BIDS OF ENGINEERING WITHOUT THE EXPRESS PERMISSION OF JANUS WHICH MAY RECALL DOCUMENTS AT ANY TIME.

UNLESS OTHERWISE SPECIFIED DIMENSIONS ARE IN INCHES. TOLERANCES LISTED BELOW.

FRACTIONS	ANGLES	HOLE DIAMETERS
$\pm 1/16"$	$\pm 0' 30"$	UNDER 0.251 +0.004 -0.003
		0.251 - 0.500 +0.006 -0.003
		OVER 0.500 +0.008 -0.003

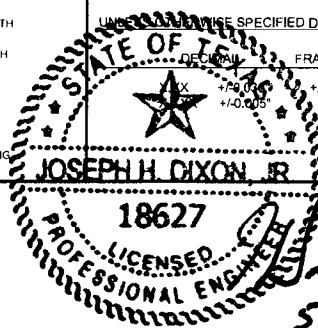

Handwritten signature and date:
5/22/13

PART NUMBER	
MATERIAL:	
APPLIED FINISH:	
UNIT OF MEASURE:	
APPROVALS	DATE
DRAWN: CURT SCHROEDER	11-07-12
CHECKED: CURT SCHROEDER	11-07-12
APPROVED: CURT SCHROEDER	11-07-12

JANUS INTERNATIONAL CORPORATION
134 JANUS INTERNATIONAL BLVD TEMPLE, GA 30179
770-562-2850/Fax 770-562-2264
© 2012 Janus International Corporation All Rights Reserved

CERTIFIED WIND LOAD RATED 26
G.A. SERIES 3100 DOOR ASSEMBLY
MAX. SIZE: 20'-0" X 20'-0"

SIZE: B	DRAWING NUMBER: T1005	REV: G
SCALE: NONE	SHEET: 2	OF: 2



Product Evaluation

GDR41 | 0318

Engineering Services Program

The following product has been evaluated for compliance with the wind loads specified in the International Residential Code (IRC) and the International Building Code (IBC).

This product evaluation is not an endorsement of this product or a recommendation that this product be used. The Texas Department of Insurance has not authorized the use of any information contained in the product evaluation for advertising, or other commercial or promotional purpose.

This product evaluation is intended for use by those individuals who are following the design wind load criteria in Chapter 3 of the IRC and Section 1609 of the IBC. The design loads determined for the building or structure shall not exceed the design load rating specified for the products shown in the limitations section of this product evaluation. This product evaluation does not relieve a Texas licensed engineer of his responsibilities as outlined in the Texas Insurance Code, the Texas Administrative Code, and the Texas Engineering Practice Act.

For more information, contact TDI Engineering Services Program at (800) 248-6032.

Evaluation ID: GDR-41

Effective Date: March 1, 2018

Re-evaluation Date: March 2022

Product Name: Series 3100 Steel Roll Up Doors, Non-Impact Resistant

Manufacturer: Janus International Corporation
135 Janus International Blvd.
Temple, GA 30179-4435
(866) 562-2580
www.janusintl.com

General Description:

This evaluation report is for the Series 3100 steel roll up doors. The steel roll-up doors consist of a corrugated steel curtain that is suspended from a barrel. Coil springs, located within the barrel, raise and lower the curtain, which wraps around the barrel. The steel curtain is raised by push-up, hand chain, or electric operation. The sides of the curtain are constrained from lateral movement along their vertical edges by steel guides that are attached to the structure. The steel rolls up doors specified in this evaluation report are non-impact resistant. This evaluation report includes the following doors:

System	Description	Maximum Width	Maximum Height
1	26 Gauge Series 3100 Roll Up Doors; Single Curtain; Windlocks	16'-0"	20'-0"
2	26 Gauge Series 3100 Roll Up Doors; Single Curtain; Windlocks	20'-0"	20'-0"

The steel roll up doors specified in this evaluation report consist of the following components:

- **Curtain:** 26-gauge corrugated steel that is roll-formed from ASTM A 653 grade 80 steel. The corrugated sheets are galvanized and pre-painted with silicone polyester paint. The corrugated sheets are interlocked mechanically to form the curtain.

- **Guides:** 12-gauge galvanized steel roll-formed from ASTM A 653 steel. The dimensions of the guide are 2" x 4" x 0.105" x full length.
- **Wind Bar:** 12-gauge galvanized steel roll-formed from ASTM A 653 steel. The dimensions of the guide are 1.188" x 0.984" x 0.188" x 0.105" x full length of guide.
- **Bottom Bar (System 1):** One 24-gauge galvanized steel bottom bar full length of curtain. One roll-formed steel angle, 2" x 1-1/2" x 0.105" x full length of curtain. The steel angle is attached to the steel bottom bar with 1/4" diameter thru bolts and lock nuts. Two bolts are located at each end and two bolts are located at the center. One bolt is located 12" on center. A continuous vinyl bulb astragal is attached to the bottom of the steel bottom bar.
- **Bottom Bar (System 2):** One 24-gauge galvanized steel bottom bar full length of curtain. Two roll-formed steel angles, 2" x 1-1/2" x 0.105" x full length of curtain. Along the vertical leg, the steel angles are attached to the steel bottom bar with 1/4" diameter thru bolts and lock nuts. Two bolts are located at each end and two bolts are located at the center. One bolt is located 12" on center. Along the horizontal leg, the steel angles are attached to each other with 1/4" diameter thru bolts and lock nuts. Two bolts are located at the center. One bolt is located 12" from the double bolts and one bolt is located 24" on center thereafter. A single bolt is located inboard of the step plate. A continuous vinyl bulb astragal is attached to the bottom of the bottom bar.
- **Windlocks (System 1):** 11-gauge galvanized steel. The dimensions of the windlock are 1.125" x 3.036". The windlock is attached to each side of the curtain at every other corrugation. Each windlock is attached to the curtain with two 3/16" diameter zinc coated rivets.
- **Windlocks (System 2):** 11-gauge galvanized steel. The dimensions of the windlock are 1.130" x 3.040". The windlock is attached to each side of the curtain at every corrugation except at the seemed corrugations. Each windlock is attached to the curtain with two 3/16" diameter zinc coated rivets.
- **Hardware:** None.

Product Identification: A label will be affixed to the bottom bar of the steel roll up door. The label must include the manufacturer's name, series number of door, the allowable design pressure rating, the design drawing number, and tested per ASTM E 330 and ANSI/DASMA 108.

Limitations:

System	Maximum Width	Maximum Height	Drawing	Design Pressure Rating (psf)
1	8'-0"	20'-0"	T1004 Rev E	+77.4, -86.4
	9'-0"			+61.3, -68.9
	10'-0"			+50.2, -56.7
	11'-0"			+42.1, -47.7
	12'-0"			+36.0, -41.0
	13'-0"			+31.3, -35.8
	14'-0"			+27.5, -31.6
	15'-0"			+24.5, -28.1
	16'-0"			+22, -25.3

Limitations (continued):

System	Maximum Width	Maximum Height	Drawing	Design Pressure Rating (psf)
2	12'-0"	20'-0"	T1005 Rev G	+56.4, -61.0
	13'-0"			+49.3; -53.3
	14'-0"			+43.5; -47.2
	15'-0"			+38.8, -42.2
	16'-0"			+35.0, -38.0
	17'-0"			+31.8; -34.5
	18'-0"			+29.0; -31.5
	19'-0"			+26.6; -28.9
	20'-0"			+24.5; -26.7

- **Glazing:** None
- **Impact Resistance:** The doors listed in this report do not satisfy TDI's criteria for protection from windborne debris. Protect the door assemblies with an impact protective system when installing the product in areas that require windborne debris protection.
- **Acceptance of Smaller Assemblies:** Door assemblies with dimensions equal to or smaller than those specified above are acceptable within the limitations specified in this report.
- **Drawings (The drawing listed below shall be available at the job site):**
 - **System 1:** Janus International Corporation; Certified Wind Load Rated 26 GA. Series 3100 Door Assembly Max. Size 16'-0" x 20'-0"; Drawing No. T1004, Rev E; Sheet 1 and 2 of 2; revised 2-28-14; sealed by Joseph H. Dixon, P.E., dated February 28, 2014.
 - **System 2:** Janus International Corporation; Certified Wind Load Rated 26 GA. Series 3100 Door Assembly Max. Size 20'-0" x 20'-0"; Drawing No. T1005, Rev G; Sheet 1 and 2 of 2; revised May 22, 2013; signed, sealed, and dated May 22, 2013, by Joseph H. Dixon, P.E.

Installation Instructions:

Install the steel roll up doors to the substrate using one of the following methods (refer to the design drawings referenced above for further guidance):

Bolted to cast-in-place, pre-cast concrete, or grout-filled CMU substrate:

- **System 1: Guide Mounting:** Anchor each guide and wind bar to the substrate with minimum 3/8" x 4" Powers Wedge-Bolt anchors. Place the anchors through the interior of the guide, through the wind bar, and into the substrate. Space the anchors a maximum of 12" on center along the length of the guide. The anchors must penetrate a minimum of 3-1/2" into the substrate. If the bolt must penetrate through a wall covering, then increase the bolt length by the thickness of the wall covering material. Locate the anchors a minimum of 3.448" from the edge of the door opening. Grout must be minimum 2,500 psi.
- **System 1: Tensioner Bracket Mounting:** Each bracket must be anchored to the substrate with three minimum 3/8" diameter Powers Wedge-Bolt anchors with a minimum 1-1/2" embedment. If the bolts must penetrate through a wall covering, then increase the bolt length by the thickness of the wall covering material.
- **System 2: Guide Mounting:** Anchor each guide and wind bar to the substrate with minimum 3/8" x 4" Powers Wedge-Bolt anchors. Place the anchors through the interior of the guide, through the wind bar, and into the substrate. Space the anchors a maximum of 9" on center along the length of the guide. The anchors must penetrate a minimum of 3-1/2" into the substrate. If the bolt must

penetrate through a wall covering, then increase the bolt length by the thickness of the wall covering material. Locate the anchors a minimum of 3.448" from the edge of the door opening. Grout must be minimum 2,500 psi.

- **System 2: Tensioner Bracket Mounting:** Anchor each bracket to the substrate with three minimum 3/8" diameter Powers Wedge-Bolt anchors with a minimum 1-1/2" embedment. If the bolts must penetrate through a wall covering, then increase the bolt length by the thickness of the wall covering material.

Bolted to steel substrate:

System 1: Guide Mounting: The steel substrate must be minimum 1/8" thick A36 steel. Mount each guide and wind bar using one of the following options:

- **Option 1:** The wind bar is welded to the guide with a 7/16" plug weld located 12" on center. Anchor the guide to the substrate with one minimum 1/4-14 x 1" self-drilling TEKS screw located at the toe of the guide. Space the screws a maximum of 12" on center along the length of the guide.
- **Option 2:** Anchor the guide and wind bar to the substrate with one minimum 1/4-14 x 1" self-drilling TEKS screw. Place the screws through the interior of the guide, through the wind bar, and into the substrate. Space the screws a maximum of 12" on center along the length of the guide.
- **Option 3:** Anchor the guide and wind bar to the substrate with one minimum 1/4-14 x 1" self-drilling TEKS screw. Place the screws through the interior of the guide, through the wind bar, and into the substrate. Anchor the toe of the guide to the substrate with one minimum 1/4-14 x 1" self-drilling TEKS screw. Space the screws a maximum of 12" on center along the length of the guide.

System 1: Tensioner Bracket Mounting: Anchor each bracket to the substrate with three minimum 3/8" steel thru bolts into minimum 1/8" steel. If the bolts must penetrate through a wall covering, then increase the bolt length by the thickness of the wall covering material.

System 2: Guide Mounting: The steel substrate must be minimum 1/8" thick A36 steel. Mount each guide and wind bar using one of the following options:

- **Option 1:** The wind bar is welded to the guide with a 7/16" plug weld located 9" on center. Anchor the guide to the substrate with one minimum 1/4-14 x 1" self-drilling TEKS screw located at the toe of the guide. Space the screws a maximum of 9" on center along the length of the guide.
- **Option 2:** Anchor the guide and wind bar to the substrate with one minimum 1/4-14 x 1" self-drilling TEKS screw. Place the screws through the interior of the guide, through the wind bar, and into the substrate. Space the screws a maximum of 9" on center along the length of the guide.
- **Option 3:** Anchor the guide and wind bar to the substrate with one minimum 1/4-14 x 1" self-drilling TEKS screw. Place the screws through the interior of the guide, through the wind bar, and into the substrate. Anchor the toe of the guide to the substrate with one minimum 1/4-14 x 1" self-drilling TEKS screw. Space the screws a maximum of 12" on center along the length of the guide.

System 2: Tensioner Bracket Mounting: Anchor each bracket to the substrate with three minimum 3/8" steel thru bolts into minimum 1/8" steel. If the bolts must penetrate through a wall covering, then increase the bolt length by the thickness of the wall covering material.

Note: Keep the manufacturer's installation instructions available on the job site during installation. Use corrosion resistant fasteners as specified in the IRC, the IBC, and the Texas Revisions.