

A low-angle, close-up photograph of a soldier inside a military vehicle. The soldier is wearing a helmet with a night vision device and is looking through the sights of a mounted machine gun. The machine gun is mounted on a heavy metal frame. The interior of the vehicle is visible, showing various mechanical components and a circular hatch. The lighting is dramatic, with a bright sun flare in the upper center of the frame. The overall tone is dark and industrial.

2018

USA

 **VICTRIX**

A R M A M E N T S





VICTRIX
A R M A M E N T S

CREATORS OF PRECISION

"When our new brand was launched, it naturally aroused much interest. Who was working on this project? Who were the technicians and engineers who make up Victrix Armaments? Who was managing the project? But most of all, who was really behind this ambitious venture? Indeed, who could take on such a major challenge?"

These are all valid questions but, is it not possible to truly understand the importance of our brand simply by asking who and how many are working on it?

I now welcome the opportunity to answer as many of these questions as I can and also to convey the real impetus behind our Company.

Behind Victrix Armaments are those most passionate about precision shooting.

Behind Victrix Armaments are individuals working at the highest level in the military arena, true experts in their particular field.

Behind Victrix Armaments are technicians and specialists in precision engineering and design who are prepared to explore all segments of their craft and expertise.

Why? After years acting as strategic partners to a large number of equipment manufacturers and particularly arms-producing companies and brands, we realised that it was now time for us to demonstrate our ability to manufacture a product without compromise and to honour our idea of precision firearms.

This is the core aim of Victrix Armaments – the will and determination to develop and manufacture new and safe generation of firearm systems for both sporting and military use without compromise.

Behind Victrix Armaments, are the men and women who have made all this possible. We are Victrix Armaments; we are creators of precision."

Giuseppe Valtorta
Founder



**PASSION ACCURACY
AND PERFECTION.**

**THESE ARE THE THREE MAIN
VALUES OF VICTRIX ARMAMENTS**

At Rottigni Officina Meccanica, a company with over 45 years of experience in high precision engineering, we have developed unique manufacturing processes, which result in extremely close tolerances unparalleled in the firearms industry.

Victrix pride and experience: Where 45 years of traditional craftsmanship dovetails with modern technology.

WHAT MAKES VICTRIX ARMAMENTS DIFFERENT

At Victrix Armaments, we see ourselves as unique within the firearms industry, with the exception of the match grade barrel, all of the other components of the rifle have been designed and manufactured inside our company.

The advantage to this, of course, is that we are not reliant on other manufacturers for supply, quality and functionality. In maintaining this degree of control, we have analysed specific materials for their mechanical qualities and incorporated them into the design and manufacture of our rifles.



INNOVATION AND DESIGN.

Every Victrix rifle is born in our in-house 3D modelling design department, where from inception to completion, each and every component is checked for its aesthetic design and functionality.

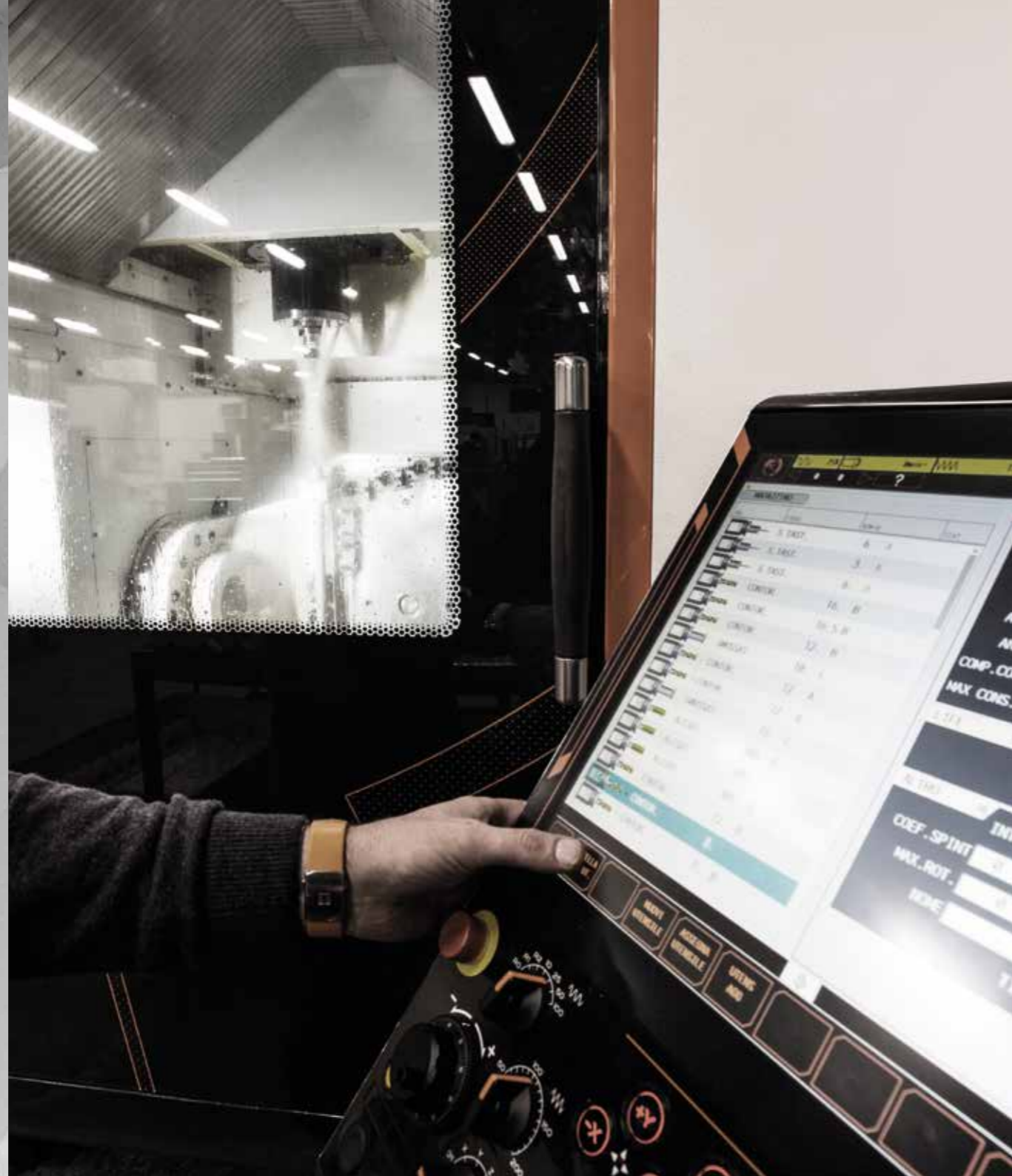

MECHANICAL WORKING.

Our team of precision engineers and craftsmen have at their fingertips the most modern and sophisticated five axis CNC machining centres, spark erosion and EDM wire cutting equipment available to them.

Our actions are worked out directly from billet on high-technological CNC machining centres, to accomplish very low geometrical and dimensional tolerances and meet extremely high-quality standards. The alloy steel used allows to achieve high mechanical specifications. Treatment processes are carefully checked as they ensure long-lasting performance standards.

All actions single shot as well as those with magazines are equipped with a three-lug bolt thus assuring the highest precision.



REVOLUTIONISED INSPECTION & ANALYSIS.

Our highly skilled and qualified technicians, using state-of-the-art measurement and test equipment guarantee the accuracy of every component.

Our laboratory is equipped with computerized tridimensional checking machining such as DEA, microscopes, roughness and roundness testers, tools for the analysis of hardness as well as manual measuring instruments. Testing and calibration measurements of all instruments and samples are performed in SIT laboratories.

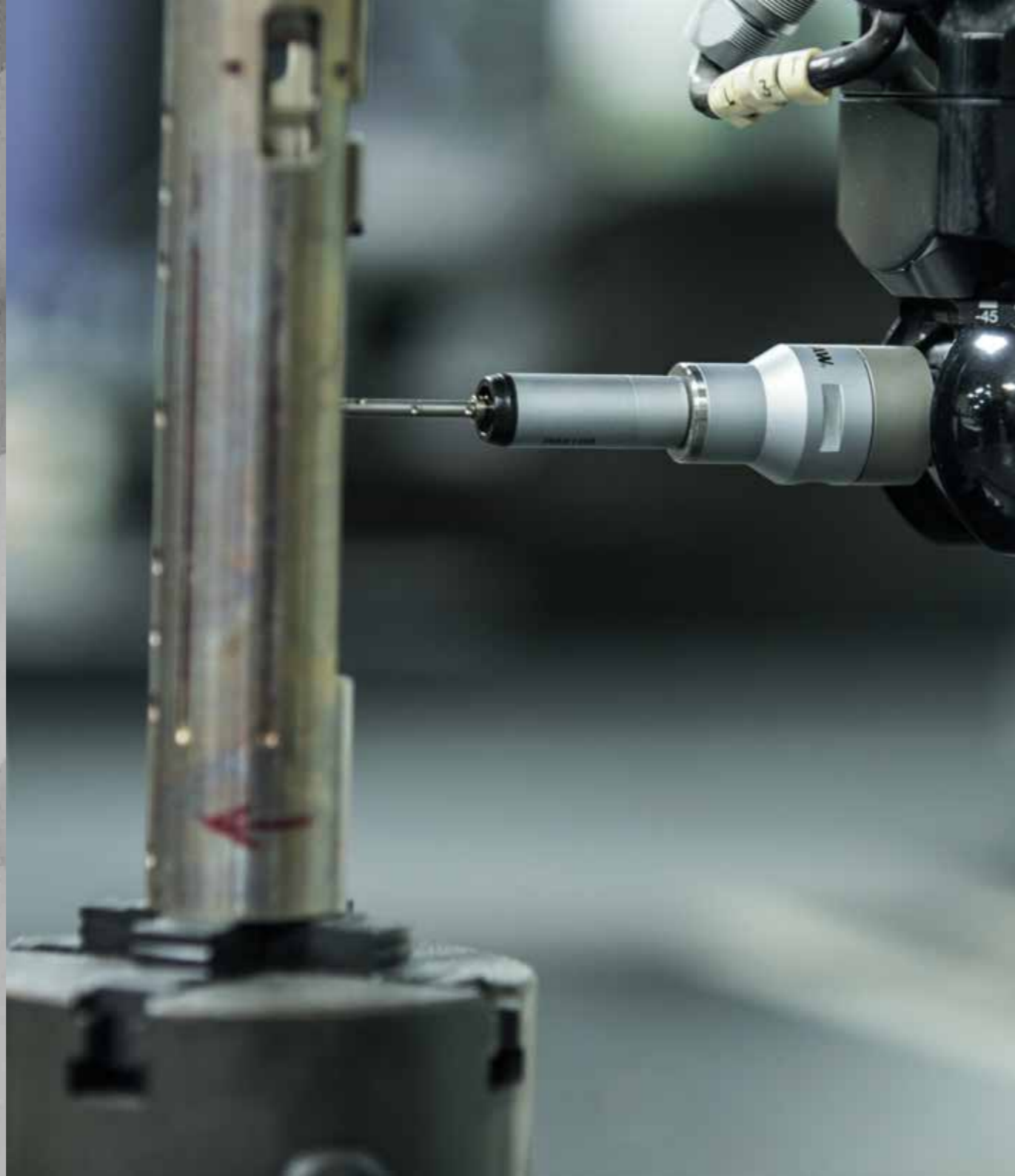

IT'S ALL IN THE DETAIL.

Attention to detail is paramount in the production of our precision rifles.

All of our components come together in our rifle building department, where each component is lovingly put together, with the emphasis on attention to detail, by our craftsmen, to produce what is known as the Victrix Precision Rifle. Victrix commands an unparalleled level of precision throughout its range.

We go straight to the heart of perfection.





MINERVA
TACTICAL

14-29



MINERVA
MILLE

30-43

44-59



VICTORIA
SPORT

60-63



LUNAE
HUNTING



Pugio

Scope, scope mount and bipod are not included in the rifle configuration.

Soft touch cheek-piece



Arrow 03 buttstock
Multi adj.



Asymmetric
3-lug bolt



- Top rail 20 MOA
- Oct. ellipt. forend



Detachable muzzle brake

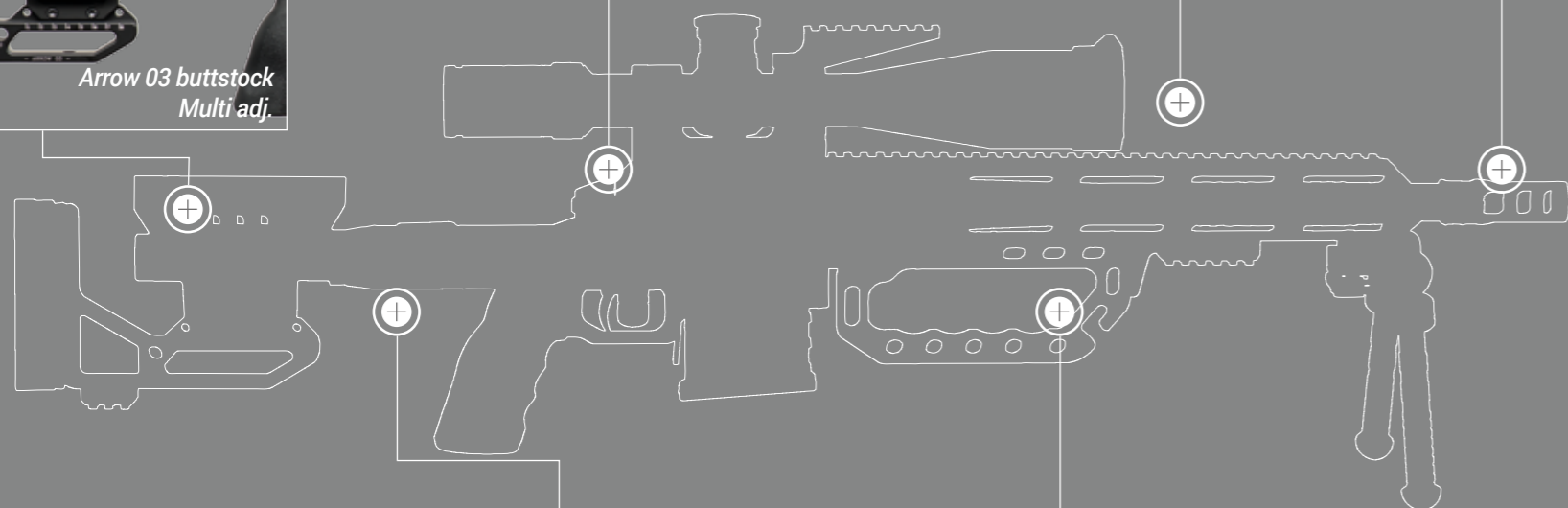

Folding Speed
w/ open-closed lock. posit. system



- Multifunction handle:**
- Tripod attach.
 - Multi QD sling attach.
 - Helisniping rod attach.
 - The tripod attach. shown in the picture is for illustration purposes only

BARREL LENGTH 16"

DIMENSION MIN./MAX. mm 720 / 1020

WEIGHT Gr. 5800

FEATURES:

Pugio

- /// Destination use: **Law Enforcement - Military**
- //// Caliber (Twist rate): **.308 Win (1/10)**
- ///// Barrel Length: **16"**

Destination Use	Law Enforcement - Military
Caliber (Twist rate)	.308 Win (1/10)
Barrel Length	16"
Barrel	Match grade in Aisi 416R lapped
Action	Minerva short 3-lug bolt action in Aisi 630 w/ detach. magaz. PVD coated
Magazine	5 Rounds, 8 Rounds option (Law enforcement - Military use)
Trigger	Selectable dual or single stage; adjustable pull weight
Safety	Upper; 2 position lever
Muzzle Brake	3 Chambers Detachable; thread M18x1
Action Rail	20 Moa
Buttstock	Arrow 03
Buttstock horiz. adj.	45 mm
Buttstock vert. adj.	60 mm
Folding	Button left side folding Speed

Forend	Octagonal Elliptic
Forend Option	Keymod
Top Rail	20 Moa
Side Rails	Standard Equipment only on Oct. Ellipt. forend
Bipod Rail	Standard Equipment w/ QD sling attach.
Monopod Rail	Stand. Equip. w/QD sling attach.
Multifunction Handle	Standard Equipment
Stock Colour	Hard Black Anodized
Option	Suppressor with quick lock system
Hard Case	Standard Equipment
Weight Gr.	5800
Dimension Min. / Max. mm	720 / 1020

All screws are in dark-treated inox steel.





VICTRIX
A R M A M E N T S

 **MINERVA**
TACTICAL



Gladius TGT

*The picture shows the model with 22" barrel.
Scope, scope mount and bipod are not included in the rifle configuration.*

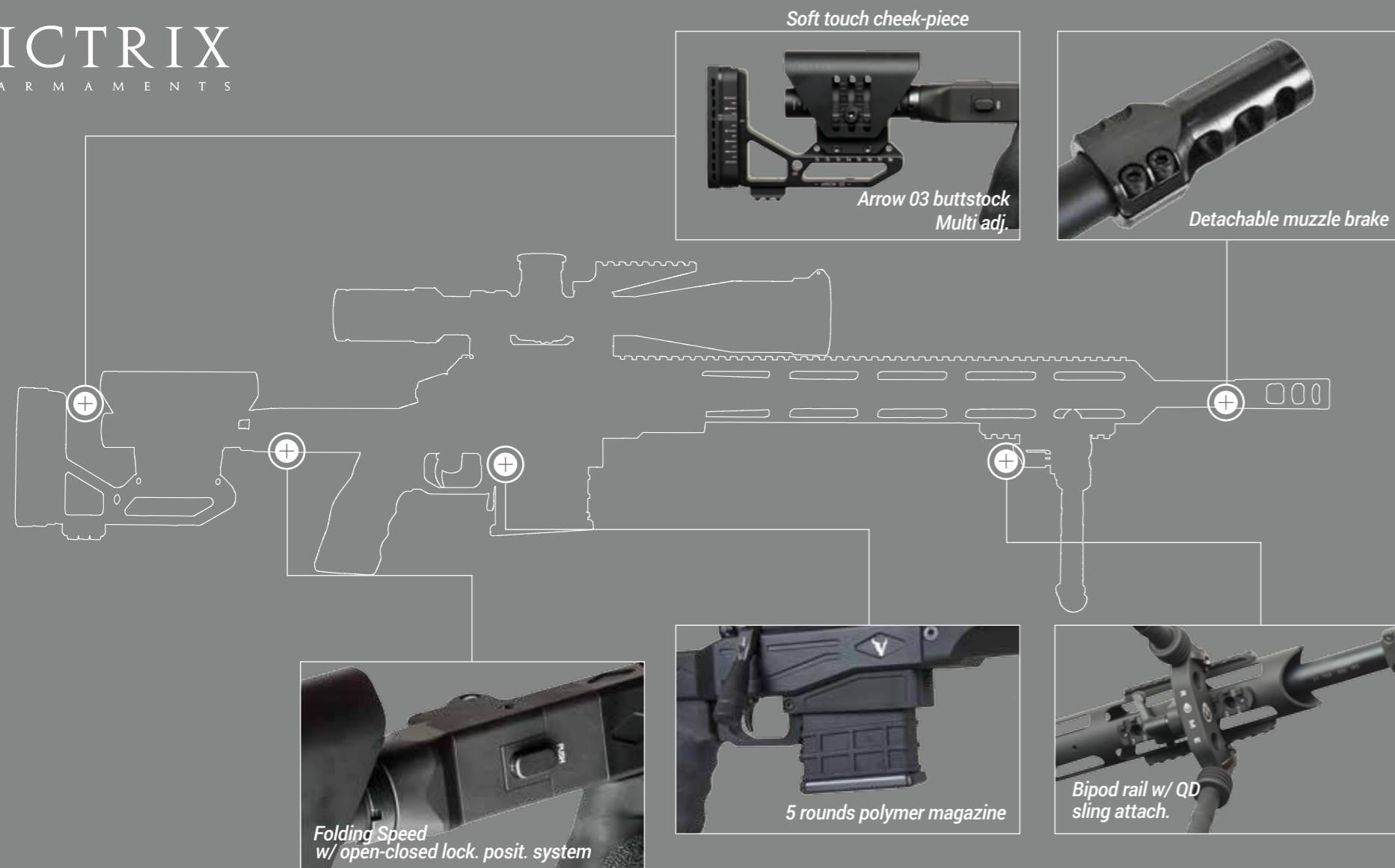

Gladius TGT

- /// Destination use: **Law Enforcement - Military**
- //// Caliber (Twist rate): **.308 Win (1/11) - .260 Rem (1/8,5) - 6,5 Creedmoor (1/8,5)**
- ///// Barrel Length: **22" - 26"**



MINERVA
TACTICAL

Destination Use	Law Enforcement - Military	Forend	Round Elliptic
Caliber (Twist rate)	.308 Win (1/11) - .260 Rem (1/8,5) - 6,5 Creedmoor (1/8,5)	Top Rail	0 Moa
Barrel Length	22"-26"	Side Rails	Optional
Barrel	Match grade in Aisi 416R lapped	Bipod Rail	Standard Equipment w/ QD sling attach.
Action	Minerva short 3-lug bolt action in Aisi 630 w/ detach. magaz. PVD coated	Monopod Rail	Stand. Equip. w/QD sling attach.
Magazine	5 Rounds, 8 Rounds option (Law enforcement - Military use)	Stock Colour	Hard Black Anodized
Trigger	Selectable dual or single stage; adjustable pull weight	Colours Option	\
Safety	Upper; 2 position lever	Option	Suppressor with quick lock system
Muzzle Brake	3 Chambers Detachable; thread M18x1	Hard Case	Standard Equipment
Action Rail	20 Moa	Weight Gr.	6050 (22") - 6400 (26")
Buttstock	Arrow 03	Dimension Min. / Max. mm	900 / 1170 (22") - 1000 / 1270 (26")
Buttstock horiz. adj.	45 mm		
Buttstock vert. adj.	60 mm		
Folding	Button left side folding Speed		

All screws are in dark-treated inox steel.

FEATURES:

BARREL LENGTH 22"-26"

DIMENSION MIN./MAX. mm
900 / 1170 (22")
1000 / 1270 (26")

WEIGHT Gr.
6050 (22")
6400 (26")



VICTRIX
A R M A M E N T S

MINERVA
T A C T I C A L



Scorpio TGT

*The picture shows the model with 26" barrel.
Scope, scope mount and bipod are not included in the rifle configuration.*

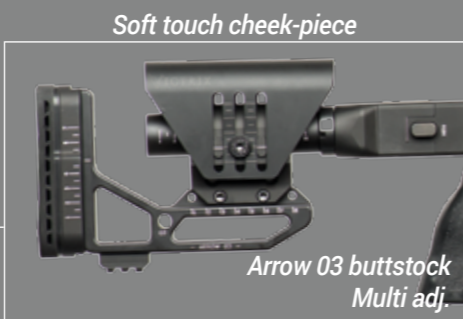
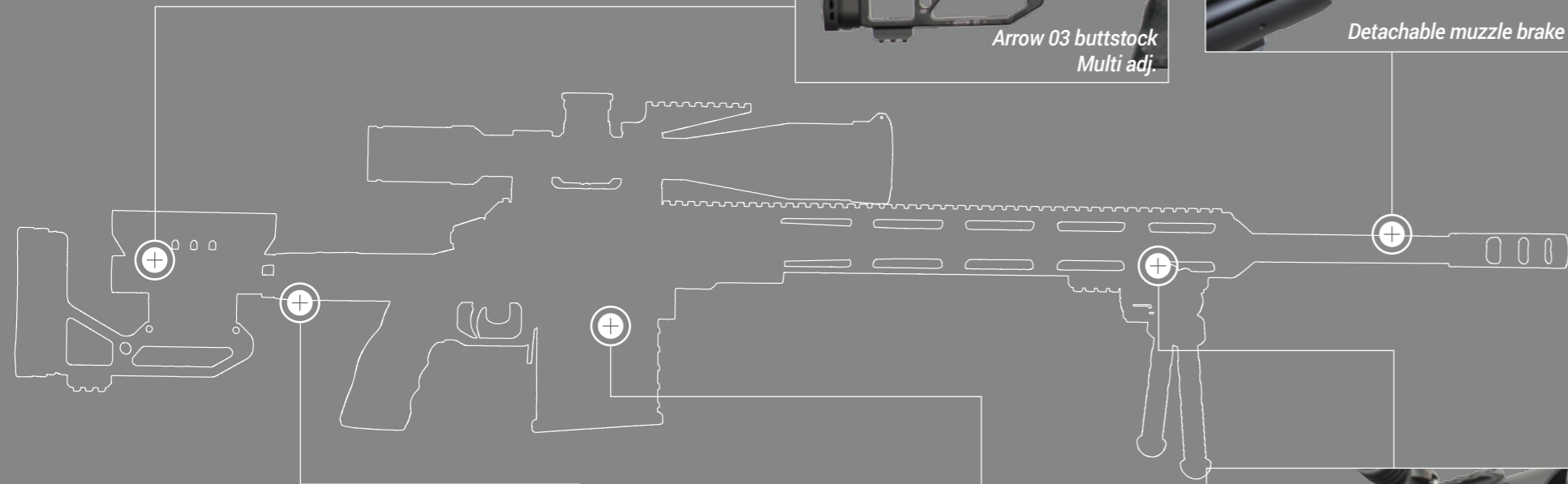

Scorpio TGT

/// Destination use: **Law Enforcement - Military**

//// Caliber (Twist rate): **.338 Lapua Magnum (1/10) - .300 Win Mag (1/10)
300 Norma Mag. (1/10)**

///// Barrel Length: **22" - 26"**



MINERVA
TACTICAL

Destination Use	Law Enforcement - Military
Caliber (Twist rate)	.338 Lapua Magnum (1/10) - .300 Win Mag (1/10) - 300 Norma Mag. (1/10)
Barrel Length	22" - 26"
Barrel	Match grade in Aisi 416R lapped
Action	Minerva long 3-lug bolt action in Aisi 630 w/ detach. magaz. PVD coated
Magazine	5 Rounds, 8 Rounds option (Law enforcement - Military use)
Trigger	Selectable dual or single stage; adjustable pull weight
Safety	Upper, 2 position lever
Muzzle Brake	3 Chambers Detachable; thread M18x1
Action Rail	20 Moa
Buttstock	Arrow 03
Buttstock horiz. adj.	45 mm
Buttstock vert. adj.	60 mm
Folding	Button left side folding Speed

Forend	Round Elliptic
Top Rail	0 Moa
Side Rails	Optional
Bipod Rail	Standard Equipment w/ QD sling attach.
Monopod Rail	Stand. Equip. w/QD sling attach.
Stock Colour	Hard Black Anodized
Colours Option	\
Option	Suppressor with quick lock system
Hard Case	Standard Equipment
Weight Gr.	6400 (22") - 6700 (26")
Dimension Min. / Max. mm	940 / 1190 (22") - 1020 / 1290 (26")

FEATURES:



All screws are in dark-treated inox steel.



VICTRIX
A R M A M E N T S

MINERVA
T A C T I C A L



Tormentum

*The picture shows the model TAN colour finished.
Scope, scope mount and bipod are not included in the rifle configuration.*

Soft touch cheek-piece

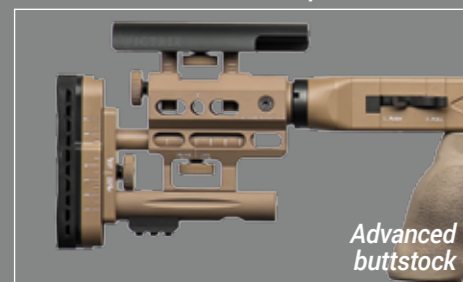

Symmetric 3-lug bolt



- Top rail 45 MOA
- Full length side rail



Detachable muzzle brake / fluted barrel

Advanced buttstock

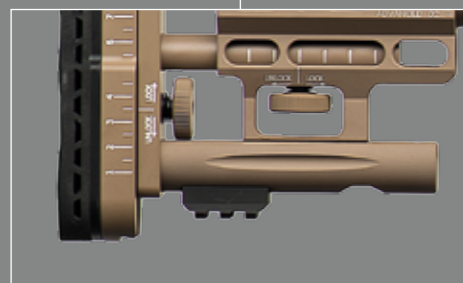
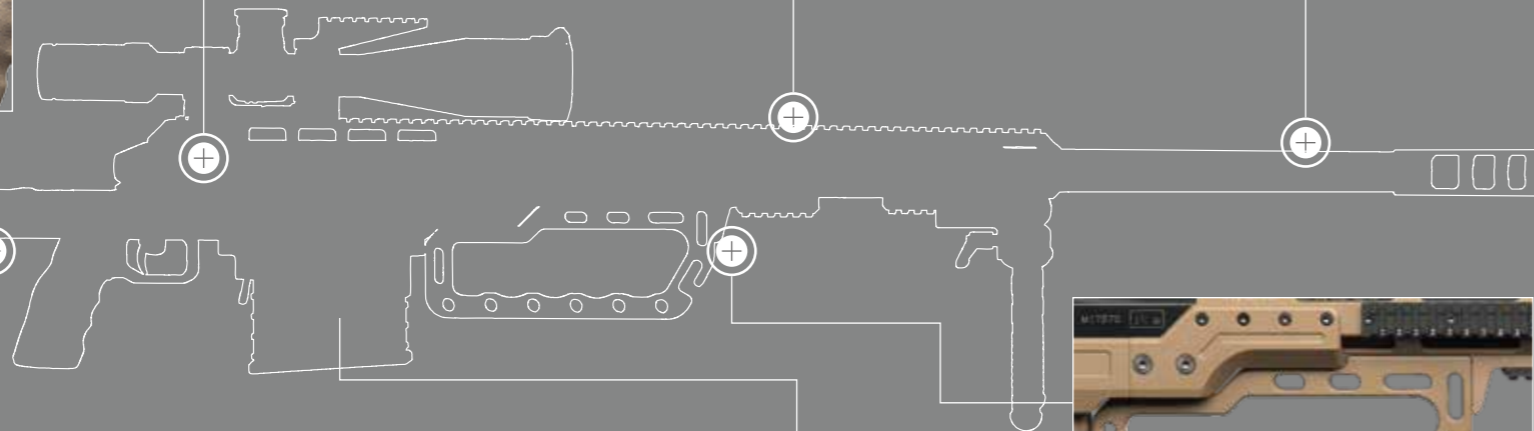

- Quick adjustment
- Monopod rail w/ QD sling attach.

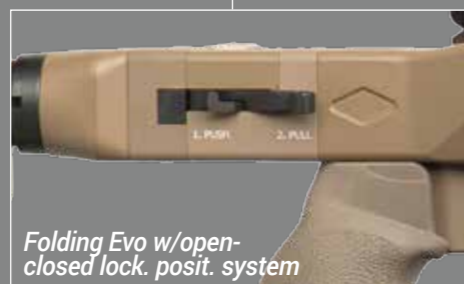

Folding Evo w/ open-closed lock posit. system



5 rounds polymer magazine

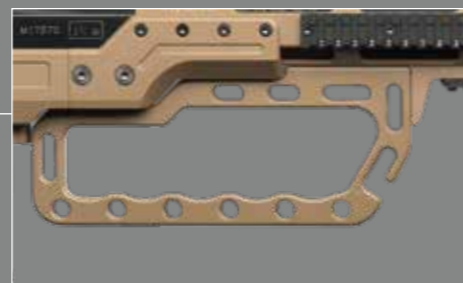

Multifunction handle:

- Tripod attach.
- Multi QD sling attach.
- Helisniping rod attach.
- Rear bipod rail

Tormentum

/// Destination use: **Law Enforcement - Military - Extreme long range shooting**

//// Caliber (Twist rate): **.375 Cheytac (1/10) - .408 Cheytac (1/13)**

///// Barrel Length: **30"**



MINERVA
TACTICAL

Destination Use	Law Enforcement - Military - Extreme long range shooting	Folding	Evo
Caliber (Twist rate)	.375 Cheytac (1/10) - .408 Cheytac (1/13)	Forend	Octagonal Elliptic
Barrel Length	30"	Top Rail	45 Moa
Barrel	Match grade in Aisi 416R lapped FLUTED	Side Rails	Standard Equipment full length
Action	Marte CT 3-lug bolt action in Aisi 630 w/ detach. magaz. PVD coated	Bipod Rail	Standard Equipment w/ QD sling attach.
Magazine	5 Rounds, 7 Rounds option (Law enforcement - Military use)	Multifunction Handle	Standard Equipment
Trigger	Selectable dual or single stage; adjustable pull weight	Stock Colour	Hard Black Anodized
Safety	Upper; 2 position lever	Colours Option	TAN (action, barrel, muzzle brake, cheek piece, magazine, screws and rails: BLACK)
Muzzle Brake	3 Chambers Detachable; thread M24x1	Hard Case	Standard Equipment
Action Rail	45 Moa	Weight Gr.	12700
Buttstock	Advanced	Dimension Min. / Max. mm	1230 / 1480
Buttstock horiz. adj.	50 mm		
Buttstock vert. adj.	60 mm		
Monopod Rail	Stand. Equip. w/ QD sling attach.		

All screws are in dark-treated inox steel.

FEATURES:

MINIMIZED RECOIL

BARREL LENGTH 30"

DIMENSION MIN./MAX. mm 1230 / 1480

.375 CT / .408 CT





VICTRIX
A R M A M E N T S

MINERVA
MILLE



Corvus

Scope and scope mount are not included in the rifle configuration.

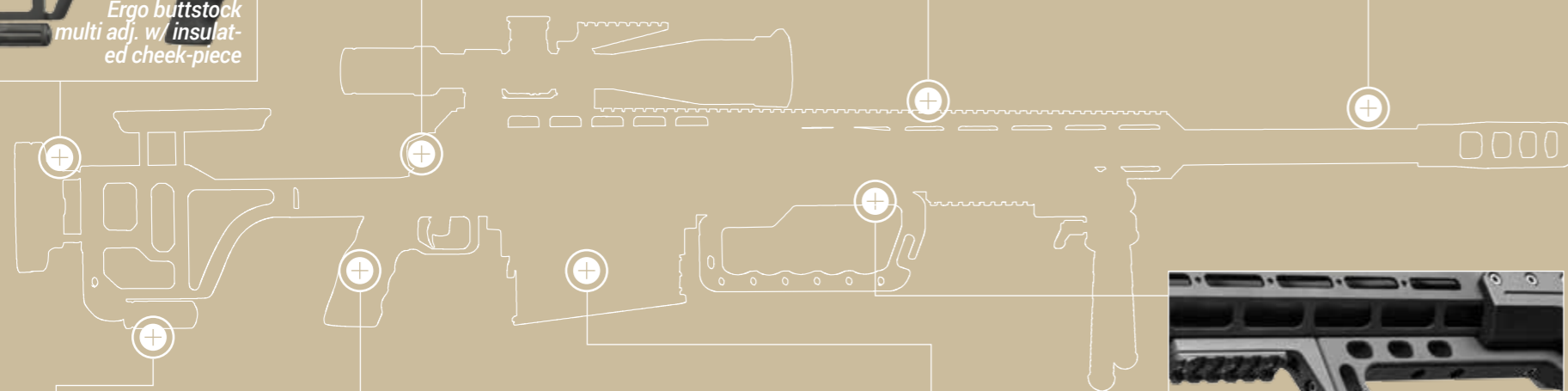
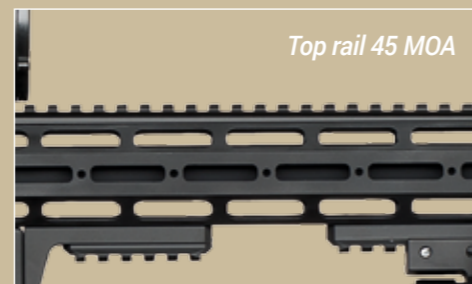
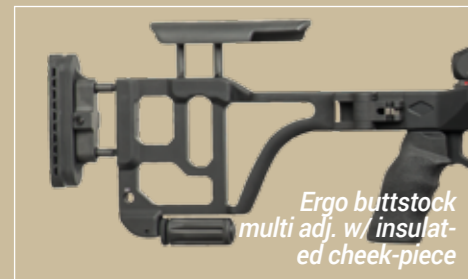

- Multi quick adjustments
- Integral monopod

FEATURES:



Corvus

- /// Destination use: **Law Enforcement - Military**
- //// Caliber (Twist rate): **.50 BMG (12,7x99)**
- ///// Barrel Length: **27"**



MINERVA
MILLE

Destination Use	Law Enforcement - Military
Caliber (Twist rate)	.50 BMG (12,7x99)
Barrel Length	27"
Barrel	Match Grade stainless steel lapped FLUTED
Action	Corvus 3-lug bolt action in Aisi 630 w/ detach. magaz, PVD coated, black matt finishing
Magazine	5 Rounds polymer
Trigger	Selectable dual or single stage; adjustable pull weight
Safety	Upper, 2 position lever
Muzzle Brake	4 Chambers Detachable; thread M24x1
Action Rail	45 Moa
Buttstock	Ergo with quick adj.
Buttstock horiz. adj.	24 mm
Buttstock vert. adj.	16 mm

Folding	Button right side folding Speed
Forend	Octagonal Elliptic with M-LOK system
Top Rail	45 Moa
Side Rails	Standard Equipment
Bipod Rail	Standard Equipment w/ QD sling attach.
Multifunction Handle	Standard Equipment
Stock Colour	Hard Black Anodized
Colours Option	TAN (action, barrel, muzzle brake, cheek piece, monopod, magazine, screws, rails: BLACK)
Option	Suppressor
Hard Case	For Hard Use; Standard Equipment
Weight Gr.	13000
Dimension Min. / Max. mm	1180 / 1450
Equipment included	Cleaning and tool kit with cordura pouch; sling; bipod; 2 magazines; hard case black with custom cut interior

All screws are in dark-treated inox steel.

Pugio MilLe

- /// Destination use: **Law Enforcement - Military**
- //// Caliber (Twist rate): **.308 Win (1/10)**
- ///// Barrel Length: **16"**



MINERVA
MILLE



- Button right side folding Speed with bolt handle locking system
- Locking system in both open-closed position

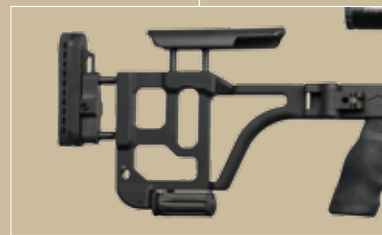
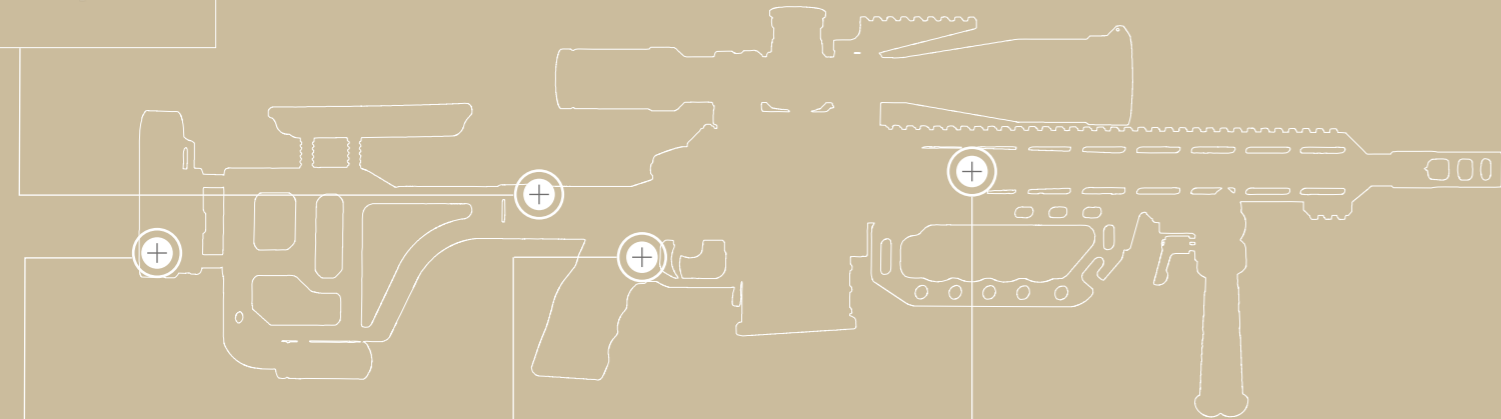

Ergo buttstock multi adj. w/ insulated cheek-piece



Action and bolt black matt finishing



Octagonal elliptic forend w/ M-LOK



The picture shows the model with a suppressor with quick detach locking system, available as an option.



FEATURES:



Destination Use	Law Enforcement - Military
Caliber (Twist rate)	.308 Win (1/10)
Barrel Length	16"
Action	Minerva short 3-lug bolt action in Aisi 630 w/ detach. magaz. PVD coated, black matt finishing
Magazine	5 Rounds, 8 Rounds option (Law enforcement - Military use)
Trigger	Selectable dual or single stage; adjustable pull weight
Safety	Upper, 2 position lever

Muzzle Brake	3 Chambers Detachable; thread M18x1
Action Rail	20 Moa
Forend	Octagonal Elliptic with M-LOK system
Top Rail	20 Moa
Option	Suppressor with quick lock system
Weight Gr.	5850
Dimension Min. / Max. mm	720 / 1030

All screws are in dark-treated inox steel.

Gladius MilLe



MINERVA
MILLE

- /// Destination use: **Law Enforcement - Military**
- //// Caliber (Twist rate): **.308 Win (1/11) - .260 Rem (1/8,5) - 6,5 Creedmoor (1/8,5)**
- ///// Barrel Length: **22" - 26"**



- Button right side folding Speed with bolt handle locking system
- Locking system in both open-closed position

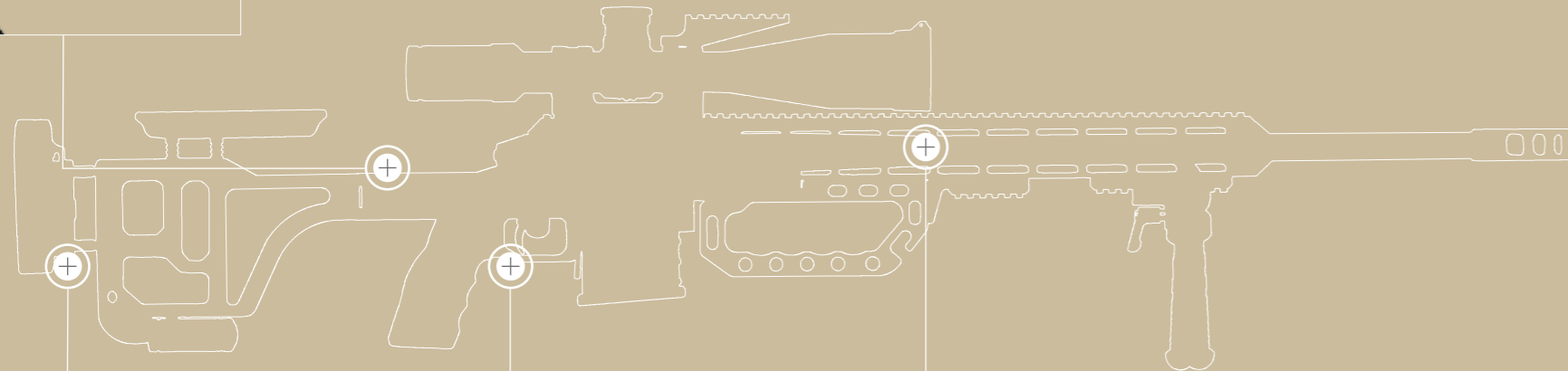

Ergo buttstock multi adj. w/ insulated cheek-piece



Action and bolt black matt finishing



Octagonal elliptic forend w/ M-LOK



The picture shows the model with a suppressor with quick detach locking system, available as an option.

FEATURES:

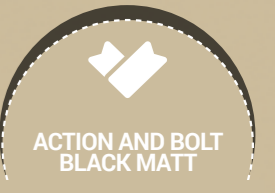
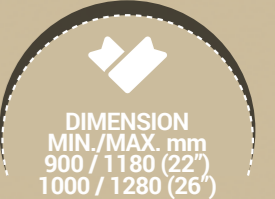

Destination Use	Law Enforcement - Military
Caliber (Twist rate)	.308 Win (1/11) - .260 Rem (1/8,5) - 6,5 Creedmoor (1/8,5)
Barrel Length	22" - 26"
Action	Minerva short 3-lug bolt action in Aisi 630 w/ detach. magaz. PVD coated, black matt finishing
Magazine	5 Rounds, 8 Rounds option (Law enforcement - Military use)
Trigger	Selectable dual or single stage; adjustable pull weight
Safety	Upper, 2 position lever

Muzzle Brake	3 Chambers Detachable; thread M18x1
Action Rail	20 Moa
Forend	Octagonal Elliptic with M-LOK system
Top Rail	20 Moa
Option	Suppressor with quick lock system
Weight Gr.	6400 (22") - 6700 (26")
Dimension Min. / Max. mm	900 / 1180 (22") - 1000 / 1280 (26")

All screws are in dark-treated inox steel.

Scorpio MilLe

/// Destination use: **Law Enforcement - Military**
 //// Caliber (Twist rate): **.338 Lapua Magnum (1/10) - .300 Win Mag (1/10) - 300 Norma Mag. (1/10)**
 ///// Barrel Length: **22" - 26"**



MINERVA
MILLE



- Button right side folding Speed with bolt handle locking system
- Locking system in both open-closed position

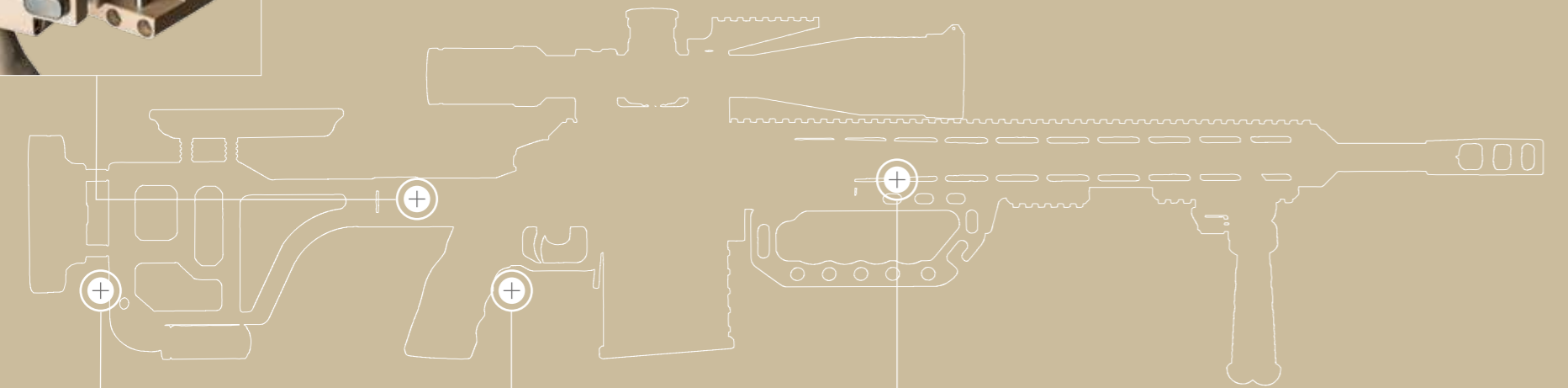

Ergo buttstock multi adj. w/ insulated cheek-piece



Action and bolt black matt finishing

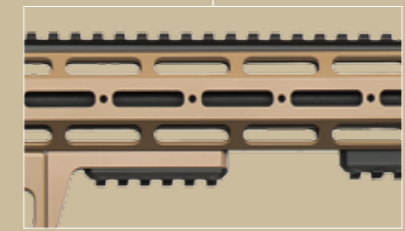

Octagonal elliptic forend w/ M-LOK



The picture shows the model with a suppressor with quick detach locking system, available as an option.



FEATURES:

- BARREL LENGTH 22-26"**
- DIMENSION MIN./MAX. mm 940 / 1220 (22") 1020 / 1320 (26")**
- WEIGHT Gr. 6700 (22") 7050 (26")**
- TAN COLOUR AVAILABLE**
- ACTION AND BOLT BLACK MATT**

Destination Use	Law Enforcement - Military
Caliber (Twist rate)	.338 Lapua Magnum (1/10) - .300 Win Mag (1/10) - 300 Norma Mag. (1/10)
Barrel Length	22" - 26"
Action	Minerva long 3-lug bolt action in Aisi 630 w/ detach. magaz. PVD coated, black matt finishing
Magazine	5 Rounds, 8 Rounds option (Law enforcement - Military use)
Trigger	Selectable dual or single stage; adjustable pull weight
Safety	Upper, 2 position lever

Muzzle Brake	3 Chambers Detachable; thread M18x1
Action Rail	20 Moa
Forend	Octagonal Elliptic with M-LOK system
Top Rail	20 Moa
Option	Suppressor with quick lock system
Weight Gr.	6700 (22") - 7050 (26")
Dimension Min. / Max. mm	940 / 1220 (22") - 1020 / 1320 (26")

All screws are in dark-treated inox steel.

Tormentum MilLe

- /// Destination use: **Law Enforcement - Military**
- //// Caliber (Twist rate): **.375 Cheytac (1/10) - .408 Cheytac (1/13)**
- ///// Barrel Length: **30"**



MINERVA
MILLE



FEATURES:



BARREL LENGTH 30"



MINIMIZED RECOIL



.375 CT / .408 CT



TAN COLOUR AVAILABLE



ACTION AND BOLT BLACK MATT



Ergo buttstock multi adj. w/ insulated cheek-piece



- Button right side folding Speed with bolt handle locking system
- Locking system in both open-closed position



Action and bolt black matt finishing



Octagonal elliptic forend w/ M-LOK

Destination Use	Law Enforcement - Military
Caliber (Twist rate)	.375 Cheytac (1/10) - .408 Cheytac (1/13)
Barrel Length	30"
Action	Marte CT 3-lug bolt action in Aisi 630 w/ detach. magaz. PVD coated, black matt finishing
Magazine	5 Rounds, 7 Rounds option (Law enforcement - Military use)
Trigger	Selectable dual or single stage; adjustable pull weight
Safety	Upper, 2 position lever

Muzzle Brake	3 Chambers Detachable; thread M24x1
Action Rail	45 Moa
Forend	Octagonal Elliptic with M-LOK system
Top Rail	45 Moa
Weight Gr.	12700
Dimension Min. / Max. mm	1230 / 1520

All screws are in dark-treated inox steel.



VICTRIX
ARMAMENTS

VICTORIA
SPORT



Target Series

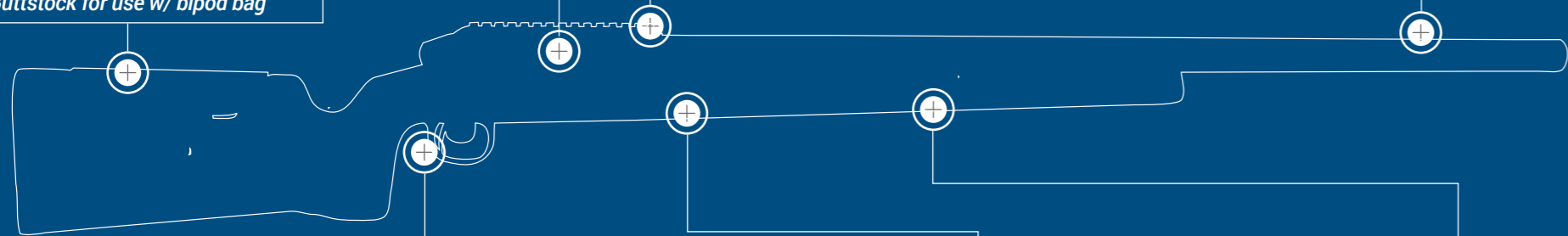
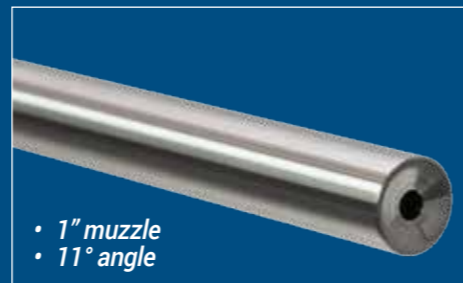

FEATURES:

**ACTION LEFT
VERSION AVAILABLE**

**DESIGNED
FOR
BIPOD / BAG**

**WEIGHT Gr.
6620 (28")
6750 (30")
6890 (32")**

**BARREL
LENGTH
28" - 30" - 32"**

**MONOBLOCK
BEDDING SYSTEM**

Target Series

/// Destination use: **Sporting by bipod / bag**

//// Caliber: **.300 WSM - .308 Win Match - .308 Win - .284 Win - 7/270 WSM - 6,5 Creedmoor - 6,5x47 Lapua - 6 XC - 6 BR -**

Destination Use	Sporting by bipod/bag
Caliber (Twist rate)	.300 WSM (1/10 - 32") - .308 Win Match (1/11 - 30") - .308 Win Match (1/10 - 32") - .308 Win (1/11 - 30") - .284 Win (1/8,5 - 32") - 7/270 WSM (1/8,5 - 32") - 6,5 Creedmoor (1/8,5 - 30") - 6,5x47 Lapua (1/8,5 - 30") - 6 XC (1/8,5 - 28") - 6 BR (1/8,5 - 28")
Barrel Length	See caliber
Barrel	Match grade in Aisi 416R lapped - 1" muzzle
Action	Victoria 3-lug bolt action single shot in Aisi 630 PVD coated (std: right port - right bolt)
Action option	Left version: left port-right bolt
Trigger	4-lever Single Stage
Action Rail	20 Moa
Buttpad horizontal adj.	Optional
Buttpad vertical adj.	Optional
Bipod Rail	Standard Anschütz



Monoblock system	Standard Equipment
Hard Case	Standard Equipment
Weight Gr.	6620 (28") - 6750 (30") - 6890 (32")
Dimension mm	1300
Stock Colour	Blue Laminate - Grey Laminate - Red Laminate
Colours Option	All stocks of the Victoria series are swappable.





VICTRIX
A R M A M E N T S

VICTORIA
S P O R T



Absolute Series

The picture shows the model with a buttpad horizontal adjustment, available as an option.

Buttpad horizontal adj. option



- Adjustable cheek-piece
- Buttpad for use w/ rest bag



Asymmetric 3-lug bolt



Action rail 20 MOA

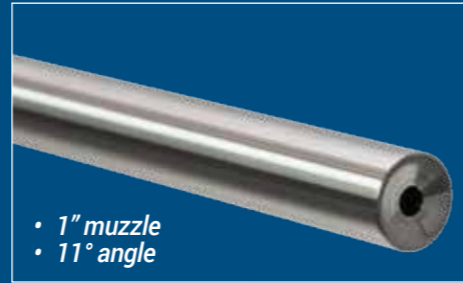

- 1" muzzle
- 11° angle

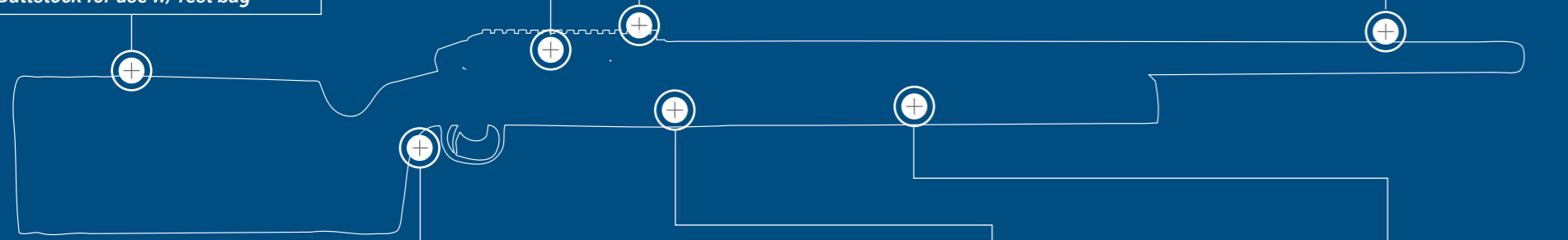

4-lever trigger



Integrated stabilizer plate



Monoblock system

Absolute Series

- /// Destination use: **Sporting by rest**
- //// Caliber: **.300 WSM - .308 Win Match - .308 Win - .284 Win - 7/270 WSM - 6,5 Creedmoor - 6,5x47 Lapua - 6 XC - 6 BR -**

Destination Use	Sporting by rest
Caliber (Twist rate)	.300 WSM (1/10 - 32") - .308 Win Match (1/11 - 30") - .308 Win Match (1/10 - 32") - .308 Win (1/11 - 30") - .284 Win (1/8,5 - 32") - 7/270 WSM (1/8,5 - 32") - 6,5 Creedmoor (1/8,5 - 30") - 6,5x47 Lapua (1/8,5 - 30") - 6 XC (1/8,5 - 28") - 6 BR (1/8,5 - 28")
Barrel Length	See caliber
Barrel	Match grade in Aisi 416R lapped - 1" muzzle
Action	Victoria 3-lug bolt action single shot in Aisi 630 PVD coated (std: right port - right bolt)
Action option	Left version: left port-right bolt
Trigger	4-lever Single Stage
Action Rail	20 Moa
Buttpad horizontal adj.	Optional
Buttpad vertical adj.	Standard equipment
Bipod Rail	Use by Rest

Monoblock system	Standard Equipment
Hard Case	Standard Equipment
Weight Gr.	8640 (28") - 8780 (30") - 8920 (32")
Dimension mm	1330
Stock Colour	Blue Laminate - Grey Laminate - Red Laminate
Colours Option	All stocks of the Victoria series are swappable.



FEATURES:

ACTION LEFT VERSION AVAILABLE

DESIGNED FOR REST / BAG

WEIGHT Gr. 8640 (28") 8780 (30") 8920 (32")

BARREL LENGTH 28" - 30" - 32"

MONOBLOCK BEDDING SYSTEM



VICTRIX
A R M A M E N T S

VICTORIA
SPORT



Sport Series

*The picture shows the target model for bipod use.
"Target" buttstock and forend.*

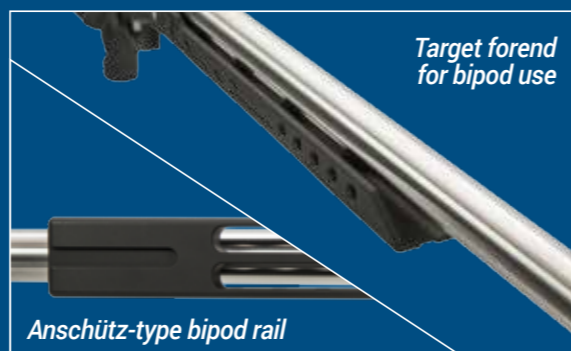

Anschütz-type bipod rail

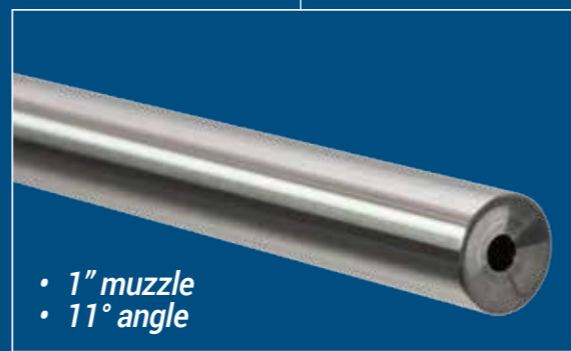
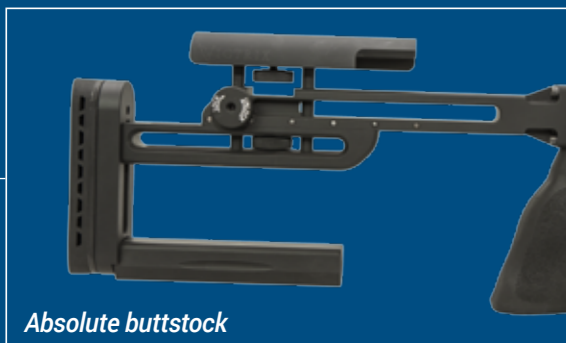
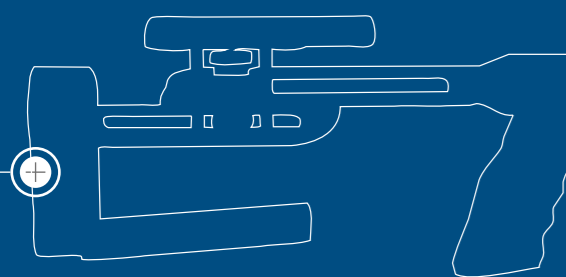

Sport Series

/// Destination use: **Sporting bipod/bag - rest**
 /// Caliber: **.300 WSM - .308 Win Match - .308 Win - .284 Win - 7/270 WSM - 6,5 Creedmoor - 6,5x47 Lapua - 6 XC - 6 BR -**

Destination Use	Sporting by bipod/bag - rest
Caliber (Twist rate)	.300 WSM (1/10 - 32") - .308 Win Match (1/11 - 30") - .308 Win Match (1/10 - 32") - .308 Win (1/11 - 30") - .284 Win (1/8,5 - 32") - 7/270 WSM (1/8,5 - 32") - 6,5 Creedmoor (1/8,5 - 30") - 6,5x47 Lapua (1/8,5 - 30") - 6 XC (1/8,5 - 28") - 6 BR (1/8,5 - 28")
Barrel Length	See caliber
Barrel	Match grade in Aisi 416R lapped - 1" muzzle
Action	Victoria 3-lug bolt action single shot in Aisi 630 PVD coated (std: right port - right bolt)
Action option	Left version: left port-right bolt
Trigger	4-lever Single Stage
Action Rail	20 Moa
Buttstock	Target
Horizontal Adjustment	Standard Equipment
Vertical Adjustment	Standard Equipment

Buttstock Option	Absolute for rest / bag use
Forend	Target for bipod use
Forend Option	Absolute for rest / bag use
Bipod Rail	Standard Anschütz (only for target forend)
Stock Colour	Hard Black Anodized
Colours Option	All stocks of the Victoria series are swappable.
Hard Case	Standard Equipment
Weight Gr.	6610 (28") - 6750 (30") - 6890 (32")
Dimension mm	1300



FEATURES:

ACTION LEFT VERSION AVAILABLE

WEIGHT Gr.
6610 (28")
6750 (30")
6890 (32")

BARREL LENGTH
28" - 30" - 32"

FMRC CHASSIS



VICTRIX
A R M A M E N T S

VICTORIA
S P O R T



Carbon performance



Carbon performance

/// Destination use: **Sporting bipod/bag - rest**
 /// Caliber: **.300 WSM - .308 Win Match - .308 Win - .284 Win - 7/270 WSM - 6,5 Creedmoor - 6,5x47 Lapua - 6 XC - 6 BR -**



VICTORIA
SPORT

Destination Use	Sporting by bipod/bag
Caliber (Twist rate)	.300 WSM (1/10 - 32") - .308 Win Match (1/11 - 30") - .308 Win Match (1/10 - 32") - .308 Win (1/11 - 30") - .284 Win (1/8,5 - 32") - 7/270 WSM (1/8,5 - 32") - 6,5 Creedmoor (1/8,5 - 30") - 6,5x47 Lapua (1/8,5 - 30") - 6 XC (1/8,5 - 28") - 6 BR (1/8,5 - 28")
Barrel Length	See caliber
Barrel	Match grade in Aisi 416R lapped - 1" muzzle
Action	Victoria 3-lug bolt action single shot in Aisi 630 PVD coated (std: right port - right bolt)
Action option	Left version: left port-right bolt
Trigger	4-lever Single Stage
Action Rail	20 Moa
Buttpad horizontal adj.	Optional
Buttpad vertical adj.	Optional
Bipod Rail	Standard Anschütz

Monoblock system	Standard Equipment
Stock Colour	Visible Carbon Fiber matt
Colours Option	All stocks of the Victoria series are swappable.
Hard Case	Standard Equipment
Weight Gr.	6030 (28") - 6180 (30") - 6350 (32")
Dimension mm	1300



FEATURES:

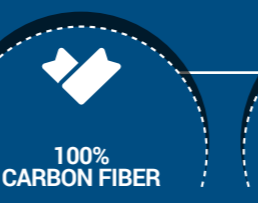



VICTRIX
A R M A M E N T S

LUNAE
HUNTING



Lunae

The picture shows the model with a black finished barrel, available as an option.

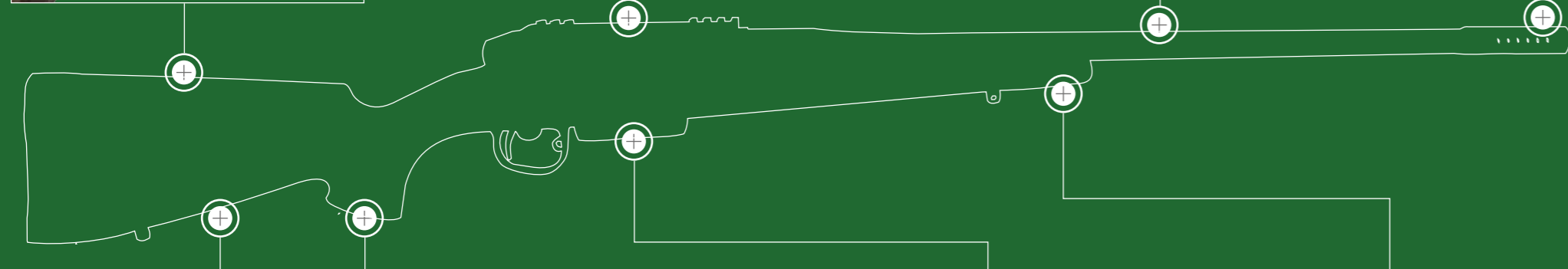

FEATURES:

 WEIGHT Gr. 3400 (22") 3600 (24") 3800 (26")	 BARREL LENGTH 22" - 24" - 26"	 3-LUG BOLT	 MONOBLOCK BEDDING SYSTEM
---	---	-----------------------	-------------------------------------

Lunae

/// Destination use: **Hunting**
 /// Caliber: **.300 WM - 7 Rem Mag - .270 WSM - .308 Win - 6 XC -**



LUNAE
HUNTING

Destination Use	Hunting
Caliber (Twist rate)	.300 WM (1/10 - 24" - 26") - 7 Rem Mag (1/8,5 - 24" - 26") - .270 WSM (1/9 - 24" - 26") - .308 Win (1/11 - 22") - 6 XC (1/8,5 - 22")
Barrel Length	See caliber
Barrel	Match grade in Aisi 416R lapped FLUTED
Action	Lunae 3-lug bolt action in Aisi 630 w/ detachable magazine PVD coated
Magazine	Metal 3 Rounds
Trigger	Selectable dual or single stage; adjustable pull weight
Safety	Upper; 2 position lever
Muzzle Brake	Radial Detachable; thread M16x1
Action Rail	20 Moa
Bipod Rail	Sling Attach.
Monoblock system	Standard equipment
Stock Colour	Solid Walnut premium grade oil finished

Hard Case	Standard Equipment
Weight Gr.	3400 (22") - 3600 (24") - 3800 (26")
Dimension Min. / Max. mm	1100 (22") - 1200 (24") - 1255 (26")
Option	Barrel and muzzle brake Cerakote black finishing







VICTRIX

A R M A M E N T S

victrix@beretta.com

Catalogue 2018/0

The contents indicated in this catalogue may be subject to modifications without notice.



VICTRIX

ARMAMENTS



Foto: by Cocchio, Papagni © azlab.it



 BERETTA

IBDT

Rev. 2018/0

www.victrixarmaments.com
www.beretta.com
www.berettadefensetechnologies.com