

**Envizio Pro™ and Envizio Pro II®
Installation and Operation Manual**

P/N 016-0171-493 Rev. I 4/16/15 E24690

Disclaimer

While every effort has been made to ensure the accuracy of this document, Raven Industries assumes no responsibility for omissions and errors. Nor is any liability assumed for damages resulting from the use of information contained herein.

Raven Industries shall not be responsible or liable for incidental or consequential damages or a loss of anticipated benefits or profits, work stoppage or loss, or impairment of data arising out of the use, or inability to use, this system or any of its components. Raven Industries shall not be held responsible for any modifications or repairs made outside our facilities, nor damages resulting from inadequate maintenance of this system.

As with all wireless and satellite signals, several factors may affect the availability and accuracy of wireless and satellite navigation and correction services (e.g. GPS, GNSS, SBAS, etc.). Therefore, Raven Industries cannot guarantee the accuracy, integrity, continuity, or availability of these services and cannot guarantee the ability to use Raven systems, or products used as components of systems, which rely upon the reception of these signals or availability of these services. Raven Industries accepts no responsibility for the use of any of these signals or services for other than the stated purpose.

Appendices

| | |
|--|-----------|
| Calibration Reference Sheet | vii |
| Unit Definitions and Conversions | viii |
| Unit of Measure Definitions | viii |
| Unit of Measure Conversions | viii |
| Chapter 1 <i>Important Safety Information</i>..... | 1 |
| Safety Information | 1 |
| Hydraulic Safety | 2 |
| Electrical Safety | 2 |
| Chapter 2 <i>Introduction</i>..... | 3 |
| Envizio Pro Features | 4 |
| Speed Compensated Product Control and Datalogging | 4 |
| On-Screen Guidance | 5 |
| Internal DGPS Receiver Options | 5 |
| Optional Features | 7 |
| Front Panel | 8 |
| Resistive Touch Screen Technology | 8 |
| Icon Based Operation | 8 |
| USB File Transfer | 9 |
| Rear Panel | 10 |
| Care and Use | 11 |
| Technical Specifications | 12 |
| Updates | 14 |
| Chapter 3 <i>Installation</i>..... | 15 |
| Overview of the Installation Process | 15 |
| Kit Contents | 16 |
| Mounting the Field Computer | 17 |
| Cable Platforms and Connections | 18 |
| Generation 1 Cable Connections | 18 |
| Generation 2 Cable Connections | 20 |
| DGPS Antenna | 21 |
| Installing Optional Equipment | 23 |
| Boom Sense Wire | 23 |
| AccuBoom™ | 24 |
| Light Bar | 25 |
| TM-1 Tilt Module | 25 |
| SmarTrax™ | 26 |
| Serial Console | 26 |

Table of Contents

| | |
|---|-----------|
| AutoBoom® | 27 |
| CANbus Network Connection | 27 |
| Chapter 4 CAN Networking and Diagnostics | 29 |
| CAN Diagnostics | 30 |
| Node Version Information | 31 |
| Readdressing Product Nodes | 31 |
| Reset CANbus Defaults | 32 |
| Retry CAN Communication | 32 |
| Service Mode | 32 |
| Additional Node Options | 33 |
| CAN Troubleshooting | 34 |
| CAN Node Off-line Errors | 34 |
| Chapter 5 Startup, Initial Setup, and Setup Wizards..... | 37 |
| Overview | 37 |
| Initial Setup | 37 |
| Startup | 38 |
| Touch Screen Calibration | 39 |
| Initial Setup Wizard | 40 |
| Setup Wizards | 42 |
| Setup Wizard Menu | 42 |
| Product Section Setup Wizard | 43 |
| Using the Product Section Setup Wizard | 43 |
| Product Control Setup Wizard | 44 |
| Using the Product Control Setup Wizard | 45 |
| AutoBoom® Setup Wizard | 49 |
| Using the AutoBoom® Setup Wizard | 49 |
| Chapter 6 Basic Operation..... | 51 |
| Overview | 51 |
| Home Screen | 51 |
| GPS Status | 52 |
| Wireless Communications Status | 53 |
| Information | 53 |
| Closing Jobs and Power Down | 54 |
| Job Files | 55 |
| Overview | 55 |
| Starting a Job | 56 |
| Setting up a Job | 56 |
| Guidance Screen | 62 |
| Guidance Features | 62 |

| | |
|---|-----------|
| Using Guidance Patterns | 63 |
| Product Control Features | 66 |
| Menu | 72 |
| Home | 72 |
| Guidance Views | 72 |
| A-B Path Tools | 73 |
| Field Markers | 77 |
| Field Review Mode | 78 |
| Field Review Mode Tools | 78 |
| Field Boundaries | 80 |
| Field Boundary Tools | 81 |
| Drift Shift | 83 |
| Prescription Maps and Variable Rates | 85 |
| Loading Prescription Maps | 85 |
| Applying Prescription Maps | 86 |
| Using Prescription Maps | 87 |
| System Alarms | 87 |
| Alarms Area | 88 |
| Audible Alarms | 88 |
| Chapter 7 Tools Menu | 89 |
| Accessing and Navigating the Tools Menu | 89 |
| Wizard Menu | 90 |
| System Menu | 90 |
| GPS Menu | 90 |
| Computer Menu | 90 |
| Vehicle Menu | 91 |
| Show All | 91 |
| Navigation | 91 |
| On-Screen Keyboard | 92 |
| System Menu | 93 |
| Control Interface | 94 |
| Product Control Options | 94 |
| Boom Master and System Options | 97 |
| Serial Port Configuration | 98 |
| CAN Diagnostics | 98 |
| Product Control | 99 |
| Application Type | 100 |
| Speed | 101 |
| Valve | 103 |
| Calibration Settings | 109 |
| AccuBoom | 113 |
| Volume and Area Settings | 113 |
| Feature Settings | 114 |

Table of Contents

| | |
|--|-----|
| Zero Speed | 114 |
| Decimal Shift | 115 |
| Display Smoothing | 115 |
| Ratio Rate | 115 |
| Agitator | 115 |
| PWM Smart Control | 115 |
| Dual Loop Control | 116 |
| Standby Pressure (PWM Valves Only) | 116 |
| Alarm Settings | 116 |
| Bin Alarm | 117 |
| Vacuum Alarm | 117 |
| CAN Audible Alarm | 117 |
| Flow Error Cal (CAN Motor Control) | 117 |
| NH3 Configuration | 117 |
| Dual Flow (%) Percent | 118 |
| Low Pressure | 118 |
| Low Tank or Bin | 118 |
| Low Limit | 118 |
| Low Supply Alarm | 118 |
| Max Pressure Alarm | 119 |
| Off Rate Percent | 119 |
| Current Alarms | 119 |
| Section Assignments | 119 |
| AutoBoom® | 120 |
| Steering | 120 |
| GPS Menu | 120 |
| Reverse Sensing | 121 |
| GPS Health | 122 |
| Differential | 125 |
| Default Differential | 131 |
| Output | 131 |
| Source | 133 |
| Tilt Sensor | 134 |
| Drift Shift | 134 |
| Computer Menu | 135 |
| Display | 135 |
| Region | 137 |
| Updates | 138 |
| File Maintenance | 140 |
| Web | 140 |
| Vehicle Menu | 141 |
| Low Speed Mode | 141 |
| Guidance Width | 141 |
| Offsets and Implement Type Selection | 142 |

| | |
|--|------------|
| Sections | 147 |
| Profiles | 152 |
| Show All | 152 |
| Chapter 8 <i>Software Updates and File Maintenance</i> | 153 |
| Overview | 153 |
| File Maintenance | 154 |
| File Outputs | 154 |
| Performing File Maintenance | 155 |
| File Structure | 158 |
| ePro Directory | 158 |
| Updates | 160 |
| Applying Software Updates | 162 |
| Chapter 9 <i>Using AccuBoom™</i> | 163 |
| Introduction | 163 |
| CAN Switch Box | 163 |
| AccuBoom™ Setup | 164 |
| On Override | 164 |
| Aggressiveness | 165 |
| Master Pressure | 166 |
| Turn Off Percent | 166 |
| Look Ahead | 167 |
| Enable Zero Speed Override Popup | 167 |
| Enabling AccuBoom™ | 167 |
| AccuBoom™ Modes | 169 |
| On-Screen Switch Box | 171 |
| Using Zone Maps | 172 |
| Loading a Field Boundary | 172 |
| AccuBoom™ Mapping Tools | 173 |
| On-Screen Tools | 173 |
| Creating an AccuBoom™ Zone Map | 174 |
| AccuBoom™ Zone Map Examples | 176 |
| Chapter 10 <i>Using AutoBoom®</i> | 179 |
| Introduction | 179 |
| PowerGlide Plus | 179 |
| UltraGlide | 180 |
| AutoBoom® Operation | 180 |
| Status Display | 180 |
| AutoBoom® Indicators | 181 |

Chapter 11 Troubleshooting 183

- Troubleshooting Information 183
 - General Issues 183
 - Setup Issues 184
 - Job Issues 184
 - Coverage Map Issues 185
- Error Messages 185
 - Job Error Messages 185
 - GPS Error Messages 186
- CAN Troubleshooting 186

Appendix A Calculating the Calibration Values..... 187

- Speed Cal 187
 - Wheel Drive Speed Sensor 188
 - Speedometer Drive Speed Sensor 189
- Liquid Applications 190
 - Boom Cal 190
 - Meter Cal 191
 - Valve Cal 194
 - Valve Cal 2 195
 - Flow Cal (Dual Loop Control Mode) 195
 - Sgain (Pressure System Gain - Dual Loop Control Mode) 195
 - Rate Cal 196
- Tiered Boom Settings 197
- Granular Applications 199
 - Boom Cal 199
 - Spreader Constant 199
 - Verification of Spreader Constant 200
 - Product Density 200
 - Rate Cal 200
 - Spinner RPM 201
- Additional Calibration Data 202
 - Entering Tank Volume or Bin Level 202
 - Reset Volume/Area Display Information 202
 - Reset Display Distance 202

Appendix B Testing Cables 203

- Speed Sensor Extension Cable 203
 - Testing the Speed Sensor Extension Cable 203
- Flow Meter/Encoder Extension Cable 204
 - Testing the Flow Meter/Encoder Cable 204

| | | |
|-------------------------------------|--|------------|
| Appendix C | <i>Wireless Communications & Remote Service</i> | 205 |
| Wireless Communication Status | | 205 |
| Wireless Status Screen | | 206 |
| Site Information | | 206 |
| Remote Service | | 207 |
| Connection Status | | 207 |
| File Manager | | 208 |
| Registration | | 208 |
| File Transfer Settings | | 210 |
| Appendix D | <i>Weather Station</i> | 211 |
| Weather Station Overview | | 211 |
| Connecting the Weather Station | | 212 |
| Weather Station Activation Key | | 212 |
| Weather Station Configuration | | 212 |
| Using the Weather Station | | 213 |
| Appendix E | <i>Updating CAN Nodes via the Envizio Pro</i> | 215 |
| Appendix F | <i>Updating the On-board DGPS Receiver</i> | 217 |
| Required Components | | 217 |
| Receiver Information | | 218 |
| Updating the On-Board DGPS Receiver | | 218 |
| Appendix G | <i>Tank Fill Monitor Calibration</i> | 221 |
| Overview | | 221 |
| Tank Fill Calibration | | 221 |
| Tank Fill Operation | | 222 |
| Appendix H | <i>Blockage Monitoring Sensors</i> | 223 |
| System Overview | | 223 |
| Blockage Node Detection | | 223 |
| Configuring Blockage Sensor Loops | | 224 |
| Configure Sensor Loops | | 225 |
| Blockage Monitor Status | | 226 |
| Setting the Sensitivity | | 227 |
| Appendix I | <i>OmniSeed™ Calibration</i> | 229 |
| OmniSeed Calibration Overview | | 229 |

Table of Contents

| | |
|---|------------|
| Remote Tank Console | 229 |
| Optional Ultrasonic Bin Level Sensors | 229 |
| OmniSeed Calibration Procedures | 230 |
| Optional Bin Pressure Sensor Calibration | 231 |
| Fan Calibration | 231 |
| Metered Weight | 232 |
| Section Setup | 233 |
| Section Assignments | 234 |
| Section Switch Mapping | 235 |
| Bin Level Sensor Calibration | 236 |
| Capacitive Bin Level Sensors | 236 |
| Optional Ultrasonic Bin Level Sensors | 237 |
| Remote Calibration Console | 238 |
| Kit Contents | 238 |
| Console Connection | 238 |
| Console Power | 239 |
| Remote Tank Console Operation | 239 |
| Using the Tank Console To Adjust Settings | 242 |
| Troubleshooting | 244 |
| | |
| Appendix J Serial Console Interfaces..... | 245 |
| Console Connection | 245 |
| Serial Control Setup and Configuration | 246 |
| Section and Guidance Width Configuration | 246 |
| AccuBoom™ Configuration | 248 |
| Operation | 249 |
| Hopper Contents | 249 |
| Area Covered & Coverage Mapping Information | 250 |
| Automatic Variable Rate | 250 |
| | |
| Appendix K Reference of Icons | 251 |
| Navigation | 251 |
| Home Screen | 252 |
| Information | 252 |
| GPS Status | 253 |
| Wireless Communications Status | 254 |
| Tools Menu | 254 |
| File Maintenance | 255 |
| CAN Diagnostics | 256 |
| Guidance Patterns | 257 |
| Guidance Screen | 257 |
| Guidance Views | 258 |
| On-Screen Switch Box | 258 |

| | |
|----------------------------------|-----|
| Field Review Mode Tools | 259 |
| A-B Path Tools | 260 |
| Field Boundary Tools | 263 |
| Alarms | 264 |
| AccuBoom™ | 264 |
| On-Screen Tools | 265 |
| AutoBoom® | 266 |
| AutoBoom® Status Indicator | 266 |

Calibration Reference Sheet

Record the settings and calibration values used when programming the field computer and keep this sheet for future reference or when contacting a service technician.

Circle the setting selected on the field computer for the following options:

| | | | | |
|---------------------|-------------------|---------------|-------------------------|--|
| Units | US (Acres) | SI (Hectares) | Turf (1000 Square Feet) | |
| Speed Sensor | SP1 (Wheel Speed) | SP2 (Radar) | Speed Cal | |

Write down the selected settings for each configured control channel in the spaces provided.

| | | | | |
|---------------------|--------------------------|--------------------------|--------------------------|--------------------------|
| | Control Channel 1 | Control Channel 2 | Control Channel 3 | Control Channel 4 |
| Control Type | | | | |
| Valve Type | | | | |

Write down the calculated calibration values in the spaces provided.

| Section Widths (Boom Cal) | | | |
|---------------------------|----|-----|-----|
| 1. | 5. | 9. | 13. |
| 2. | 6. | 10. | 14. |
| 3. | 7. | 11. | 15. |
| 4. | 8. | 12. | 16. |

| Meter Cal | Rate Cal | Valve Cal | Volume in Tank/Bin |
|-----------|----------|-----------|--------------------|
| 1. | 1. | 1. | 1. |
| 2. | 2. | 2. | 2. |
| 3. | 3. | 3. | 3. |
| 4. | 4. | 4. | 4. |

Unit Definitions and Conversions

Unit of Measure Definitions

| Abbreviation | Definition | Abbreviation | Definition |
|--------------|-------------------------------|--------------|------------------------------|
| GPM | Gallons per Minute | dm | Decimeters |
| lit/min | Liters per Minute | m | Meter |
| dl/min | Deciliters per Minute | MPH | Miles per Hour |
| PSI | Pounds per Square Inch | km | Kilometers |
| kPa | Kilopascal | km/h | Kilometers per Hour |
| GPA | Gallons per Acre | US | Volume per Acre |
| lit/ha | Liters per Hectare | SI | Volume per Hectare |
| ml/ha | Milliliters per Hectare | TU | Volume per 1,000 Square Feet |
| GPK | Gallons per 1,000 Square Feet | [] | Metric Numbers |
| mm | Millimeters | lb/acre | Pounds per Acre |
| cm | Centimeters | kg/ha | Kilograms per Hectare |

Unit of Measure Conversions

To convert the meter cal value into the selected unit of measure, divide the original number printed on the Flow Meter label by the desired conversion value.

| Fluid Ounces Conversion Formula | Liters Conversion Formula | Pounds Conversion Formula |
|---|---|--|
| $\frac{\text{Original Meter Cal}}{128}$ | $\frac{\text{Original Meter Cal}}{3.785}$ | $\frac{\text{Original Meter Cal}}{\text{Weight of One Gallon of Product}}$ |

Liquid

- 1 U.S. gallon = 128 fluid ounces
- 1 U.S. gallon = 3.785 liters
- 1 U.S. gallon = 0.83267 imperial gallons
- 1 U.S. gallon = 8.34 pounds (water)

Area

- 1 square meter = 10.764 square feet
- 1 hectare = 2.471 acres or 10,000 square meters
- 1 acre = 0.405 hectares or 43,560 square feet
- 1 square mile = 640 acres or 258.9 hectares

Length

- 1 millimeter (mm) = 0.039 inches
- 1 centimeter (cm) = 0.393 inches
- 1 meter (m) = 3.281 feet
- 1 kilometer (km) = 0.621 miles
- 1 inch = 25.4 mm or 2.54 cm
- 1 mile = 1.609 km

Pressure

- 1 psi = 6.89 kPa
- 1 kPa = 0.145 psi

Weight

- 1 Pound = 16 Ounces
- 1 Pound = 0.45 Kilograms

CHAPTER

1

Important Safety Information

Safety Information

NOTICE

Read this manual and the operation and safety instructions included with the implement and/or controller carefully before installing the Envizio Pro field computer.

- Follow all safety information presented within this manual.
- If you require assistance with any portion of the installation or service of Raven equipment, contact a local Raven dealer for support.
- Follow all safety labels affixed to the system components. Be sure to keep safety labels in good condition and replace any missing or damaged labels. To obtain replacements for missing or damaged safety labels, contact a local Raven dealer.

When operating the machine after installing the Envizio Pro field computer, observe the following safety measures:

- Be alert and aware of surroundings.
- Do not operate the field computer while under the influence of alcohol or an illegal substance.
- Remain in the operator's position in the machine at all times when the field computer is engaged.
- Determine and remain a safe working distance from other individuals. Disable the field computer when the safe working distance has been diminished.
- Disable the field computer prior to starting any maintenance work on the machine or parts of the field computer.
- Follow all label instructions for proper chemical mixing, handling and container disposal methods.

DANGER

Thoroughly bleed the nurse tank hose and all other system lines prior to disassembling the flow meter, fittings, and hoses, especially in the case of anhydrous ammonia.

 **CAUTION**

Hydraulic Safety

- Raven Industries recommends that appropriate protective equipment be worn at all times when working on any hydraulic system.
- Never attempt to open or work on a hydraulic system with the equipment running. Care should always be taken when opening a system that has been previously pressurized.
- Exercise caution when disconnecting the hydraulic hoses or purging is required, be aware that the hydraulic fluid may be extremely hot and under high pressure.
- Any work performed on a hydraulic system must be done in accordance with the machine manufacturer's approved maintenance instructions.
- When installing hydraulics or performing diagnostics, maintenance or routine service, ensure that precautions are taken to prevent any foreign material or contaminants from being introduced into the machine's hydraulic system. Objects or materials that are able to bypass the machine's hydraulic filtration system will reduce performance and possibly damage the hydraulic valves.

Electrical Safety

- Always verify that the power leads are connected to the correct polarity as marked. Reversing the power leads could cause severe damage to the equipment.
- Ensure that the power cable is the last cable to be connected.
- Always remove the power connections for the field computer and any control nodes from the vehicle battery before jump starting or welding on any component of the vehicle. Jump starting or welding on the equipment will damage the field computer and nodes.

CHAPTER

2

Introduction

Envizio Pro field computers are multi-purpose tools offering the latest technology in precision agriculture with features including product application control, field map and application reports, as well as field guidance. The Envizio Pro and Envizio Pro II field computers are available with an optional internal DGPS (Differential Global Positioning System) receiver to simplify console installation and allow the system to be transferred to other vehicles over the growing season.

This manual provides information for the following Envizio Pro series field computers:

- Envizio Pro™
- Envizio Pro II®

FIGURE 1. Versatile Envizio Pro or Envizio Pro II Field Computers



Note: *Envizio Pro series field computers are also capable of interfacing with various Raven control systems and optional features. Refer to the Optional Features section on page 7 or contact a local Raven dealer for a full list of features and systems available for use with the field computer or purchasing assistance.*

This document is intended to provide information regarding the following aspects of the Envizio Pro field computers:

- Installation
- Initial Setup and Calibration
- Basic Operation
- Updates and Feature Activation
- Advanced Features and Operation

Envizio Pro Features

The following descriptions offer a brief introduction to the capabilities of the Envizio Pro field computers and some of the optional features available for use with each of these systems.

Speed Compensated Product Control and Datalogging

Envizio Pro field computers are capable of monitoring or controlling product application via either a serial or CANbus rate control system.

Raven CANbus Control

The Envizio Pro field computers are capable of controlling up to four products or control channels through product control nodes connected to a CANbus system. The field computer automatically adjusts the application rate of each product according to the speed of the vehicle, width and status of programmed sections and a programmed target rate.

With the optional variable rate application (VRA) feature, the Envizio Pro field computers are also capable of controlling a single product according to a prescription map.

Note: *An optional multiple product control key is required to enable control channels three and four on the Envizio Pro and Envizio Pro II field computers.*

A multi-product VRA key is available to unlock variable rate control features for multiple product control channels. A single product VRA key is required to successfully authorize the multiple product VRA key.

Serial Rate Control

The Envizio Pro system may be used to monitor and map applications controlled by another Raven serial console, such as the Raven SCS 440 or 460 consoles, via a serial connection. Variable rate capabilities of the field computer may also be utilized with a Raven serial console to automatically adjust application rates based upon a prescription map loaded on the Envizio Pro series field computer.

A real-time, as-applied map is displayed on-screen while application information is logged and saved by the field computer. This job information may then be transferred to a USB flash drive, copied to a home or office PC and used to create printed reports and coverage maps.

Note: *The Envizio Pro is compatible with the Raven SwitchPro™ switch box and may be used to replace an existing serial rate controller with a Raven CANbus control system using the existing control hardware and cabling.*

On-Screen Guidance

The Envizio Pro field computers provide on-screen guidance in the form of a Course Direction Indicator (CDI) and on-screen light bar. The on-screen navigation features Last Pass, Pivot, Fixed Contour and Straight Line guidance patterns. In addition, the field computer can output GPS information and simulated radar speed to an external Raven light bar. See Chapter 5, *Startup, Initial Setup, and Setup Wizards*, for more information regarding guidance patterns and the Guidance screen.

Internal DGPS Receiver Options

Both the Envizio Pro and Envizio Pro II offer options for an internal Differential GPS (DGPS) receiver to reduce cab clutter and simplify transfer of the control system between vehicles for use during various operations such as planting, spraying and harvesting. A range of receiver options is available to fit into almost any existing system or to expand DGPS capabilities as field operations grow and change.

Note: *Field computers without the internal DGPS receiver require an external DGPS receiver for operation.*

The internal receiver in either the Envizio Pro or Envizio Pro II may be disabled to allow an optional external receiver, such as a Raven Invicta or Phoenix series or virtually any new or existing DGPS receiver, to be connected to the system. Refer to Chapter 7, Tools Menu for details on configuring the field computer to operate with external DGPS receivers and light bars.

Contact a local Raven dealer for more information about additional options or features available with the Envizio Pro or Envizio Pro II internal receiver.

Envizio Pro II Field Computers

The Envizio Pro II field computer features a dual frequency DGPS receiver which includes Satellite Based Augmentation System (SBAS) correction for use with the Wide Area Augmentation System (WAAS) or European Geostationary Navigation Overlay Service (EGNOS) as standard options. The NovAtel GL1DE[®] feature may be used either in conjunction with a SBAS correction signal as a position smoothing feature or as an independent correction source for areas with limited SBAS coverage. Both options are available as a standard feature of the internal dual frequency receiver.

The following optional correction sources may also be used with the Envizio Pro II field computer:

GLONASS. With an optional activation code, the dual frequency receiver may be unlocked to utilize the Global Navigation Satellite System (GLONASS) satellite constellation which may be used to enhance the standard GPS satellite coverage.

OmniSTAR. The Envizio Pro II field computer (P/N 063-0173-537) is available with an OmniSTAR capable receiver for use with an optional OmniSTAR HP or XP subscription. OmniSTAR subscription services provide an alternative differential source which broadcasts corrections from a worldwide array of reference sites.

Note: *Contact OmniSTAR for details and subscription information.*

Slingshot[®] GS and Satellite GS. GS subscription services offer a decimetric correction source delivered via either a satellite based correction network or over a wireless network via a Slingshot Field Hub. Contact a local Raven or Slingshot dealer for subscription details and additional information.

RTK. The Envizio Pro II internal receiver may be upgraded to receive Real-Time Kinematic (RTK) or a Continuously Operating Reference Station (CORS) network correction services to improve accuracy and repeatability for precision operations such as planting and strip tilling, or side dressing.

Envizio Pro Field Computers

Envizio Pro field computers feature an internal DGPS receiver which includes Satellite Based Augmentation System (SBAS) correction for use with the Wide Area Augmentation System (WAAS) and European Geostationary Navigation Overlay Service (EGNOS) as standard options.

The following optional correction sources may also be used with the Envizio Pro field computer:

e-Dif. An Extended Differential (e-Dif) activation key is available to provide an autonomous correction source in areas without minimal differential correction systems.

Optional Features

Flexibility of the Envizio Pro means that each field computer can be integrated into many existing Raven product control systems. The field computer can be used to control chemical injection and anhydrous ammonia applications, planting and harvesting operations or be integrated into an existing serial control system for mapping and guidance features. The following are examples of various Raven systems or features which may be added to the field computer to enhance or modify the control system for a specific operation:

- Raven product control systems.
- AccuBoom™ or AccuRow™ automatic section control systems.
- OmniRow® automatic planter population, singulation, and section control system for complete crop input control.
- OmniSeed™ automatic seeder control system for products applied from an air cart.
- AutoBoom® automatic boom height management systems.
- SmarTrax™ series automatic assisted steering systems.
- TM-1 Tilt Module offers tilt corrected DGPS guidance over rough and hilly terrain.
- Slingshot® Field Hub for communication and GPS corrections delivered via a cellular service provider.
- SmartYield™ Pro yield monitoring systems.
- Sidekick™ or Sidekick Pro™ direct injection systems for automatic rate control of injected chemicals.
- AccuFlow™ and AccuFlow HP™ series systems for anhydrous ammonia (NH₃) product application.
- Spectrum® Technologies WatchDog Sprayer Station for weather monitoring.
- Amazone Amatron+, Bogballe Calibrator Zurf, and Rauch LH5000 spreader control systems.

Contact a local Raven dealer for more information about these and other optional features and components available for use with the Envizio Pro.

Front Panel

The front panel of the Envizio Pro features a touch screen for operator input, the power button and also provides convenient access to a USB port for file transfer and software updates.

FIGURE 2. Envizio Pro User Interface

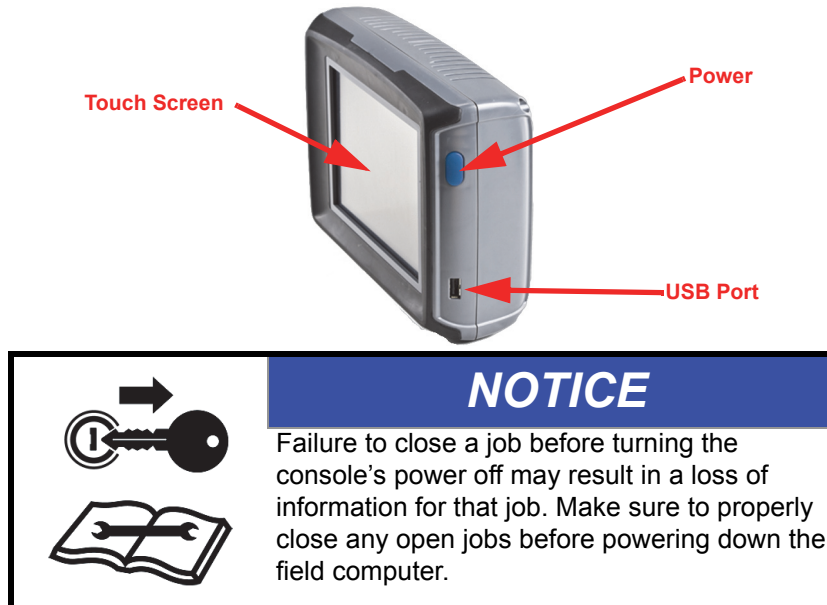

Resistive Touch Screen Technology

Resistive touch screen technology offers clear visibility across a range of lighting conditions and even in direct sunlight while the touch screen functionality places menus and options literally at the operator's finger tips.

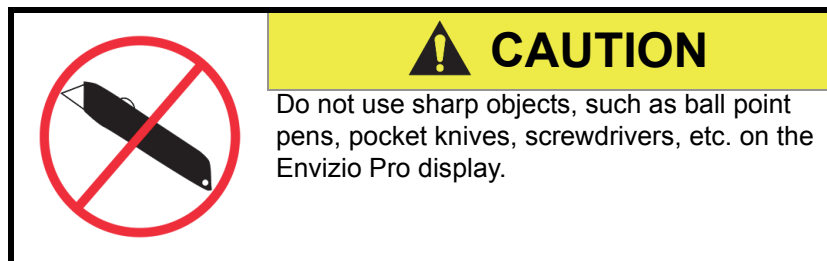

Icon Based Operation

Operation of the field computer can be done at a glance due to the icon based interface. Easily recognizable icons allow the operator to quickly select features or use functions without diverting attention from other important operations.

USB File Transfer

Memory within the field computer is used to store current job and application information. Application information for past jobs should be periodically transferred to a USB flash drive and copied to a home or office PC to view and more permanently store this information. Use a USB flash drive with at least 512 MB of memory (maximum 4 GB) for transferring these files. Storage devices may be purchased at many retail locations or a local Raven dealer.

FIGURE 3. 4 GB USB Flash Drive (P/N 524-0002-065)



Note: *Install the USB flash drive only when transferring files. Do not start the field computer with a flash drive connected or leave the drive inserted during normal operation. For additional information on the available memory resources on specific consoles, refer to the Technical Specifications section on page 12.*

| | |
|--|--|
|  | <p>CAUTION</p> <p>Damage to the field computer may occur if the USB ports are used to charge mobile devices such as cellular phones, tablets, or mp3 devices. The USB ports should only be used for performing file transfer and maintenance.</p> |
|--|--|

Rear Panel

The following is a brief overview of the connections and ports available on the back of the Envizio Pro field computers.

The Rear Panel offers an additional USB Port as well as a port for connecting an optional wireless router for wireless communication. Signal is fed into the internal DGPS receiver through the antenna port located above the mounting posts.



⚠ CAUTION

Damage to the field computer may occur if the USB ports are used to charge mobile devices such as cellular phones, tablets, or mp3 devices. The USB ports should only be used for performing file transfer and maintenance.

The main and auxiliary interface connections are also located on the rear panel. These connections will be used to connect the field computer with the various components and hardware for the specific control system.

FIGURE 4. Envizio Pro Rear Panel Features and Connectors

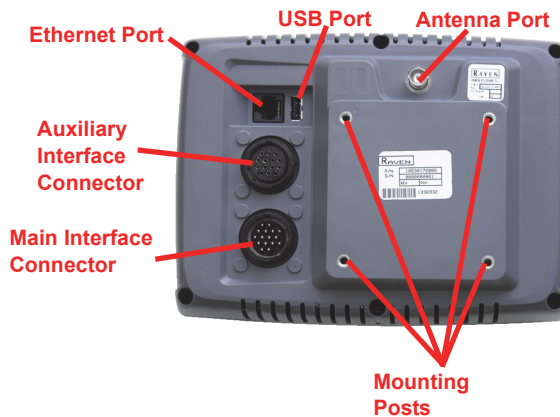

Note: *Envizio Pro field computers without an internal DGPS receiver will not feature an antenna port.*

The part number, serial number and hardware revision of the field computer are located on the tags located on the back of the console. Please have this information available when contacting customer support.

Care and Use

Refer to the following guidelines for proper care and use of the Envizio Pro field computer.

CAUTION

- Do not apply liquid or glass cleaner directly to the surface of the touch screen. Harsh chemicals may damage the touch screen. Clean the touch screen and console exterior as needed with a soft cloth dampened with glass cleaner. Apply the cleaner to the cloth and then wipe the screen gently.
- Do not use a pointed or sharp instrument on the touch screen. Only a fingertip or an approved stylus should be used.
- Do not expose the field computer to precipitation, condensation, or other liquids. Store the computer in a dry environment when not in use.
- Mount the field computer securely and route cables to prevent tripping hazards and to keep the wires from pinching or breaking.
- When temperatures are expected to be 10° F [-12° C] or lower, remove the field computer from the vehicle and store it in a climate controlled environment.
- Always remove the power connections for the field computer and any control nodes from the vehicle battery before jump starting or welding on any vehicle components. Jump starting or welding on the equipment will damage the field computer and nodes.
- Field computer damage may occur if the USB ports are used to charge mobile devices such as cellular phones, tablets, or mp3 devices. The USB ports should only be used for performing file transfer and maintenance.

Technical Specifications

| | | Envizio Pro and Envizio Pro II | |
|----------------------|-----------------------|---|-----------------|
| | | U.S. | Metric |
| Dimensions | Height | 6.26 in. | 15.9 cm |
| | Width | 8.43 in. | 21.41 cm |
| | Depth | 3.46 in. | 8.79 cm |
| | Diagonal (screen) | 6.5 in. | 16.51 cm |
| Weight | | 3.68 lbs. | 1.67 kg |
| Environmental | Operating Temperature | 32° F to 158° F | 0° C to 70° C |
| | Storage Temperature | -4° F to 185° F | -20° C to 85° C |
| Power | Operating Voltage | 9 VDC to 28 VDC Reverse Polarity Protected | |
| Ports | USB | 2 (1 on front, 1 on back) | |
| | Ethernet | 1 (Back) | |
| | Amp | 2 (Back) | |
| Mounting | Plate/Arm | Vesa Plate with RAM Mounting Arm | |
| | Screws (Provided) | 10-32 x 1/2" Long | |

On Board Memory Resources

| Description | Part Number | Hardware Revision | Available Memory |
|-------------------------------------|--------------|-------------------|------------------|
| Envizio Pro (w/o GPS) | 063-0173-315 | A or B | 512 MB |
| Envizio Pro (w/o GPS) | 063-0173-315 | C | 1 GB |
| Envizio Pro II (dual frequency GPS) | 063-0173-301 | A or B | 512 MB |
| Envizio Pro II (dual frequency GPS) | 063-0173-301 | C | 1 GB |

Note: All Envizio Pro field computers with part number 063-0172-865, regardless of hardware revision, provide 512 MB of on board memory resources.

Amp Connector Pin Definitions

**Main Amp
Connection**

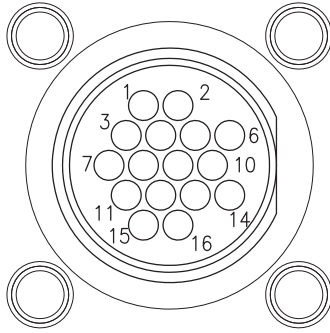

| Main Amp Connector | |
|--------------------|------------------|
| 1. | Battery Negative |
| 2. | Ext. Switch |
| 3. | CAN Hi |
| 4. | CAN Lo |
| 5. | DGPS Receive |
| 6. | DGPS Transmit |
| 7. | DGPS CTS |
| 8. | DGPS RTS |
| 9. | Console Transmit |
| 10. | Console Receive |
| 11. | RS232 Ground |
| 12. | Console CTS |
| 13. | Console RTS |
| 14. | + 12 V Ignition |
| 15. | + 12 V Switched |
| 16. | Battery Positive |
| | |
| | |

**Auxiliary Amp
Connection**

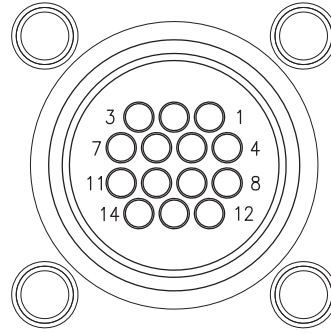

| Auxiliary Amp Connector | |
|-------------------------|--|
| 1. | DGPS Transmit (Corrections In) |
| 2. | Ext. Switch |
| 3. | CAN Hi |
| 4. | CAN Lo |
| 5. | DGPS Receive (To External Devices) |
| 6. | DGPS Transmit (To External Devices) |
| 7. | Auxiliary Receive |
| 8. | Auxiliary Transmit |
| 9. | Auxiliary CTS |
| 10. | DGPS Receive (Corrections In) |
| 11. | Auxiliary RTS |
| 12. | RS232 Ground |
| 13. | Not Used |
| 14. | Radar Out |

Updates

Raven software and documentation updates may be made available periodically on the Raven Applied Technology web site:

www.ravenhelp.com

At Raven Industries, we strive to make your experience with our products as rewarding as possible. One way to improve this experience is to provide us with feedback on this manual.

Your feedback will help shape the future of our product documentation and the overall service we provide. We appreciate the opportunity to see ourselves as our customers see us and are eager to gather ideas on how we have been helping or how we can do better.

To serve you best, please send an email with the following information to

techwriting@ravenind.com

-Envizio Pro™ and Envizio Pro II® Installation and Operation Manual

-P/N 016-0171-493 Rev. I

-Any comments or feedback (include chapter or page numbers if applicable).

-Let us know how long have you been using this or other Raven products.

We will not share your email or any information you provide with anyone else. Your feedback is valued and extremely important to us.

Thank you for your time.

CHAPTER

3

Installation

Overview of the Installation Process

The following is intended as an overview of the installation process. These instructions cover the basic installation of the Envizio Pro and necessary hardware. For additional instructions on installing optional hardware with the field computer, refer to the instructions provided with the optional component(s). Instructions for building a CAN (Controller Area Network) system can be found in Chapter 4, *CAN Networking and Diagnostics*.

Basic installation of the Envizio Pro field computer is as follows:

1. Review kit contents
2. Mount the field computer
3. Mount the DGPS antenna

Kit Contents

Before proceeding with installation of the field computer, review the contents provided with the field computer.

TABLE 1. Envizio Pro II with Scalable GPS Kit Contents

| | | Envizio Pro II with OmniSTAR Ready |
|---|--------------|---------------------------------------|
| Components | Part Number | 117-5010-009VWL ^a |
| Envizio Pro II Field Computer | 063-0173-537 | 1 |
| MBA-6 (Helix) Antenna | 063-0172-651 | 1 |
| Antenna Cable (20') | 115-0171-787 | 1 |
| Aerial Antenna Mounting Plate (Optional) | 063-0172-971 | 1 |
| Mounting Kit (includes Hardware) | 117-0171-132 | 1 |
| OmniSTAR XP/HP Authorization Code ^b | 077-0180-081 | 1 |
| Envizio Pro Installation and Operation Manual | 016-0171-148 | 1 |
| Envizio Pro Quick Reference Guide | 016-0171-149 | 1 |

- a. The kit letter indicates the included options for internal receiver correction source(s). 'VWL' kits are enabled for SBAS only.
- b. OmniSTAR or GS activation and subscription must be purchased separately if not included with the kit.

TABLE 2. Envizio Pro with Switch Pro Kit Contents

| | | Envizio Pro II with SBAS | Envizio Pro without GPS Receiver |
|---|--------------|-----------------------------|-------------------------------------|
| Components | Part Number | 117-0171-382 | 117-0171-383 |
| Versatile Envizio Pro II Field Computer with Built-in Receiver | 063-0173-301 | 1 | |
| Versatile Envizio Pro Field Computer without Built-in Receiver | 063-0173-315 | | 1 |
| Versatile Switch Pro Kit | 117-0171-381 | 1 | 1 |
| Envizio Pro to Switch Pro Cable | 115-0171-821 | 1 | 1 |
| MBA-6 (Helix) Antenna | 063-0173-317 | 1 | |
| Antenna Cable (20') | 115-0171-787 | 1 | |
| Mounting Kit (includes Hardware) | 117-0171-132 | 1 | 1 |
| Envizio Pro Installation and Operation Manual | 016-0171-493 | 1 | |
| Envizio Pro Quick Reference Guide | 016-0171-494 | 1 | |

FIGURE 1. Envizio Pro Kit Contents (Drawing Number 054-2040-004)

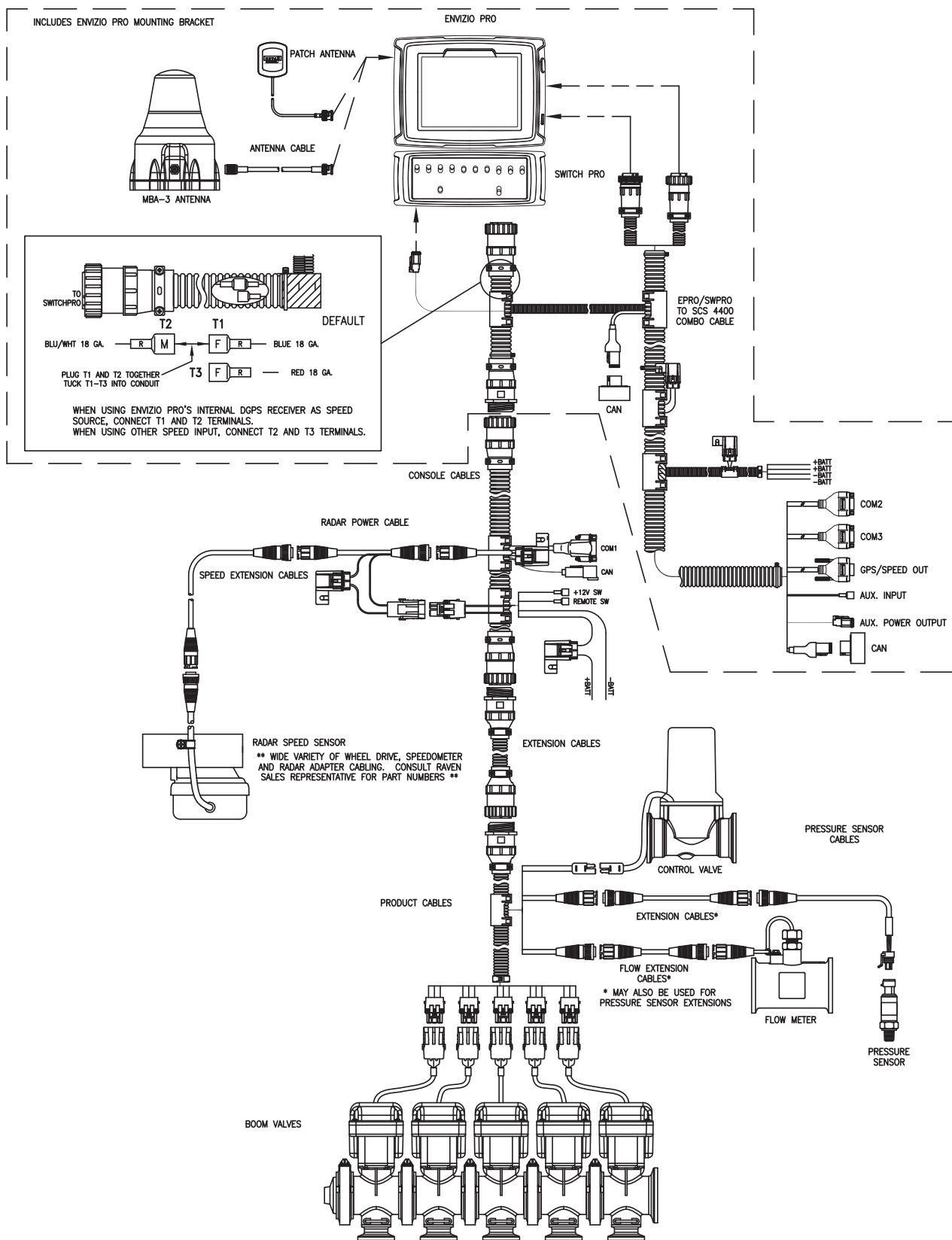

Mounting the Field Computer

Refer to the following requirements when selecting a mounting location for the Envizio Pro field computer:

- Mount the field computer inside of the machine cabin or driver compartment within easy reach of the driver or operator. The field computer is not weatherproof.
- Securely fasten the RAM mounting arm to a suitable, flat surface. Once mounted, the RAM mounting arm must provide a stable base for the console and should not impede normal machine operation.
- Mount the field computer in a location where it will not be jarred during normal equipment operation. Keep the computer clear of moving elements within the machine's cab.
- Route all cables to avoid tripping hazards and protect the cable from kinking or breaking during operation.

To mount the Envizio Pro or Envizio Pro II field computer:

Note: If the CAN Switch Box will be installed with the Envizio Pro field computers, use the mounting hardware provided with the CAN Switch Box. Refer to the CAN Switch Box Installation and Operation Guide for mounting instructions.

1. Mount the circular base of the RAM socket arm (P/N 117-0171-132) securely within the cab of the vehicle.
2. Using the four mounting posts and supplied hardware, secure the field computer to the square plate of the RAM mounting arm.

FIGURE 2. Envizio Pro and Envizio Pro II Rear Panel

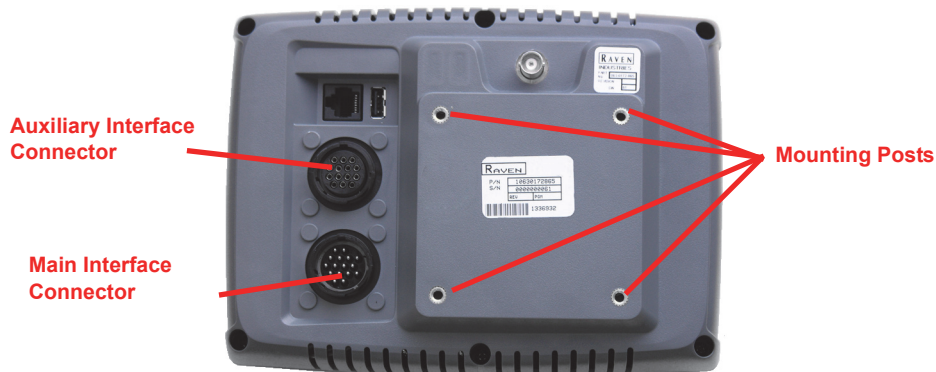

3. Insert the ball mounting posts into the socket mounting arms and tighten the hand screw to secure the field computer at the desired mounting location.

Cable Platforms and Connections

Two cable platform options are available for use with the Envizio Pro field computers. Each platform offers a range of optional features which can be added to the control system at any time.



NOTICE

Please review the *Raven CANbus Network Installation Manual* for installation instructions for the specific cable platform being installed with the field computer prior to beginning installation. Contact a local Raven dealer for assistance or to purchase additional components necessary to set up the CANbus system.

Generation 1 Cable Connections

Important: Ensure that the Envizio Pro field computer has been properly mounted and all component cabling is connected properly before connecting the Envizio Pro to power.

FIGURE 3. Generation 1 Main Interface Cable Connection Diagram

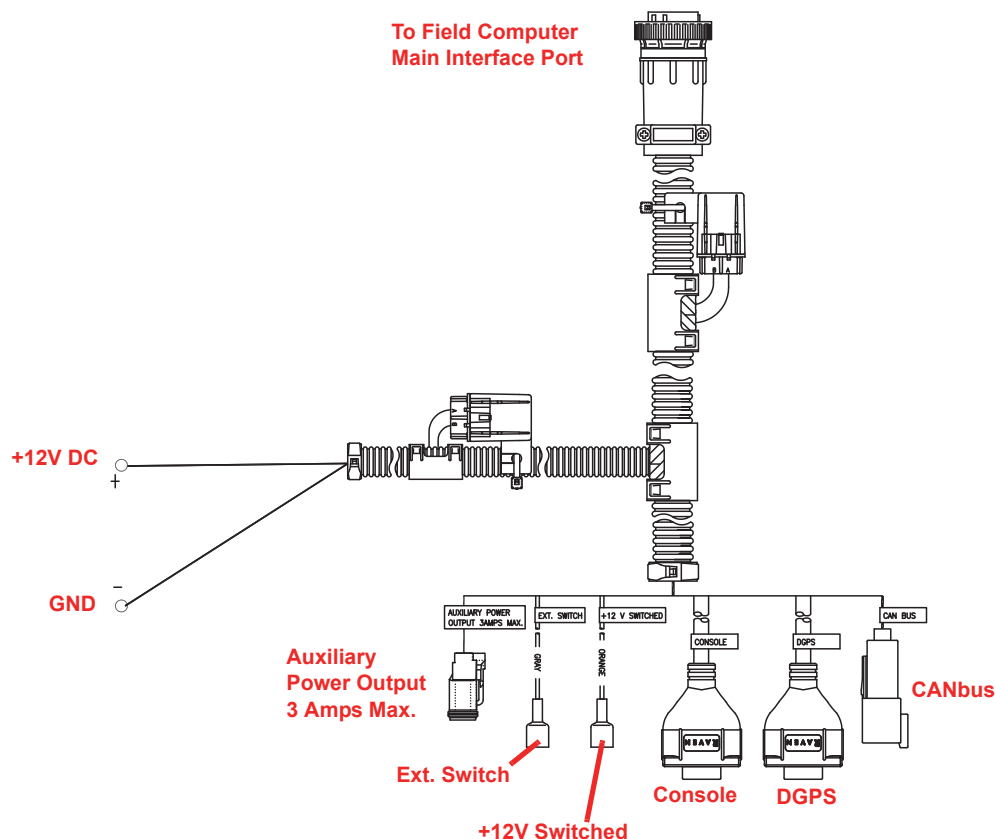

1. Route the conduit with red and white leads to a clean, controlled power source such as a clean power bus bar or junction box.

2. Connect the red lead wire to a clean +12V DC power source.

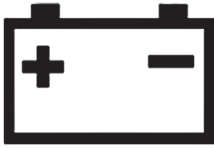
| | |
|---|----------------|
|  | CAUTION |
| Even when the field computer is powered off, the computer will draw a small current from the battery. Connect the red wire to a controlled power source or, if the machine will not be in use for an extended period of time, remove power from the field computer. | |
| To prevent accidental data loss, the red wire should be connected to a clean power source. | |

3. Connect the white wire to ground.

Note: Do not connect the orange wire to external power. The orange wire is switched power out of the field computer. When the field computer is powered, +12V DC is applied to the orange wire to power an external device. If more than one amp is required to power a device connected to the orange wire, install a relay to switch the higher currents.

FIGURE 4. Relay (P/N 415-1001-009) Terminals

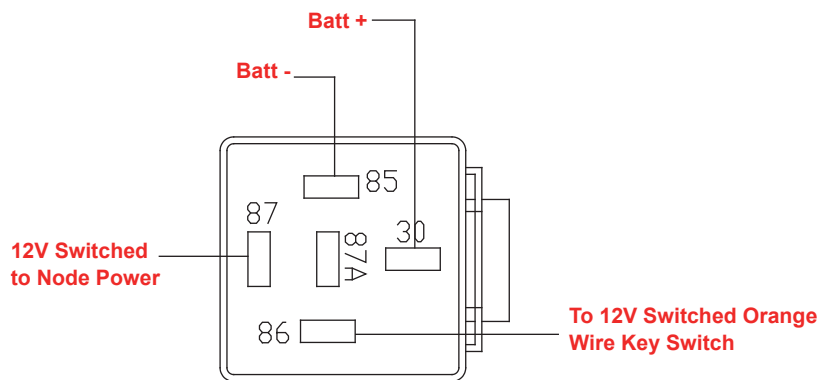

Generation 2 Cable Connections

The chassis cable platform requires the following components:

- Machine specific chassis cable
- Envizio Pro chassis interface cable (P/N 115-0172-001)
- CAN Switch Box kit (P/N 117-5020-001)

Note: Contact a local Raven dealer for switch box options. Refer to the Raven CANbus Network Installation Manual for additional cabling information for the generation 2 cable platform.

FIGURE 5. Generation 2 Cable Connection Diagram (Drawing Number 054-5000-001)

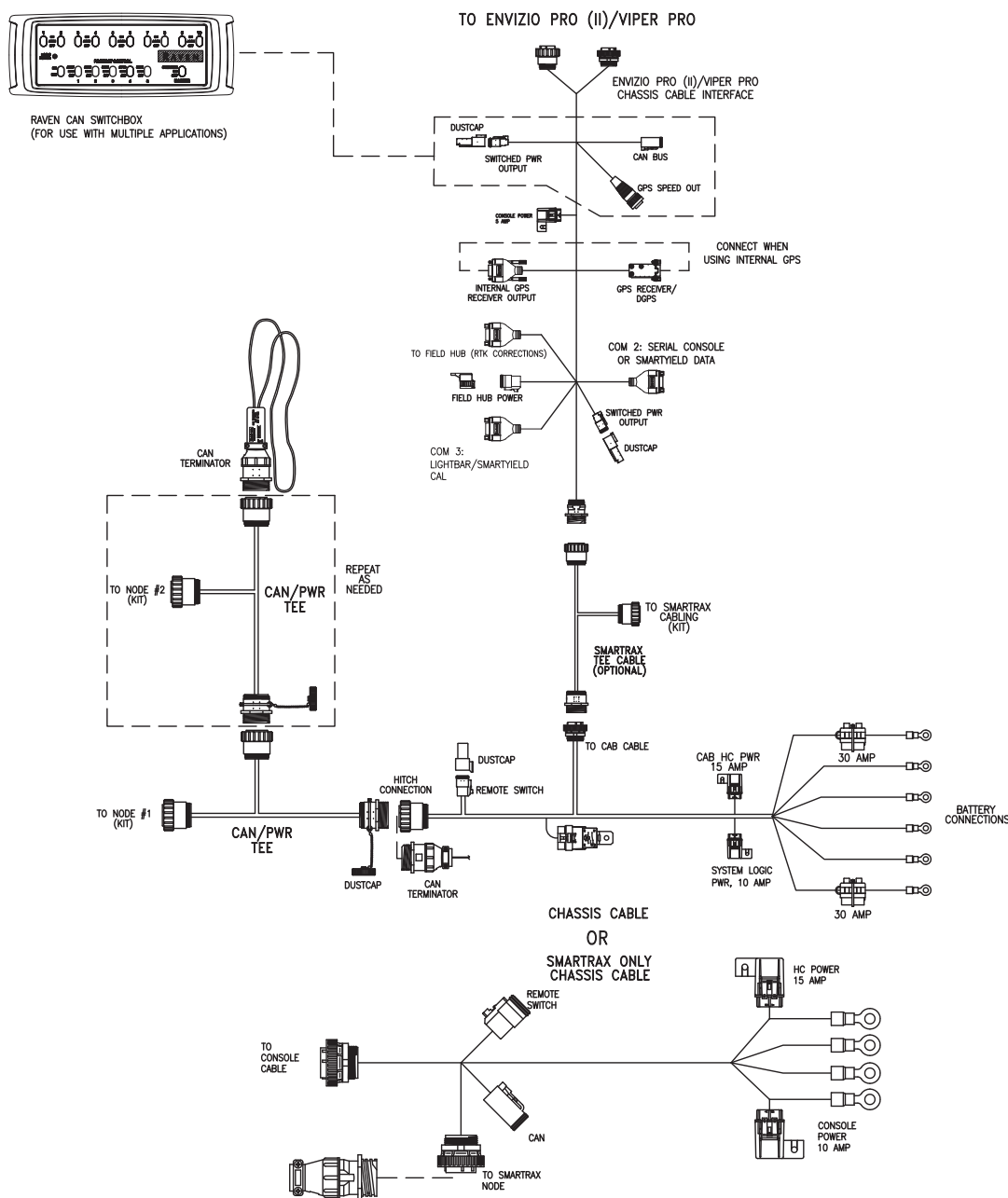

Note: The CAN Switch Box is not used with the optional Raven OmniRow system.

Chassis Interface Cable and CAN Switch Box Connection

Note: *The CAN Switch Box and switch box mounting bracket should be mounted to the Envizio Pro field computer prior to beginning the following procedure. Refer to the CAN Switch Box Installation and Operation Guide for detailed instructions.*

1. Locate the single round connector labeled 'To Chassis or SmarTrax Tee Cable' on the Envizio Pro/Viper Pro chassis interface cable (P/N 115-0172-001).
2. Insert this connector into the 'To Cab Cable' on the chassis cable installed on the vehicle. Thread the connectors together to secure the connection.
3. Route the end of the cable with two round connectors to the back of the Envizio Pro and connect to the main and auxiliary ports.
4. Connect the 2-pin Deutsch connector labeled 'Switched Power Output' to the back of the CAN Switch Box.
5. Connect the 4-pin Deutsch connector labeled 'CANbus' to the back of the CAN Switch Box.
6. Connect the 3-pin round connector labeled 'GPS Speed Out' to the back of the CAN Switch Box.

Note: *Disconnect the 3-pin 'GPS Speed Out' connection if using GPS speed over CAN as the speed source. Refer to the Speed Cal section on page 187 for additional assistance with speed sensor types and speed calibration values.*

If the chassis interface cable (P/N 115-0172-001) is installed and the internal DGPS receiver will be used for DGPS reception, the 'Internal GPS Receiver Output' and 'GPS Receiver/DGPS' port connectors must be connected together.

DGPS Antenna

Note: *To enable the guidance capabilities of the field computer, DGPS signal must be supplied by one of the following:*

- The internal DGPS receiver
- An optional external receiver capable of outputting messages at a minimum of 10 Hz.

For more information on configuring the Envizio Pro or Envizio Pro II field computers for one of the above options, see Chapter 7, Tools Menu.

With the internal receiver, the Envizio Pro or Envizio Pro II only requires a connection to a DGPS antenna in order to create application maps. To ensure the best possible signal reception, the following recommendations should be considered when selecting the DGPS antenna mounting position.

- Mount the DGPS antenna to the tallest point of the vehicle (usually the vehicle's cab) using the standard magnet mount.
- Make sure that the DGPS antenna has a clear 360° view of the sky.
- Mount the DGPS antenna at least of 36" [92 cm] from other antennas (e.g. radio, cellular, etc.) to avoid signal interference.
- The simplest setup is achieved by mounting the antenna on the center-line of the vehicle.

Aerial Antenna Mounting Plate (Optional)

An optional aerial antenna mounting plate (P/N 063-0172-971) is included with field computers featuring a helix style antenna. If no suitable magnetic mounting location exists on the vehicle, this mounting plate may be affixed to the tallest point of the vehicle to provide a magnetic surface for mounting the GPS antenna.

Connecting the Antenna to the Internal DGPS Receiver

1. (Helix antennas only) Connect the antenna cable (P/N 115-0171-787) to the antenna.
2. Route the cable into the cab and connect to the antenna port on the back of the field computer.

FIGURE 6. Antenna Port for Internal DGPS Receiver

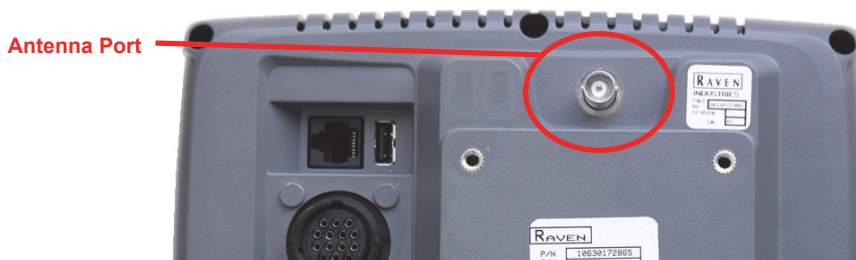

Note: *Envizio Pro consoles without the internal DGPS receiver will not feature the antenna port.*

3. If the chassis interface cable (P/N 115-0172-001) is installed and the internal DGPS receiver will be used for DGPS reception, the 'Internal GPS Receiver Output' and 'GPS Receiver/DGPS' port connectors must be connected together.

FIGURE 7. Envizio Pro and Envizio Pro II Antenna Options for Internal DGPS Receivers

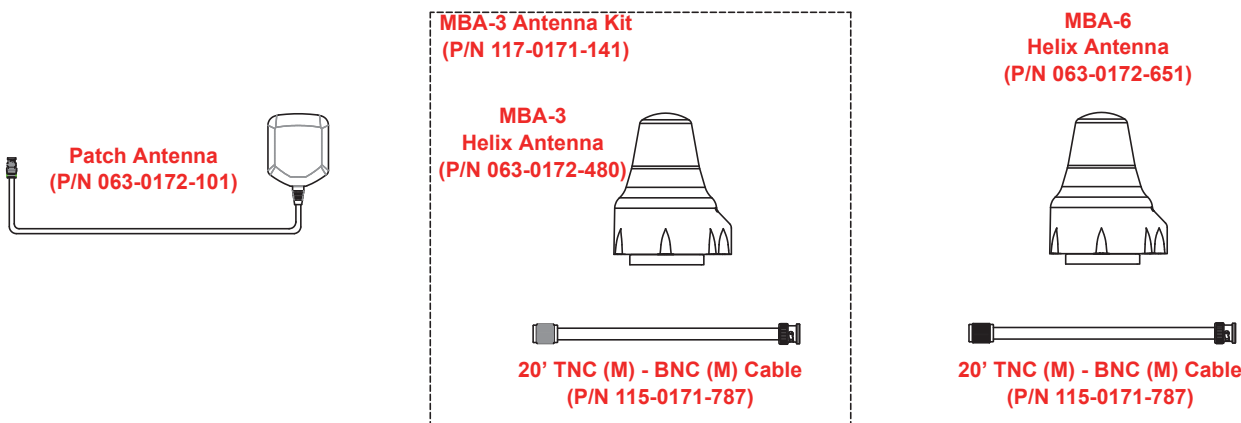

Note: *The Envizio Pro II requires an MBA-6 helix antenna (P/N 063-0172-651) for use with RTK, GS, or OmniSTAR correction sources with the internal GPS receiver.*

Connecting External DGPS Receiver Systems

1. Follow installation instructions included with any optional or additional external DGPS components before connecting to the field computer or related cabling.
2. Signal from an external DGPS receiver must be routed into the field computer via the connector labeled 'GPS Receiver' or 'DGPS' on the main interface cable (P/N 115-0171-746) or chassis interface cable (P/N 115-0172-001).
3. For help with setting up the field computer to use the signal from an external receiver, refer to Chapter 7, *Tools Menu*.

Installing Optional Equipment

The following sections offer descriptions of optional hardware or configurations in which the Envizio Pro is capable of operating.

Boom Sense Wire

The boom sense wire may be connected to the master switch functions of the machine to allow seamless operation of vehicle master on/off and the field computer mapping feature.

If the boom sense wire is properly connected, the vehicle master on/off switch also toggles the product coverage mapping based on a +12V signal detected on this wire.

Generation 1 Cabling

Connect the spade connector on the main interface cable (P/N 115-0171-746) labeled “Ext. Switch” (external switch) to the machine master switch.

FIGURE 8. Main Interface Cable (P/N 115-0171-746) Boom Sense Wire Connection

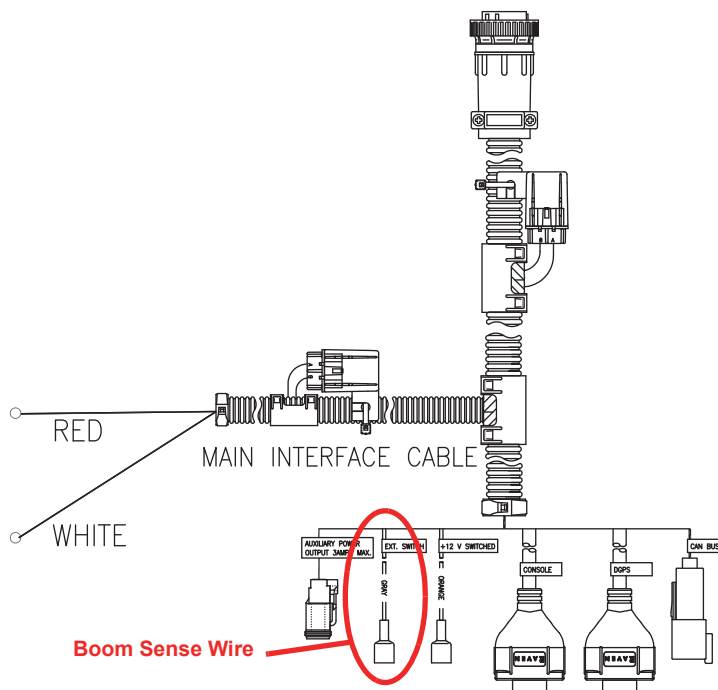

Note: Contact the machine manufacturer for more information on connecting the boom sense wire on the specific machine.

Generation 2 Cabling

Connect the spade connector on the main interface cable (P/N 115-0172-001) labeled “Ext. Switch” (external switch) to the machine master switch.

FIGURE 9. Field Computer Cabin Cable (P/N 115-0172-001) Boom Sense Wire Connection

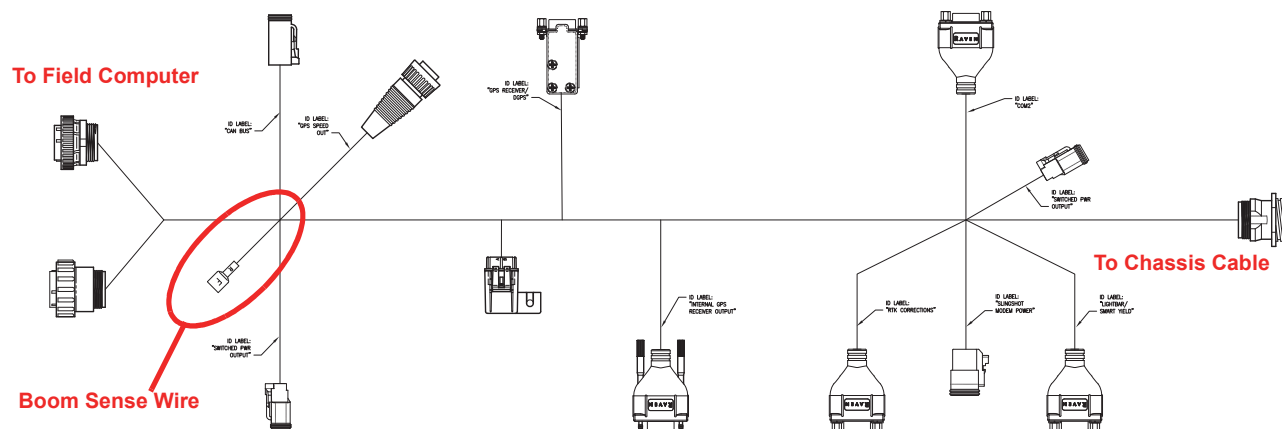

Note: Revision A or B cabin cables may not provide the purple boom sense wire. Contact a local Raven dealer for additional options or to replace the cable.

Contact the machine manufacturer for more information on connecting the boom sense wire on the specific machine.

AccuBoom™

Refer to the machine specific installation materials for instructions on installing AccuBoom on the machine.

Note: When used with a CAN product control system, AccuBoom requires a boom/speed node with program D or newer for proper AccuBoom functionality.

AccuBoom™ Master Switch

The AccuBoom master switch option will allow AccuBoom to toggle coverage mapping and section information as reported by the AccuBoom node.

To enable the AccuBoom master switch, connect the orange wire with white stripe on the AccuBoom node harness to the machine master switch. Contact a local Raven dealer for more information on part numbers and availability of the AccuBoom feature for the specific sprayer model.

Contact the machine manufacturer for more information on connecting this feature.

Light Bar

Envizio Pro field computers are capable of interfacing with an external Raven light bar through the auxiliary interface cable (P/N 115-0171-745) or the chassis interface cable (P/N 115-0172-001).

If an external light bar is desired, follow the installation instructions provided with the light bar before connecting the light bar to the field computer. Once installation of the light bar is complete, connect the light bar cable to the serial connector labeled 'COM 3' on the appropriate interface cable. See Chapter 7, *Tools Menu*, for information on configuring the field computer to send messages to the external light bar.

TM-1 Tilt Module

GPS receivers output position information relative to the position of the DGPS antenna. Most often, the antenna is mounted on the top of the machine which means the GPS location is only accurate when the machine is on level ground. On uneven terrain, such as side hills, the actual ground position may differ from the location of the GPS antenna.

FIGURE 10. Reported GPS Position Error Due to Side Hill

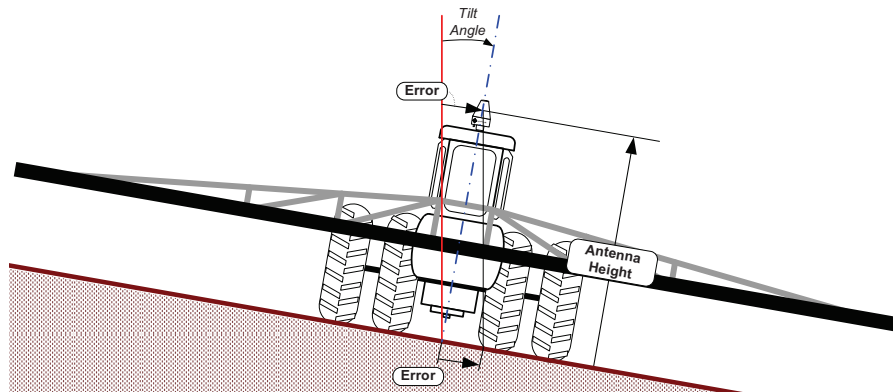

The Raven TM-1 Tilt Module compensates for any tilt of the vehicle from a level field condition. To supply tilt compensated GPS signal, the Raven TM-1 Tilt Sensor receives a raw DGPS signal from the DGPS receiver and outputs a tilt corrected signal to guidance devices or controllers.

If connected directly to the 'DGPS' connector on the main interface cable (P/N 115-0171-746) or chassis interface cable (P/N 115-0172-001), the field computer may be used to configure the TM-1. Refer to the TM-1 Tilt Module Installation and Operation manual for details and installation diagrams for installing the Tilt Module with the Envizio Pro field computer.

Note: See the *System Menu* section on page 93 for information on setting up the TM-1 using the field computer.

When routing tilt corrected signal through a SmarTrax controller and back into the Envizio Pro, the TM-1 will need to be calibrated through the SmarTrax controller rather than the field computer. See the SmarTrax Quick Start Guide or Operator's Manual for more details on setting up and operating the TM-1 with a SmarTrax controller.

SmarTrax™

Envizio Pro field computers are capable of operating with optional Raven hydraulic and mechanical drive assisted steering systems such as Raven SmarTrax or SmarTrax MD.

GPS signal is routed into the SmarTrax controller and then fed into the field computer via the 'DGPS' connector on the Envizio Pro main interface cable (P/N 115-0171-746) or chassis interface cable (P/N 115-0172-001).

When the SmarTrax system is engaged, the assisted steering system controls the vehicle steering system, either hydraulically or by mechanically turning the steering wheel, to guide the vehicle along a guidance path displayed on the field computer Guidance screen. See the *Source* section on page 133 to configure the Envizio Pro to use an optional SmarTrax system.

Serial Console

FIGURE 11. Envizio Pro Gen 1 Cable Platform with Serial Control Console

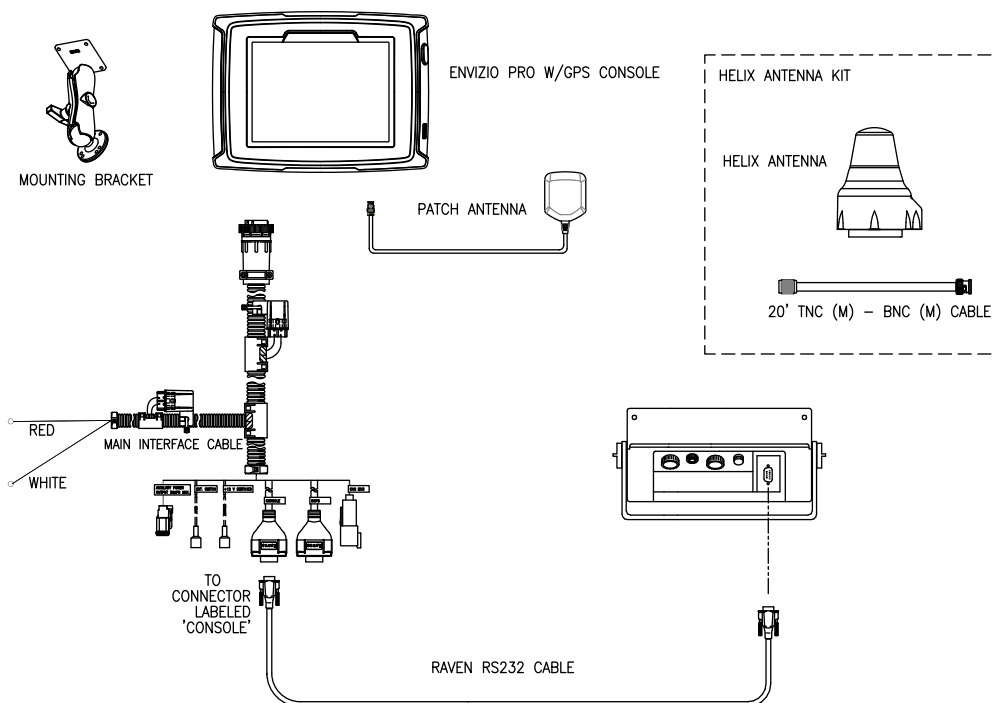

The Envizio Pro may be connected to a Raven serial control console via a serial port connection. In this configuration, the field computer is primarily used for the data logging, mapping, and guidance.

Note: *If connected to a serial control console, the field computer does not require a separate boom/speed or product control node. An AccuBoom, AutoBoom, or SmarTrax node still may be connected to the field computer.*

Chapter 3

Use one of the following Raven RS-232 cables to connect the serial port on the back of the serial control console to the connector labeled 'Console' on the Envizio Pro interface cable.

| Description | Part Number |
|-----------------------|--------------|
| RS-232 cable - 3 ft. | 115-0171-040 |
| RS-232 cable - 10 ft. | 115-0159-822 |

Note: Use only a Raven RS-232 communication cable between the field computer and the serial control console. Contact a local Raven dealer for purchasing and more information.

See Chapter 7, *Tools Menu*, to setup the field computer for the serial console connection.

AutoBoom®

Follow the machine or implement specific installation manual to install the AutoBoom hydraulic valve and hoses.

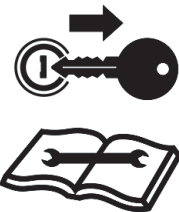
| | |
|---|--|
|  | <p style="text-align: center;">NOTICE</p> <p>Read all safety requirements and precautions in the machine specific installation manual prior to operating a machine equipped with the AutoBoom feature. Failure to follow safety precautions may lead to damage to equipment, injury or death.</p> |
|---|--|

CANbus Network Connection

Envizio Pro field computers are capable of controlling up to four product nodes or control channels (with required activation keys) on a CANbus system. The field computer will automatically scan for CAN product control, planter control, AccuBoom, AutoBoom, SmarTrax, boom sense and speed nodes connected through the CAN connection.

See Chapter 4, *CAN Networking and Diagnostics*, or the Raven CANbus Installation Manual, for additional information.

CHAPTER

4

CAN Networking and Diagnostics

A Controller Area Network, or CAN, system is a high-integrity serial data communications bus that operates at a data rate of 250 kilobits per second for real-time control applications and uses special cables and terminators for operation. The CAN protocol has excellent error detection and confinement capabilities, making it very suitable and reliable for agricultural applications.

CAN systems allow products to be added to a control system at any time. Up to four product control nodes or control channels can be connected to the Envizio Pro control system for any combination of liquid, granular, chemical injection or spinner control applications.

The diagrams in this chapter show different hardware configurations for use with Envizio Pro series field computers. Some diagrams show optional features which may not apply to each system. These features and components are not required for CAN operation and optional features and cables may be ignored during a basic installation.



NOTICE

Refer to the *Raven CANbus Network Installation Manual* for installation information for individual CANbus control components. Be sure each component is properly mounted and cables are connected prior to powering the field computer.

FIGURE 1. Envizio Pro Dual Product (Liquid/Granular) CAN Control System

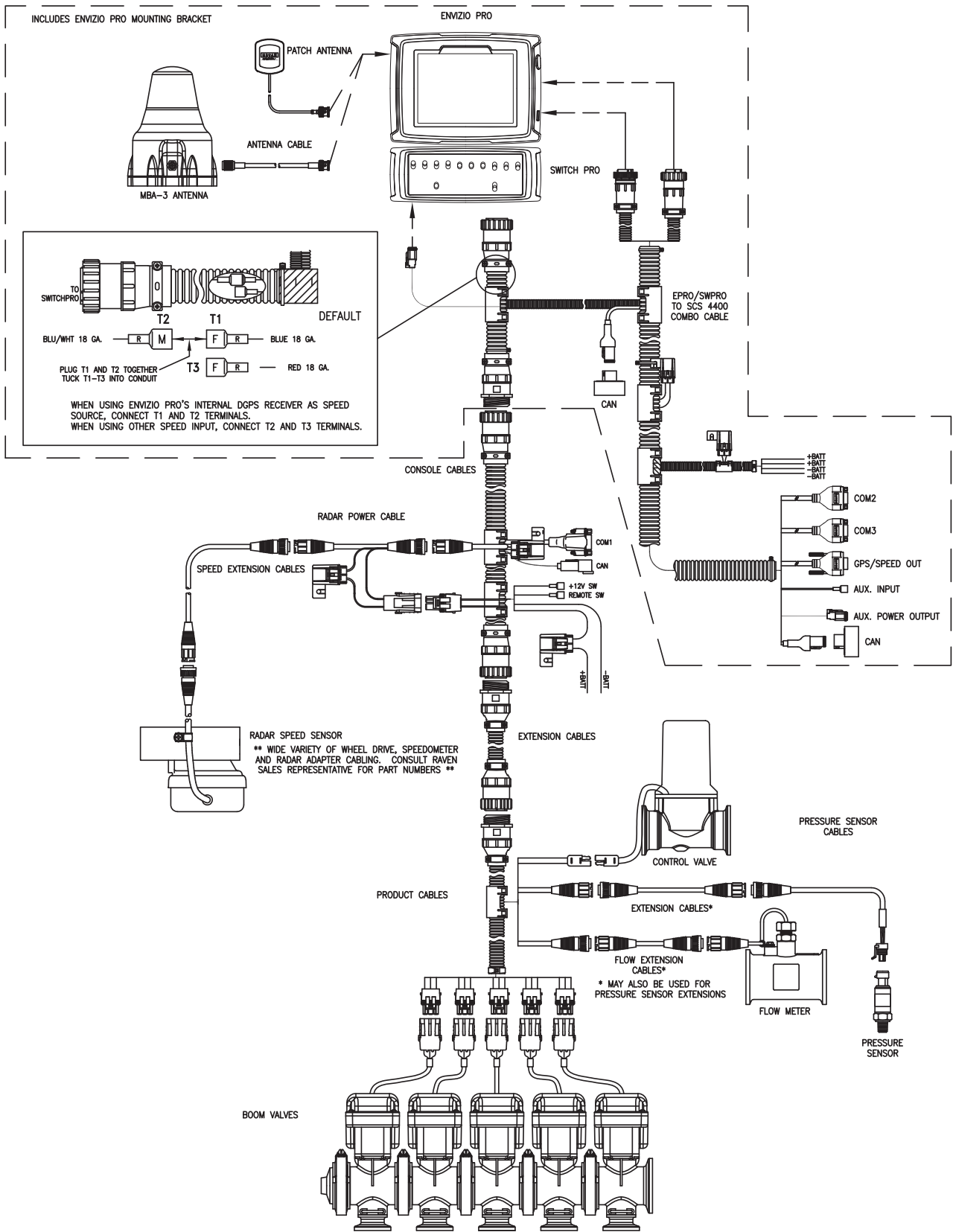

CAN Diagnostics

The field computer must be able to communicate with the CANbus system when monitoring or controlling product application. If configured as a CAN control console, the Envizio Pro should automatically establish communication with the boom/speed node, the AccuBoom, AutoBoom, or SmarTrax Terrain Compensation nodes (if installed), and up to four product control nodes via the CANbus.

Note: Product nodes may need to be readdressed prior to detecting each node on the CANbus. See the *Readdressing Product Nodes* section on page 31 for detailed instructions on readdressing the product nodes.

Contact a local Raven dealer for more information on required activation keys for controlling up to four products using the Envizio Pro field computers.

To view a list of nodes currently detected on the CANbus network:

1. Select the Information icon in the upper, right corner of the Home screen.



2. Touch the  icon on the About Envizio Pro screen to display the CAN Diagnostics screen.

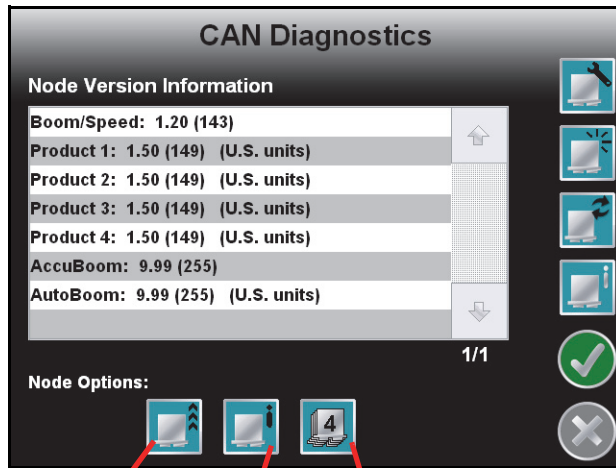

Update Nodes Node Hardware Information Select Channels

Readdress Nodes
Reset Defaults
Retry CAN Communication
Service Mode

Note: If a product is not found, troubleshoot the node to determine why the field computer cannot communicate with the node. See the *CAN Troubleshooting* section on page 34 for more information about CAN communication failures.

Node Version Information

The CAN Diagnostics screen displays the software version, software revision and program number of each node detected on the CANbus.

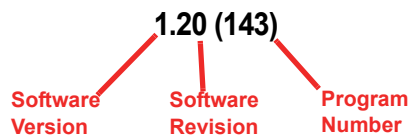

Readdressing Product Nodes

If the field computer is unable to detect a CANbus node on startup, troubleshoot the CANbus and the node (see the *CAN Troubleshooting* section on page 34) and then readdress the CANbus:

Note: Only nodes controlling product application will need to be addressed if multiple product nodes are on the CANbus (e.g. single product, dual product, motor control, planter control, etc.).

1. Select the Information icon in the upper, right corner of the Home screen.



2. Touch the  icon on the About Envizio Pro screen to display the CAN Diagnostics screen.

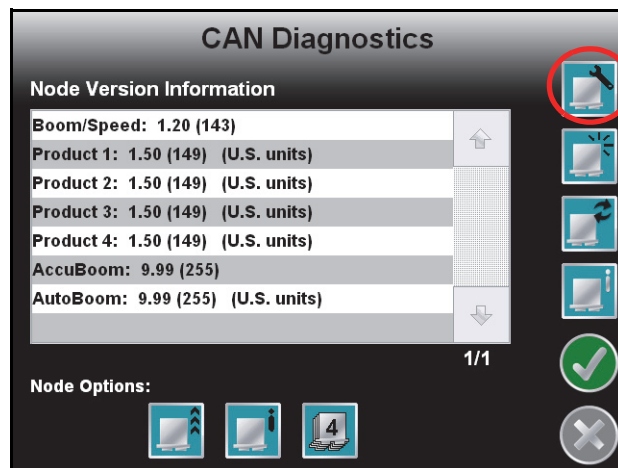



3. Touch the  button to begin readdressing the product control nodes.
4. When prompted to cycle power on the first product node, disconnect the logic power from the product node to be controlled as Product 1. After approximately 3 seconds, reconnect the node logic power. The field computer should have recognized the node as 'Product 1.'
5. If additional product nodes are installed in the CANbus, repeat step 4 to readdress the remaining product nodes as necessary.
6. Touch the Accept icon to finish readdressing the product nodes.

Reset CANbus Defaults

| | |
|--|---------------|
|  | NOTICE |
| <p>Resetting system defaults will clear all calibration information from any product control nodes. Before resetting system defaults, it is recommended to write down any necessary calibration information that may help to recalibrate the system.</p> | |

To reset all product control nodes on the system:

1. From the Home screen, touch the Tools Menu icon and access the Control Interface screen from the System menu.
2. Touch the  icon along the right side of the screen to access the CAN Diagnostics screen.
3. Touch the  button to clear all product node or control channel settings. Use the *Calibration Reference Sheet* section on page vii if necessary to record the required calibration values for system operation. To help record additional settings for each node, step through or review the *Product Control Setup Wizard* section on page 44.
4. Touch the Accept icon to proceed with the system reset or select the Cancel icon to return to the CAN Diagnostics screen without resetting the CANbus system.

Note: Refer to the *Product Control Setup Wizard* section on page 44 for assistance recalibrating the product control nodes.

Retry CAN Communication

If a node currently connected to the CANbus system is not displayed on the CAN Diagnostics screen, touch the  button to start the CAN system. If the node still does not appear on the CAN Diagnostics screen, the CANbus system may need to be readdressed. Review the *Readdressing Product Nodes* section on page 31 for instructions on readdressing the product nodes.

Service Mode

The service mode is intended for use by a trained Raven technician and may be used to assist with troubleshooting and diagnostics. Contact a local Raven dealer for additional assistance.

Additional Node Options

The following features or options may also be available via the CAN Diagnostics screen:

Select Control Channels



The Raven product controller node is capable of providing up to four product control channels on an Envizio Pro control system. By default, the product controller will make two control channels available to the field computer for controlling product application.

Select one of the product controller node channels and select the Select Channels icon (shown to the left) to set the number of control channels available via the node.

Note: *The Select Channels icon will display the current number of channels which the node is providing to the field computer. Each control channel must be configured separately via the Tools Menu.*

Hardware Summary



Select a node from the list displayed on the CAN Diagnostics screen and touch this icon to view detailed node hardware information if available. The hardware summary screen provides node operating information that may be helpful when contacting technical support or while troubleshooting CAN communication issues.

Note: *If the node is not capable of providing hardware information, the Hardware Summary screen will display "N/A" for the unavailable diagnostic values.*

Update CAN Nodes



Select a node from the list displayed on the CAN Diagnostics screen and touch this icon to update the node firmware via the CANbus network using the field computer. Refer to Appendix E, *Updating CAN Nodes via the Envizio Pro*, for additional assistance performing a node update using the field computer.

CAN Troubleshooting

Although the control algorithm is located within the CAN node, all of the same troubleshooting techniques that are used in a traditional hard-wired or serial control systems still apply to a CAN system and the behavior of the system remains the same. Flow and speed sensors, as well as the control valve and boom valves, are used in the same fashion.

CAN Node Off-line Errors

Occasional reports have been received on Raven consoles sporadically losing communication with one or more CAN nodes. The most likely causes for this problem are:

1. Corroded and/or open connections in the circuit.
2. Computer and/or CAN node logic power and grounds connected to a “dirty” power source (dirty power is defined as any circuit with a variable load that exceeds 1 ampere). This is especially true of circuits loaded by electrical coils.
3. Computer and/or nodes connected to different power and/or ground sources. This can result in components operating at different voltage planes.

Refer to the Raven CANbus Network Installation Manual for detailed troubleshooting procedures and information.



CHAPTER

5

Startup, Initial Setup, and Setup Wizards

Overview

The first time the Envizio Pro field computer is powered up, the field computer will require some information about the machine, implement, and the type of applications, products and additional features connected to the system. The field computer gathers this information through a setup wizard which will prompt the user to input the required information to setup the computer for the first time.

Initial Setup

The initial setup wizard will automatically begin when the console is powered up for the first time. This process should only take a few minutes to complete and is only required during the initial power up sequence.

Note: *If the field computer displays an alert regarding an authorization code after starting the console, contact a local Raven for assistance. Refer to the Special Features Registration section on page 138 for instructions on entering the authorization code.*

The initial setup wizard will require the following vehicle information:

- Desired language and display units for operation.
- Guidance width (width of boom or implement without fence row nozzles, foam markers, etc.).
- Antenna offsets (left/right, fore/aft) and height.
- Whether the field computer will be interfacing with a CAN system, another Raven serial console, or none of these systems.
- How the boom master switch operation should be monitored by the field computer.

Other Required Wizards

Additional wizards may be required during the initial startup depending upon the settings and selections entered during this process. Detailed descriptions of those wizards are also available in this chapter.

Launching Wizards

To start the setup wizards after the initial power up has been completed, select the wizard icon in the upper left corner of the Tools menu.

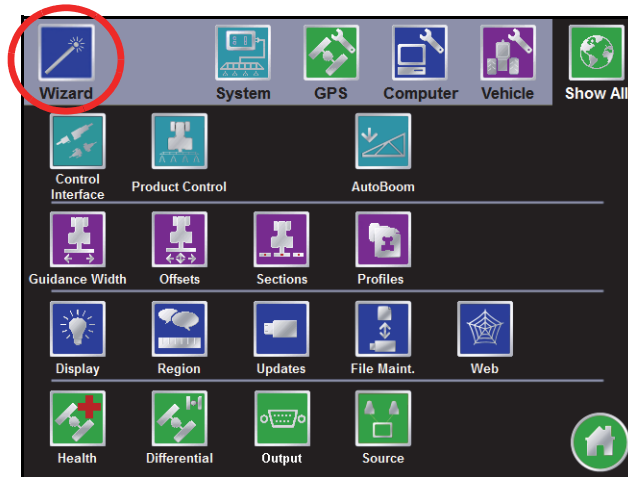

See the *Setup Wizards* section on page 42 for a detailed description of the other available wizards.

Startup

The Envizio Pro field computer will take several seconds to power up and initialize the user interface, DGPS reception and the other features of the system.

During startup, the field computer will display the following prompt.

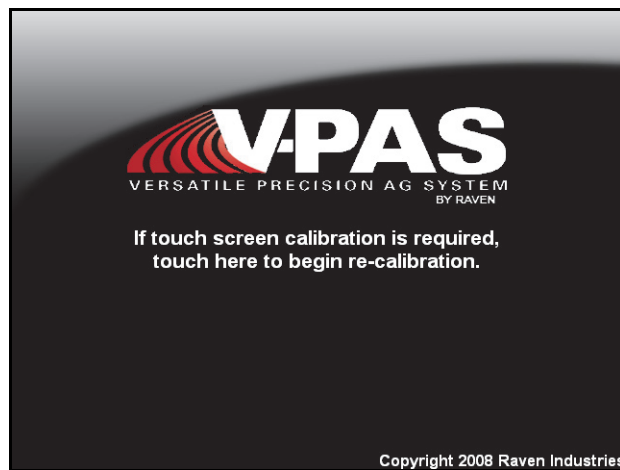

Ignore this prompt to allow the field computer to startup normally.

Note: To launch the touch screen calibration wizard, touch the screen while this prompt is displayed.

Touch Screen Calibration

The touch screen displays an arrow in the location last selected. If the arrow does not appear in the location previously touched, the touch screen may need to be recalibrated.

Note: *The Envizio Pro does not require re-calibration of the touch screen every time the console is powered on. Use this procedure only if you are having difficulty with the user interface or the cursor appears in a different location than selected on the touch screen.*

To Re-calibrate the Touch Screen

1. When prompted, touch the screen to begin re-calibration of the touch screen. The first calibration target will appear.

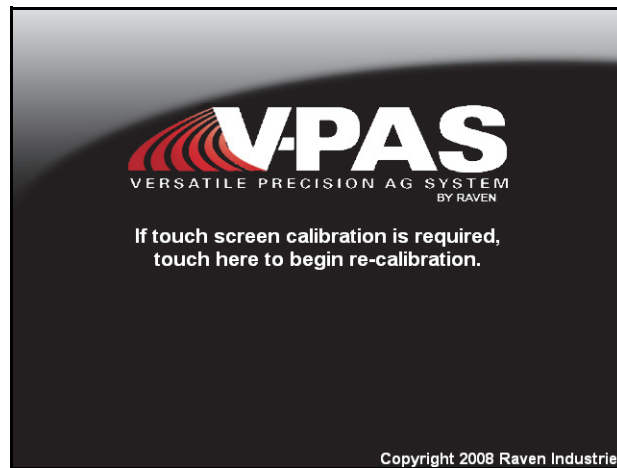

Note: *The operator has approximately seven seconds to touch the screen to begin the calibration process.*

2. Touch the center of the target.

Note: *Each of the four following targets will require the operator to touch the center of the target.*

3. After all of the calibration targets have been completed, test the touch screen calibration by touching in various areas of the screen.
4. Two options will appear in the lower left corner of the screen:
 - Touch 'Accept' to apply the screen re-calibration and start the field computer.
 - Touch 'Cancel' to reject the screen calibration. The field computer will re-apply the previous touch screen calibration before starting the Envizio Pro management software.

Initial Setup Wizard

The initial setup wizard will automatically begin when the Envizio Pro is powered up for the first time. This wizard will step through the initial settings and calibration values required for operation of the field computer and control system. This process is only required during the initial power up sequence.



Any values or settings programmed during the initial setup wizard may be modified or refined later through the Tools Menu.

Note: *Many of the values entered in the initial setup wizard are required for guidance and/or product control features of the control system. Therefore, the more accurate these values, the more accurate the control system will be.*



Review the following steps and sections for assistance with completing the initial setup wizard. To confirm the settings displayed on a screen and proceed with the initial setup wizard, touch the 'Next' or 'Accept' icons. If available, the 'Previous' icon will step back to the previous Setup screen.





Note: *The following steps are provided as a process overview. The following procedure will reference specific sections in Chapter 7, Tools Menu, for details on specific settings and configuration assistance.*

1. The Region screen is displayed automatically when the field computer is powered on for the first time. Select the preferred language and units for display on the field computer. Refer to the *Region* section on page 137 for details on the available settings or region selections.
2. If desired, configured the time zone by selecting the Time Zone  icon in the upper, right corner of the Region screen. Refer to the *Time Zone Settings* section on page 137 for details.
3. Touch the Next  icon proceed with the initial field computer setup.
4. The Control Interface screen will be displayed. Select the Product Control option desired for interfacing with the control system on the configured implement. For detailed information on the control option settings, refer to the *Product Control Options* section on page 94.

Note: *It is not possible to complete configuration of the OmniSeed control option until the activation key is entered on the field computer. Select the 'None' option to complete the initial configuration wizard. Refer to the *Special Features Registration* section on page 138 for a procedure to enter the activation key and then return to the Setup Wizard menu and restart the set up wizard to configure the OmniSeed Control Interface.*

5. Review the available system options at the bottom of the Control Interface screen. See the *Boom Master and System Options* section on page 97 for details.
6. Touch the Serial Port  icon in the upper, right corner of the screen to configure an optional serial device or light bar if desired. See the *Serial Port Configuration* section on page 98 for information on the available serial port settings.
7. Select the CAN Diagnostics  icon in the upper, right corner of the screen to check the status of the network and nodes currently detected and communicating with the field computer. Review the *CAN Diagnostics* section on page 30 for information on using the field computer to check status and readdress the CANbus.



8. Touch the Next  icon to proceed with the initial field computer setup.
9. Use the on-screen keypad to enter the implement, boom, or header width to the nearest inch [centimeter]. The value entered on this screen must be equal to the boom, implement, or header width which completes a field operation as the vehicle drives through the field. See the *Guidance Width* section on page 141 for more information on the Guidance Width value.
10. Once the Guidance width value is entered, select the Next  icon to proceed to the Implement Type screen.
11. Select one of the following options for an initial implement type to which the field computer will be connected during field operations.

Self Propelled or Mounted Implement. This option is best suited for fixed implements such as self-propelled sprayer, a harvester or combine, or an implement mounted to a tractor 3-point hitch. See the *Self Propelled or Mounted Implement* section on page 142 for details on configuring implements using this implement type.

Trailed Implement. Select this option to configure implements such as anhydrous tool bars, pull-type sprayers, planters, or air seeders with the air cart towed behind the seed drill. Refer to the *Trailed Implement Tractor Setup* section on page 144 for assistance with the trailed implement configuration.

Trailed Implement with Tow Between. This option has been designed for seeder implement configurations with the air cart towed between the tractor and seed drill. Refer to the *Trailed Implement with Tow Between Setup* section on page 146 for more information and assistance using the trailed implement with tow between option.

Additional implements may be configured at a later time for different towed implement or tractor configurations. Save Profiles for each configured tractor and implement configuration to simplify set up when moving the field computers between vehicles or the tractor is hitched to different implements. Refer to the *Profiles* section on page 152 for information on saving or loading vehicle profiles.

12. Touch the Next  icon to continue with the implement setup process. Refer to the specific implement setup process in the *Offsets and Implement Type Selection* section on page 142 for details on completing the implement configuration.
13. After the specific implement setup process is completed, touch the Next  icon to complete the initial calibration wizard and display the Setup Wizards Menu screen.

Setup Wizards

The setup wizards simplify the task of setting up the Envizio Pro control system for different products, implements or vehicles. Each setup wizard will display a series of prompts for which settings and calibration values will be required.

Setup Wizard Menu

After the initial setup is complete, a menu of the available setup wizards can be displayed by selecting the wizard icon in the upper left corner of the Tools menu.

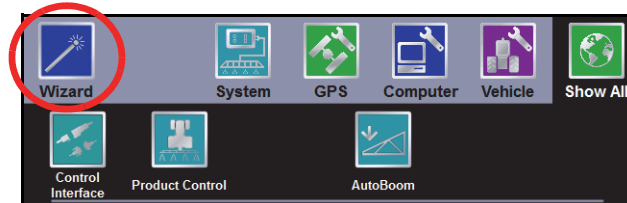

See Chapter 7, *Tools Menu*, for detailed descriptions of the other features accessible through the Tools menu.

The Setup Wizard Menu will display the available setup wizards which may be used to complete the initial setup of the field computer.

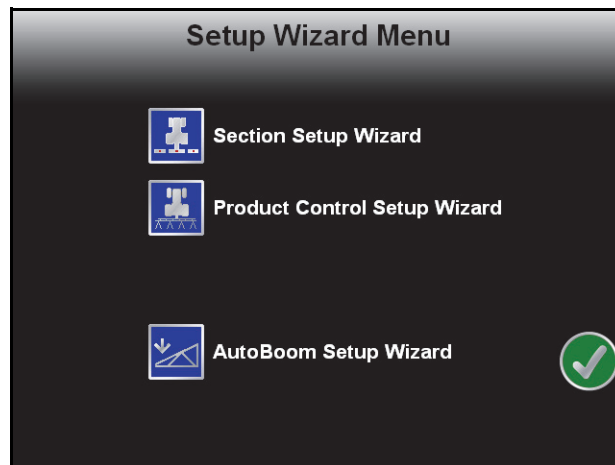

Note: Depending upon previous options selected during the initial setup wizard, completion of some wizards may be required before the field computer is ready for operation.

Only setup wizards which apply to the system will be displayed in the Setup Wizard Menu. For example, if a Glide Series AutoBoom system is not present on the CANbus, the AutoBoom setup wizard will not be displayed on this screen.

To launch a wizard, touch the icon next to the desired setup wizard to begin. Touch the Accept  icon to exit the Setup Wizard Menu.

Note: During the initial setup wizard, the Accept icon will be available only after all required wizards have been completed.

Refer to the following sections for detailed instructions on completing the setup wizards.

Product Section Setup Wizard

The product section setup wizard will guide the operator through configuring section widths and will require the following information:

- Number of sections
- Section widths
- Section configuration
- Desired section labels

Using the Product Section Setup Wizard

1. Touch the Product Section Setup Wizard icon. The Number of Sections screen will display.
2. Use the Up and Down arrow buttons to setup the number of sections for the vehicle or implement. Touch the **Next**  icon to proceed to the Section Width screen.

Note: To utilize automatic or individual section control, plumbing or section control hardware on the vehicle or implement must allow for individual section control. If the machine is not capable of controlling individual sections, set the number of sections to 1 and enter the overall boom or implement width on the Section Width screen.

3. Configure the width of each section starting with the far left section. Use the on-screen keypad to enter the section width.
4. Touch the Next  icon to accept the entered value and advance to the next section to the right.

Note: To skip a section, enter a value of zero as the section width.

5. Repeat step 3 and step 4 until the widths have been entered for all sections.
6. Touch the Next  icon on the last Section Width screen to advance to the Configure Sections screen.
7. If desired, touch the 'Configure Section Labels' button to customize section labels for the configured sections. Refer to the *Configuring Section Labels* section on page 150 for additional assistance with configuring section labels displayed by the field computer during field operations.
8. Select the Section Mapping option if desired to manually configure the section switch functions for customized functionality during field operations.

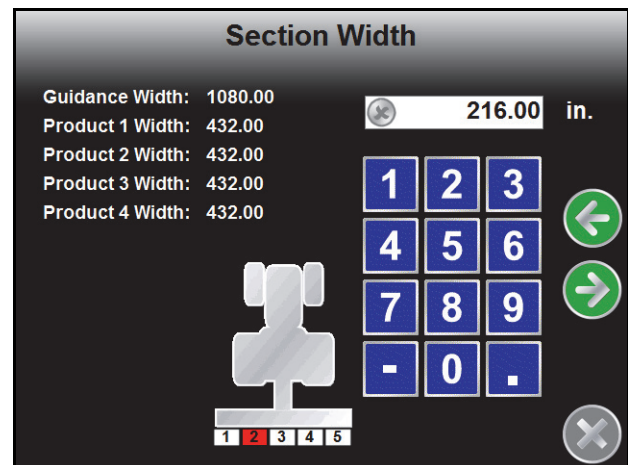

For Example: If using the switch box to control multiple products assigned to overlapping boom configurations (e.g. seeder implement with liquid sections), the section mapping feature allows the switch box to be configured so that the left most seed sections for 2 seed product sections are enabled or disabled using the same switch. Refer to Figure 2 on page 235 for a graphic of this example.

9. The field computer also allows the operator to set and adjust the location of configured sections. For standard configurations, such as a sprayer boom, a combine header or a single section implement, select the Auto Configure button to automatically align sections end-to-end along the swath midpoint.

Note: *Individual section locations may be manually modified after the operator has selected to automatically configure the section locations.*

For implement configurations where sections are staggered, overlapping or spread out, touch the Manually Configure button to manually adjust the fore/aft and left/right offsets for each individual section. Refer to *Manually Configure Sections* section on page 151.

Note: *The offset distances represent the offset from the DGPS antenna to the center of the selected section.*

10. Select the Auto or Manually Configure buttons and then touch the **Next**  icon to return to the Setup Wizard Menu screen.

Product Control Setup Wizard

The product control setup wizard will require the following information for each product connected to the field computer CANbus control system:

- Speed cal and sensor type
- Application type
- Valve cal and valve type
- Meter cal
- Rate cal
- Section assignments

Note: *By default, the product controller node is set to provide two control channels for the field computer. The initial configuration wizard will need to be completed before the number of control channels may be modified.*

Using the Product Control Setup Wizard

1. Touch the Product Control Setup Wizard icon to begin the setup wizard. The Speed Cal screen will display.
2. Use the radio buttons toward the left side of the screen to select the type of speed sensor which will be used with the control system.
3. Touch the button labeled 'Speed Cal' and use the on-screen keypad to enter the calibration value for the speed sensor installed on the vehicle. Refer to the *Speed* section on page 101 for more information about the speed cal value.

Raven Industries recommends the following speed calibration values for initial system setup.

| Sensor Type Setting | Used with | Recommended Initial Speed Cal | |
|---------------------|--------------------------------|-------------------------------|--------|
| | | English | Metric |
| Radar/GPS | External Raven GPS Receiver | 785 | 199 |
| | Internal DGPS Receiver | 812 | 206 |
| | GPS Speed over CANbus | 1000 | 1000 |
| | Raven Radar | 598 | 152 |
| Wheel | Wheel Magnets | 1000 | 254 |
| | Speedometer Drive Speed Sensor | 612 | 155 |

These values are good starting points and generally yield adequate results, however, the speed cal should be refined for each specific vehicle and speed sense system. See Appendix A, *Calculating the Calibration Values*, for instructions on refining the speed cal value.

Note: *The GPS speed over CANbus feature is only available with specific Raven speed sense nodes. This feature utilizes NMEA speed over ground data transmitted over the CAN network which eliminates the need for a separate, external speed sensor.*



NOTICE

When using the GPS speed over CANbus feature, no calibration or adjustment is necessary or recommended to the speed cal value. Losing GPS signal for more than a second will also result in loss of the CAN speed signal which may affect product application in progress.

The test speed and distance values are not required to complete initial setup of the field computer. Refer to the System Menu section on page 93 for detailed information about these settings.



4. Touch the Next  icon to continue the product control set up. The Application Type screen will display for the first product control channel.

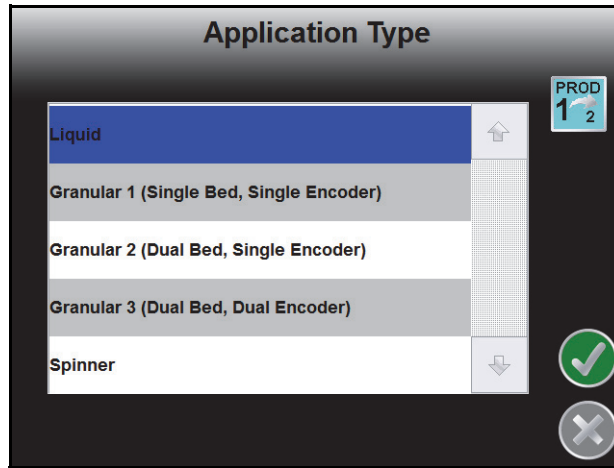

5. Use the scroll bar if necessary and select the type of application which the field computer will be interfacing with on control channel 1. See the *Application Type* section on page 100 for more information on the available application types.
6. Touch the Next  icon to proceed to the Valve Calibration screen.

Standard/Fast/Fast Close

PWM/PWM Close

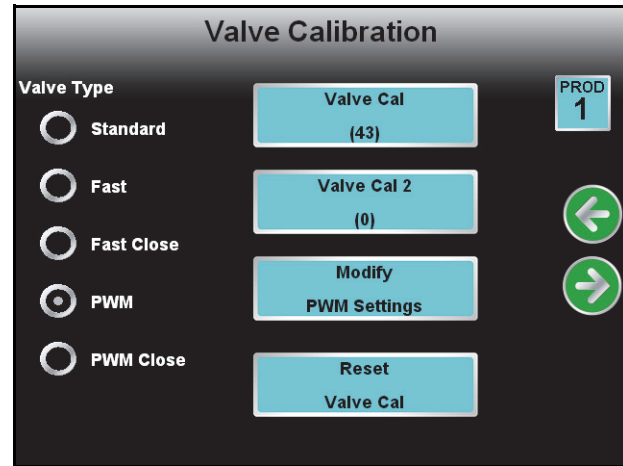
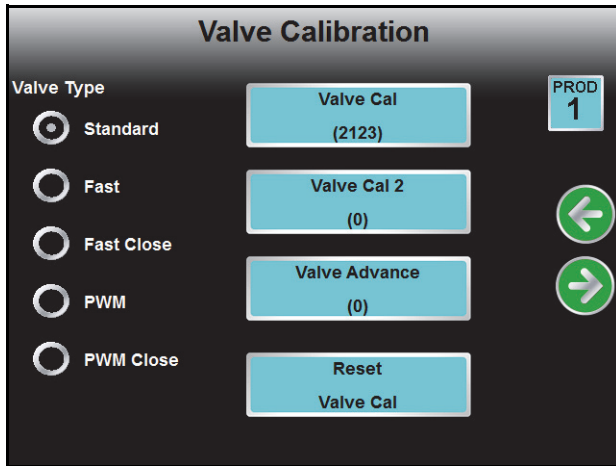

7. Select the type of control valve which will be used on the first control channel. Touch the 'Reset Valve Cal' button to let the field computer insert the recommended initial calibration value.

Raven Industries recommends the following valve calibration values for initial system setup.

| Control Valve Type | Valve Cal |
|---------------------|-----------|
| Standard | 2123 |
| Fast and Fast Close | 743 |
| PWM and PWM Close | 43 |

These values are good starting points and will generally yield adequate results, however, the valve cal

should be refined for the individual control valves installed on each specific machine. See Appendix A, *Calculating the Calibration Values*, for instructions on refining the valve cal value.

Note: The Valve Advance button is only available if the assigned product node has software version 1.50 or higher. Refer to the Valve Advance (Standard or Fast Valve) section on page 105 for information about the Valve Advance feature.

The Modify PWM Settings button will only be displayed if PWM or PWM Close is selected as the valve type. Refer to the Modify PWM Settings (PWM or PWM Close Valve) section on page 106 for information on these settings.

8. Touch the Next  icon. The field computer will display a prompt for one of the following:

- Meter cal for the flow meter used to measure the first control channel 1 (liquid products). The flow meter calibration number can be found on the tag attached to the flow meter. Refer to the *Meter Cal* section on page 191 for details on adjusting the meter cal.

Note: Copy the information from the tag for future reference as the tags may fade or be lost during operation.

- Density of product 1 (granular products). Refer to *Product Density* section on page 200 for details on the product density required for the control system.
- Spinner cal (spinner control nodes). Refer to the *Spinner RPM* section on page 201 for information on calculating the spinner cal value necessary for spinner control.

Use the on-screen keypad to enter the correct value.

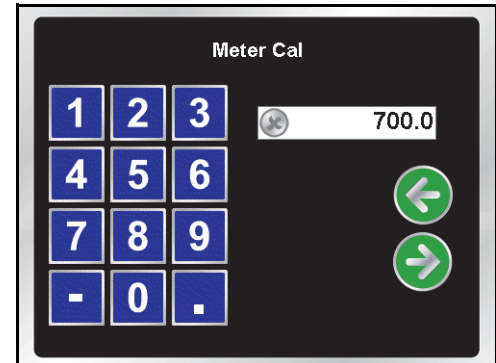

9. Touch the Next  icon. The field computer will display a prompt for one of the following:

- Rate cal (liquid and granular products). Review Appendix A, *Calculating the Calibration Values*, for information on calculating the rate calibration value for a specific application type.
- RPM cal (spinner control nodes). Refer to the *Spinner RPM* section on page 201 for information on the necessary RPM cal to control spinner speed during field operations.

Use the on-screen keypad to enter the target rate or spinner RPM for product 1.

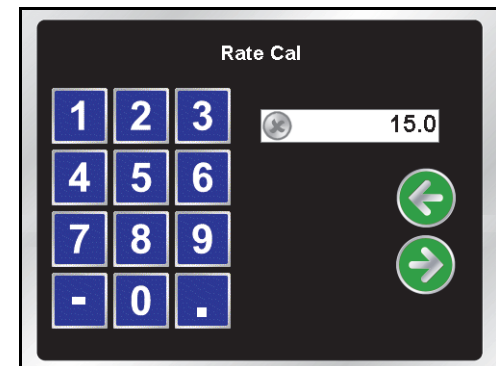

10. If a granular application control type is selected, the field computer will prompt the operator for the Spreader Constant. Refer to the *Spreader Constant* section on page 199 for details on calculating and adjusting the spreader constant value for the specific application equipment.

11. Touch the Next  icon. The Section Assignments screen for the first control channel will be displayed.

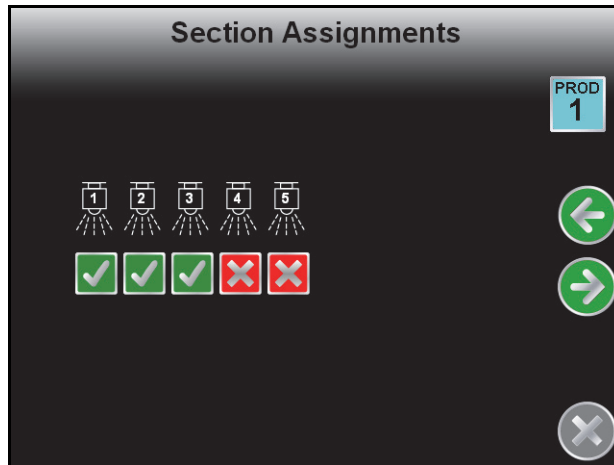

Select the desired sections for the first product application. To turn product application off from sections, touch the check corresponding to sections until a red x displays.

12. Touch the Next  icon to complete the Product Control Setup Wizard for the first control channel.

If only one product control channel is available in the CANbus control system, the display will return to the Setup Wizard Menu.

If additional product control channels are available, the field computer will automatically restart the Product Control Setup Wizard for each channel in sequence. Repeat step 4 through step 12 to configure remaining control channels and complete the Product Control Setup Wizard.

13. After the last control channel configuration is complete, touch the Accept  icon to proceed to the Home screen.

Note: *During initial setup of the field computer, the Accept icon will only be displayed on the Setup Wizard Menu once all required wizards have been completed.*

AutoBoom[®] Setup Wizard

If an optional Glide Series AutoBoom system has been installed, the AutoBoom setup wizard is available to calibrate and verify system settings during the initial setup.

The AutoBoom setup wizard may require the following information:

- Pressure Set (PowerGlide Plus)
- Sensor Height and Sensor Height Offsets (UltraGlide)
- PWM Frequency and Minimum Pressure Percent
- Speed
- Sensitivity
- Stability Factor

Using the AutoBoom[®] Setup Wizard

Refer to the *CAN AutoBoom Calibration & Operation Manual* for more information regarding setup and use of the Glide Series AutoBoom system.



CHAPTER

6

Basic Operation

Overview

This chapter contains information regarding the basic operation of the Envizio Pro field computer in a CANbus control system, including:

- Home screen
- Shutting down
- Starting jobs
- Guidance patterns
- Using the guidance screen

Home Screen

After the initial startup, the field computer will automatically startup to the Home screen.



The Home screen offers access to the following features of the Envizio Pro field computer:



**Start or
Resume Job**



**Access the
Tools Menu**



Shutdown

Note: *The Envizio Pro should be properly shutdown before turning the power off on the field computer.*

GPS Status

The current source and status of DGPS signal is displayed in the upper, left corner of the Home screen.



Note: The standard GPS shield will be displayed if the Envizio Pro field computer cannot determine the type of corrections being sent from the DGPS receiver.

The status icon on the Home screen will display:

- Green if the status of GPS is okay.
- Yellow if an error or cautionary condition has been encountered.
- Red if GPS is non-functional. Make sure the DGPS antenna cable connections are secure and the antenna has a clear, 360° view of the sky.

Note: Refer to the *GPS Menu* section on page 120 for additional information on settings or features available for the above correction sources.

RTK Fixed and Float Modes

When using an RTK correction source with the internal dual frequency GPS receiver, the GPS status indicator may be used to determine whether the receiver is operating in RTK fixed or float modes. The RTK shield will display:

- Green to indicate a fixed RTK position. This mode indicates that the receiver has a full RTK position fix and is providing sub-inch corrections. The GPS Health screen will display a value of 4 for the differential mode when operating in RTK fixed mode.
- Yellow to indicate that the receiver is operating in RTK float mode. This mode indicates that the receiver is not able to provide a full RTK position lock due to the distance from the base station, visibility of the sky, time of day or interference around the base station location. In the float mode, the receiver is still providing a coarse RTK correction signal, but accuracy of the receiver may not be at a sub-inch level. The GPS Health screen will display a value of 5 for the differential mode when operating in RTK float mode.

Touch the shield icon to display the GPS Status screen. Refer to the *GPS Menu* section on page 120 for more information on the GPS Status screen.

Wireless Communications Status

The current status of wireless communication is displayed along the top of the Home screen display. This icon will appear:



- Gray if no wireless communications device is connected to the field computer.
- Green if communication is okay.
- Yellow if an error condition has been encountered.
- Red if wireless communication is not available.

Touch the shield icon to display the Wireless Status screen. Refer to the Appendix C, *Wireless Communications & Remote Service* for more information.

Information

Touch the information icon in the upper, right corner of the home screen to display the software and image versions currently installed on the field computer.



Closing Jobs and Power Down

Be sure to close any open job files before turning the field computer power off. The Envizio Pro should be powered down using the Shutdown icon on the Home screen.

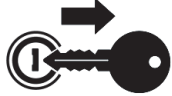

NOTICE

Failure to properly close a job before turning off the field computer may result in a loss of application data or other information for that job. Make sure to properly close any open jobs before shutting down the computer.



To end jobs on the Envizio Pro:

1. Open the menu on the Guidance screen and touch the green home icon to return to the Home screen.

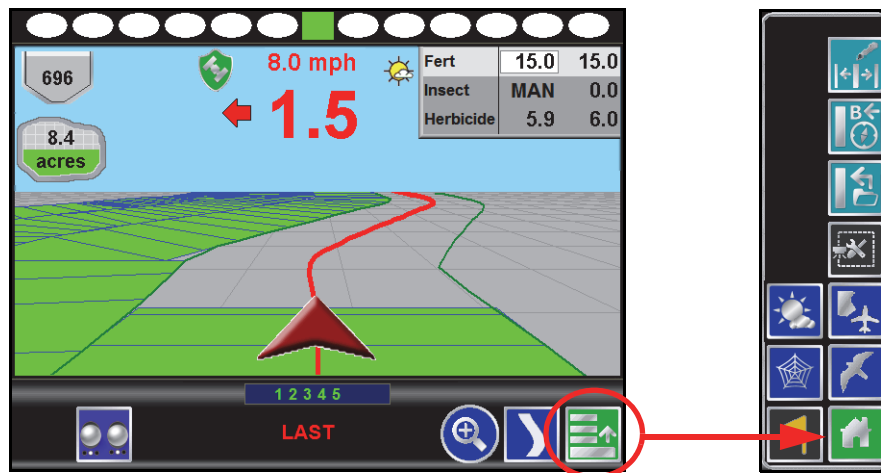

2. The Home screen will be displayed. The Home screen displays 'Job in progress' during an active job and the Shutdown icon is replaced by the Stop icon.



3. Touch the Stop icon to close the currently active job.

Note: Touching the Start icon with a job in progress will return to the Guidance screen of the active job. To begin a new job, first touch the Stop icon to close the job in progress before selecting the Start icon.

4. Confirm closing the open job file by touching the green check mark. To keep the current job open, touch the red 'x.' Closed jobs can be re-opened later by selecting an existing job file during the Start Job procedure. See the *Setting up a Job* section on page 56 for more information.
5. The Stop icon will be replaced with the Shutdown icon. Touch the Shutdown icon to power down the field computer.

Job Files

Overview

The Envizio Pro stores field and product information in job files. In general, job files are created for each field and contain the following information:

- Target rate (min and max)
- Coverage area and area within a field boundary
- Volume of product applied
- Prescription map information (if applicable)

These files are automatically created for each job started on the Envizio Pro.

Note: *To ensure field computer memory resources are available, Raven recommends performing file maintenance periodically to remove unused job files from the memory on the console. Refer to Chapter 8, Software Updates and File Maintenance for more information.*

A job file allows the operator to:

- Create and save new field boundary and coverage maps and other information for each application without erasing or modifying previous jobs stored on the field computer.
- Load previously created job files and coverage maps to resume a job at a later date. Saved field boundaries, zone maps, guidance paths or other information stored on the field computer for the job may be recalled to continue the application right where the operator left off.
- Save and load job files at any time during a field application. This allows the field computer to work in multiple fields or on different applications without losing application information for any other existing or unfinished job file.

Starting a Job

Before starting field guidance and creating a job file, the Envizio Pro field computers require the operator to check and verify job information. During this process, the operator may choose to create a new job or to resume an existing job as well as enable features and options to be used during the field operation.

Note: *If the field computer will be controlling products via a Raven CAN system, make sure all nodes connected to the CANbus are recognized and programmed correctly. Refer to Chapter 4, CAN Networking and Diagnostics if nodes do not appear to be recognized by the field computer.*

During the job setup process, the field computer may require the following information:

- Type and name of the job to be created
- Optional automatic section control systems such as AccuBoom or AccuRow
- Product control and rate information
- Optional AutoBoom system

Setting up a Job

This section contains detailed instructions for setting up a job. Depending upon the application and other features of the product control system, some of the following steps may not be required to begin all jobs.

1. Touch the Start icon on the Home screen. The Start Job - Verify Settings screen will be displayed.

| Start Job - Verify Settings | |
|-----------------------------|---|
| Job | Type: New Name: JOB-20120410-1325 |
| AccuControl | AccuBoom: Enabled AccuRow: |
| Prod1 | Status: Automatic Name: Prod1 Rt=20.00 |
| Prod2 | Status: Manual Name: Prod2 Rt=5.00 |
| Prod3 | Status: Off Name: |
| Prod4 | Status: Product Disabled Name: |

Note: *Settings and features displayed on this screen may not be accessible while a job is in progress. Verify that all settings are correct and all nodes connected to the CANbus are detected by the control system before beginning the job. If the status of any nodes connected to the CANbus display 'Node Offline,' refer to Chapter 4, CAN Networking and Diagnostics, before starting the job.*

2. Touch the Job button and refer to the *Job File Setup* section on page 58 to name a new job file or resume an existing job saved on the field computer.
3. Touch the AccuControl button to enable or disable an available automatic section control feature (i.e. AccuBoom or AccuRow) or select a zone map. Refer to *AccuControl Setup* section on page 59 for details on configuring the AccuBoom feature. Review the AccuRow or OmniRow Calibration and Operation Manual for more information on the section control feature on planter control systems.
4. Select the Product buttons to configure product nodes or control channels to control product application during the active job. See the *Product Setup* section on page 59 for more information on setting up the nodes or control channels.

- Touch the Accept  icon in the lower, right corner of the screen to begin the job. See the *Guidance Screen* section on page 62 for more information. Touch the Cancel icon to end job setup without starting the job.

Note: *Canceling the job will discard any settings or selections made on the setup screens. Any configured settings or selections will be lost.*

- If an optional AutoBoom system is detected on the CANbus, the AutoBoom Setup screen will be displayed. Refer to the *AutoBoom® Setup* section on page 61 to enable or disable the AutoBoom feature.

Direction of Travel

The last direction of travel detected by the field computer is displayed on the Start Job - Verify Settings screen.

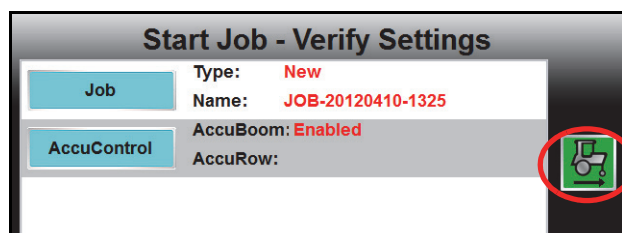

If the direction of travel indicator displays incorrectly, touch the indicator to manually toggle the last detected GPS direction.

Note: *The direction of travel indicator is also displayed on the GPS Health screen and may be toggled during a job if necessary.*

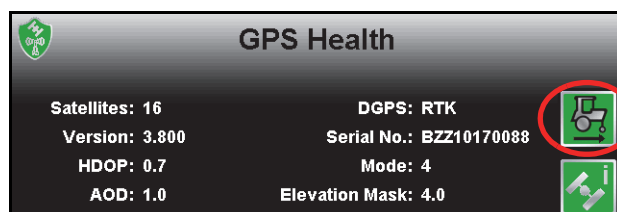

Refer to the *Reverse Sensing* section on page 121 for more information or to enable the direction of travel indicator. The direction of travel indicator will not be displayed if a SmarTrax 3D node is detected on the CANbus and the terrain compensation feature is active.

Job File Setup

Select the Job button to select an existing job file or rename the new job.

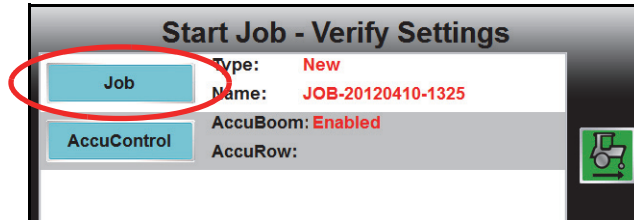

Note: *Renaming new job files is highly recommended if a specific job will be referenced at a later date. The operator should enter field location, product or any other information which may help identify specific job files. Names of job files entered on the field computer cannot begin or end with a space.*

The Select Job screen will display.

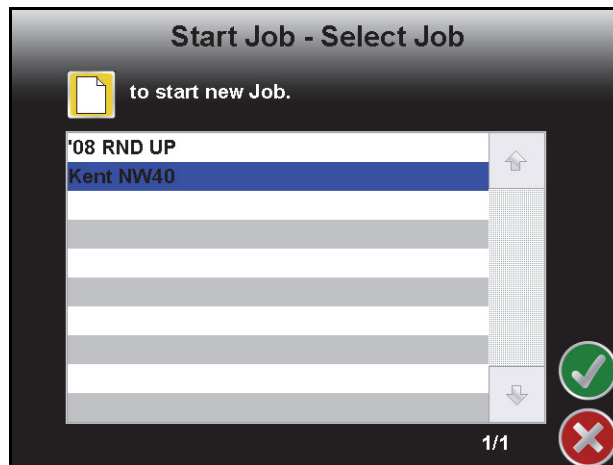

To Resume an Existing Job: Select the existing job file from the list and touch the Accept icon to return to the Verify Settings screen. When the Guidance screen is displayed, coverage maps from the existing job will be displayed on the Guidance screen.

To Start a New Job: On the Select Job screen, touch the Create New icon. The New Job: Enter Name screen is displayed. Use the on-screen keypad to enter the name of the new job file. Touch the Accept icon to confirm the entered name and return to the Start Job - Verify Settings screen. Touch the Cancel icon to return to the Start Job - Verify Settings screen without accepting the job name.



Note: *Job names stored on the field computer cannot begin or end with a space.*

AccuControl Setup

If an optional section control feature is available, touch the AccuControl button to create a new zone map or load a previously created plant zone map for the job.

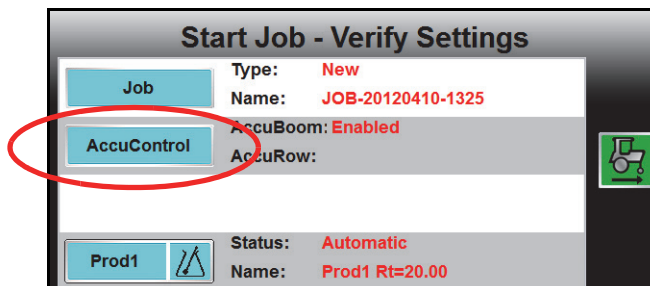

Note: Refer to Chapter 9, *Using AccuBoom™*, for more information about using AccuBoom. For details on using the AccuRow feature, refer to the *AccuRow or OmniRow Calibration and Operation manual*.

The status for optional section control features may be displayed as follows:

- Disabled - Feature is available or CANbus node is communicating, but optional features are not enabled for this system.
- Enabled - Feature is available or CANbus node is communicating and optional system features are enabled.
- Node Not Detected - The CANbus node is currently not detected by the field computer.

If selected, the name of the selected zone map will be displayed in the zones field.

Product Setup

To setup product nodes or control channels, select the corresponding Product button to setup the product control for the selected node.

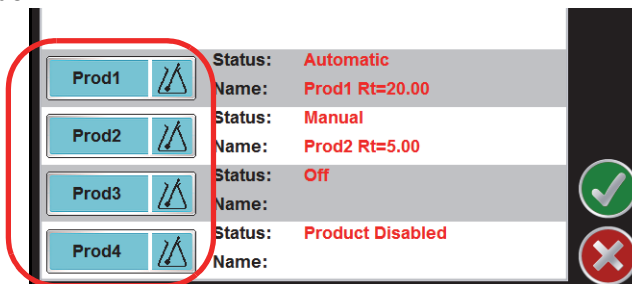

Note: If the optional multi-product activation key is entered, up to four product nodes or control channels may be displayed on the Verify Settings screen.

The selected Product Setup screen will be displayed.

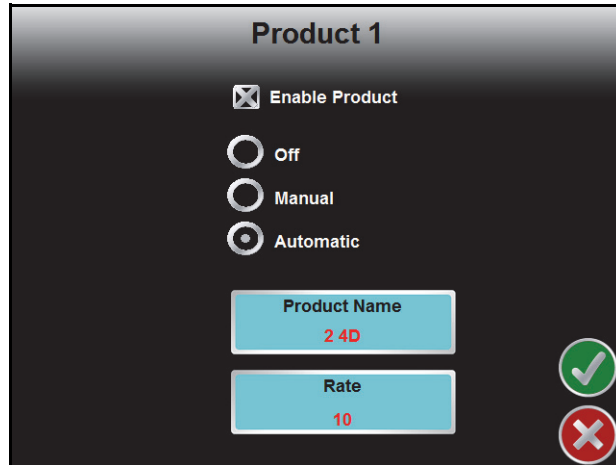

Enable Product. Select the “Enable Product” option to enable control for the selected product. If the product is not enabled during job setup, the job must be closed and a new job file started to allow the node or channel to control product application.

Rate Control Mode. Choose the preferred rate control mode for the product. Select between Off, Manual or Automatic.

Note: *If a CAN Switch Box is installed with the field computer, the rate control mode must be set using the product control switches on the switch box. The field computer will display the selected mode for each product.*

Product Name. The currently selected product name is displayed on the Product Name button. Touch the Product Name button to display the Start Job - Select Product screen.

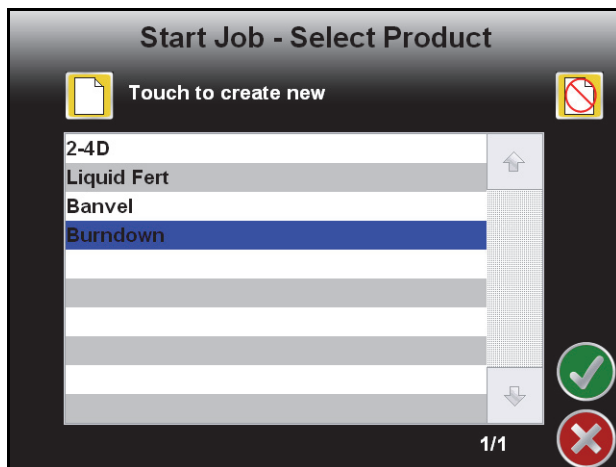

Select a product name from the displayed list or create a new name by touching the Create New icon. Use the displayed keypad to enter the name of the new product.



Note: *Product names entered on the field computer cannot begin or end with a space.*

Touch the Delete Product icon to remove a product name from the list.



Target Rate. The currently entered target rate is displayed on the Rate button. Touch the Rate button and use the displayed keypad to set a new target rate.

Prescription (Rx) Setup

Touch the prescription icon to assign a prescription map to the selected control channel.

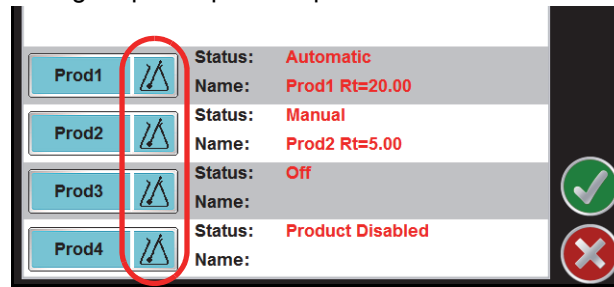

Refer to the *File Maintenance* section on page 154 for assistance with transferring maps onto the Envizio Pro.

AutoBoom[®] Setup

If an optional AutoBoom system is detected on the CANbus, the field computer will display the AutoBoom setup screen before accessing the Guidance display and features. Review the *AutoBoom Calibration and Operation Manual* for detailed operation of this feature with the Envizio Pro field computers.

Guidance Screen

During a field operation, or job, on the Envizio Pro field computers, the Guidance screen provides the application or coverage information and will likely be the most viewed screen during a job. Using DGPS coordinates, the field computer offers several field guidance tools to help reduce operator fatigue and minimize skips and overlaps during product application.

Guidance Features

The following features are available during a job on the Envizio Pro field computer:

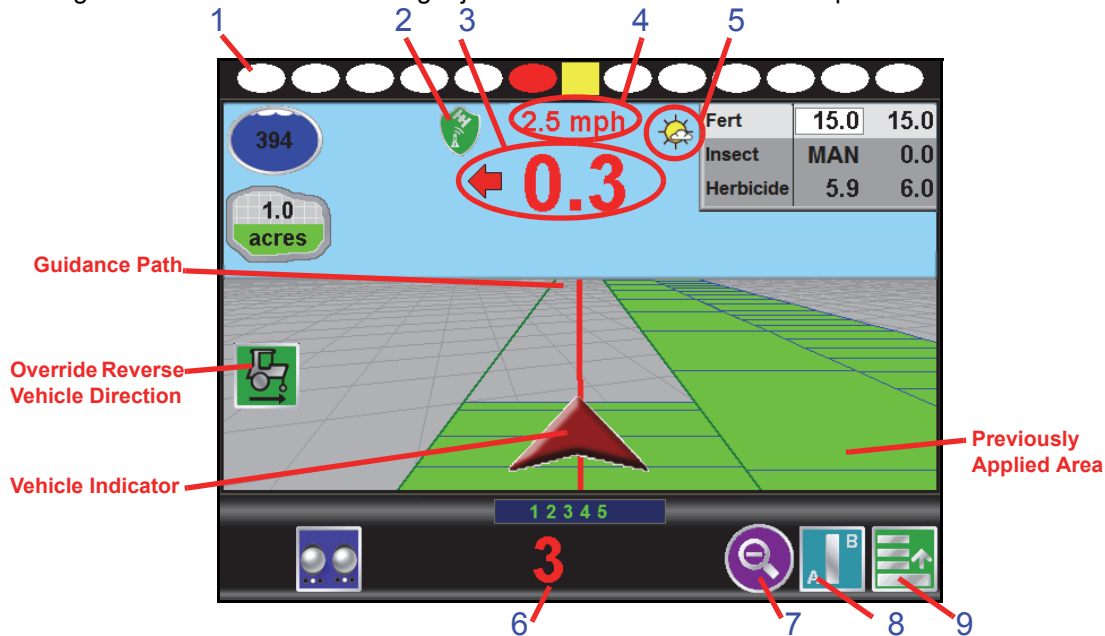

Note: With the reverse sensing feature enabled, it may be necessary to manually override the course of the vehicle indicator. The direction of travel icon (shown to the right) will be displayed on the Guidance screen any time the field computer detects that the vehicle is traveling in reverse. Touch the reverse direction icon to manually toggle the direction of travel displayed on the Guidance screen.



If the reverse direction icon is not displayed on the Guidance screen, touch the GPS Status Indicator and touch the direction of travel icon along the right side of the screen to manually toggle the displayed vehicle course.

1. On-Screen Light Bar - The on-screen light bar illuminates to represent the vehicle's location with respect to the displayed guidance path.
The center square displays green when the vehicle is "on line." As the vehicle moves away from the line, the center square will turn yellow and the surrounding ovals will begin illuminating to represent distance from the guidance path. See the System menu section in Chapter 7, *Tools Menu*, to setup the light bar display.
2. GPS Status Indicator - Displays the current GPS correction source and signal status. Review the *GPS Status* section on page 52 for details.
3. Distance from Path - This display shows the distance and the direction to the guidance path. The value displayed is in feet (English) or meters (Metric) and the arrow points in the direction to the displayed guidance path.

4. Speed or COG Display - Vehicle speed or Course Over Ground is displayed in this area. Touch this area to toggle between the Speed or COG display.
5. Day/Night Mode - Touch this icon to toggle the Guidance display for day or night operations.
6. Swath Number - During straight line, pivot and fixed contour guidance patterns, the number of the current swath is displayed in this area. When in Last Pass mode, this area displays LAST.
7. Zoom - Touch the Zoom icon to cycle through the zoom levels on the displayed guidance screen. Pressing the zoom icon at the maximum zoom level (Level 5) will return to the minimum zoom. Continue pressing the zoom icon to cycle through the zoom levels as desired.
8. Guidance Pattern - Touch the icon displayed in this area to toggle between the available guidance patterns. See the *Using Guidance Patterns* section on page 63 for more information on using specific patterns.
9. Menu - Guidance screen views, path tools and options, and AccuBoom mapping features are all accessible through the Menu. See the Menu section later in this chapter for more information on using tools and features found within the Menu.

SmarTrax™ Status Display

If the optional SmarTrax system has been installed, the status of the system will appear on the Guidance screen.

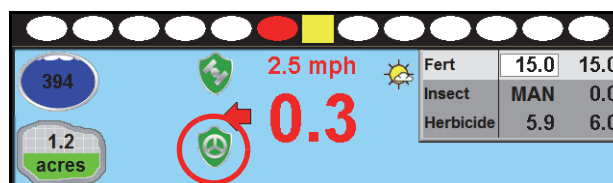

Using Guidance Patterns

The following Guidance Patterns are available on the Envizio Pro:

- Enhanced Last Pass
- Straight (A-B) Line
- Fixed Contour
- Pivot

Refer to the following descriptions for more information on the available Guidance Patterns as well as using selected patterns during a job.

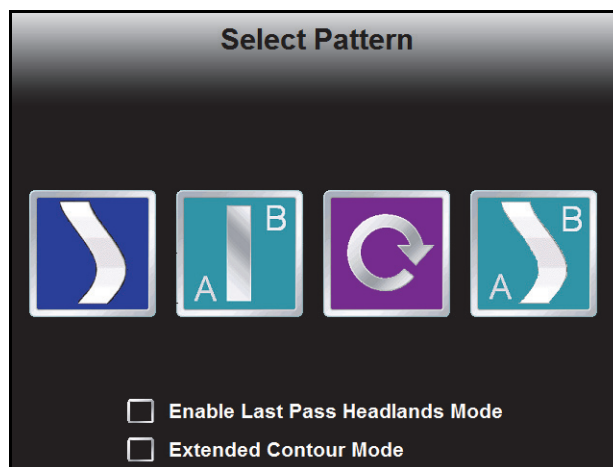

Enhanced Last Pass

The Last Pass pattern uses the last, or nearest, applied or covered area and the guidance width to create the following guidance path.

While this pattern does not require the operator to set 'A' or 'B' points, a previously applied or covered area must be present in the active job before this pattern will display the next guidance path. The Last Pass must follow the previous applied area and will not project subsequent paths beyond the next guidance path.

The Last Pass guidance pattern has been enhanced to provide accurate steering along the displayed guidance path with systems such as the Raven SmarTrax assisted steering systems. Contact a local Raven dealer for more information about Raven assisted steering systems available for use with the Envizio Pro field computer.

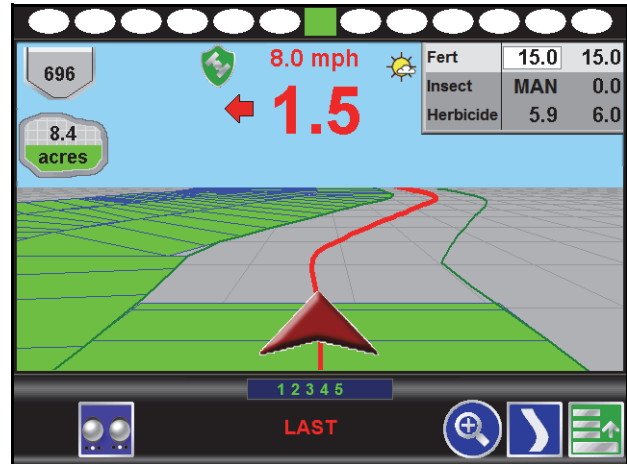

The Enhanced Last Pass is well suited to provide guidance for irregular swaths due to irregular field boundaries, well heads, or waterways, etc.

Note: *The Last Pass guidance pattern is designed to function in areas with a single, well defined, continuous coverage or as-applied map. If the coverage map displays multiple coverage areas or breaks in coverage, one of the other guidance patterns may provide better results and is recommended.*

Headlands Mode. If the Last Pass pattern attempts to lock onto headlands swaths incorrectly, be sure to select the 'Enable Last Pass Headlands Mode' option on the Select Pattern screen while setting up the job. This will allow the field computer to ignore the headlands passes when working the field in alternating 180° swaths.

If the Last Pass guidance pattern will be used to cover the field in a rectangular pattern (outside to inside) leave the 'Enable Last Pass Headlands Mode' option disabled (empty).

Straight (A-B) Line

The Straight Line, or parallel, guidance pattern is created by drawing a straight line through two user defined points (points A and B). After setting the A and B points, the field computer can use the programmed guidance width and the original path to project parallel guidance paths for the rest of the coverage area.

As long as the Straight (A-B) Line pattern is active and the original path is available, the field computer will display the nearest path regardless of previous application history or coverage mapping.

See the *A-B Path Tools* section on page 73 for help using the A-B guidance line tools and features with the Straight Line pattern.

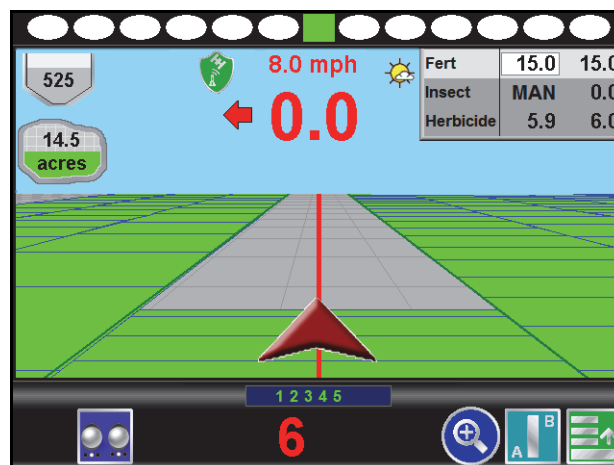

The Straight (A-B) Line pattern is well suited for applications within rectangular fields and row crops.

Fixed Contour

The Fixed Contour guidance pattern allows the operator to record and save an irregular swath pattern and to use the same tools available for other A-B paths. Similar to the Straight Line pattern, the operator sets the first, or A, point of the swath and begins driving the swath. The field computer records points along the driven path until the operator sets the B point. The field computer then connects the recorded points and displays the Fixed Contour path. After the A and B points are set, the field computer is able to use the programmed guidance width and the original path to project additional contour paths for the rest of the coverage area.

As long as the Fixed Contour pattern is active and the original path is available, the field computer will display the nearest path regardless of previous application history or coverage mapping. See the *A-B Path Tools* section on page 73 for help using the A-B guidance line tools and features with the Fixed Contour pattern.

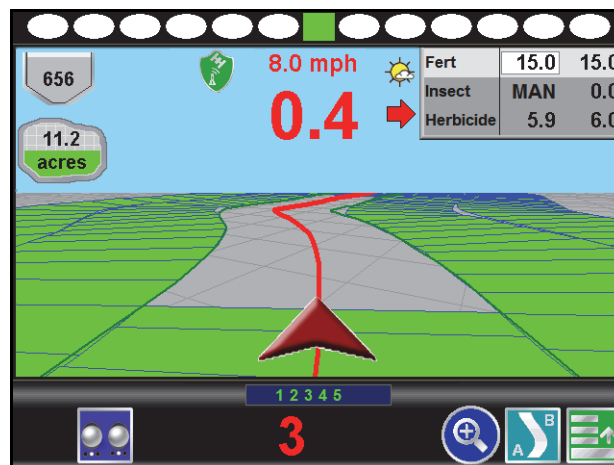

The Fixed Contour pattern is ideal for creating and saving swaths which follow irregular field boundaries, waterways, well heads, etc., or where the ability to skip swaths in an irregular pattern is necessary.

Note: *Curvature of the Fixed Contour guidance path should not be too aggressive. Overly aggressive curves may produce undesirable results.*

Always be aware of sharp turns when using the Fixed Contour pattern if an assisted steering system such as Raven SmarTrax system is engaged. Contact a local Raven dealer for more information about Raven assisted steering systems available for use with the Envizio Pro field computer.



Pivot

The pivot pattern is designed to provide guidance within row crops with a center pivot, or circle, irrigation system. To begin guidance using the pivot pattern, the operator must set two points along the circumference of the field or the swath furthest from the irrigation hub.

Set the first, or 'A,' point at the start of the swath furthest from the irrigation hub and drive along the field circumference and set the second, or 'B,' point at the end of the swath. Using these two operator defined points and the vehicle guidance width, the field computer calculates circular paths stepping toward the center of the field area.

As long as the Pivot pattern is active and the original path is available, the field computer will display the nearest circular path regardless of previous application history or coverage mapping. Currently, this pattern does not require that the entire circumference of the field is driven before beginning guidance; however, better results are achieved by driving further along the guidance line.

See the *A-B Path Tools* section on page 73 for additional assistance when using the A-B guidance line tools and features with the Pivot pattern.

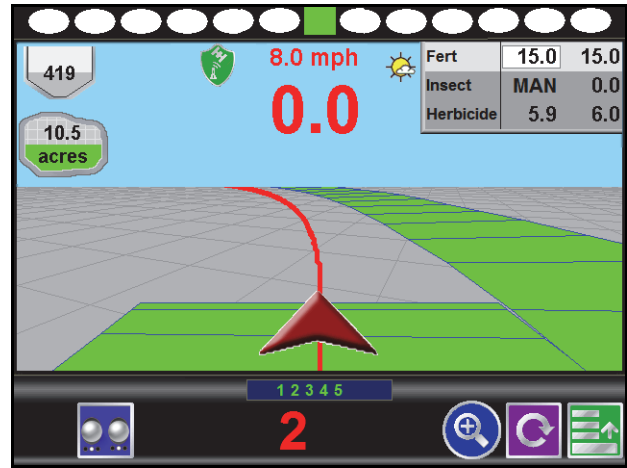

Product Control Features

In addition to guidance features of the Envizio Pro, the Guidance screen displays product control information, coverage maps, as well as vehicle and GPS information.

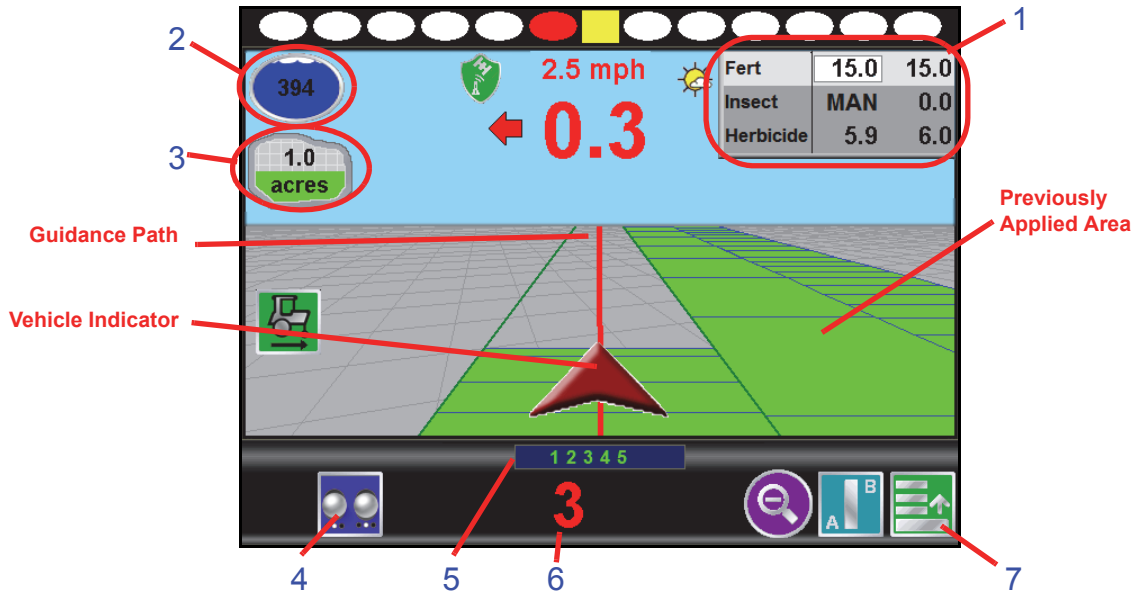

1. Product Rate Display - This area displays the target and actual rates for each product enabled for the current job. Touch the names area of the product rate display to toggle the selected product.

The Guidance screen displays area covered and volume indicators corresponding to the selected product. Touch the target and actual rates area to access additional features and configuration settings while in a job. See the *Product Rate Display* section on page 68 for more information on using this display.

2. Tank or Bin Indicator - Displays the volume of product remaining in the tank or bin. Touch this area to display the Volume Configuration screen. See the *Tank or Bin Indicator* section on page 67 for more information.
3. Area Covered - This indicator displays the area covered during the current job.
4. On-Screen Switch Box - If an optional automatic section control feature is enabled for the current job, the on-screen switch box icon will be displayed in this location. Touch this icon to access the section control feature screen to control individual sections or activate the feature override. Refer to the *On-Screen Switch Box* section on page 171 for more information on using the on-screen switch box to configure section control modes or the AccuBoom override feature.
5. Section Status - The label for each section configured on the field computer appears in this area. Active sections appear green while sections currently disabled (or toggled off) appear in white.

Note: With the optional AccuBoom feature installed, section labels displayed in amber signify that AccuBoom control of the section is enabled, but AccuBoom has toggled the section off.

6. Swath Number - During straight line, pivot and fixed contour guidance patterns, the number of the current swath is displayed in this area. When in Last Pass mode, this area displays LAST.
7. Menu - Guidance screen views, path tools and options, and AccuBoom mapping features are all accessible through the Menu. See the *Menu* section on page 72 for more information on using tools and features found within the Menu.

Tank or Bin Indicator

The tank or bin level indicator displays an estimate of product remaining in the tank or bin for the selected product.

Touch this indicator to view the Tank or Bin Volume Configuration screen. The Volume Configuration screen will display the current level remaining in the tank or bin.

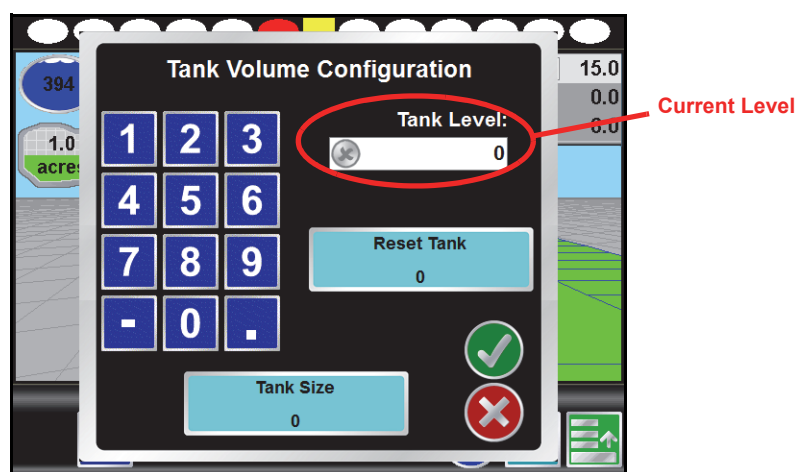
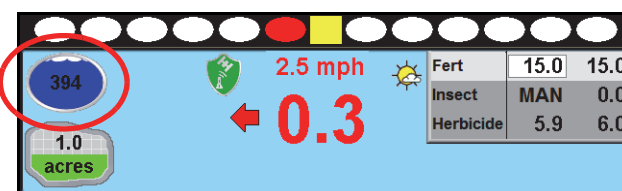

To adjust the tank or bin level for the selected product:

1. Use the keypad to enter the volume of product remaining.
2. Touch the Accept icon to enter the new tank or bin level and return to the Guidance screen. The tank or bin level indicator will display the entered level.

Note: Touch the Cancel icon to exit the Volume Configuration screen without keeping any changes made on this screen.



Reset Tank or Bin Button. Touch the Reset button to quickly reset the tank or bin level to the pre-programmed bin or tank size.

Tank or Bin Size Button. Touch the tank or bin size button to configure the volume of product in the tank or bin. Each product control node may have a separate volume and tank or bin level.

Note: *If the Reset button will be used to recalibrate the bin or tank level, the bin or tank size should be set at the volume of product in the tank after refilling; not necessarily the capacity of the bin or tank.*

Tank Fill. If an optional tank fill system is installed and detected by the Envizio Pro, the field computer will display the fill system interface. Refer to Appendix G, *Tank Fill Monitor Calibration*, for assistance with using the tank fill system.

Ultrasonic Bin Level Sensor. If an ultrasonic bin level sensor is installed, the volume reading does not need to be reset when refilling bins. Refer to the *Tank Volume or Bin Level* section on page 113 for details on calibrating the ultrasonic bin level sensor when the product bins are empty.

Product Rate Display

The field computer displays rate information for each enabled product in the upper, right corner of the Guidance screen.

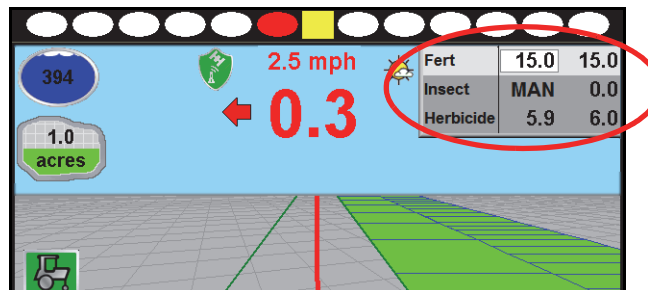

The following information appears in the Product Rate Display:

- Name of each enabled product
- Target rate of each product
- Actual rate of each product
- Selected product

Note: *While monitoring product application from a separate rate control console via a serial connection, the field computer will display the number of products currently enabled on the rate controller.*

Selected Product. During a single product application, the product enabled during the job setup process will always be selected during the job.

If additional products are enabled, the name and rates of the selected product are highlighted. To toggle the currently selected product, touch the product names within the Product Rate Display. Tank or bin volumes, area applied and coverage maps are displayed according to the product selected in the Product Rate Display.

In Job Product Configuration

Several product control settings and display options are available during a job by touching the rates area of the Product Rate Display. The following screen is displayed:

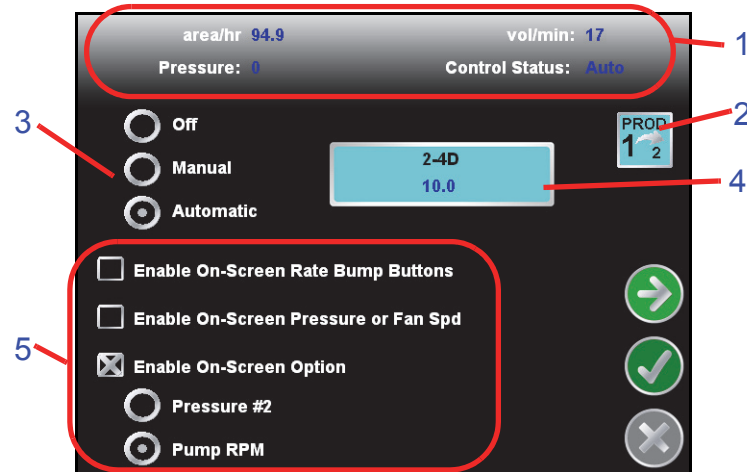

The following information is displayed on this screen:

1. Application information
2. Selected product
3. Control mode
4. Target rate
5. Display options

Touch the green check mark to return to the Guidance screen.

To view and setup additional settings for each product, touch the green arrow to display the Product Control Configuration screen. Refer to the *Product Control* section on page 99 for more information on product control configuration.

Application Information. The Application Information displays the following information for the selected product:

- Area per hour
- Pressure or fan speed - if an optional pressure transducer (P/N 422-0000-059) or fan speed sensor (P/N 063-0171-277) has been installed
- Volume per minute
- Control status
- If a PWM or PWM Close valve is setup to control the selected product, the duty cycle of the PWM valve appears in this area

Selected Product. The selected product icon displays the current node or control channel for which the in job product settings are displayed. If multiple products are enabled during the job setup, the selected product icon may also be used to cycle through enabled nodes or control channels to configure other nodes or control channels without returning to the Guidance screen.



Product 1 Only Product 2 Only

If only one product is enabled for the current job, the selected product icon will display similar to icons shown to the left. The displayed product node or control channel is always selected during the active job.



Cycle to Product 2 Cycle to Product 1

If additional products are enabled for the current job, the selected product allows the operator to cycle through the enabled nodes or control channels. Before modifying any settings displayed on the screen, check that the correct product node or control channel is selected.

Control Mode. Use the control mode to set the mode of operation for the product control valve. Select:

- Off to turn off product control for the selected product.
- Manual to control the actual application rate manually.
- Automatic to allow the field computer to control product application rates automatically.

Note: *If a CAN Switch Box is installed with the field computer, the field computer will display the control mode set using the Product Control switches on the switch box. Refer to the CAN Switch Box Installation and Operation Guide for additional operation of the CAN Switch Box.*

Target Rate. The name and target rate of the selected product are displayed on a button on the In Job Product Configuration screen. Touch this button and use the displayed keypad to adjust the target rate.

Display Options. Additional displays may be enabled or disabled with the options at the lower portion of the screen.

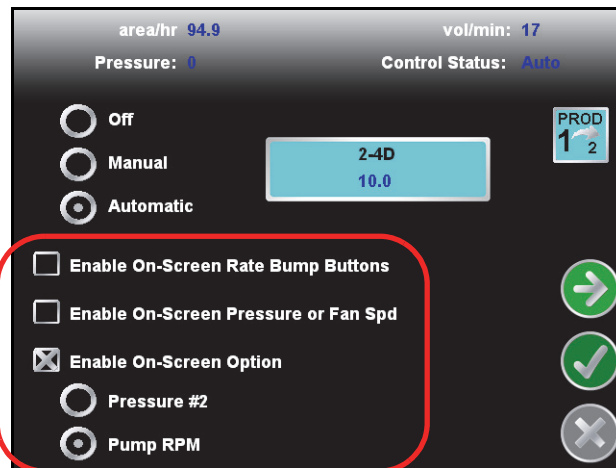

The following screen features are available on this screen:

- On-Screen Rate Bump buttons - While in CAN product control mode, Rate Bump buttons may be used to increase or decrease the application rate of the selected product by a user defined rate “bump” value. Select the ‘Enable On-Screen Rate Bump Buttons’ option to show these buttons on the Guidance screen.

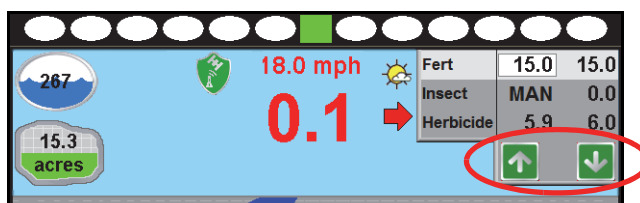

When the product is in automatic mode, the Rate Bump buttons will increase or decrease the target rates for the selected product. When in Manual mode, the Rate Bump buttons increase or decrease the actual application rate.

Note: The ‘INC/DEC’ switch on the CAN Switch Box offers the same functionality as the on-screen rate bump buttons in both the manual and automatic control modes.

- On-Screen Pressure or Fan Speed display - If an optional pressure transducer or fan speed sensor have been installed and configured, the field computer can display the monitored values on the Guidance screen. Select the ‘Enable On-Screen Pressure or Fan Spd’ option to display the Pressure for liquid products or the Fan Speed for granular products.

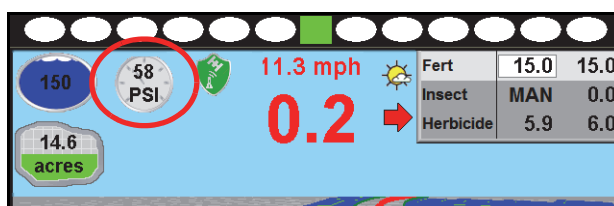

- Enable On-Screen Option - Select the ‘Enable On-Screen Option’ to select an optional second information display on the Guidance screen.

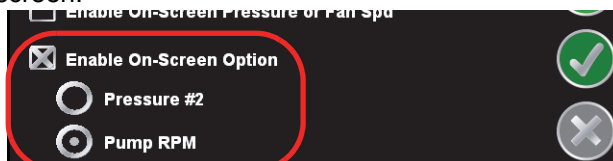

Select the ‘Pressure #2’ option to display pressure from a second optional transducer. The ‘Pump RPM’ option may be enabled to display the RPM of the corresponding injection pump.



Menu

Guidance path tools, field boundary tools, and additional guidance views are available by accessing the Menu in the lower right corner of the Guidance screen.

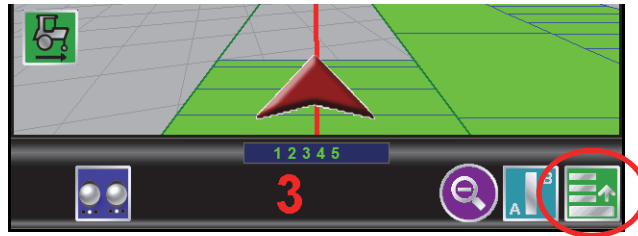

The features and tools available in the Menu will depend upon the selected view, active guidance pattern, and features enabled when the Menu was accessed. Review the following icons and their descriptions for help working within the Menu.

Home



Touch the Home icon to return to the Home screen. The job in progress will continue in the background. Note that some Tools Menu screens may not be accessible while a job is in progress.

Guidance Views

The down field and bird's eye views are the primary screens used while a job is in progress. These views seamlessly integrate guidance and navigation information with rate control information. This minimizes the amount of time which the operator must focus on the field computer and allows more time to manage other important aspects of the operation. Touching one of the following icons will switch the guidance view to the indicated perspective.



The Down Field view is the initial view displayed when a job is started. This is a simulated perspective as seen from the cab of the vehicle.

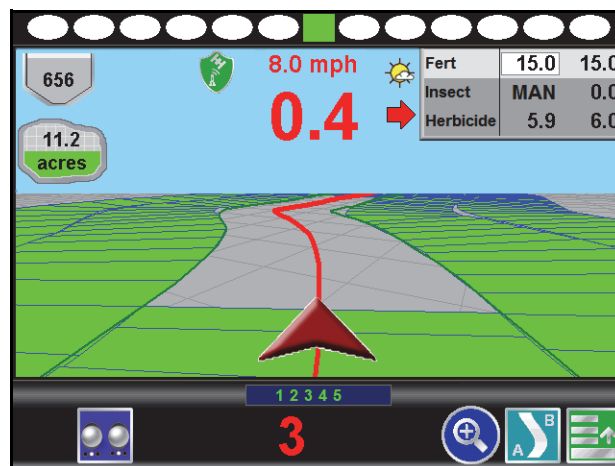



Switch to the Bird's Eye view to change to a view from above the vehicle position. This view will display all of the same guidance features and tools as the down field view.

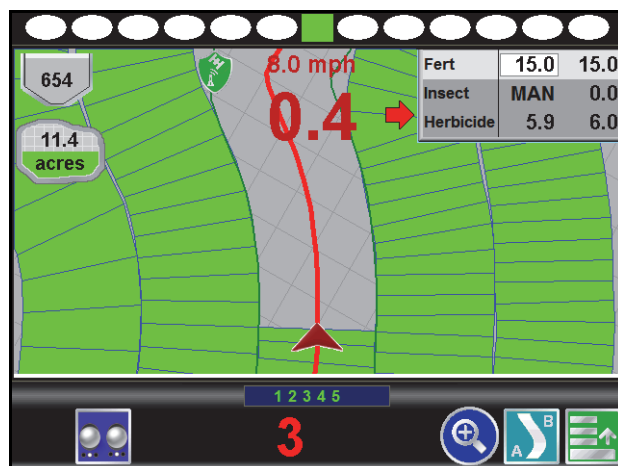

A-B Path Tools

The following tools and features may be found in the Menu when the Straight Line, Fixed Contour, or Pivot guidance patterns are active.

Note: *The following icons may not appear in the Menu at the same time. Tools may only be available before or after a guidance line has been set.*

Loading an A-B Line



If an A-B Line has been saved on the field computer, touch the Load A-B Line icon to load the saved line into the current job. This icon will not appear if an A-B Line has already been set. Reset the line to access the Load A-B Line tool.

Note: *The A-B Line must be stored on the field computer internal memory to be able to access and load the guidance path. Be sure to transfer all necessary files to the field computer before beginning a job.*

Names or descriptions of A-B Lines stored on the field computer cannot begin with a space.

Setting A-B Points

To create a new A-B line, the operator must set A and B points. The following icons and tools may be used to set a new A-B line.



Touching the Set A icon will place the first, or A, point of the path at the vehicle's current location. Regardless of where the vehicle moves from this point, the field computer will use the selected pattern to connect this point with the next set point. After the Set A icon is selected, the Set B icon will appear.



Touch the Set B icon to place the second, or B, point of the guidance path. Once the B point has been set, the field computer will use the selected pattern to create the guidance path displayed on the Guidance screen.

Set B by Heading

The Set B by Heading feature is only available with the straight line guidance pattern. This feature allows the operator to set an A-B line before completing the first swath.



Use the Set B by Heading feature to create a guidance path along a heading. Touch this icon and use the displayed keypad to enter a heading between 0° and 359° (with 0° being due North).

Note: *If Set B by Heading is selected before an A point has been set, the field computer will place the A point at the vehicle location when Set B by Heading was selected.*

A-B Path Tools

The following tools are available in the Menu when a compatible A-B line is displayed on the Guidance screen.



Select the A-B Tools icon to access additional tools for use with the current A-B line.



Select the Reset A-B Line icon to clear the displayed path. If the displayed path will need to be recalled in the future, be sure to save the current path before selecting reset.



Touch the Save A-B Line icon to save the displayed path. Once saved, an A-B line may be recalled at any time or loaded into other jobs. In addition, saved paths can be transferred from the field computer via the File Maintenance feature. See Chapter 8, *Software Updates and File Maintenance* for details on the file maintenance feature and transferring saved paths.

Note: *Names or descriptions of saved A-B lines cannot begin with a space.*



Use the Re-calibrate A-B Line tool to re-calibrate the displayed path to the machine's current position. Due to DGPS drift over time, this feature allows the operator to re-calibrate the A-B line to a known position in a field.

Nudge Feature

The Nudge Feature allows the operator to fine tune the displayed path for actual field conditions. For example, if the displayed path guides the vehicle too close to crop rows, nudge the line to the left or right to adjust the path and guide the vehicle away from rows.

Note: The Nudge Feature is only available with A-B guidance paths (Straight Line, Pivot, Fixed Contour).

The Nudge Feature works especially well with the Raven SmarTrax assisted steering systems. Contact a local Raven dealer for more information about these systems.

On-Screen Nudge Enabled

To enable and use the on-screen nudge feature to adjust a displayed guidance path:

1. Begin a job and set A and B points for a guidance path using the Straight Line, Fixed Contour or Pivot patterns.
2. Select the Menu icon in the lower, right corner of the display and select the Edit Nudge icon to display the In Job Nudge Settings screen.

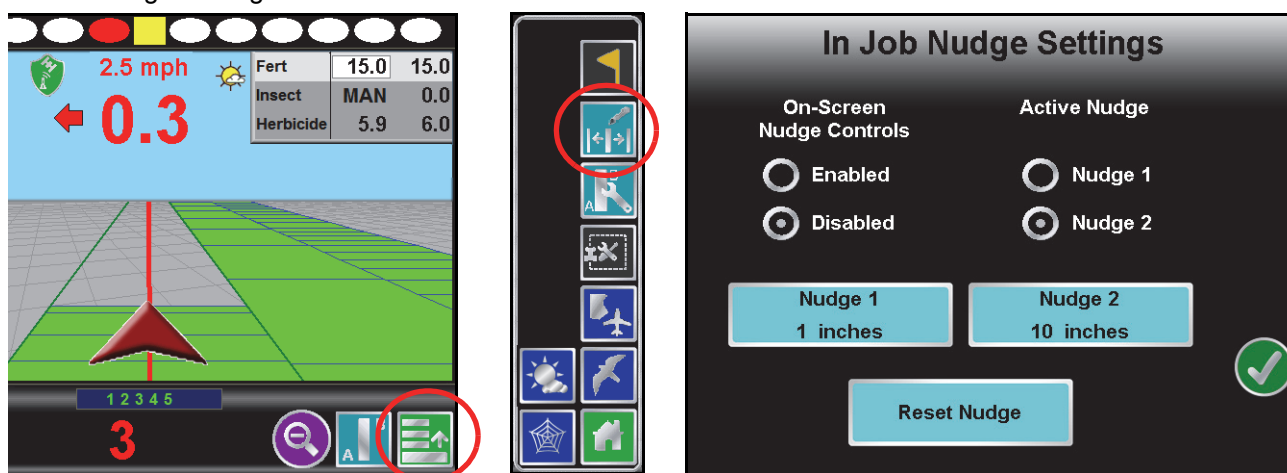

Note: Touch the Reset Nudge button at the bottom of the Nudge Settings screen to reset any adjustments to the path displayed on the Guidance screen.

3. On the Nudge Settings screen, select the 'Enabled' radio button to display the nudge control icons on the Guidance screen during field operations.
4. Touch the Nudge 1 and Nudge 2 buttons and use the on-screen keypad to enter the desired values for each nudge setting. Select the desired units for the entered nudge value and touch the Accept icon to return to the Nudge Settings screen.
5. Select either the 'Nudge 1' or 'Nudge 2' radio button to select the active nudge applied when the on-screen nudge controls are used. During field operations, the active nudge radio buttons may be used to quickly select one of the pre-configured nudge values.

6. Touch the Accept icon to return to the Guidance screen.

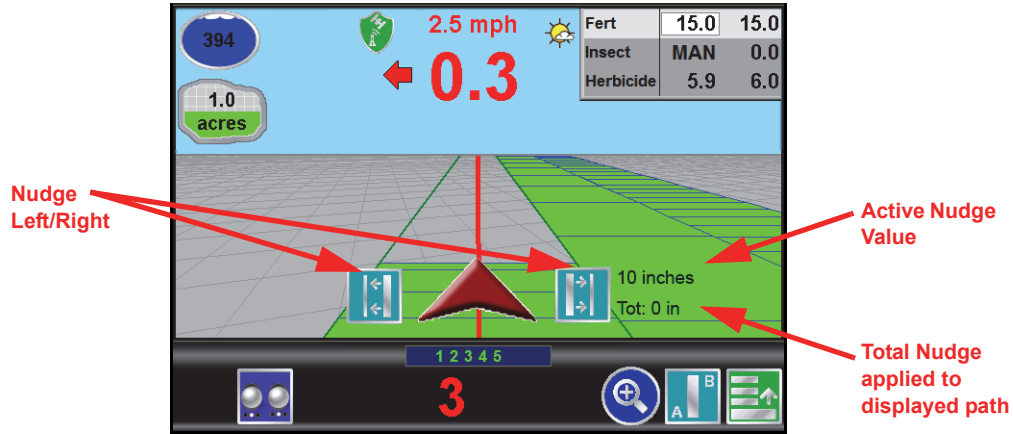

The following icons will be displayed on the Guidance screen if the on-screen nudge controls option is set to enabled.

| | | | |
|--|--|--|--|
| | <p>Touch the Nudge Right icon to move the displayed guidance path to the right. The distance which the path will be nudged is determined by the user defined value for the active nudge.</p> | | <p>Touch the Nudge Left icon to move the displayed guidance path to the left. The distance which the path will be nudged is determined by the user defined value for the active nudge.</p> |
|--|--|--|--|

Guidance Menu Nudge Tools

The nudge feature may also be accessed via the Guidance menu to make small adjustments to the guidance path if the on-screen nudge tools are not enabled. To Nudge a displayed guidance path without the on-screen nudge controls:

1. Begin a job and set A and B points for a guidance path using the Straight Line, Fixed Contour or Pivot patterns.
2. Select the Menu icon in the lower, right corner of the display and select the A-B Tools icon.

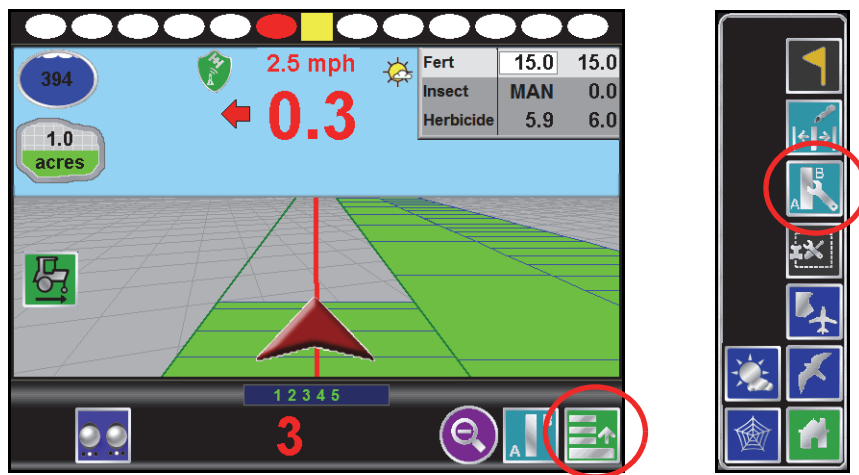

The following nudge icons are available in the Menu:

| | | | |
|--|---|--|---|
| | <p>Touch the Nudge Right icon to move the guidance path to the right in 1 inch [2 cm] increments.</p> | | <p>Touch the Nudge Left icon to move the guidance path to the left in 1 inch [2 cm] increments.</p> |
|--|---|--|---|

Field Markers

Field markers allow the operator to mark locations such as well heads, rock piles, or points of interest during a field operation. Markers will be displayed during the operation and will allow the operator to view the marker information.

To place a field marker:

1. Touch the Menu icon in the lower, right corner of the guidance display.
2. Select the Marker icon. A field marker will be placed at the current vehicle location.

Touch the marker to access marker information or delete the field marker.

Note: *Field markers are independent of job information and will be displayed for subsequent jobs in the area of the field marker.*

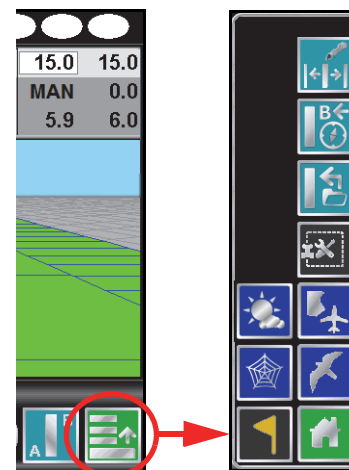

Marker Information

Touch the base of the marker and select the Information icon to display the Marker Information screen. This screen displays the marker name, current distance to the marker, and geographic coordinates.

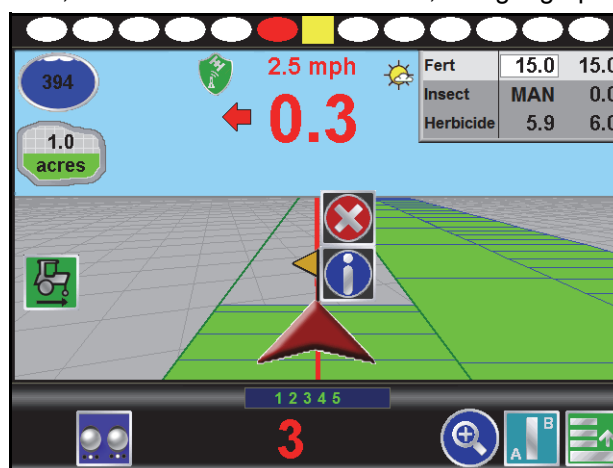

Touch the name field and use the on-screen keyboard to rename the marker.

Note: *Marker names should not begin or end with a space.*

Delete Markers

To delete a marker, touch the base of the marker and select Delete to remove the field marker.

Field Review Mode



Unlike the guidance views, the field review mode allows the operator to pan and zoom the display to any area of the field.

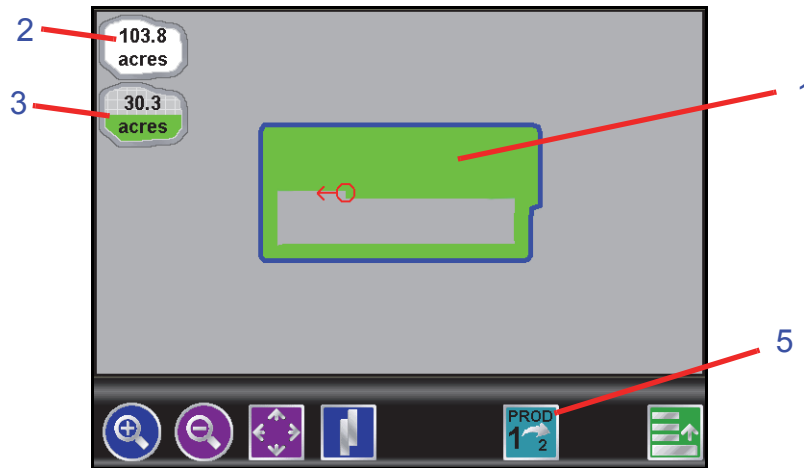

The field review mode displays the following information:

1. Coverage map
2. Area within a completed field boundary
3. Coverage area tally
4. Selected product

Field Review Mode Tools

In field review mode, the following icons appear along the bottom of the Guidance screen:

- Pan lock
- Show overlaps
- Switch product

Pan Lock

The pan lock feature locks the current view in field review mode.



When the pan lock is disabled, the display will automatically scroll to the vehicle indicator as the indicator moves out of the current view. Disable the pan lock to always display the vehicle indicator while in field review mode.



When the pan lock is enabled, the display is locked to the current view regardless of the vehicle indicator position. The operator can manually pan and zoom with the pan lock enabled to view specific portions of a field while in field review mode.

To pan the display manually, touch the Field Review screen. The point touched will become the center of the field review display.

Show Overlaps

In addition to coverage, the field review mode can display application overlaps. The show overlaps feature displays areas where active sections entered a previously applied area and allows the operator to quickly review skips and overlaps on the same screen.



With the show overlaps feature disabled, the field review mode displays the covered areas (including overlaps) in a solid green color. Touch this icon to toggle the show overlaps feature.



When the show overlaps feature is enabled, application overlaps are displayed in red. Overlaps appear where application (i.e. active sections) cover previously applied areas. Note that the area covered will not display as an overlap unless product application has overlapped.

Select Product

The field review mode displays coverage information based upon the selected product. If only one product has been enabled, the product is always selected and the Select Product icon will not appear on the Field Review screen.

If additional products are enabled for the current job, touch the Select Product icon to cycle through the enabled products.

For Example:



Control channel 1 is currently selected. Touch this icon to cycle the Field Review screen to channel 2.



Control channel 2 is currently selected. Touch this icon to cycle the Field Review screen back to channel 1.

Toggle Maps on the Guidance Screen

During a job with an active prescription or zone map, the field computer will display either map on the Guidance and Field Review screens. If both a prescription map and a zone map will be used, the operator may toggle which map to display on the guidance and field review screens by selecting the toggle maps icon.

To toggle the displayed map, touch:



The view zone map icon to view the loaded zone map.



The view prescription map icon to display the loaded prescription map on all guidance displays.

Field Boundaries

A field boundary and zone map may be created for each job on the Envizio Pro field computer.

Field Boundary

A field boundary provides a visual reference of the outline of the current field on the display.

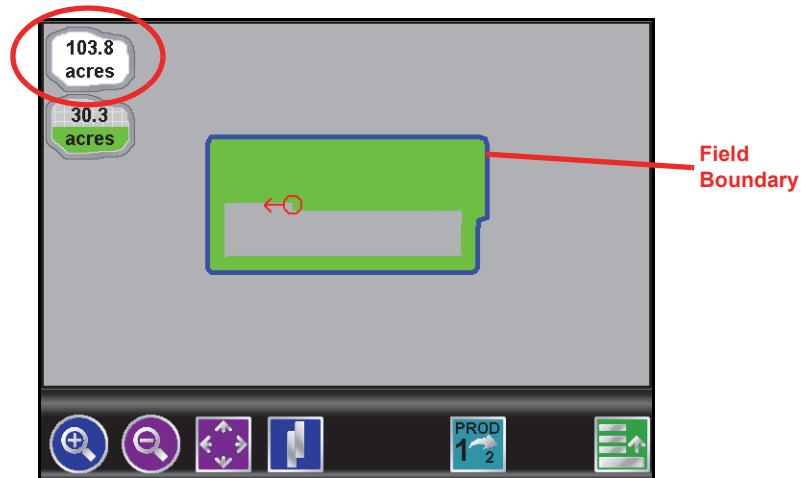

Once a field boundary has been completed, the Envizio Pro can calculate and display the area within the field boundary in acres (English) or hectares (Metric) in field review mode. Only one field boundary may be recorded per job.

If the optional AccuBoom, automatic section control, system is enabled, a field boundary will also create a basic zone map of the current field. Refer to Chapter 9, *Using AccuBoom™*, for more information on field boundaries with the AccuBoom system or contact a local Raven dealer for more information about the Raven AccuBoom system.

Zone Maps

If the optional AccuBoom, automatic section control, feature is enabled, a map of spray and/or no-spray zones may be created and saved with the job. Refer to Chapter 9, *Using AccuBoom™*, for more information on field boundaries with the AccuBoom system or contact a local Raven dealer for more information about the Raven AccuBoom feature.

Field Boundary Tools

The following Menu tools and features are available while creating a field boundary.

Note: *Zone maps are only available if the Raven AccuBoom, automatic boom section control, feature is enabled. Refer to Chapter 9, Using AccuBoom™, for more information using the AccuBoom feature or contact a local Raven dealer for more information about the Raven AccuBoom system.*

Loading a Field Boundary



A previously recorded boundary may be loaded into the current job file by selecting the Load Field Boundary icon in the Menu. A list of job files or boundaries stored on the field computer is displayed. Select the desired boundary to load into the current job.

Note: *Field boundaries exported from the Envizio Pro will be named either using the job file name entered when the job was started or the Zone Map name set for the map created during the job. Shapefile boundaries may be renamed on a PC or laptop computer and re-imported to the Envizio Pro for future operations.*

Recording a New Field Boundary



Touch the Record Field Boundary icon to begin recording a new field boundary. While a field boundary is being recorded, the Pause and End Field Boundary icons (see the following icon descriptions) are displayed on the Guidance screen.

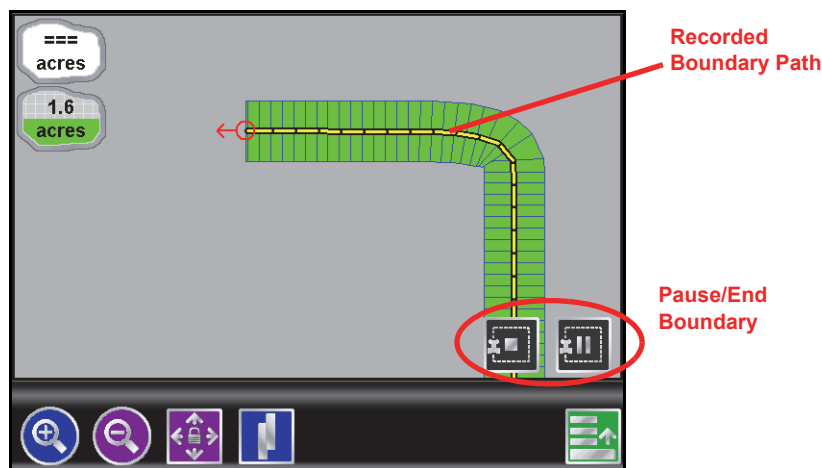

Pause, Resume and End Boundaries

The following icons will appear on the Guidance screen while a field boundary is being recorded.

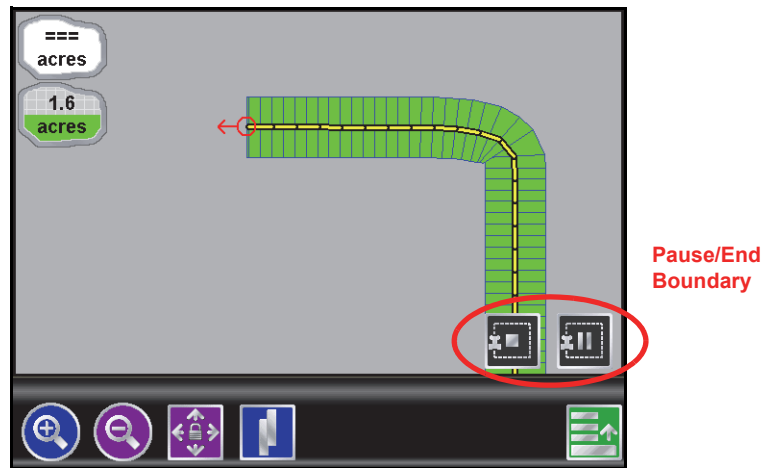

Touch the Pause Boundary icon to pause recording of the field boundary. Use this feature when the vehicle's path will not reflect the boundary such as when re-filling tanks, etc. To resume recording, touch the Resume icon.



While paused, the Resume Boundary icon replaces the Pause and End Boundary icons on the Guidance screen. Touch this icon to resume recording of the current boundary.



To finish recording a boundary, touch the End Field Boundary icon. Note that the field computer draws a straight line from the boundary starting point to the vehicle's current location when closing a boundary.

Boundary Tools

Once a field boundary has been completed, the following tools will be available through the Menu on the Guidance screen.



Touch the Boundary Tools icon to display additional boundary tools available for the current job.



Touch the Delete Boundary icon to reset the current field boundary. A field boundary must be present in the current job or this icon will not appear in the Menu.

AccuBoom™ Tools

Additional tools and features may be available in the Menu if the optional AccuBoom system is enabled for the current job. Refer to Chapter 9, *Using AccuBoom™*, for more information using the AccuBoom feature or contact a local Raven dealer for more information about the Raven AccuBoom system.

Drift Shift

Note: The drift shift feature must be enabled prior to starting a job to allow the following features to be available during the field operation. Refer to Drift Shift section on page 134 for assistance with the drift shift settings.

Manual Coverage Adjustment

To manually adjust the reported position of all job features:

1. Touch the Menu icon in the lower, right corner of the guidance display.
2. Select the Drift Shift icon.

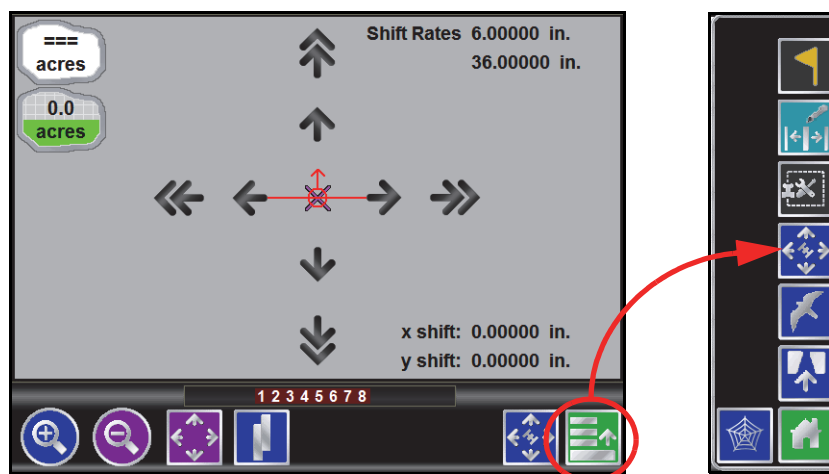

3. Use the fine and coarse nudge arrows on the screen to adjust the field features displayed to the actual vehicle location. As the job features are adjusted, the cumulative nudge applied in each direction is displayed in the lower, right corner of the display.
4. Touch the Menu icon and select the Accept button to accept the applied drift shift values and return to the Field Review mode or Cancel to undo the applied shift adjustments.

Reference Point

Note: When the drift shift feature is enabled, the field computer will automatically place a reference point at the start of each job. The reference point will allow the machine operator to quickly shift field features by shifting all field features based upon the current vehicle position and the reference point set or configured by the machine operator.

Reference Point Settings:

1. Touch the Menu icon in the lower, right corner of the guidance display.
2. Select the Drift Shift icon.

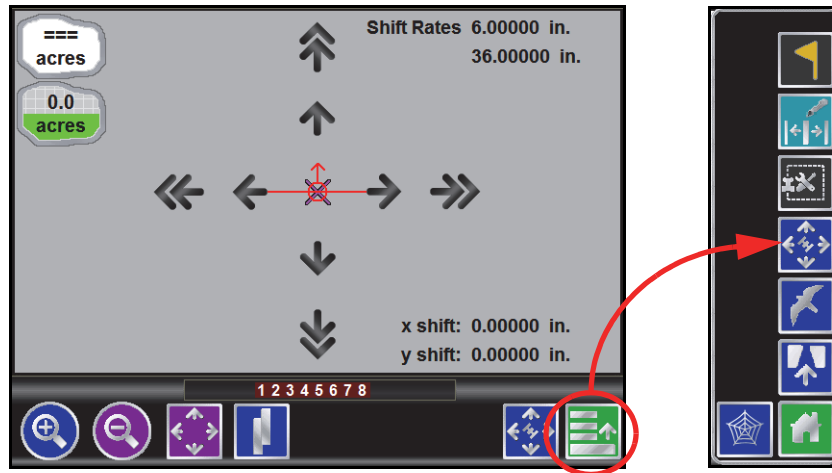

3. Touch the Drift Shift icon displayed in the lower, right corner of the display to access the Drift Shift Settings screen. Use the following features to set the reference point or shift the coverage features:

Set Drift Correction Now. With the vehicle positioned at the actual reference point, touch the “Set Now” button to shift the reference point and all field features to the current vehicle position.

Set Reference Point Here. Touch the “Set Here” button to reset the reference point to the current vehicle location. The previous reference position will be lost.

Prescription Maps and Variable Rates

With the optional variable rate application (VRA) feature enabled, the Envizio Pro is capable of using a prescription map to automatically change the target application rate.

Envizio Pro field computer uses the shapefile format for prescription maps used to provide variable rate product control. If the variable rate feature is activated, a prescription map, created using GIS (Geographic Information Systems) software capable of creating shapefiles, may be transferred to the field computer. These shapefiles must be in a polygon shape format that complies with the ESRI (Environmental Systems Research Institute) shapefile specifications and must also be in the WGS (World Geodetic System) 84 datum.

The .shp, .shx, and .dbf files required to create a shapefile prescription map must be saved to the rxMaps folder on a USB flash drive to allow the field computer to locate and transfer the required files to internal memory. Refer to the Chapter 8, *Software Updates and File Maintenance*, for additional assistance with performing file maintenance or creating the required folder structure on a USB flash drive for use with the Envizio Pro.

To ensure peak performance of the field computer during variable rate applications, create maps with a minimum number of zones. Maps with too many zones may yield undesired results or limit performance of the field computer. To help limit the number of zones within a map, use the equipment, or Guidance, width as a guide. The smallest zones on the map should be no smaller than the width of the equipment applying the product. For example, if the boom on a sprayer is 90 feet [27 m] wide for each swath, zones within the prescription map should not be less than 90 feet [27 m] square.

If the prescription map contains zero rate zones, the system must have either a PWM or Fast valve controlling product. The valve type and valve cal programmed on the field computer must be set to PWM Close or Fast Close mode, depending upon which valve is installed in the system. See the *Prescription (Rx) Settings* section on page 112 for additional prescription map set up information.

Note: *If the optional AccuBoom system is enabled, AccuBoom will turn off sections valves in zero rate zones.*

Loading Prescription Maps

Prescription maps are loaded onto the field computer using the File Maintenance features described in the *File Maintenance* section on page 140.

Prescription maps must have three separate files, each with the same file name. A file with the .shp, .shx, and .dbf file extensions are all essential for each prescription map to function correctly. If any of these files are missing, or named differently, from the rxMaps folder, the field computer will not be able to load the prescription map.

Note: *Names of prescription map files loaded on the field computer cannot begin with a space.*



Applying Prescription Maps

A prescription map may be applied to any enabled product during the Start Job process. With the variable rate feature enabled, the Start Job - Verify Settings screen displays the name of the prescription map along with the product to which the prescription map will be applied.

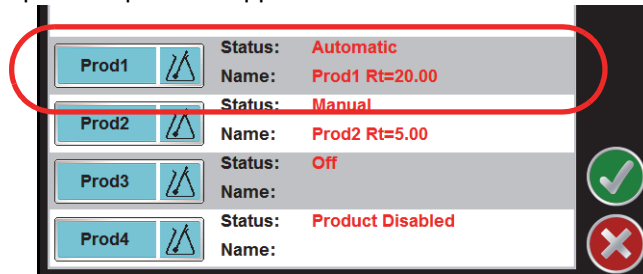

To Apply a Prescription Map

1. Touch the Rx symbol in the corresponding Product button.



For example, touch the Rx symbol in the Product 1 button to apply a prescription map to the product controlled by the first product node.

Note: To remove a prescription map, touch the 'Prod1' area of the button to display the Product Setup screen. Touch the Rate button and enter a value.

2. A list of available prescription maps is displayed on the Start Job - Select Rx Map screen.

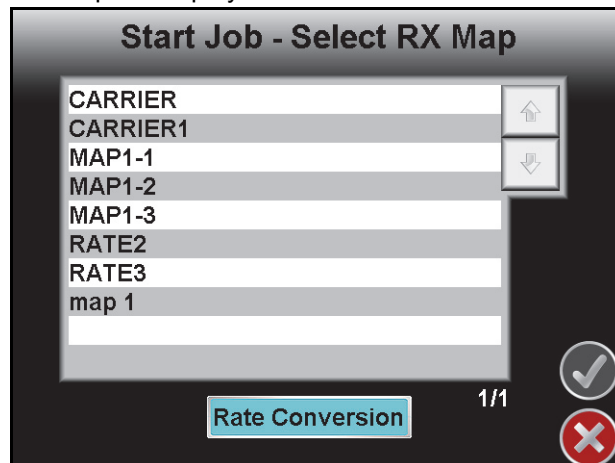

Select the name of the prescription map to apply to the selected product and then touch the Accept icon to apply the prescription map.

Note: To modify the rates within the selected prescription map, select the Rate Conversion button. Use the on-screen keypad to enter the multiplier of the prescription map for the current job.

3. Verify other job settings before beginning the job. Refer to the *Starting a Job* section on page 56 for more information.

Using Prescription Maps

The field computer will display the prescription map used during product application on the guidance screens.

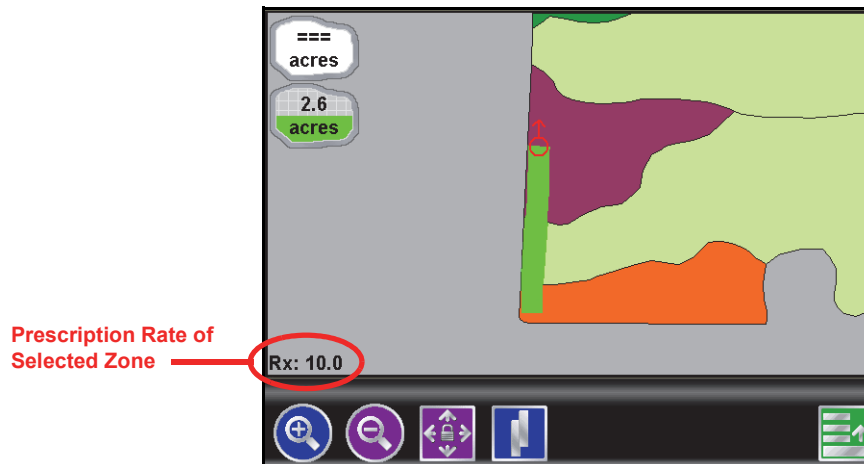

To display the prescription rate for any zone displayed in the prescription map while in the field review mode, touch the desired zone on the screen. The display will center the location touched on the screen and display the prescription rate in the lower, left corner.

System Alarms

Important warning and alert information is immediately displayed on the screen in the Alarms area.

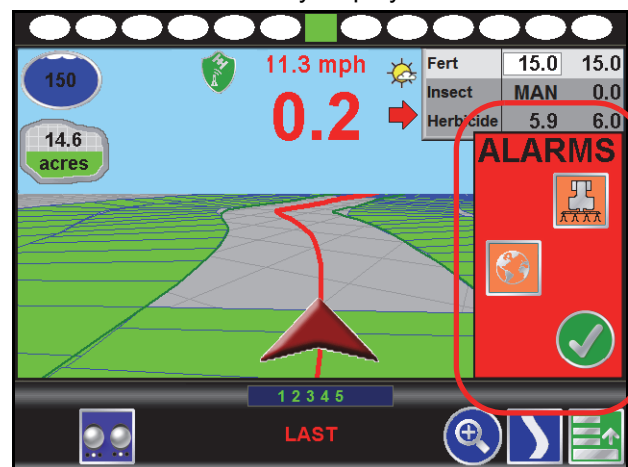

The Alarms area displays icons representing the portion of the system which requires the operator's attention. In addition to visual alarms, the operator may wish to enable the audible alarms feature of the Envizio Pro field computers.

Alarms Area

Depending upon the alert or warning condition, the field computer may display one or more of the following icons:



Touch any of the displayed icons to display information regarding the corresponding alarm.

- The Product Control Alarm icon is displayed if an alarm condition such as a low bin or tank, or when product control cannot reach the target rate.
- The AutoBoom Alarm icon is displayed if an alarm condition such as sensors too low or high, the pressure is higher than the set point, or if a sensor has gone off line. Refer to Chapter 10, *Using AutoBoom®*, for more information about the optional Glide Series AutoBoom system and troubleshooting AutoBoom alarms.
- Touch the Show All Alarms icon to view all current alarm conditions.

Hiding the Alarms Area

Once the operator has reviewed any alert information, the Alarms area can be hidden to resume operation.

1. To hide the Alarms area, touch the green check mark icon.

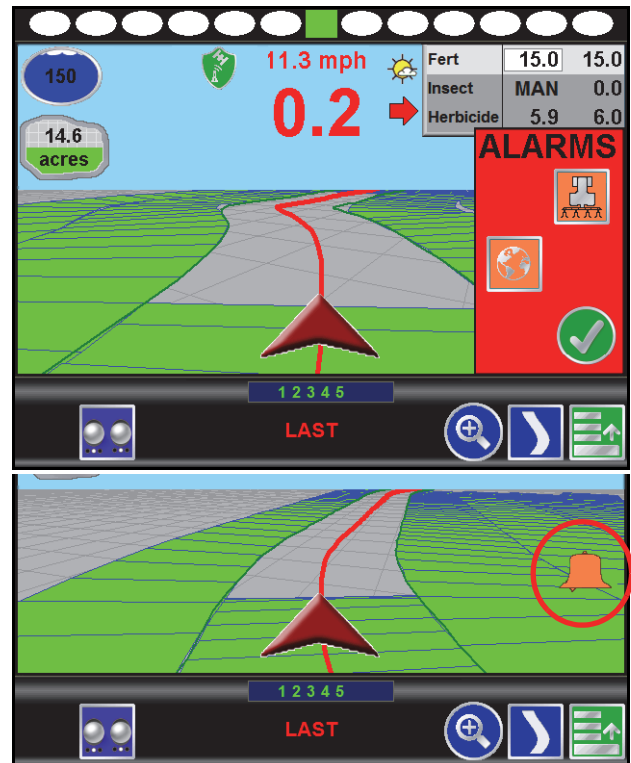

2. If the alarm condition still exists, an Alarm icon appears on the screen until the alarm condition has been cleared. Touch this icon to re-display the Alarms area.
3. For help clearing alarm conditions, refer to Chapter 11, *Troubleshooting*, for product control troubleshooting information. Refer to the *CAN AutoBoom® Calibration and Operation Manual* for information about using and troubleshooting the optional Glide Series AutoBoom system or the *OmniRow® Calibration and Operation Manual* for assistance with the OmniRow system.

Audible Alarms

Audible alarms are enabled by default. To disable the notification tone or change available alarm settings, see the *Alarm Settings* section on page 116 to setup the Audible Alarms.

CHAPTER

7

Tools Menu

Accessing and Navigating the Tools Menu

After the initial setup wizards are complete, all settings and configurations are accessible by selecting the Tools icon on the Home screen.



The Tools menu contains the following submenus:

- Wizard
- System
- GPS
- Computer
- Vehicle

Note: *Verify that the field computer is setup correctly for the job, vehicle, and application prior to starting an actual job application. See the Product Control section on page 99 to enter a test speed and check settings while the vehicle remains stationary.*

The Quick Access Bar appears along the top of the Main Tools menu screen.

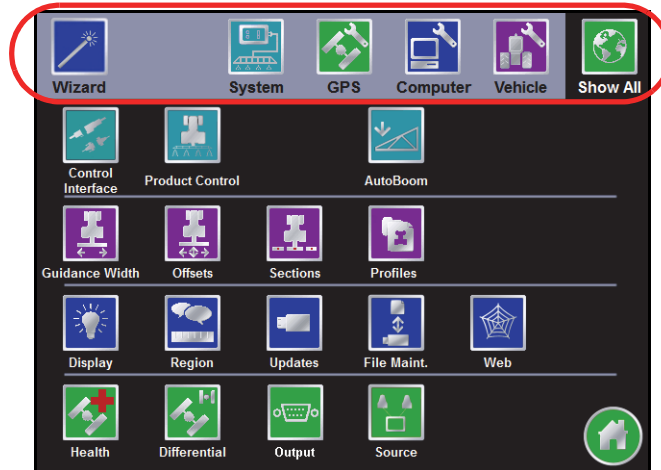

Touch any of the icons to display a detailed view of the selected submenu.

Wizard Menu



The Setup Wizard Menu is available in the Tools menu. Review the *Setup Wizards* section on page 42 for more details on using the setup wizards.

System Menu



Access the System menu to setup the product control system, or configure the optional AccuBoom or AutoBoom systems.

GPS Menu



Use the GPS menu to adjust the internal GPS receiver or to enable the field computer to receive DGPS from an external receiver. The GPS menu also contains screens to review the status of GPS reception, set message outputs (for the internal DGPS receiver only), or select the PRN.

Computer Menu



The Computer menu sets display and feature settings of the field computer. Access the Computer menu to change the display brightness, language, and units, as well as activate features or update the Envizio Pro software.

If the light bar interface option is enabled, the Computer menu will also contain options for adjusting the brightness of the external light bar. See the *Serial Port Configuration* section on page 98, for more information on setting the light bar interface.

Vehicle Menu



Access the Vehicle menu to setup or modify vehicle profiles for each machine or implement with which the field computer will be used. Profiles allow the operator to setup GPS antenna heights and offsets as well as the swath width and section setup for each implement once and quickly reload a vehicle's profile when transferring the Envizio Pro between vehicles.

Show All



Select the Show All icon to show an overview of the Tools menu. The Show All screen is displayed each time the Tools menu is accessed.

Navigation

The following icons will be used to navigate within the menu screens and to edit and save settings:



Touch the Home icon to return to the Home screen.



Touch the Accept icon to confirm any changes to a screen. Touching the Accept icon will save those settings and proceed to the next screen.



Touch the Cancel icon to exit the current screen without saving any changes made on a screen. If the Cancel icon is displayed in gray, the cancel feature is currently unavailable.



Like the Accept icon, the Next icon accepts changes and proceeds to the next screen in a setup procedure. Touch this icon where it appears to access more settings or to continue a setup procedure. The last screen in a setup procedure should display the Accept icon.



Touch the Previous icon to return to the last screen displayed during a setup procedure or wizard.



The Up icon, where it appears, increases displayed values in preset increments. Touch this icon to increase a value until the desired value is displayed.



The Down icon, where it appears, decreases displayed values in preset increments. Touch this icon to decrease a value until the desired value is displayed.

On-Screen Keyboard

Data entry on the Envizio Pro is quick using the full, on-screen keyboard.

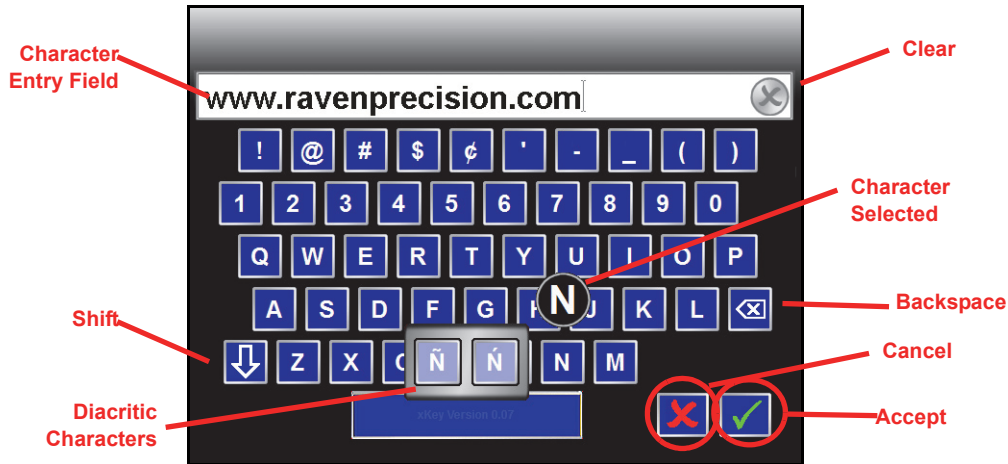

This keyboard is displayed when entering or modifying profile, product, or job names or while browsing the web with a wireless modem. The following features may be used with the keyboard:

Character Entry

When the keyboard is touched, the character selected will display above the key. If the character displayed is not the character intended for entry, continue touching the screen while dragging to the correct character to enter. The character will not be entered in the character entry field until the touch is released.

If the Envizio Pro is set to a language with diacritical signs (e.g. accent, grave, tilde, etc.), these special characters may be entered by:





1. Touch and hold the desired basic character for approximately 3 seconds.
2. Drag drag to the diacritic character in the popup displayed.
3. Release the touch to enter the selected character.

Note: *Diacritic symbols are only available if the language selected on the Envizio Pro contains these characters.*



Shift/Caps Lock

The keyboard displays the character set that will be entered in the character field when any of the keys are selected. To shift the character set to lowercase, touch the  key.



Note: *The keyboard automatically capitalizes the first character entered into the character entry field. To cancel this feature, touch the  key before entering characters using the keyboard.*

Touch the  key to enter the next character using the uppercase character set. Double tapping the  or  keys will enable caps lock and display the  key. Touch the  key again to disable caps lock

Symbols

When browsing the web using the field computer, the  key will be displayed on the keyboard. Touch the  key to display the symbols keyboard. Touch the  key to return to the alphabetic keyboard.

Backspace and Clear

Touch the  key to delete the previously entered character or the  icon above the keyboard to clear all characters within the character entry field.

Accept/Cancel

Touch the  key on the keyboard to accept the text or characters displayed in the character entry field. The displayed text or characters will be entered in the selected text field on the previous screen.

Touch the  key to return to the previous screen without entering the keyed text or characters.

System Menu

The System menu contains the options for setting up how the Envizio Pro will interface with the product control hardware. The System menu also contains setup screens for the optional AccuBoom, AutoBoom systems. Touch the System icon in the quick Access Bar to display a detailed System menu screen.

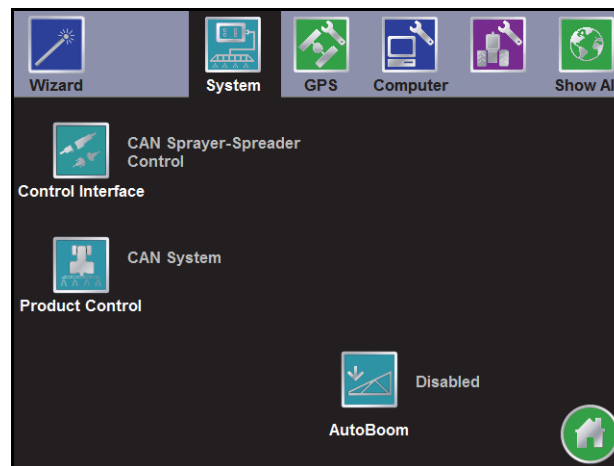

Control Interface

The multi-functional capabilities of the Envizio Pro means that the field computer is capable of interfacing with various control and monitoring systems. To function properly in any one of the possible systems, the field computer must be set up to receive application information from the correct source.

The following sections describe the options displayed on the Control Interface screen and will help with selecting the appropriate product control and available options for the system.

Product Control Options

The product control options configure the Envizio Pro to monitor or control product application, coverage or harvest operations. The following options are available for use on the field computer:

Note: *If the Envizio Pro will be connected to a CANbus with another CAN controller (such as a Raven SCS 4400/4600) with AccuBoom, be sure the control interface option is set to 'None.' This option allows the field computer to monitor CANbus nodes without trying to control product nodes. In this configuration, the boom master options will not be displayed.*

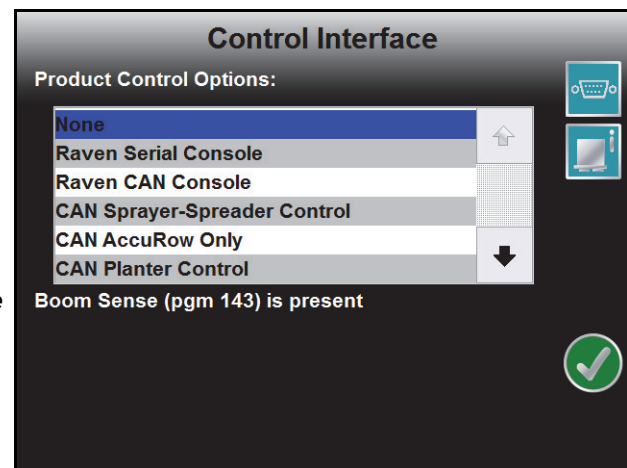

None

Select 'None' if the Envizio Pro will not be controlling product application (e.g. towing a disc, plow or rake). With this option selected, the Envizio Pro will only provide guidance for field operations.

Raven Serial Console

This option is used when the field computer is connected to another Raven product control console, such as a Raven SCS 440 or SCS 460, connected to the "Console" port on the interface cable. In this configuration, the field computer will monitor and display application information sent from the Raven console.

The Envizio Pro receives application information such as rate and boom status to create an as-applied or coverage map. This information is also used by the field computer when providing guidance. The field computer can still be connected to an optional CAN AccuBoom node for automatic section control. In this configuration, the field computer and AccuBoom will automatically control boom sections according to saved field boundaries. The optional AutoBoom system can also be controlled by the field computer in this mode to provide automatic boom height control.

Raven CAN Console

This option should be used when another control console will be used to control product nodes on the CANbus. In this configuration, the Envizio Pro field computer will only monitor and display application information sent over the CANbus.

Note: *Control inputs must be made via the CAN control console. The Envizio Pro product control features will not be available during application when set to the Raven CAN Console control option.*

CAN Sprayer/Spreader Control

Select 'CAN Sprayer/Spreader Control' if the field computer will be used to control up to four products (with required multi-product activation key) via a CANbus system.

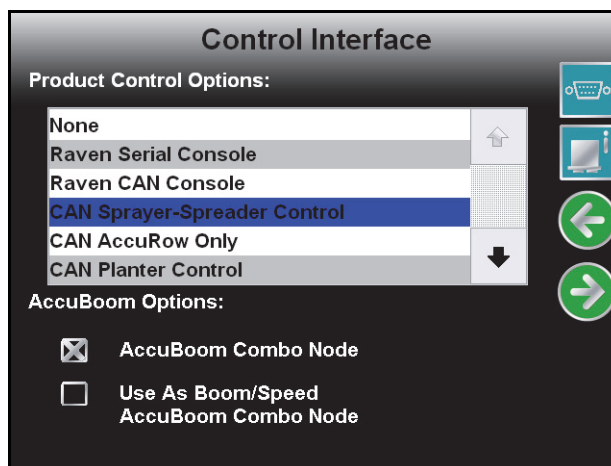

Note: *If more than one product node has been installed with the field computer, be sure to check that all product control nodes are addressed correctly before proceeding. Touch the CAN Information icon (shown right) and review the CAN Diagnostics section on page 30 to re-address the product nodes.*



The Boom Master Options list is replaced by AccuBoom Options if 'CAN Product Control' is selected. See the CAN Options section on page 97 for details.

CAN AccuRow Only

Select 'CAN AccuRow Only' if the field computer will be interfacing with an optional AccuRow system to provide automatic section control for a multi-section planter implement. Refer to the *AccuRow Calibration & Operation Manual* for additional set up and operation information.

CAN Planter Control

Select 'CAN Planter Control' if the field computer will be interfacing with an optional Raven OmniRow system. The OmniRow system allows the field computer to control seed population rate and offers AccuRow, automatic row or planter section shut off. Refer to the *OmniRow® Calibration & Operation Manual* for additional set up and operation information.

Bogballe Calibrator Zurf

The field computer may be used in conjunction with the Bogballe Calibrator Zurf console for guidance and monitoring of product applications using Bogballe weight systems. Refer to Appendix J, *Serial Console Interfaces*, for additional information.

Kuhn/Rauch LH5000

The field computer may be used in conjunction with the Kuhn/Rauch LH5000 console for guidance and monitoring of product applications using an existing Kuhn/Rauch system. Refer to Appendix J, *Serial Console Interfaces*, for additional information.

Amazone Amatron+

The field computer may be used in conjunction with the Amazone Amatron+ console for guidance and monitoring of product applications using an existing Amazone system. Refer to Appendix J, *Serial Console Interfaces*, for additional information.

Yield Monitor

Select 'Yield Monitor' if the field computer will be interfacing with an optional Raven SmartYield system to monitor and log yield and moisture data during harvest operations. Refer to the SmartYield Calibration & Operation Manual for additional information.

SmartYield Pro

Select 'SmartYield Pro' if the field computer will be interfacing with an optional Raven SmartYield Pro CANbus yield monitoring system to monitor and log yield and moisture data during harvest operations. Refer to the SmartYield Pro Calibration & Operation Manual for additional information.

OmniSeed

Select the OmniSeed option if the field computer will be interfacing with the optional Raven OmniSeed system to provide seed rate control for an air seeder system.

Note: *A registration code is required to interface with the Raven OmniSeed system. If attempting to select OmniSeed during the initial start up, select 'None' for the product control option to complete the wizard.*

Contact a local Raven dealer for more information and to purchase the required activation key. Refer to the Special Features Registration section on page 138 for instructions on entering the OmniSeed activation key before setting up the air seeder control system.

Boom Master and System Options

The available system or boom master options allow the operator to select the preferred method to toggle recording of the coverage map. Depending upon the product control system and any detected CAN hardware, the following options may be available to configure the input of the master switch used with the field computer:

None/Raven Serial Console

The following options are available if the product control options is set to either 'None' or 'Raven Serial Console':

Note: *If the Envizio Pro is connected to a CANbus with another CAN controller (such as a Raven SCS 4400/4600) with AccuBoom, be sure the control interface option is set to 'None.' This option allows the field computer to monitor CANbus nodes without trying to control product nodes. In this configuration, the boom master options will not be displayed.*

Envizio Pro Boom Sense Wire. Select this option if the boom sense wire has been connected as instructed in the *Boom Sense Wire* section on page 23.

On-Screen Vehicle Arrow. This option allows the operator to touch the Vehicle Arrow (shown to the right) displayed on the Guidance screen to toggle the coverage history on or off.



AccuBoom™ Master Switch. If the orange/white wire on the optional AccuBoom node harness has been connected, select the 'AccuBoom master switch' option to create the coverage map based upon the section information reported by the AccuBoom node.

CAN Options

If CAN Sprayer/Spreader Control is selected as the product control option, the list of available boom master options is replaced by the following CAN AccuBoom options.

AccuBoom Combo Node. Do not select the 'AccuBoom Combo Node' option if an optional AccuBoom system has not been installed on the CANbus.

If an AccuBoom Combo node (P/N 063-0172-714) is present on the CANbus, select this option. The following option will be available in the AccuBoom Options list.

Use as Boom/Speed AccuBoom Combo Node. This option will only appear if the 'AccuBoom Combo Node' option is selected. Select this option to use the AccuBoom combo node as the boom/speed node. If this option is selected, a separate boom/speed node is not required for the CANbus system.

If 'CAN AccuRow Only' or 'CAN Planter Control' is selected, the boom master options displays the available options for CAN planter control.

Reverse Sensing. The reverse sensing feature may be enabled or disabled from the Control Interface screen. Refer to the *Reverse Sensing* section on page 121 for details about using this feature or to enable or disable the feature from the GPS menu.

On-Screen Vehicle Arrow. This option allows the operator to touch the Vehicle Arrow (shown to the right) displayed on the Guidance screen to toggle the coverage history on or off.



AccuRow Master Switch. If an optional AccuRow system has been installed with the field computer, select the AccuRow master switch option to create the coverage map based upon the section information reported by the AccuRow node.

If the 'OmniSeed' option is selected, the following option may be enabled.

Remote Master. Select this option if a remote master switch or proximity switch is connected to the "Remote Switch" connector on the chassis cable.

Serial Port Configuration

To control an external serial device with the field computer:

1. Select Control Interface from the System menu.
2. On the Control Interface screen, touch the Serial Port icon in the upper right corner.

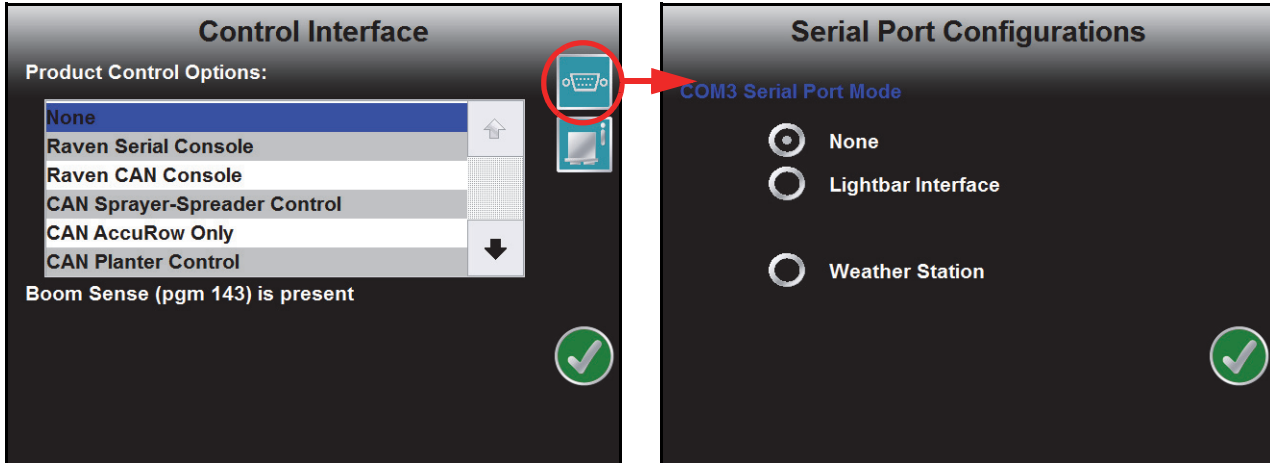

The following screen and options are displayed.

None. Select this option if no serial device is connected to the field computer.

Lightbar Interface. Select this option to allow the field computer to control an external light bar connected to the connector labeled 'COM3/Light Bar' on the auxiliary interface cable (P/N 115-0171-745) or chassis interface cable (P/N 115-0172-001).

Note: Refer to the *Display* section on page 135 to adjust the brightness of the external light bar via the field computer interface.

Weather Station. Select this option to connect an optional WatchDog Sprayer Station to the Envizio Pro field computer. Depending upon the current system and connected controllers, the weather station may be connected to either 'COM2/Console' or 'COM3/Light Bar' ports on the interface or chassis cabling. Refer to Appendix D, *Weather Station*, for additional assistance with connecting and configuring the field computer and WatchDog Sprayer Station.

CAN Diagnostics

The CAN Diagnostics screen displays the software version, software revision, and program number for each node detected on the CANbus.

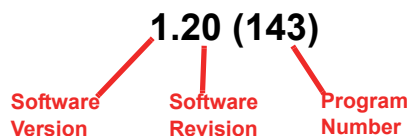

Review the *CAN Diagnostics* section on page 30 for additional information on the CAN Diagnostics screen and readdressing or restarting CANbus nodes.

Product Control

The Product Control menu displays the current settings and calibration values for the selected product. If additional product control nodes have been detected by the control system, touch the Select Product icon in the upper, right corner of the screen to cycle through detected product nodes or control channels.

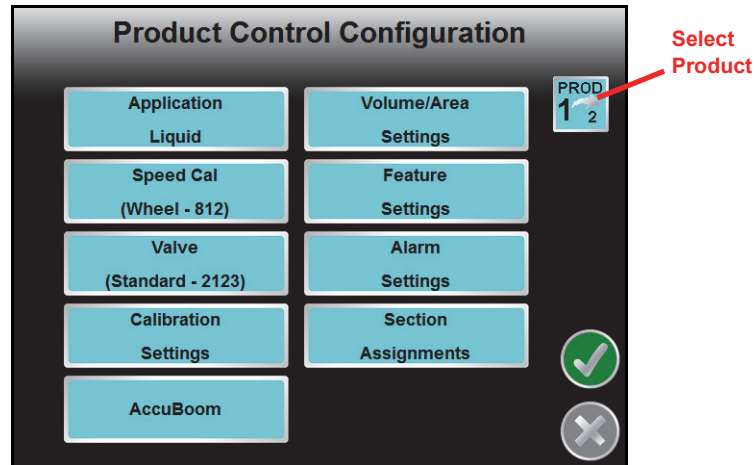

The Product Control Configuration screen contains several of the calibration numbers which the field computer requires to provide product control.

Access the product control configuration to adjust the following settings for the product control system:

- Application type
- Speed sensor type and cal
- Valve type and cal
- Product control node cal values
- Volume and area settings
- Feature settings
- Alarm settings
- Section assignments

Application Type

Touch the Application button on the Product Control Configuration screen to access the Application Type screen.

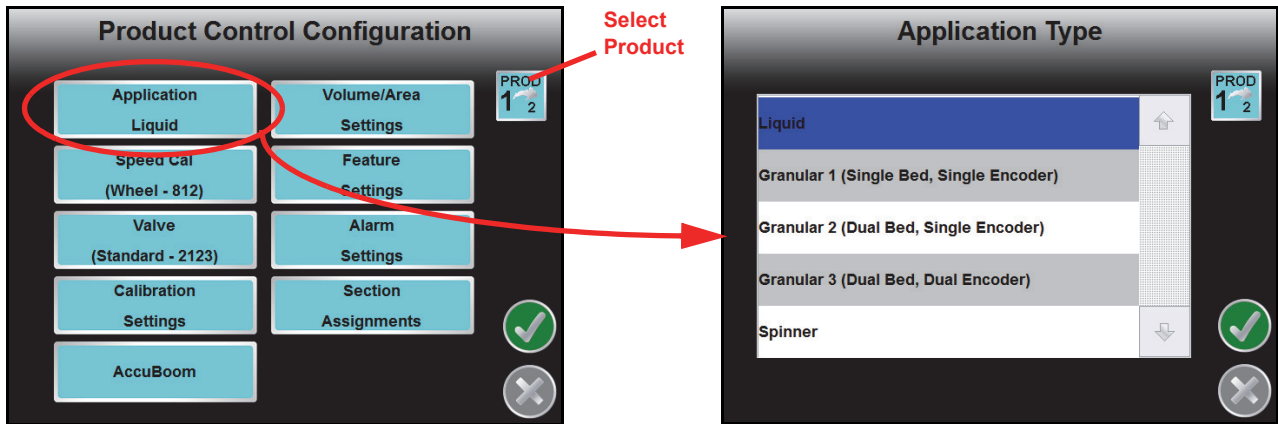

Note: The Application button displays the current application type selected.

The application type selection configures how the field computer will interpret information from the control nodes and must be set correctly to ensure that the field computer interfaces with the product control hardware correctly. Select one of the following application types for the displayed control channel.

Note: Some application types may require a specific node firmware version, optional CANbus control hardware or an optional activation key. If an application type selection is not available, contact a local Raven dealer for assistance.

Liquid. Application of a liquid product.

Gran (Granular) 1. Dry or granular product application using a single encoder to meter application equipment with a single bed.

Gran (Granular) 2. Dry or granular product application using a single encoder to meter application from equipment with a dual bed.

Gran (Granular) 3. Dry or granular product application using a dual encoder configuration to meter application from equipment with a dual bed.

Gran (Granular) 4. An air seeder system on which a seed gate or segmented meter roller is used to control seed for active sections before the seed has entered the air system. Most air seeder control systems will be controlled using this application type selection.

Gran (Granular) 5. An air seeder system on which a manifold or distribution bin is used to control air flow to active sections after the seed has entered the air system. This application type will control the RPM of the meter roller based upon active drill sections.

Note: An optional OmniSeed authorization key is required for Gran 4 and Gran 5 application types to enable the field computer to control air seeder control systems. Contact a local Raven dealer for purchasing information and refer to the Updates section on page 138 to enter the activation code to unlock the Gran 4 and Gran 5 application type selections.

Spinner. Select this option for RPM control of spinner speed during field operations.

Injection. Select this option for Pump RPM control of an injection pump during field operations.

NH3. An option for anhydrous ammonia rate control operations will be available if the product node is capable of specific rate control features. It is recommended to ensure this option is available and selected when controlling the application of anhydrous ammonia during field operations.

NH3 Pump. The anhydrous pump control selection will be available if the product node is capable of specific control features for the AccuFlow HP boost pump. Select this option to allow the operator configure specific boost pump control features for field operations.

AccuFlow HP+. Select the AccuFlow HP+ option if controlling a Raven AccuFlow HP™ Plus system with the Vortex cooler for anhydrous ammonia applications.

Note: *Select the AccuFlow HP+ option only if an AccuFlow HP™ Plus system will be controlled by the field computer. Contact a local Raven dealer for additional assistance.*

Speed

The Speed button displays the current speed calibration value. Touch the Speed button to display the Speed Cal screen.

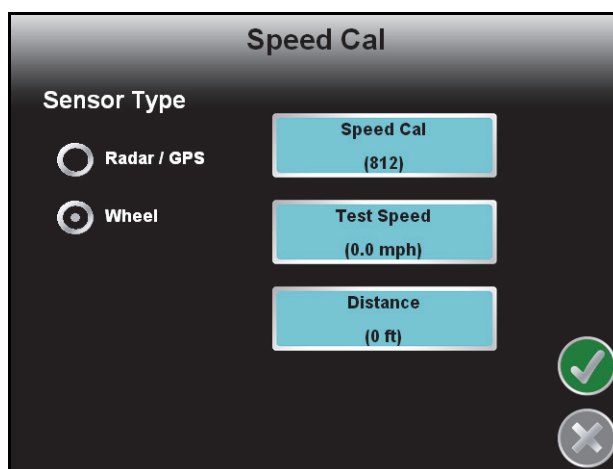

Sensor Type

Select the type of speed sensor to be used with the Envizio Pro control system.

Speed Cal

The current speed cal is displayed on the Speed Cal button. Touch the Speed Cal button and use the on-screen keypad to enter a speed cal value.

Raven Industries recommends the following speed calibration values for initial system setup.

| Sensor Type Setting | Used with | Recommended Initial Speed Cal | |
|---------------------|--------------------------------|-------------------------------|--------|
| | | English | Metric |
| Radar/GPS | External Raven GPS Receiver | 785 | 199 |
| | Internal DGPS Receiver | 812 | 206 |
| | GPS Speed over CANbus | 1000 | 1000 |
| | Raven Radar | 598 | 152 |
| Wheel | Wheel Magnets | 1000 | 254 |
| | Speedometer Drive Speed Sensor | 612 | 155 |

These values are good starting points and generally yield adequate results, however, the speed cal should be refined for the specific vehicle and speed sense system. See Appendix A, *Calculating the Calibration Values*, for instructions on refining the speed cal value.

Note: *The GPS speed over CANbus feature is only available with specific Raven speed sense nodes. This feature utilizes NMEA speed over ground data transmitted over the CAN network which eliminates the need for a separate, external speed sensor.*

| | |
|--|---------------|
|  | NOTICE |
| <p>When using the GPS speed over CANbus feature, no tuning or adjustment is necessary or recommended to the speed cal value. Losing GPS signal for more than a second will also result in loss of the CAN speed signal which may affect product application in progress.</p> | |

Test Speed

The test speed may be used to simulate speed when testing or troubleshooting the product control system. Enter a value approximately equal to normal application speeds to allow the field computer to control product application functions while the vehicle remains stationary. The test speed is useful for troubleshooting the CAN and product control systems.

Note: *A speed cal must be entered to allow the test speed feature to function.*

The test speed area displays the current test speed. Touch this area to enter a test speed.

Note: *The test speed will clear if the field computer receives a pulse from the actual speed sensor. To keep the test speed from disengaging, disconnect the speed sensor from the system.*

Distance

The distance value can be used as an odometer of the distance traveled by a vehicle over a season, or the distance traveled during one application. Touch the Reset Value button to clear the distance value, or allow the field computer to keep a running tally of the total distance traveled.

Valve

Touch the Valve button to access the Valve Calibration screen.

Standard/Fast/Fast Close

PWM/PWM Close

The screenshot shows the 'Valve Calibration' screen with the following elements:

- Valve Type:** Radio buttons for Standard (selected), Fast, Fast Close, PWM, and PWM Close.
- Valve Cal (2123):** A text field with a blue background and a 'PROD 1 2' icon to its right.
- Valve Cal 2 (0):** A text field with a blue background.
- Advance (5):** A text field with a blue background.
- Reset Valve Cal:** A button with a blue background.
- Navigation:** A green checkmark icon and a grey 'X' icon in the bottom right corner.

The screenshot shows the 'Valve Calibration' screen with the following elements:

- Valve Type:** Radio buttons for Standard, Fast, Fast Close, PWM (selected), and PWM Close.
- Valve Cal (43):** A text field with a blue background and a 'PROD 1 2' icon to its right.
- Valve Cal 2 (0):** A text field with a blue background.
- Modify PWM Settings:** A button with a blue background.
- Reset Valve Cal:** A button with a blue background.
- Navigation:** A green checkmark icon and a grey 'X' icon in the bottom right corner.

Valve Type

Select the type of control valve used to control the selected product during a job.

Note: If 'PWM' or 'PWM Close' is selected as the valve type, a button labeled 'Modify PWM Settings' will be displayed on the calibration screen.

Valve Cal

Note: If the dual loop control feature is enabled, the valve cal value will be replaced by the flow cal value.

The valve cal value helps the field computer adjust the valve control response for slight differences between control valves and is required for product control. Raven Industries recommends the following calibration values for initial system setup.

| Control Valve Type | Valve Cal |
|---------------------------------|-----------|
| Standard (C-SD) | 2123 |
| Fast (C-F) or Fast Close (C-FC) | 743 |
| PWM (C-P) or PWM Close (C-PC) | 43 |

These values are good starting points and will generally yield adequate results, however, the valve cal should be refined for the individual control valves installed on the specific machine. See *Valve Cal* section on page 194, for information on the components of the valve cal setting or on tuning the valve cal value.

Flow Cal (Dual Loop Control Mode Only)

The flow cal value may be used when controlling a liquid application system using a PWM control valve. This value sets how the system responds to rate control inputs while product is flowing through the flow meter. A value between 11 and 999 may be entered for the flow cal value. The default value for the flow cal is 103.

Refer to the *Flow Cal (Dual Loop Control Mode)* section on page 195 for information on the components of the flow cal setting or on refining the flow cal value.

Note: *Set the Sgain value prior to adjusting the flow cal value.*

When adjusting the flow cal value, it is not recommended to adjust the last digit (i.e. '3' in the default value). Review the Flow Cal (Dual Loop Control Mode) section on page 195 for more information.

Valve Cal 2

Note: *If the dual loop control feature is enabled the valve cal 2 value will be replaced by the Sgain value.*

This value can fine tune control valve response and help control application rate oscillations when the console is programmed in PWM mode.

When a fast close valve is selected, the valve cal 2 value is utilized to enable a high resolution rate control for lower application rates. Enter a non-zero value for the time, in milliseconds, which the valve will be fully opened before switching into high resolution control. For example, a value of 200 will give the valve a 200 millisecond "burst" at a full 12 V to open the fast valve from the closed position before resuming product rate control. A zero value will disable this feature.

Sgain (Pressure System Gain - Dual Loop Control Mode Only)

The Sgain value may be used when controlling a liquid application system using a PWM control valve. Use this value to adjust how aggressively the application system responds to pressure changes in the application system. The default setting for the Sgain value is 100. To adjust the system aggressiveness, enter a value between 1 and 999 as necessary.

Note: *It is recommended to increase or decrease the current value in increments of 10 or less when making adjustments to the Sgain setting. If the new value does not produce significant or notable changes in the system response, increments of 20 may be used.*

For example, increase the Sgain value if the observed product pressure increases too slowly or if the system takes a long time to reach a set standby pressure or rate input change. If the system is consistently overshooting a set standby pressure or oscillating around a target rate, decrease the Sgain value until the system stabilizes.

Standby Pressure Sgain. The standby pressure feature may be enabled in either the standard or dual loop control modes. When enabled in the standard control mode, the Sgain value is not displayed on the Valve Calibration screen, but is still used to set the response of the system to the application system pressures.

Note: *Refer to the Feature Settings section on page 114 for information about enabling the standby pressure feature on the Feature Settings screen.*

To access and set the Sgain value while operating in the standard control mode:

1. From the field computer Home screen, select the Tools Menu icon.
2. Select the Product Control icon from the System menu.

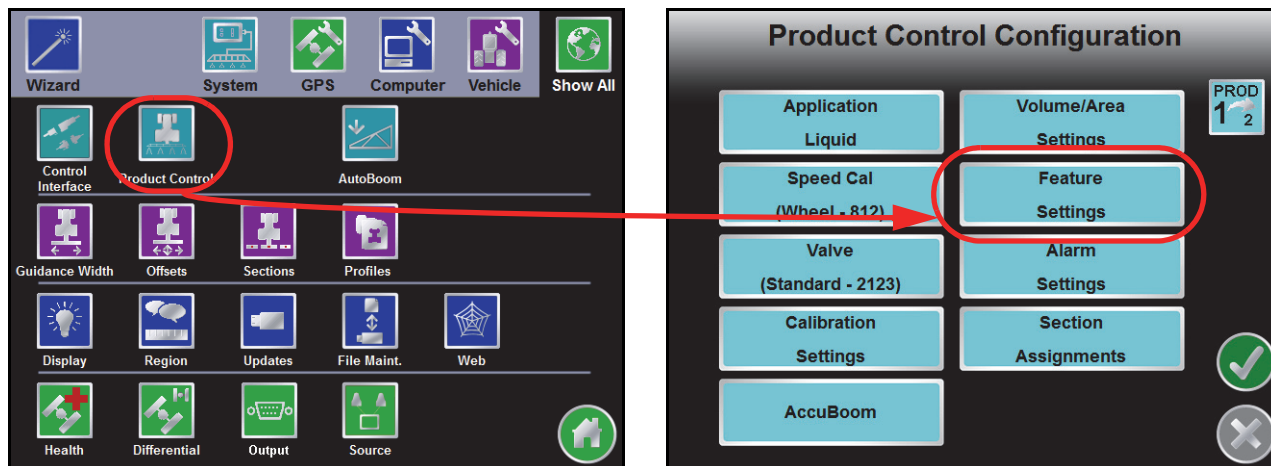

3. Touch the Feature Settings button.
4. On the Feature Settings screen, touch the dual loop control option to enable the feature and select the Accept icon to return to the Product Control Configuration screen.

Note: Refer to the Feature Settings section on page 114 for additional information about the settings and features available on this screen.

5. Select the Valve button on the Product Control Configuration screen and touch the Sgain button.
6. Use the on-screen keypad to enter the desired Sgain value and touch the Accept icon to save the new value.
 - a. Increase the Sgain value if the product pressure takes too long or cannot reach the set standby pressure.
 - b. Decrease the Sgain value if the product pressure overshoots or oscillates around the set standby pressure.
7. Return to the Feature Settings screen and disable the dual loop control feature before resuming product application in the standard control mode.

Valve Advance (Standard or Fast Valve)

This feature allows the operator to set the amount of time (in seconds) which the control valve will remain open after boom sections are toggled off while in automatic rate control mode. A value of 1-9 means an advance of 1-9 seconds respectively. A value of 0 means no advance. This setting may be used in conjunction with the valve delay for low rate applications to build up pressure when the master switch is toggled on. For best results, approach the headlands at consistent speeds while turning boom sections off.

Note: This feature is useful when controlling flow back style boom on/off valves. The Advance button is only displayed if a Standard, Fast, or Fast Close valve is selected and if the assigned product control node has software version 1.50 or higher. When operating with a fast close valve, a value of zero is recommended for the valve advance feature.

Reset Valve Cal

Touch the Reset Valve Cal button to replace the current valve cal with the recommended value from the table shown above.

Modify PWM Settings (PWM or PWM Close Valve)

If either 'PWM' or 'PWM Close' is selected as the valve type, a Modify PWM Settings button will display.

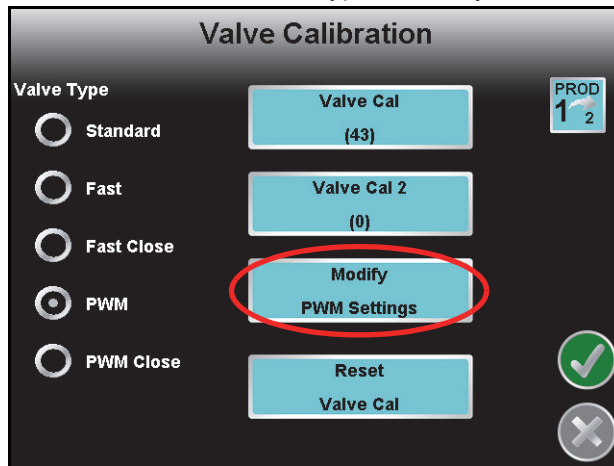

Select one of the following methods to configure the PWM control valve associated with the selected node or control channel.

Manual Calibration. The manual calibration mode allows the operator to manually enter the PWM minimum, maximum and preset values to known values using an on-screen keypad.

Note: *The PWM valve is not operated in the manual calibration mode. It is recommended to verify that any changes to these settings have the desired affect before controlling product application.*

Refer to the PWM Calibration Screen section on page 107 for more information on the PWM values configured using the manual calibration mode.

Calibration Assistant. The calibration assistant allows the operator to increase or decrease the PWM output using on-screen controls and set the PWM minimum, maximum, frequency and preset values based upon observed operation.



WARNING

The PWM valve output will increase and decrease as the up and down arrows are selected. Keep any bystanders away from areas where product may be expelled and moving components when performing the calibration process.

To use the calibration assistant mode, toggle the vehicle master switch and at least one section to the on position. To stop PWM output at any time during the calibration process, toggle the vehicle master switch to the off position.

Note: *Refer to the PWM Calibration Screen section on page 107 for more information on the PWM values configured using the calibration assistant.*

Automatic Calibration. The automatic calibration mode will allow the field computer to automatically adjust the PWM output and attempt to determine the minimum, maximum and preset values.

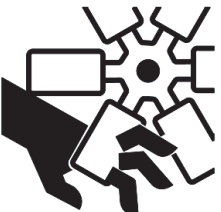

WARNING

The PWM valve output will increase and decrease during the calibration procedure. Keep away from areas where product may be expelled and moving components and alert anyone around the equipment when performing the calibration process.

To use the automatic assistant mode, toggle the vehicle master switch and at least one section to the on position. Touch the 'Cancel' button at any time during the calibration to stop PWM output.

The automatic calibration process may take up to two minutes to complete. Maintain sufficient engine RPM and set the remote hydraulic flow to allow for at least 1 GPM [3.8 L/min] flow for each motor on the control system. The field computer will display a prompt when the calibration process is complete. If the system fails to calibrate properly, touch the 'Re-calibrate' button to restart the calibration process.

PWM Calibration Screen

In the manual calibration and calibration assistant modes, the PWM Calibration screen will display with the following options or settings available.

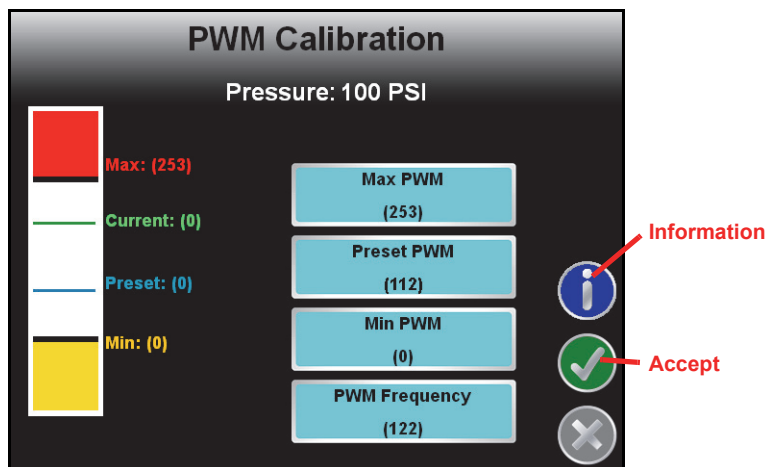

Information. Touch the blue Information icon to display a brief explanation of the settings and options available on the PWM Calibration screen.

Max PWM. Enter a Max PWM value to set the maximum desired RPM or hydraulic output for a Pulse Width Modulated (PWM) hydraulic control valve. This setting limits how far the PWM valve will open.

With the master switch in the on position, increase this value until one of the following conditions is met:

- The maximum desired flow is reached in a liquid system
- The maximum desired belt speed is achieved in a granular system

Preset PWM. When operating with a PWM valve, the preset PWM value sets how far the valve will stay open to maintain pressure in the system. When the master switch is off, the PWM pulse width will remain at the existing value or go to the preset PWM value, whichever is lower.

When operating with a PWM close valve, the preset PWM setting is the initial target pulse width when the master switch is turned on. If this value is set to zero, the pulse width will return to the last value when the master switch is turned on.

Note: *If the Standby Pressure feature is enabled on the Feature Settings screen, the preset PWM value will be replaced by the standby pressure value. Review the Feature Settings section on page 114 for more information on the Standby Pressure feature or see the Standby Pressure section on page 108 for more information on setting the standby pressure value.*

Standby Pressure. When controlling a liquid product with a PWM valve selected (not PWM close), the standby pressure value sets the pressure which the system will maintain in the product lines when the master or all boom sections are toggled off.

Note: *The standby pressure setting is only accessible when controlling products in liquid control modes with a boom pressure transducer detected by the field computer. Refer to the Feature Settings section on page 114 for details.*

If the system pressure does not reach the set standby pressure, or if the observed pressure oscillates, when the master switch is toggled off, the Sgain value will need to be adjusted. See the Sgain (Pressure System Gain - Dual Loop Control Mode Only) section on page 104 to adjust the Sgain value.

Min PWM. Enter a Min PWM value to set the minimum desired RPM or hydraulic output (zero point or shutoff point) for a Pulse Width Modulated (PWM) hydraulic control valve.

With the master switch in the on position, decrease this value until one of the following conditions is met:

- The minimum desired flow is reached in a liquid system
- The value when the belt stops moving in a granular system

PWM Frequency. This value sets the frequency of the pulses that are sent to the PWM valve. The default value is 122 Hz for Raven valves, or a value specified by the valve manufacturer.

Calibration Settings

The Calibration Settings screen displays calibration values for the selected product and application type.

Liquid Control Mode

Granular Control Mode

Touch the corresponding button to enter or modify a calibration value for the selected product node.

Note: For recommended methods of calculating various calibration values, refer to Appendix A, *Calculating the Calibration Values*.

If the field computer is connected to the optional Raven OmniSeed system for seeder control operations, refer to Appendix I, *OmniSeed™ Calibration*, for details on settings used with the OmniSeed feature.

Meter Cal, Spinner Cal, or Product Density

- The flow meter calibration (meter cal) value can be found on the tag attached to the flow meter. Review the *Meter Cal* section on page 191

Note: Copy the information from the tag for future reference as tags may fade or be lost during operation.

- If operating in a granular application mode, the Product Density button replaces the meter cal value. Touch the Product Density button to enter the measured product density.
- When controlling the spinner RPM with granular product applications, the spinner calibration setting will replace the meter cal setting on the Calibration Settings screen.

Rate Cal

Enter the target rate for the product controlled by the selected product node. Consult with a dealer to ensure spray nozzles or gate height of the machine is capable of applying at the target application rate for the product being applied. See Appendix A, *Calculating the Calibration Values*, for more information on calculating the rate cal.

Verifying Flow Rate Limits. The target rate for an application must be within the range of that specified for the Raven flow meter installed.

| Flow Meter Model | Flow Range | Average Meter Cal Value |
|-------------------|------------------------------------|-------------------------|
| RFM 5 | 0.05 - 5 GPM [0.2 - 18.9 lit/min] | 5500 |
| RFM 15 | 0.3 - 15 GPM [1.1 - 56.8 lit/min] | 1750 |
| RFM 60P | 1 - 60 GPM [3.8 - 210 lit/min] | 720 |
| RFM 100 | 3 - 100 GPM [11.4 - 380 lit/min] | 700 |
| RFM 200/ 200 Poly | 15 - 200 GPM [56.8 - 760 lit/min] | 164 |
| RFM 400 | 25 - 400 GPM [94.6 - 1515 lit/min] | 80 |

Valve Delay

Use the valve delay option to include a delay in seconds between turning on the control valve (turning on sections) and when the product control nodes begin to control the flow rate.

Note: *A value of zero must be entered when using a close-type valve, such as a Fast Close or PWM Close valve. A zero value must also be entered when programming a standard valve with an injection system.*

Pump or Fan Cal

The pump or fan cal is used to calibrate the field computer to the specific fan (granular) or pump (liquid) on the machine. Enter the number of pulses sensed per one revolution of the fan or pump. These values are for monitoring purposes only. The field computer will not control based upon these calibration values or the monitored RPM of the pump or fan.

Tiered Boom Settings

A tiered boom configuration has two or more booms stacked one directly in front of the other and may or may not have different sets of nozzles capable of applying different rates.

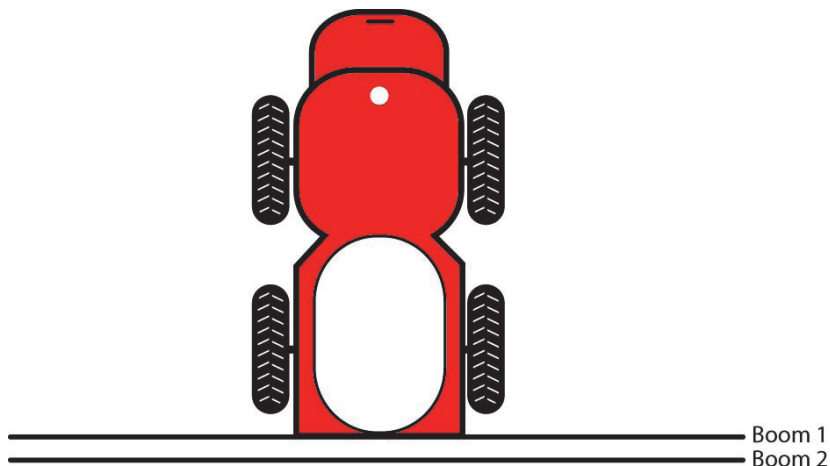

Note: *Specialized plumbing, cabling and a relay box are required to utilize a tiered boom configuration. Generally, sprayers are not setup for this feature from the factory.*

Refer to the *Tiered Boom Settings* section on page 197 for more information on calculating the tiered boom settings.

Spreader Constant (Granular Systems)

The field computer uses the programmed spreader constant to accurately control granular products. To maintain system accuracy, re-calibrate the spreader constant anytime the gate height of the machine is adjusted. Refer to Appendix A, *Calculating the Calibration Values*, for assistance calculating the spreader constant.

Rate Bump

The rate bump value sets the increment by which the target rate will increase or decrease when using the Rate Bump buttons on the Guidance screen. Each product node or control channel must be programmed with the desired rate bump value. If no value, or a value of zero, is entered the rate bump buttons will have no effect on the selected product application rate on the Guidance screen.

Pressure 1 and 2 Cal

For each product node connected to the CANbus, the field monitor can monitor and display up to two pressure readings.

Touch the Pressure 1 or Pressure 2 buttons to enter the pressure cal for each pressure transducer. With no pressure in the machine product lines, enter a pressure cal of '0' to calibrate the pressure display.

Prescription (Rx) Settings

If an optional variable rate application (VRA) key has been activated, the Rx Settings button will be displayed on the Calibration Settings screen.

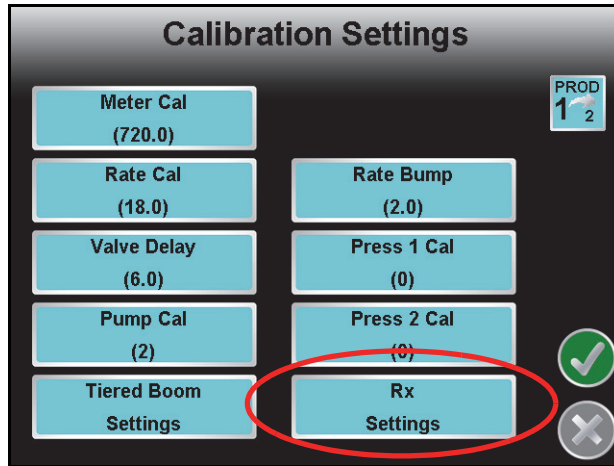

Touch the Rx Settings button to display the Rx Settings screen.

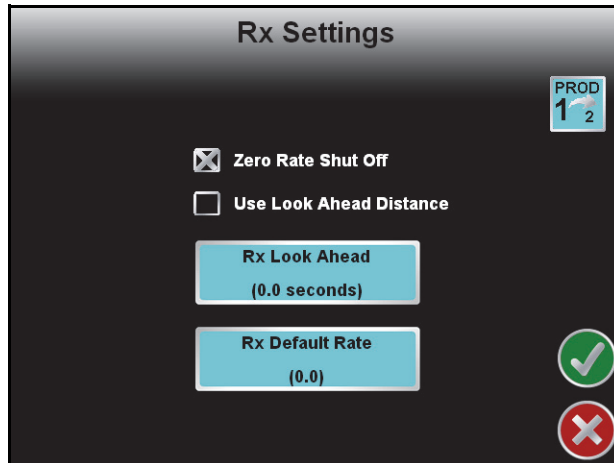

Zero Rate Shut Off. Enable the Zero Rate Shut Off option to allow the field computer to close product control valves based on zones with a target rate of zero on the prescription map. Refer to Chapter 8, *Software Updates and File Maintenance*, for more information on transferring prescription maps.

Note: *Enabling the Zero Rate Shut Off feature will affect all control channels.*

Prescription (Rx) Look Ahead Distance. Enable the 'Use Look Ahead Distance' option on the Rx Settings screen to set look-ahead values in units of distance rather than time for changing the prescription map rate control zones.

Note: *The vehicle must travel at a constant speed while using the look ahead distance.*

Enabling the look ahead distance option will affect all control channels.

Prescription (Rx) Look Ahead. Set the Rx Look Ahead setting to the number of seconds (determined by speed) the field computer is allowed to scan in front of the current vehicle position. This feature may help to compensate for the time it takes a valve to adjust to a different rate or to fully open or close.

Prescription (Rx) Default Rate. Set the Rx Default Rate at the Target rate for areas without Prescription information. The field computer will apply the default rate within any areas of a prescription map without a rate. Product control in Zero Rate zones will remain at zero. The Default Rate only affects areas where prescription rate information has not been entered.

AccuBoom

If the optional AccuBoom, automatic boom section control, feature is detected by the field computer, the AccuBoom button will be displayed on the Product Control Configuration screen.

Settings for the optional AccuBoom, automatic boom section control, feature are available for each product controlled with the field computer. Refer to the *AccuBoom™ Setup* section on page 164 for more information on configuring the AccuBoom feature for liquid or granular product application control.

Note: Refer to the *AccuRow or OmniRow Calibration and Operation Manual* for additional information on configuring the optional AccuRow, automatic planter section control, feature when controlling planter systems.

Volume and Area Settings

The volume/area Settings screen allows the operator to program the tank or bin volume for the machine, the field volume, total volume, field area and total area.

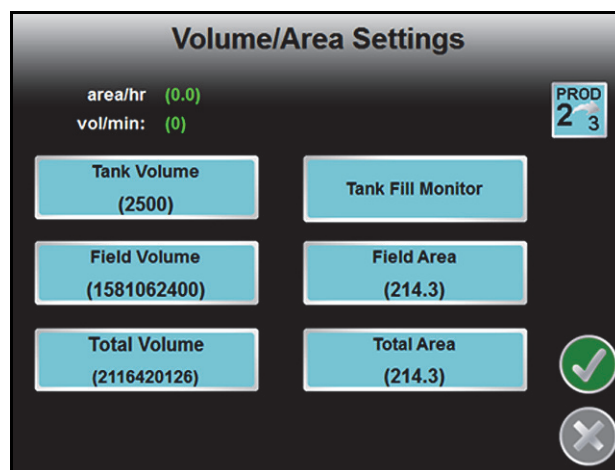

Tank Volume or Bin Level

The tank or bin indicator on the Guidance screen displays a tally of product remaining based upon this value. The tank or bin volume is the volume of product in, not the capacity of, the tank or bin. Set this value to the normal volume of product in a full tank or bin. This setting also determines the value of the 'Reset Tank or Bin Volume' button.

Refer to the *Entering Tank Volume or Bin Level* section on page 202 for information on setting the tank volume or bin level.

Tank Fill Monitor

If an optional tank fill monitor system is installed with the field computer, the Tank Fill Monitor button will be displayed on the Volume/Area Settings screen. Touch this button to access the tank fill system while refilling the product tanks. Refer to Appendix G, *Tank Fill Monitor Calibration* for additional information on using the Tank Fill Monitor.

Field Volume and Area

The field volume and field area displays on the Volume/Area screen can be reset independently of the total volume and total area displays. Reset the field volume and field area to keep a record of the volume of product applied to a field and the acres applied in that field.

Total Volume and Area

The total volume and total area displays on the Volume/Area screen can be reset independently of the field volume and field area displays. For example, reset the total volume and total area to keep records of the total volume of product applied and the total acreage covered.

Feature Settings

From the Home screen, touch the Tools Menu icon and select the Product Control icon from the System menu. Touch the Feature Settings icon to configure additional features settings on the field computer. The Feature Settings screen may display the following options:

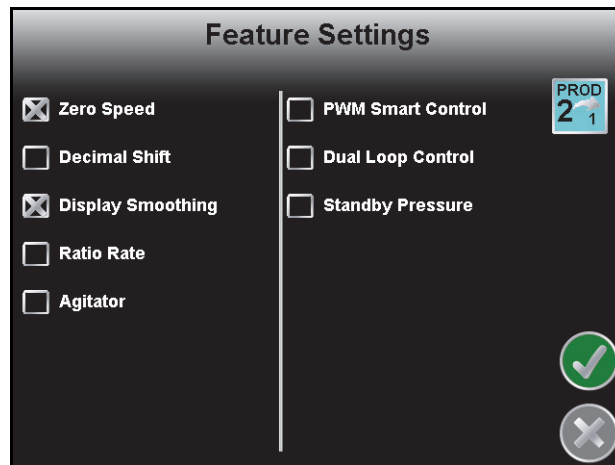

Zero Speed

The zero speed feature will automatically turn off product application if the vehicle speed drops below 0.7 mph [1.1 km/h] while in automatic mode. To restart the system, cycle the master switch 'Off' then back 'On.' A speed of 0.7 mph [1.1 km/h] must be maintained for more than 10 seconds or the zero speed feature will reactivate.

Decimal Shift

Use the decimal shift feature to increase the system accuracy for low application rates. In the standard mode, the field computer displays values to one decimal place. With decimal shift mode active, the field computer displays values to two decimal places.

Note: *If the decimal shift feature is changed, be sure to verify all calibration settings to ensure accuracy of the product control system. Change settings as necessary.*

Display Smoothing

Toggle the display smoothing feature to allow the field computer to smooth the rate display on the Guidance screen. With the feature selected, as long as the actual rate is within 10% of the actual application rate, the target rate will display as the actual rate on the Guidance screen. The actual rate will be displayed if the actual rate does not reach the target rate dead band ($\pm 10\%$) within 10 seconds.

Ratio Rate

The ratio rate feature configures the selected control channel to apply an injected chemical at a rate proportional to the carrier product flow rate. The ratio rate application mode must be enabled via the control console and a ratio rate cal value must be entered for each product controlled in ratio to the carrier.

Note: *The carrier product must be programmed on control channel 1. If a carrier product is not set as product 1, the low pressure alarm will not function. If the off rate alarm is triggered frequently during injection applications in ratio rate mode, access the volume per minute display on the control console and verify that the target flow rate is within the application range for the pump.*

The ratio rate calibration value is entered as the ratio of injected chemical to carrier in ounces per gallon [deciliters per liter].

For Example:

If the desired ratio of injected chemical concentration is 2 ounces per gallon [0.59 deciliters per liter], enter a value of 2 [0.59] for the ratio rate cal value. Once the operation conditions in the Normal Application Mode section on page 29 are set, the system will automatically adjust the rate of injected product in proportion with the carrier product flow rate.

Agitator

If equipped with an injection system featuring an agitator enabled output, this option enables or disables a chemical agitator.

PWM Smart Control

The PWM smart control feature may be enabled to allow the control system to estimate the required PWM duty cycle for changes in vehicle speed or target rate, or when the hydraulic valve is toggled on. When this feature is enabled, control response will be much more aggressive.

Note: *Smart control will be tuned during the PWM calibration. Refer to the Modify PWM Settings (PWM or PWM Close Valve) section on page 106 for additional information on performing calibration or adjustments for PWM type control valves.*

Dual Loop Control

The dual loop control feature is designed for use with low application rates and requires a pressure transducer with a liquid application system controlled with a PWM valve. The dual loop feature uses both the flow meter to monitor liquid product flow and a pressure transducer to monitor liquid product pressure controlling a pump to enhance the control response during operation at low application rates. The default setting for this feature is disabled.

If the dual loop control feature is enabled, the valve cal and valve cal 2 values programmed during the initial field computer configuration will be replaced with the flow cal and Sgain values.

Standby Pressure (PWM Valves Only)

The standby pressure enable selection allows the operator to toggle the standby pressure feature on or off and enter a minimum pressure to maintain when all section or the master switch is turned off. Refer to the *Preset PWM* section on page 108 for information on the standby pressure value.

Note: *To enable the standby pressure feature, the product control system must have a PWM valve controlling a liquid application system and a pressure transducer connected to the control node. If these requirements are not met, the console will automatically disable the standby pressure feature. When enabled, the standby pressure setting will replace the 'Preset PWM' setting on the Valve Calibration screen. Review the Preset PWM section on page 108.*

Alarm Settings

From the Home screen, touch the Tools Menu icon and select the Planter icon from the System menu. Touch the Alarm Settings button from the Planter Control screen to display the Alarm Settings screen. The Alarm Settings screen is used to set the values at which the field computer will display visual alarms on-screen. The Alarm Settings screen also allows the operator to enable an audible alarm tone when the visual alarm notice displays.

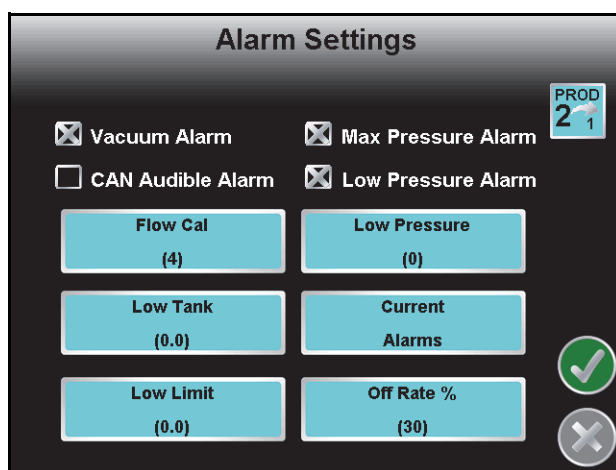

Note: *Some alarm settings or features may be available only in specific control modes or when the field computer detects specific components or features on the CANbus.*

Bin Alarm

In any of the granular modes, a bin alarm option is displayed on the Alarm Settings screen. Enable the Bin Alarm if a bin level sensor is connected to the control system. When the sensor detects a low level in the bin, the field computer displays the alarms window to alert the operator of the condition.

Vacuum Alarm

The vacuum alarm is available when a CAN motor control or injection node is detected on the CANbus. Enable this alarm to display an alert if the injection system begins running in a vacuum state.

CAN Audible Alarm

Select the CAN Audible Alarm to enable the audible alarm tone for the configured settings on this screen. If any of the following settings are encountered, the field computer plays an audible tone to warn the operator of the condition.

Flow Error Cal (CAN Motor Control)

If a CAN motor control node for an injection pump is connected to the CANbus, the Alarm Settings screen will display the Flow Cal alarm feature. This alarm may be used to indicate that the chemical tank is empty or the pump is unable to prime or inject product.

Enter a value between 0 and 100 for the percentage of error allowed between the flow switch and pump encoder before a flow alarm will be displayed. For example, set this value to 100 to disable the flow error cal alarm or 0 to display an error any time the flow switch and pump encoder do not match. The default value for the flow error cal alarm is 50.

Note: *The Flow Error Cal is replaced with the FER (Flow to Encoder Ratio) value when operating a Raven Sidekick Pro™. Refer to the Sidekick Pro Installation and Operation Manual for more information about operation with the Envizio Pro field computers.*

NH3 Configuration

Note: *The NH3 configuration value will only be available when the field computer is configured for interfacing with a Raven anhydrous ammonia control system such as AccuFlow™ or AccuFlow HP™ Plus. Refer to Application Type section on page 100 for additional assistance with the application type settings.*

Enter the following values to set the system features available with the AccuFlow system:

| Value | Remote Proximity Sensor | Section Feedback |
|-------------|-------------------------|------------------|
| 3 | Enabled | Disabled |
| 4 | Disabled | Disabled |
| 5 | Enabled | Enabled |
| 6 (Default) | Disabled | Enabled |

Dual Flow (%) Percent

When controlling a dual bed system in Gran 3 mode, the Dual Flow Percent feature may be set up on the Alarm Settings screen. Set the dual flow percent alarm for the tolerance between belt encoder readings before the field computer will display an alarm condition. This alarm may be used to indicate that the belts are traveling at different rates or one belt is not moving. The out of tolerance condition must be met for at least 5 seconds before the alarm is displayed.

Enter a value of 100 to disable the dual flow percent alarm or 0 to display an error any time the belt encoders do not match. The default value for the dual flow percent alarm is 50.

Low Pressure

The Low Pressure setting is only displayed on the Alarm Settings screen when a pressure transducer is connected to the system and detected by the field computer.

Enter the minimum desired pressure in PSI [kPa] for product at the pressure transducer location. If the product pressure falls below the programmed, the field computer will display an alert.

Note: *The product control valve will stop closing when the Low Pressure setting is reached.*

Low Tank or Bin

Enter the tank or bin volume at which alarms area will activate indicating that a product is running low.

Low Limit

The Low Limit value sets the minimum volume per minute which a product will be applied. If the flow meter drops below this setting, the field computer will display an alert.

Note: *The product control valve will stop closing when the Low Limit setting is reached.*

Low Supply Alarm

Note: *The low supply alarm value will only be available if the control channel is configured for AccuFlow HP+ system control. Refer to Application Type section on page 100 for additional assistance with the application type settings.*

The low supply alarm value configures the minimum acceptable pressure in PSI [kPa] of the anhydrous ammonia within the cooler. If the pressure falls below the entered value, the system will display an alert. Set the low supply pressure between 0 to 50 PSI [0 to 345 kPa]. Enter a value of zero to disable the low supply alarm.

Max Pressure Alarm

Note: The low supply alarm value will only be available if the control channel is configured for AccuFlow HP+ system control. Refer to Application Type section on page 100 for additional assistance with the application type settings.

Enter the maximum pump pressure in PSI allowed for the AccuFlow HP™ Plus system. If the pressure monitored on the pump outlet rises above the configured value, the field computer will trigger an alert for the operator. The field computer will provide an operator alert if the system pressure reaches the configured value during anhydrous ammonia applications. The pressure alarm may be set between 0 to 250 PSI [0 to 1724 kPa]. Enter a value of zero to disable the maximum pressure alarm condition.

Off Rate Percent

Enter the percentage at which the Off Rate alarm will activate. The Off Rate alarm activates when the actual rate differs from the target rate by the programmed value for longer than five seconds.

The off rate alarm percent value will also determine the coverage mapping colors during an active job.

Current Alarms

Touch the Current Alarms button to display any current product alarms.

Section Assignments

The Section Assignment screen allows the operator to assign products to a section. Place a green check mark below a section to assign the selected product to that section.

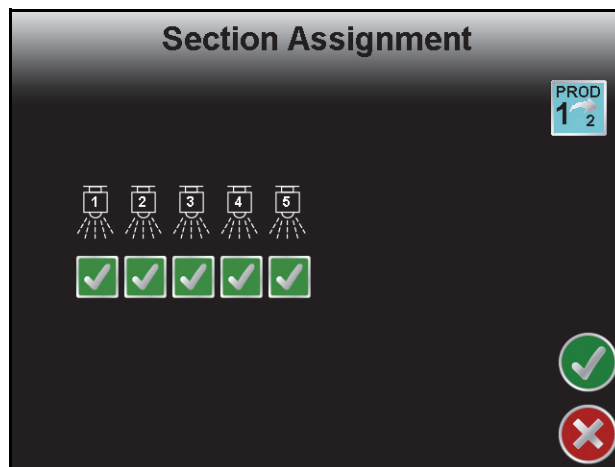

Note: The vehicle or implement's plumbing must accommodate the selected section assignments.

AutoBoom®

Touch this icon to display the AutoBoom Setup screen. See Chapter 10, *Using AutoBoom®*, for a brief overview of this feature on the Envizio Pro. Refer to the AutoBoom Calibration & Operation Manual for calibration and detailed operation instructions.

Note: *If no AutoBoom node is detected by the CANbus, a Function Disabled screen will appear. Troubleshoot the node and readdress the CANbus. See Chapter 4, CAN Networking and Diagnostics, for CAN installation and troubleshooting information.*

Steering

If an optional assisted steering system has been installed, the Steering icon will be displayed in the System menu. Touch this icon to access the Steering Settings screen. For more detailed installation and calibration Information, refer to the *SmarTrax Calibration and Operation Manual*.

GPS Menu

The GPS menu displays available options for the DGPS source. The GPS menu contains the DGPS Source selection options as well as settings for Message Outputs, Differential Sources, and a DGPS Status, or Health, screen.

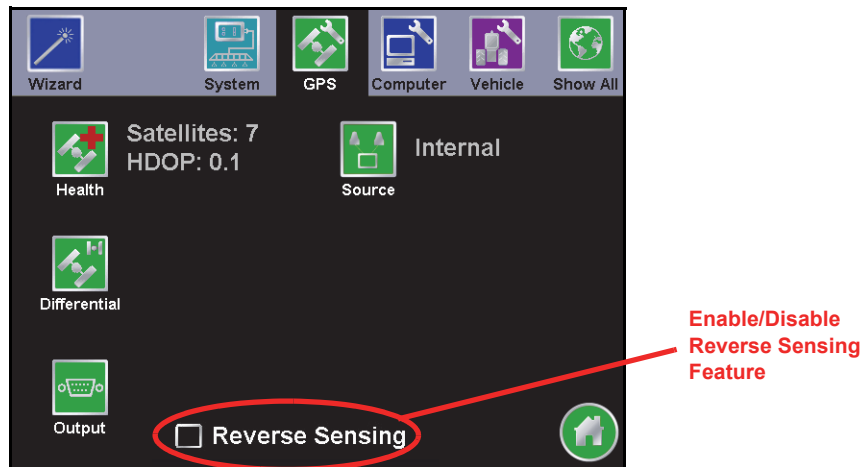

Note: *The Source and Output screens are only available on consoles featuring the built-in receiver. These screens are only accessible if the built-in receiver is selected as the source of DGPS signal.*

Reverse Sensing

Select this option to allow the field computer to automatically detect when the vehicle is traveling in reverse. When reverse speed is detected, the field computer will keep the previous orientation of vehicle indicator while updating the vehicle position.

Note: *If this feature is disabled, the guidance display will assume all vehicle motion is in the forward direction.*

Touch the 'Reverse Sensing' option at the bottom of the GPS Menu screen to toggle the reverse sensing feature. It is recommended to enable this feature if the field computer must accurately map application or field coverage while the vehicle is reversing (i.e. backing into corners).

Note: *When the reverse sensing feature is enabled, the field computer may occasionally require the operator to manually override the current direction of travel during field operations. Review the GPS Health section on page 122 and the Direction of Travel Indicator section on page 124 before starting a job to ensure that the operator can toggle the direction of travel if necessary.*

The reverse sensing feature is not displayed if a SmarTrax terrain compensation node is connected to the field computer.

The direction of travel icon (shown to the right) will be displayed on the Guidance screen any time the field computer detects that the vehicle is traveling in reverse. Touch the reverse direction icon to manually toggle the direction of travel displayed on the Guidance screen.



If the reverse direction icon is not displayed on the Guidance screen, touch the GPS Status Indicator and touch the direction of travel icon along the right side of the screen to manually toggle the displayed vehicle course.

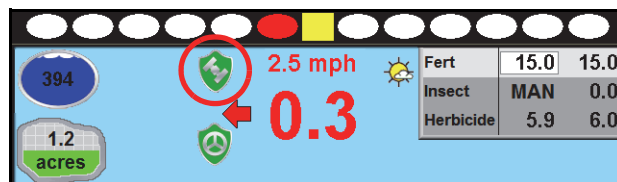

GPS Health

The GPS Health screen displays the status of GPS reception and can be used to troubleshoot the DGPS receiver and signal.

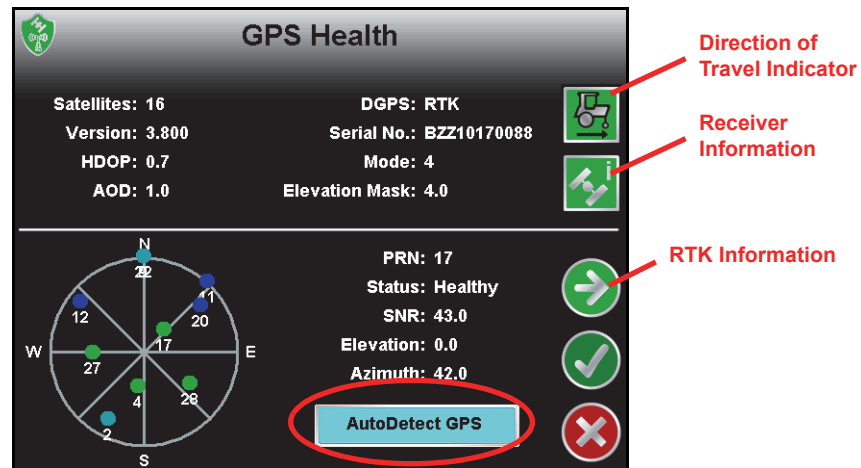

Note: The GPS Health screen is quickly accessible from the Home screen or from the Guidance screens by touching the GPS Status icon.



The RTK Information screen accessible by touching the Next on the GPS Health screen will only be available if the field computer is configured for RTK corrections.

GPS Status Display Information

The upper portion of the GPS Health screen displays the following information:

Satellites. Number of satellites locked onto and used to determine correction. The field computer requires a minimum of 5 satellites to provide differential correction.

DGPS. Displays the source of differential correction being used.

Note: If using the e-Dif correction source with the Envizio Pro internal receiver, the DGPS field will display AUTO.

Version. The firmware version of the DGPS receiver. This information may not be available in all configurations or with some third party receivers.

Serial Number. The serial number of the DGPS receiver. This information may not be available in all configurations or with some third party receivers.

HDOP. The Horizontal Dilution of Precision must be below 2.0 to maintain differential. If HDOP exceeds 2.0, the GPS Status shield will change to yellow to alert the operator of the DGPS condition.

Mode. Displays the current differential fix status. The mode value will display:

- '0' or '1' if no differential corrections are being received
- '2' when the DGPS receiver is converging GS correction services, or the receiver has locked onto a differential source when using SBAS
- '4' for RTK fixed mode for fine GPS course correction mode
- '5' for RTK float mode for coarse GPS correction mode, or a converged status when using OmniSTAR XP/HP or GS correction services.

Note: Refer to the *RTK Fixed and Float Modes* section on page 52 for more information on RTK fixed and float modes.

AOD. The Age of Data corrections is shown in seconds. This is the time since the last GPS message update has been received.

Note: A Raven assisted steering system will disengage after a few seconds without a GPS message update.

Elevation Mask. The elevation mask sets the minimum elevation of a satellite above the horizon which the field computer may use for differential correction. This value is displayed in degrees above horizontal.

Refer to the *Elevation Mask* section on page 125 to modify the elevation mask setting.

The lower portion of the GPS Health screen displays the following satellite constellation information:

Satellite Constellation Map. The field computer displays the constellation of satellites currently locked and used to determine differential. Touch a satellite displayed in the constellation to display information about each satellite in the constellation.

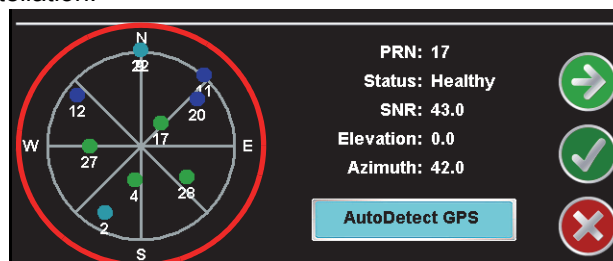

Note: To view the satellite constellation, be sure to set the GSA message to 1 Hz from an external DGPS receiver.

If a Raven automatic steering system is connected, the satellite constellation and individual satellite information may not be available on the GPS Health screen.

The satellites being tracked by the field computer will display green in the constellation map if the signal to noise ratio (SNR) value is 42 or higher. Satellites displayed as blue have an SNR value between 30 and 41 while satellites with an SNR below 30 will display as light blue.

PRN. Displays the PRN for the satellite currently selected in the constellation map area.

Status. The signal status of the selected satellite is displayed in this field. Satellites with a Signal to Noise Ratio (SNR) at 40 or above will display a Healthy status and appear green in the satellite constellation map while an SNR below 40 will show an Unhealthy status and appear blue in the map.

SNR. Displays the Signal to Noise Ratio of the selected satellite. To maintain differential signal, at least two satellites in the constellation must have a Signal to Noise Ratio higher than 50.

Elevation. This value represents the elevation of the satellite and is displayed as degrees above the horizon.

Azimuth. The azimuth, or bearing, of the satellite is displayed as degrees from due North.

Direction of Travel Indicator

This indicator displays the last direction of travel detected by the field computer. Touch the indicator to toggle the direction of travel manually if the indicator or map display is incorrect.

Note: *When operating with an optional Raven SmarTrax™, assisted steering system, the direction of travel icon may not be displayed in this location if the terrain compensation feature is enabled. Review the SmarTrax Calibration and Operation Manual for details on using these systems with the Envizio Pro field computers.*

Receiver Information

Touch the this icon to access details about the GPS receiver such as serial number, firmware version, receiver model, and the type of GPS receiver on-board the field computer.

This information will be required when unlocking additional features of the GPS receiver or when activating GS Satellite corrections.

AutoDetect GPS

Touch the 'AutoDetect GPS' button on the GPS Health screen to allow the Envizio Pro to attempt to automatically detect GPS information coming from an external device. The autodetect feature is normally only required when interfacing with an external receiver or when receiving GPS information back from a SmarTrax or TM-1 Tilt Module.

RTK Information Screen

When using the internal GPS receiver, or a compatible external GPS receiver such as the Raven Phoenix 300, in RTK mode, touch the 'Next' icon on the GPS Health screen to view RTK base station information such as the base station I.D. and baseline distance. This information may be used to help troubleshoot issues with the system if necessary.

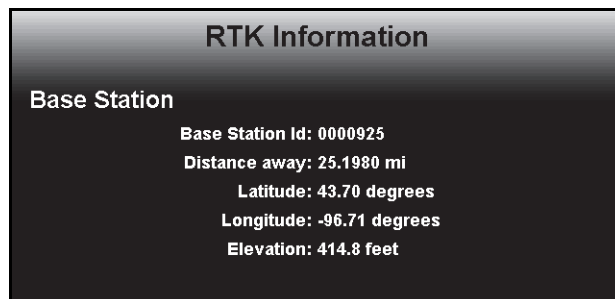

Differential

Important: If a SmarTrax assisted steering system is connected to the Envizio Pro field computer, set the correction source to internal before making changes to the Envizio Pro internal receiver.

Note: If the Envizio Pro is not able to detect the source or type of differential corrections received from the an external GPS receiver, or if corrections are routed from the internal GPS receiver through a Raven SmarTrax system or TM-1 Tilt Module, the Differential screen will be replaced by the Default Differential screen. Refer to the Default Differential section on page 131 for more information on using the differential settings displayed on this screen.

Select the Differential icon from the GPS menu to set up the internal receiver for the desired GPS correction source. Generally, the SBAS (WAAS/EGNOS) option is selected by default.

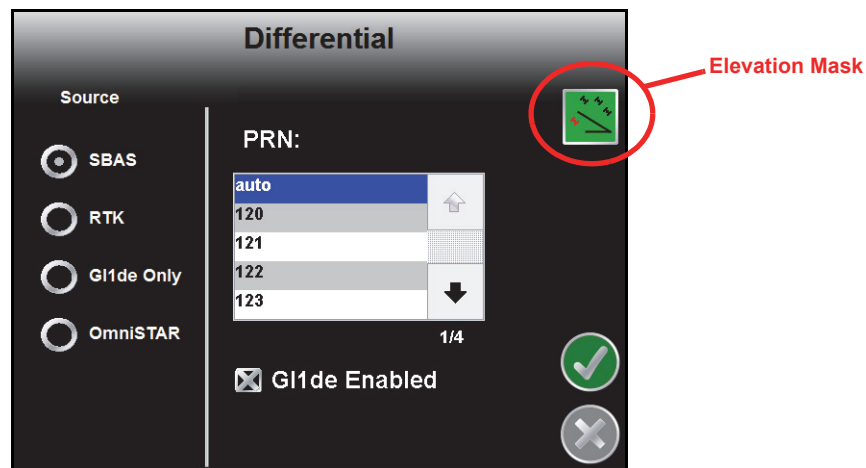

Note: Touch the 'Auto Detect' button on the GPS Health screen if a Raven receiver is connected directly to the 'GPS Receiver/DGPS' port on the chassis interface or main interface cables. If the field computer detects a Raven receiver, the field computer can be used to select the differential source and PRN of the external receiver.

If GPS is routed through an assisted steering system such as the Raven SmarTrax, the receiver cannot be configured with the field computer.

Elevation Mask

The elevation mask sets the minimum elevation of a satellite above the horizon which the field computer may use for differential correction. This value is displayed in degrees above horizontal.

Touch the Elevation Mask icon in the upper, right corner of the Differential screen and use the on-screen keypad to modify the elevation mask setting. The default value for the elevation mask is 4.0.

The current elevation mask value is displayed on the GPS Health screen.

SBAS (Satellite Based Augmentation System)

Note: *Some Envizio Pro field computers may have an internal receiver enabled for e-Dif and L-Dif only. These receivers do not have an SBAS option and will not be able to utilize SBAS correction signals.*

Select the SBAS option to utilize the Wide Area Augmentation System (WAAS) or European Geostationary Navigation Overlay Service (EGNOS) correction signals. For most internal GPS receivers, this is the default option selected.

PRN (Pseudo-Random Number). The PRN scroll list allows the operator to manually set the PRN, or pseudo-random number, for the differential satellite which provides coverage for the operation area if desired. Selecting a PRN from the list locks the correction signal to the selected satellite. If the 'auto' option is selected, the field computer will scan and automatically set the PRN throughout an operation.

GL1DE Smoothing. Toggle the "GL1DE Enabled" option to enable the NovAtel GL1DE[®] algorithm while using SBAS corrections. When enabled, the NovAtel GL1DE feature helps to smooth reported GPS positions and reduce position jumps during operation and provides for a more stable position input for guidance systems.

Note: *The NovAtel GL1DE feature is only available on Envizio Pro II field computers with the dual frequency GPS receiver. Visit the NovAtel web site for a full description and additional information on the NovAtel GL1DE feature.*

www.novatel.com

GLONASS Authorization. An optional Global Navigation Satellite System (GLONASS) authorization key is also available to enhance the standard GPS satellite constellation. This key allows the dual frequency receiver to utilize the GLONASS satellite constellation which can increase the number of satellites visible at any given time and help improve satellite coverage.

Note: *The GLONASS satellites will be utilized when the internal receiver is configured for the following correction sources:*

- *GL1DE Only*
- *RTK using RTCM v 3.0*
- *OmniSTAR G2*
- *Satellite GS or Slingshot GS*

e-Dif (Envizio Pro Only)

If an optional e-Dif key has been authorized, an option to enable e-Dif will be displayed on this screen. Select the e-Dif option to display the timer for the last time the e-Dif was reset. Touch the Reset button to reset the timer.

Note: *The Envizio Pro internal DGPS receiver is e-Dif capable. If connecting an external receiver to the Envizio Pro console, make sure that it is capable of using e-Dif prior to purchasing or authorizing an e-Dif code.*

Contact a local Raven dealer for more information about the optional e-Dif correction source and upgrades.

RTK (Envizio Pro II Only)

With an optional RTK authorization key, the Envizio Pro II dual frequency receiver may be used with a Slingshot[®] Field Hub to receive RTK corrections via a wireless or cellular service provider or via a Continuously Operating Reference Station (CORS) network.

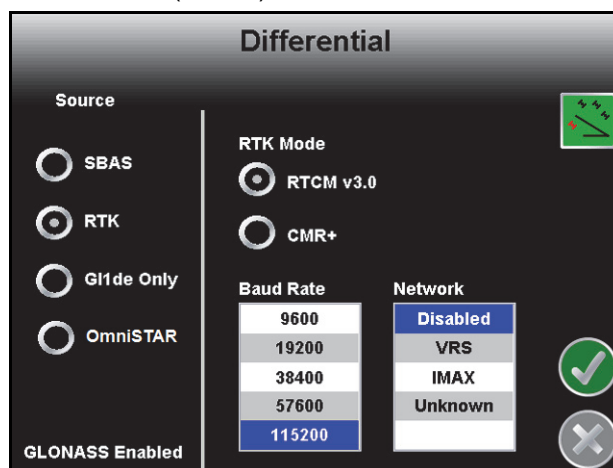

Note: The RTK option is only displayed after an RTK authorization key is entered using the procedure in the Special Features Registration section on page 138. Contact a local Raven dealer to obtain the authorization code or for more information on the Slingshot RTK services.

Check that the following settings are configured correctly to ensure that RTK corrections are used by the on-board receiver:

RTK Mode. Select the format of the correction messages sent from the RTK correction source. The default setting is RTCM v3.0.

Baud Rate. Select the baud rate at which the correction messages are transmitted from the RTK correction source. The default baud rate setting is 115200.

Network. Select the network from which the RTK corrections will be delivered. The default setting is 'Disabled' and is recommended when connected with a Slingshot Field Hub.

GL1DE[®] Only

For areas with limited SBAS coverage, the Envizio Pro II dual frequency receiver features the NovAtel GL1DE as a GPS correction source option. In GL1DE only mode, the Envizio Pro II will use existing GPS or EGNOS satellites to locate the vehicle position within 20 in [50 cm].

OmniSTAR

Note: Field computers with version 6.400 or newer GPS firmware are not compatible with OmniSTAR correction services. See the GPS Status Display Information section on page 122 section for assistance with verifying the firmware version installed on the receiver. Contact a local Raven dealer for information on correction services available for field computers with newer firmware versions or for additional assistance.

If the OmniSTAR correction service is selected for differential corrections, the Differential screen will display subscription status information and region of operation.

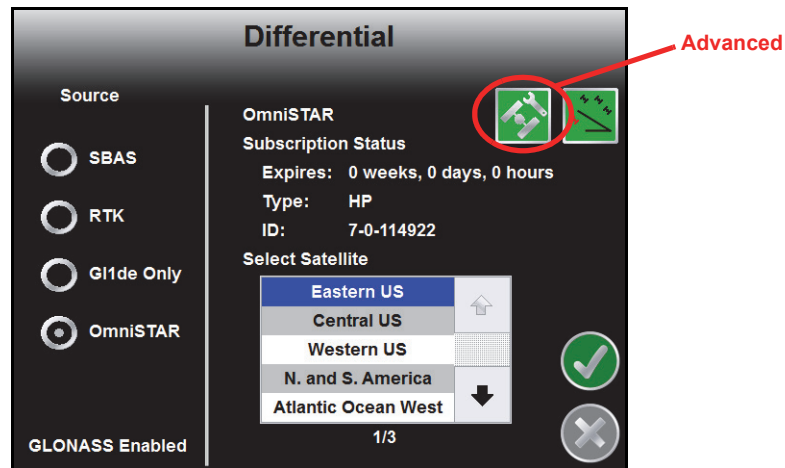

Advanced Menu

Touch the Advanced Menu icon in the upper, right corner of the screen access additional OmniSTAR correction settings. The following options and information will be displayed on the OmniSTAR Advanced Menu screen:

Enable Custom Satellite. Enable custom satellite frequency and rate settings only when instructed by an OmniSTAR technician.

Custom Frequency. The Custom Frequency button displays the current satellite frequency used with OmniSTAR corrections.

Custom Rate. The Custom Rate button displays the current message rate for OmniSTAR corrections.

Signal Strength. Displays the signal strength of the selected satellite.

Subscription Status

The subscription status area displays the following subscription information when available:

Note: If SmarTrax is connected to the Envizio Pro field computer, the operator must set the correction source to "Internal" before the following information will be available. Be sure to move the vehicle to a location with a clear view of the sky before contacting OmniSTAR for subscription information.

Expiration. The time until the current subscription will expire is displayed in weeks, days, and hours. Contact OmniSTAR for subscription information.

Type. The type of subscription will be displayed in this area. OmniSTAR corrections are available in HP, XP, and G2 modes.

ID. The OmniSTAR ID is required for registration with the OmniSTAR correction service.

Select Satellite

Use the scroll list to select the region in which the field computer will be operating. This is necessary to ensure that the receiver utilizes corrections appropriate for the area in which the receiver is operating. A satellite selection guide is available on the OmniSTAR web site:

www.omnistar.com

Satellite GS

If the Satellite GS correction service is selected for differential corrections, the Differential screen will display subscription status information and the regional satellite currently selected for corrections.

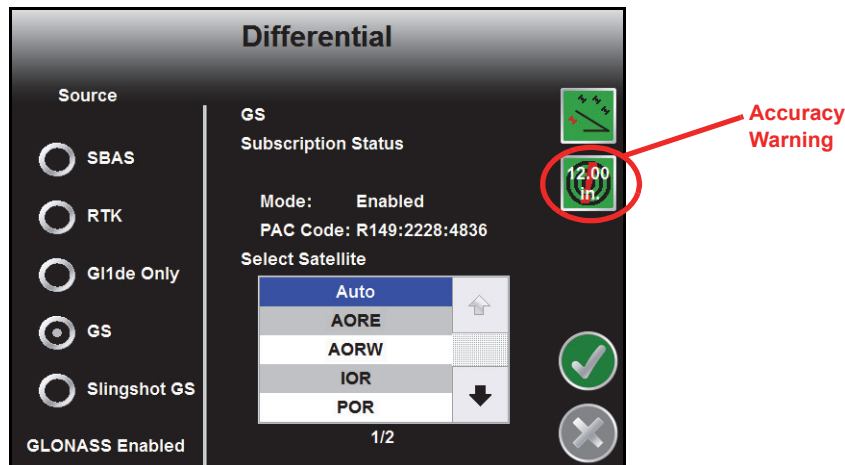

Subscription Status

The subscription status area displays the following subscription information when available:

Note: *If SmarTrax is connected to the Envivio Pro field computer, the operator must set the correction source to "Internal" before the following information will be available. Be sure to move the vehicle to a location with a clear view of the sky before contacting a local Raven dealer for subscription assistance.*

Expiration. The time until the current subscription will expire is displayed in days and hours. Contact a local Raven dealer for subscription information.

Mode. This field will display whether the GS subscription is enabled or disabled. The mode must display Enabled to allow Satellite GS corrections during field operations.

PAC Code. The PAC Code is required for registration with the Satellite GS correction service.

Select Satellite

Use the scroll list to select the region in which the field computer will be operating. This is necessary to ensure that the receiver utilizes corrections appropriate for the area in which the receiver is operating. A satellite selection guide is available at the Raven web site:

www.ravenhelp.com

Accuracy Warning

Touch the Accuracy Warning button along the right side of the screen and use the on-screen keypad to set the allowable horizontal accuracy, in inches [centimeters], which will be allowed before the field computer will provide a GPS accuracy warning or the GPS status shield will turn yellow during operations.

Note: *Higher values will allow the receiver to converge faster, but will allow more horizontal position error. Smaller values will provide more accurate position, but will take longer to converge and are more likely to lose a converged status during field operations.*

Slingshot® GS

If the Slingshot GS correction service is selected for differential corrections through the Slingshot wireless network, the Differential screen will display the following options.

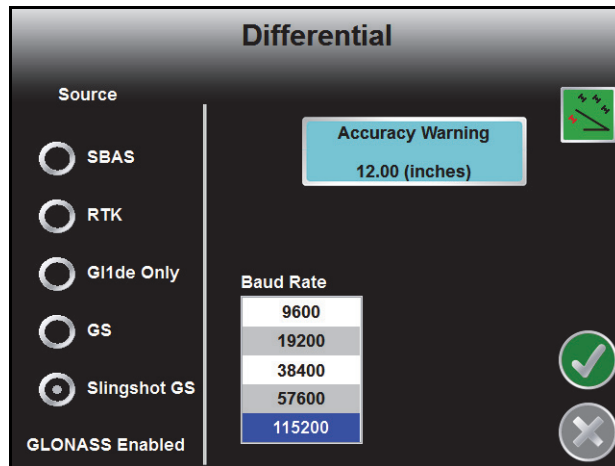

Accuracy Warning. The accuracy warning value sets the allowable horizontal accuracy for field operation. When the field computer determines the position solution meets the set value, the solution will be considered converged and the appropriate status will be displayed.

Note: *Higher values will allow the receiver to converge faster, but will allow more horizontal position error. Smaller values will provide more accurate position, but will take longer to converge and are more likely to lose a converged status during field operations.*

Baud Rate. Select the baud rate at which the correction messages are transmitted from the correction source. The default baud rate setting is 115200.

Default Differential

The Default Differential screen replaces the Differential screen if:

- any non-Raven external GPS receiver connected to the field computer for position corrections.
- the field computer is not able to determine the type of differential corrections provided for position corrections.
- GPS messages are passed through a Raven TM-1 Tilt Module or SmarTrax steering system.

In any of the conditions outlined above, the Default Differential screen allows the operator to manually set the type of corrections being used for position information and corrections.

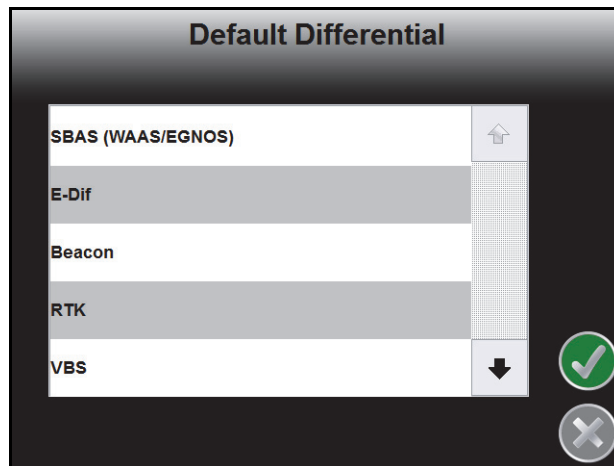

Selecting the appropriate source of differential corrections allows the Envizio Pro to display the GPS Status Icon as outlined in the *GPS Status* section on page 52. The Default Differential selection also allows the field computer to identify and display potential GPS error conditions during field operations.

Important: Potential error conditions must be verified and addressed on the external receiver or the source setting must be set to Internal to access the internal GPS receiver settings.

Output

Important: If a SmarTrax assisted steering system is connected to the Envizio Pro field computer, set the correction source to internal before making changes to the Envizio Pro internal receiver.

To setup the type, frequency, and baud rate of message outputs from the built-in receiver, touch the Output icon.

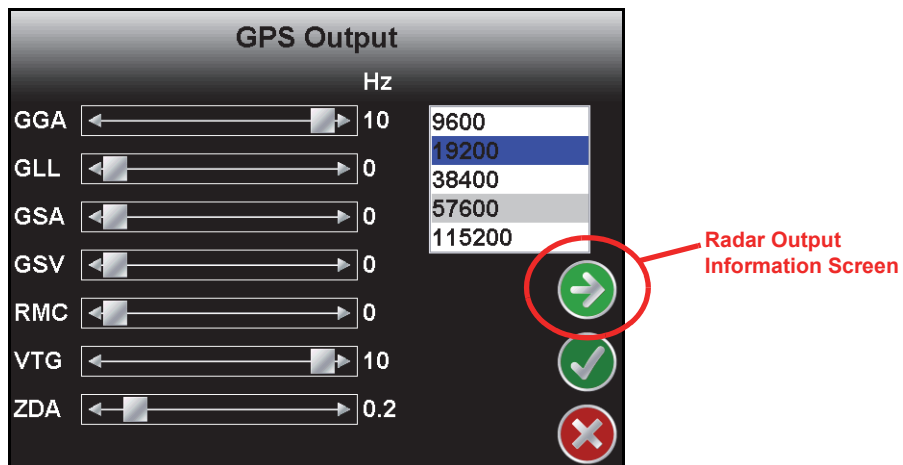

Note: The GPS Output screen is only available when using the internal GPS receiver. Message outputs from an external GPS receiver must be setup through the external hardware.

Message Types and Frequency

Use the sliding bar next to the desired message type to set the frequency of the output message. Messages may be sent out at 0.2, 1, 5 or 10 Hz, depending upon the message. Set the slider to 0 Hz to turn the message off.

Messages sent out of the built-in receiver are sent out of the connector labeled 'GPS Out' on the auxiliary interface cable or chassis interface cable. Contact a local Raven dealer for more information.

Baud

Select the Baud Rate of the message strings sent from the built-in receiver.

Note: *Some GPS or Assisted Steering components may require specific Baud Rate settings.*

Simulated Radar Output

Touch the 'Next' icon displayed on the GPS Output screen to view the simulated radar output from the field computer. These settings may be used to help set up an external device to receive GPS speed signal output from the internal GPS receiver.

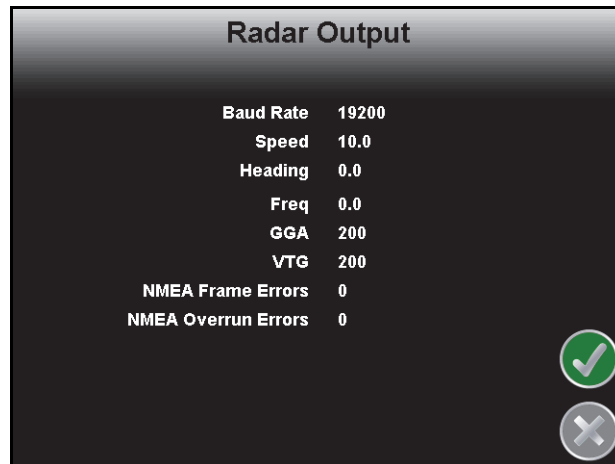

External Light Bar, TM-1 Tilt Module and SmarTrax™

If an optional SmarTrax system, external light bar or TM-1 Tilt Module is connected to the field computer, the GPS Output Baud setting must be set to 19,200 before changing the Source selection. For more information on the GPS Source settings, see the *Source* section on page 133.

Source

Important: If a SmarTrax assisted steering system is connected to the Envizio Pro field computer, set the correction source to internal before making changes to the Envizio Pro internal receiver.

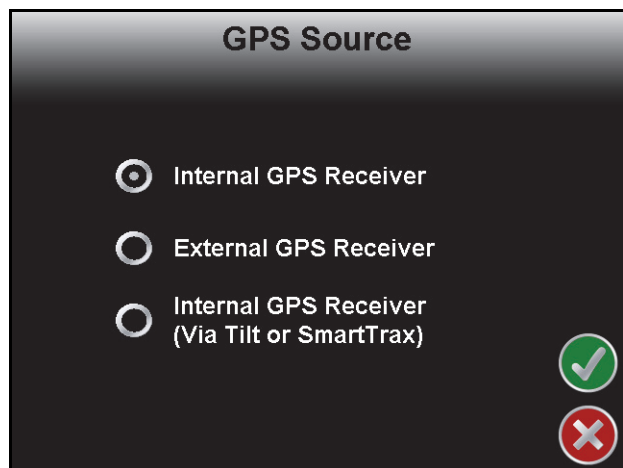

The GPS Source screen allows the operator to select between the internal GPS receiver or an optional external receiver such as a Raven Phoenix 200/300.

Note: The GPS Source screen is only available on field computers with the internal DGPS receiver.

The GPS Source screen also displays an option to automatically setup the output messages from the built-in receiver to route through an optional TM-1 Tilt Module or SmarTrax system.

Internal GPS Receiver

To use the internal receiver, select the 'Internal GPS Receiver' option. Verify settings on the GPS Output

screen to ensure that any required messages are properly configured.

Via TM-1 or SmarTrax™

Important: If a SmarTrax assisted steering system is connected to the Envizio Pro field computer, set the correction source to internal before making changes to the Envizio Pro internal receiver.

To output DGPS signal from the built-in receiver to an optional TM-1 Tilt Sensor or SmarTrax controller, select the Internal GPS Receiver (Via Tilt or SmarTrax) option.

Note: The GPS Output Baud must be set to 19,200 before selecting the Via TM-1 or SmarTrax option (see the External Light Bar, TM-1 Tilt Module and SmarTrax™ section on page 132). Do not select this option if the optional hardware components are not connected. The field computer may take several minutes to properly setup these components or may lock up if the TM-1 or SmarTrax controller are not connected.

This option requires additional cables to route DGPS signal from the internal receiver out to the TM-1 or SmarTrax controller and then back into the field computer. Review the installation sections for these optional system components or contact a local Raven dealer for more information.

External GPS Receiver

If an optional external GPS receiver is connected to the field computer via the connector labeled 'DGPS' on the main interface cable (P/N 115-0171-746) or chassis interface cable (P/N 115-0172-001) select the External Receiver option. Selecting this option overrides the internal DGPS receiver.

Tilt Sensor

If the TM-1 Tilt Sensor is connected directly to the DGPS connector on the main interface cable (P/N 115-0171-746) or chassis interface cable (P/N 115-0172-001), the Envizio Pro may be used to configure the TM-1. Touch the Tilt icon to access the Tilt Configuration screen.

Note: *When routing tilt corrected signal through a SmarTrax controller and back into the field computer, the TM-1 must be calibrated through the SmarTrax controller rather than the Envizio Pro. See the SmarTrax Quick Start Guide or Operator's Manual for more information.*

Information

Touch the blue Information icon to display a brief explanation of the settings and options available on the Tilt Configuration screen.

Note: *Refer to the TM-1 Tilt Module Installation and Operation Manual for detailed installation and calibration information.*

Drift Shift

The drift shift feature allows the operator to manually adjust, or nudge, the reported GPS position of all features (e.g. boundaries, coverage and zone maps, field markers, and guidance lines, etc.) within the job simultaneously. This feature allows the operator to manually correct for GPS drift over the course of a field operation or to “recalibrate” the position of field features if the job is resumed at a later date or time.

Note: *It is necessary to stop the vehicle while nudging job features. When enabled, the drift shift feature will automatically pan and zoom onto the current vehicle location to allow the operator to adjust the position of job features based upon the current vehicle location.*

Drift Shift Enable. Touch this option to toggle the drift shift feature on or off. Ensure this option is selected to allow the drift shift features to be used during field operations.

Set Drift Correction Now. With the vehicle positioned at the actual reference point, touch the “Set Now” button to shift the displayed reference point and all field features according to the current vehicle position.

Set Reference Point Here. Touch the “Set Here” button to reset the reference point to the current vehicle location. The previous reference position will be lost.

Shift Increment 1 and 2. Enter increments for manually adjusting field features with drift shift. These values allow a coarse and fine adjustment to allow the operator to shift the coverage map as necessary during the field operation.

Reset Shift Increments. Reset the default 6 in [15 cm] and 36 in [91 cm] drift shift values for increments 1 and 2.

Computer Menu

The Computer menu contains settings and preferences for the Envizio Pro field computer and display. Settings such as the display mode, brightness, language, light bar and display units are modified through the Computer menu. Features available with a USB flash drive, such as software updates and file maintenance are also accessed via the Computer menu.

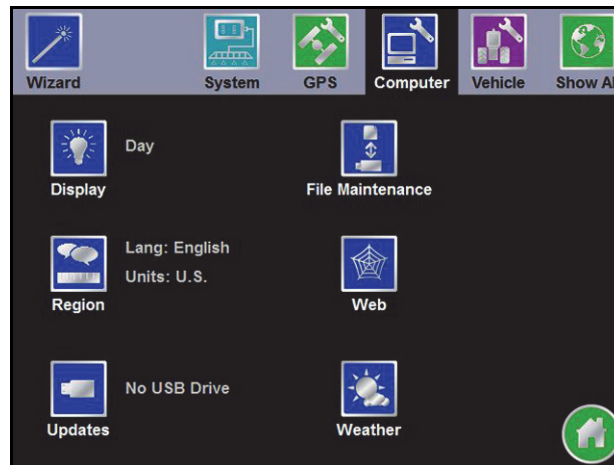

Display

The Display settings screen allows the user to change settings for the field computer screen display and the on-screen light bar.

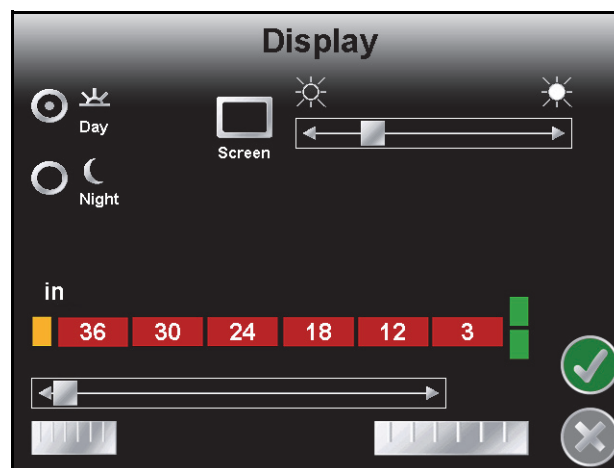

Display Mode

Select Day or Night to adjust the guidance screen for day or night operations.

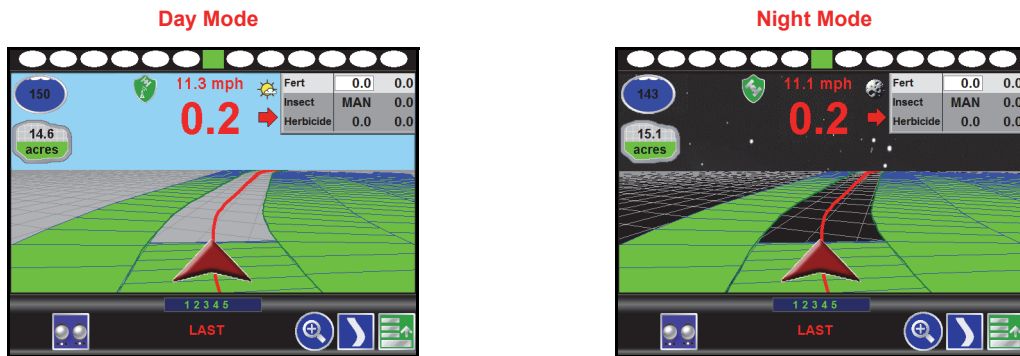

Screen Brightness

The Screen slider adjusts the brightness of the field computer display.

On-Screen Light Bar

Offset Scale Sensitivity. The light bar sensitivity can be adjusted to match the type of application with which the field computer will provide guidance. Select between the coarse, normal, and fine adjustments. The example light bar displays the units and measurements used for each setting.

External Light Bar

The brightness of an external light bar, controlled by the field computer, may be adjusted using the External Light Bar slider on the Display screen.

Note: *The External Light Bar adjustment will only display if the field computer is configured to control an external light bar. See the Serial Port Configuration section on page 98 to setup the external light bar interface.*

Region

Select the Region icon to modify display settings for the region in which the field computer will be used. The Region screen displays settings for the following:

- Language
- Display Units
- Pressure Units

Language

The available languages are displayed in the scroll list. Select the desired language displayed on the field computer from the list.

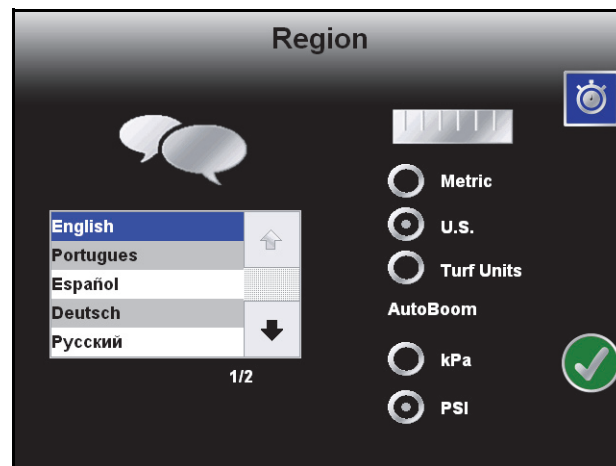

Unit System

Select the desired system (English or Metric) used with the control system.

| Unit System | Units |
|-------------|---|
| Metric | centimeters (cm), liters (L), hectares (ha), kilometers per hour (km/h) |
| English | inches (in), gallons (gal), acres (ac), miles per hour (mph) |
| Turf Units | inches (in), gallons per 1000 square feet (gal/1000 ft ²), miles per hour (mph) |

All measurements will be displayed by the field computer in the selected system. All user inputs must be entered using the selected system.

AutoBoom[®] Pressure

The units used to display pressure of an optional AutoBoom system are also selected on this screen. Select between pounds per square inch (PSI) or kilo pascals (kPa).

Time Zone Settings



Touch the Time Zone icon in the upper right corner to view and modify time zone settings. The default selections will allow the field computer to automatically configure the time zone and daylight savings for the region. To manually change the time zone, select the 'Manual Time Zone' option and enter the UTC (Coordinated Universal Time) offset hours for the local time zone.

Updates

Access the Updates screen to update the field computer software or to register a special feature, such as VRA or planter population control. The Updates screen also provides access to the demonstration, or demo, mode.

Software Updates

Software updates for the field computer will be available periodically from the Raven web site:

www.ravenhelp.com

Refer to the *Updates* section on page 160 for detailed instructions on downloading and applying software updates to the Raven Envizio Pro field computer.

Special Features Registration

The Updates screen also offers the ability to activate special features using activation keys for the field computer as well as some Raven control nodes. While on the Updates screen, touch the 'Special Features Registration' button to begin activation of available features.

Note: Contact a local Raven dealer for a complete list of features or activation codes. Consoles with software version 3.0 or higher will require an activation key to allow operation. If 'CE 6.0' is not listed in the enabled features list, contact a local Raven dealer or the Raven Technical Support Center for assistance.

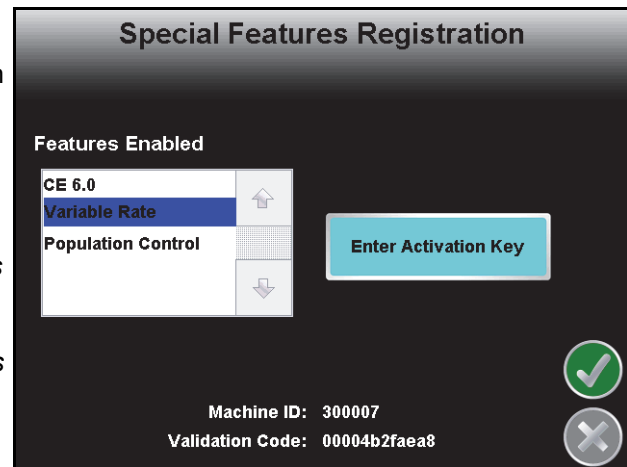

The Raven dealer will require the Machine ID and Validation Code information displayed at the bottom of the Special Features Registration screen to generate the authorization code.

To Activate a Special Feature.

1. Obtain a registration code from a local Raven dealer.
2. Visit the Raven web site below and fill out the Activation Key Request form with the registration code received from the Raven dealer.

www.ravenhelp.com

3. Submit the request form to receive the activation key used to unlock the special feature on the Envizio Pro field computer.

Note: Refer to the *To Authorize Raven Control Node Features* section on page 139 or the *To Authorize Internal DGPS Receiver Features* section on page 139 for special instructions on entering activation codes for these components.

4. On the Envizio Pro, touch the Tools Menu icon on the Home screen.
5. Select the Updates icon from the Computer menu.
6. Touch the Special Features Registration button to access the Special Registration Features screen.
7. Touch the Enter Activation Key button and use the on-screen keyboard to enter the activation key received from the Raven web site.

8. Touch the Accept icon in the lower, right corner of the on-screen keyboard to confirm the activation key.
9. Touch the 'Next' icon on the right side of the screen to activate the special feature.
If the key has been entered correctly, the activated feature will be displayed on-screen.
If the activation key does not activate the feature, verify that the key has been entered correctly.

To Authorize Raven Control Node Features.

Note: *A Raven node with optional features must be connected to the field computer to enable additional features.*

1. Obtain an registration code from a local Raven dealer.
2. Visit the Raven web site below and fill out the Activation Key Request form with the registration code received from the Raven dealer.

www.ravenhelp.com
3. Submit the request form to receive the activation key used to unlock the special feature on the Envizio Pro field computer.
4. On the Envizio Pro, touch the Tools Menu icon on the Home screen.
5. Select the Updates icon from the Computer menu.
6. Touch the Special Features Registration button to access the Special Registration Features screen.
7. Touch the Enter Activation Key button and use the on-screen keyboard to enter the activation key from the Raven web site.
8. Touch the Accept icon in the lower, right corner of the on-screen keyboard to confirm the authorization code. If the key has been entered correctly, the field computer will display a prompt confirming the code has been accepted. The node activation key will not be displayed on the Special Features Registration screen. Check the CAN Diagnostics screen or test the control system to verify that the special feature(s) purchased are accessible.

To Authorize Internal DGPS Receiver Features.

1. From the Envizio Pro II home screen, touch the Tools Menu (blue) button and select the Source icon from the GPS menu.
2. On the GPS Source screen, write down the current source setting before selecting the Internal GPS Receiver option.
3. Touch the Accept icon to return to the main Tools Menu display.
4. Select the Output icon from the GPS menu.
5. On the GPS Output screen, write down the current NMEA message rates before setting all NMEA messages to zero.
6. Touch the Accept icon to return to the main Tools Menu display.
7. Select the Updates icon from the Computer menu.
8. Touch the Special Features Registration button to access the Special Registration Features screen.
9. Touch the Enter Activation Key button and use the on-screen keyboard to enter the activation key from the Raven web site.
10. Touch the Accept icon in the lower, right corner of the on-screen keyboard to confirm the authorization code.
11. Touch the Next icon. If the key has been entered correctly, the field computer will display a prompt confirming the code has been accepted. Verify that the feature is available in the differential screens. New GPS correction features may take a couple minutes to display properly. If the feature is still not available after 5 minutes, restart the field computer and reattempt to access the new feature. Contact a local Raven dealer if additional assistance is still required.

Demo Mode

Touch the Demo icon in the upper-right corner of the Updates screen to toggle the demonstration mode. This mode enables a GPS simulation. The field computer will create a coverage map based on the simulated GPS position.

To start the demonstration mode:



Touch the Start Demo icon to toggle the demo mode on. The field computer must be restarted before the demonstration mode will be activated. Shutdown and power off the console. Wait a few seconds and turn the console power back on.



To end demo mode, return to the Updates screen and select the Stop Demo icon to toggle demo mode off. Be sure to restart the field computer to restore the Envizio Pro to normal operation.

File Maintenance

To transfer files to or from the field computer, select the File Maintenance icon in the Computer menu. The following File Maintenance may be conducted directly from the field computer:

- Setup required file structure for use with the field computer on the USB drive
- Copy files to USB drive
- Copy files from USB drive
- Delete files from internal memory

Raven recommends performing File Maintenance at least once a week and storing or backing up these files on a home or office PC. See Chapter 8, *Software Updates and File Maintenance* for details on using the File Maintenance feature.

Note: *Depending upon the size of the completed job(s), file maintenance may take several minutes to complete.*

*When interfacing with a planter control or yield monitor system, a typical job of 200 acres should take less than 5 minutes. Larger fields and coverage maps with several sections (e.g. MultiRow or Individual Row Control) could take significantly longer. Check the File Maintenance screen available memory display periodically and perform file maintenance as necessary. Refer to Chapter 8, *Software Updates and File Maintenance*, for more information.*

Wireless File Transfer

If a Slingshot[®] Field Hub is connected to the field computer, job files may be transferred to a home or office computer automatically at the end of each job. Refer to Appendix C, *Wireless Communications & Remote Service*, for more information on setting up and using Slingshot and the wireless file manager to manage job file transfers.

Web

If the required components are connected to the ethernet port on the back of the field computer, pressing the Web button will allow the operator to access the world wide web via the field computer touch screen. Refer to the Field Hub Quick Start Guide for set up and wireless navigation instructions.

Vehicle Menu

Use the Vehicle menu to configure the field computer for the machine or implement configuration. The field computer requires calibration for the GPS antenna location on each vehicle as well as the swath width (guidance width) and the section configuration for the machine or implement. Once configured, vehicle profiles can be saved for later use, transferred to a USB drive, or loaded onto another Envizio Pro field computer.

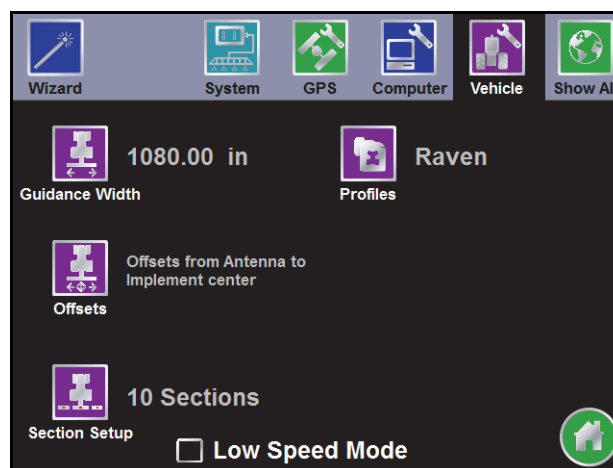

Low Speed Mode

A filter is normally applied to the course over ground or heading information displayed by the Envizio Pro at speeds under 1.5 mph [2.4 km/h]. The low speed mode reduces the minimum speed to 0.7 mph [1.1 km/h] for operations and equipment that require normal operation speeds near this range. It is recommended to disable the low speed mode if the normal operation speeds for field operations will be above 1.5 mph [2.4 km/h] consistently.

Guidance Width

Use the on-screen keypad to enter the guidance width in inches [centimeters] for the boom, implement, or header.

The guidance width should be entered as the width of the boom, implement or header which actually completes an operation while the vehicle drives a swath. A few examples of the guidance widths for various implements would include the following:

- Enter the guidance width for a sprayer boom as the number of spray tips multiplied by the tip spacing. The entered guidance width should not include fence row nozzles or foam markers.
- The guidance width of a combine header should be the cutting surface, not the overall header width.
- The guidance width for row crop planters is equal to the row spacing multiplied by the number of row units.

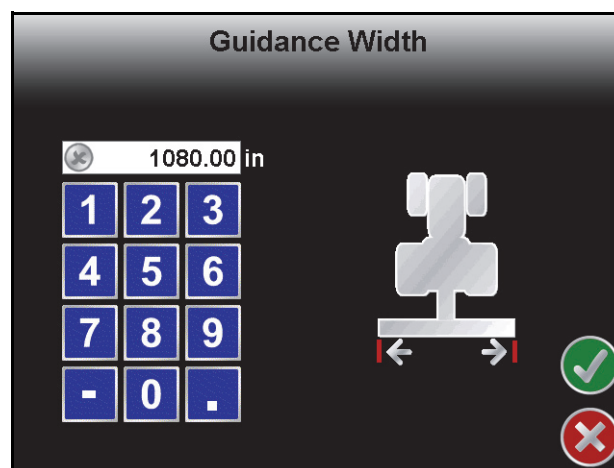

Offsets and Implement Type Selection

To properly display the vehicle location within a field and create accurate coverage information, the field computer must be calibrated for the location of the center of the boom or implement and the relative location of the GPS antenna. This information is used by the field computer to provide accurate swath guidance and to create coverage maps based on the location of the implement.

Select one of the following implement types with which the field computer will interface during field operations:

Important: *It is highly recommended to create and save profiles for each specific vehicle, tractor and implement configuration on which the field computer will be used for field operations.*

Important: *Anytime the implement configuration or the antenna location is changed, be sure to verify that the section and implement offsets are set up correctly.*

Self Propelled or Mounted Implement. This option is best suited for fixed implements such as self-propelled sprayer, a harvester or combine, or an implement mounted to a tractor 3-point hitch. See the *Self Propelled or Mounted Implement* section on page 142 for details on configuring implements using this implement type.

Trailed Implement. Select this option to configure implements such as anhydrous tool bars, pull-type sprayers, planters, or air seeders with the air cart towed behind the seed drill. Refer to the *Trailed Implement Tractor Setup* section on page 144 to begin configuring the trailed implement.

Trailed Implement with Tow Between. This option has been designed for seeder implement configurations with the air cart towed between the tractor and seed drill. Refer to the *Trailed Implement Tractor Setup* section on page 144 to begin configuring the trailed implement.

Self Propelled or Mounted Implement

If the Self Propelled or Mounted Implement option is selected on the Implement Type selection screen, touch

the Next  icon to display the Raven Offsets Setup screen. The antenna position settings shown on this screen are used to calibrate the field computer for the relative location of the center of the boom or implement with respect to the DGPS antenna.

Note: *Be sure to enter positive values for each offset setting. All negative values entered will be reset to zero.*

Raven Offsets Setup

Antenna Position



Units: in.

| | |
|----------------|--------|
| Fore / Aft | 60.00 |
| Left / Right | 0.00 |
| Antenna Height | 144.00 |

Implement in Front
 Left of Center



The Raven Offsets Setup screen displays the currently calibrated values for the following antenna offsets:

Fore or Aft Offset. The fore/aft offset is the distance of the boom or implement in front or behind the GPS antenna. The fore/aft offset must be measured perpendicular to the boom or implement width. See Figure 1 below.

FIGURE 1. Example of the Fore/Aft Measurement

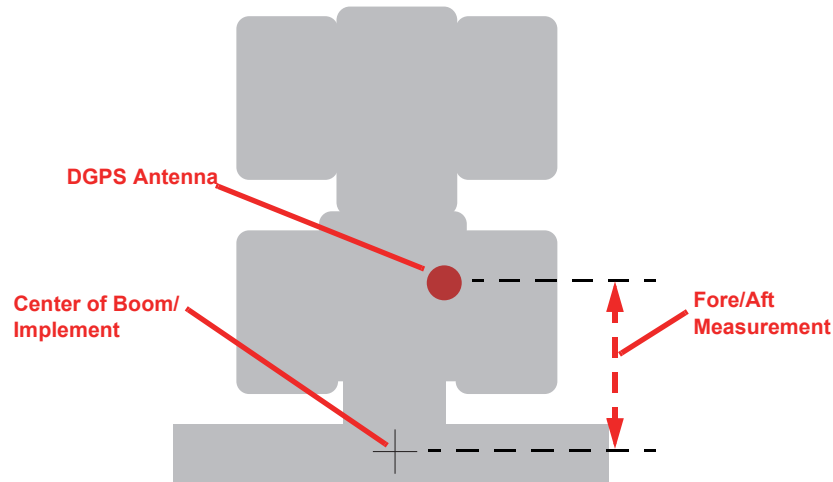

To set the fore/aft value:

1. Touch the current fore/aft value displayed on the Raven Offsets Setup screen.
2. Use the keypad to enter the measured fore/aft value in inches [centimeters]. If the boom or implement is in front of the GPS antenna, select the 'Implement in Front' option.

Left or Right Offset. The left/right offset is the distance from the GPS antenna to the center line of the boom or implement.

Note: *The left/right offset must be measured parallel to the boom or implement width. See Figure 2 below.*

FIGURE 2. Example of Left/Right Measurement

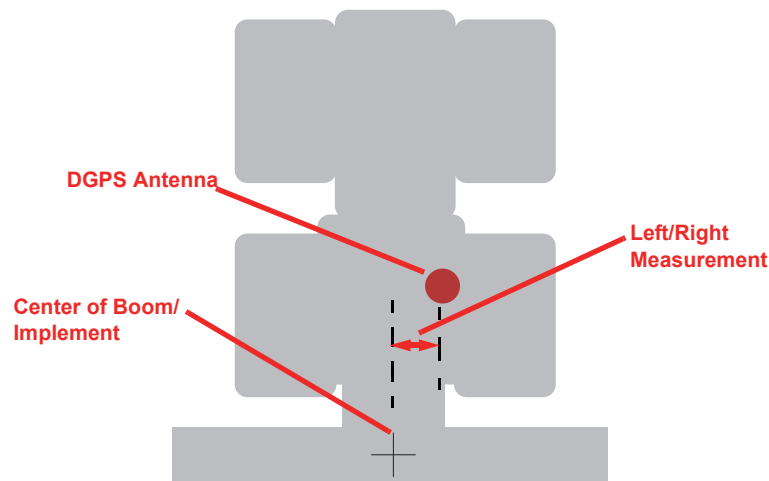

To set the left/right value:

1. Touch the current left/right value displayed on the Raven Offsets Setup screen. Use the keypad to enter the measured left/right value in inches [centimeters]. If the center line of the boom or implement is to the left of the GPS antenna, select the 'Left of Center' option.

Antenna Height. The height value is the measurement from the ground to the bottom of the GPS antenna.

Note: *This value is only required if a tilt corrected DGPS signal is sent to the field computer.*

To set the Height value:

1. Touch the current height value displayed on the Raven Offsets Setup screen.
2. Use the keypad to enter the measured height of the antenna in inches [centimeters].

Trailed Implement Tractor Setup

If either of the trailed implement options are selected on the Implement Type screen, touch the Next  icon to display the Tractor Offset Setup screen. The antenna position settings are used to calibrate the field computer for the relative location of the tractor pivot point with respect to the GPS antenna position.

Important: *The pivot point for a conventional tractor is the center of the rear axle. The pivot point for a tracked tractor is the center of the track length between the tracks. The pivot point for an articulated tractor is the point of articulation.*

1. Touch the drop down selection in the upper, left corner of the screen and select the tractor type which will be used with the control system.
2. Review the following definitions of the offsets necessary to complete the tractor setup process. These values are critical for performance of the field computer and product or implement control system. Measure carefully and enter the offset values as accurately as possible to help ensure the best results.

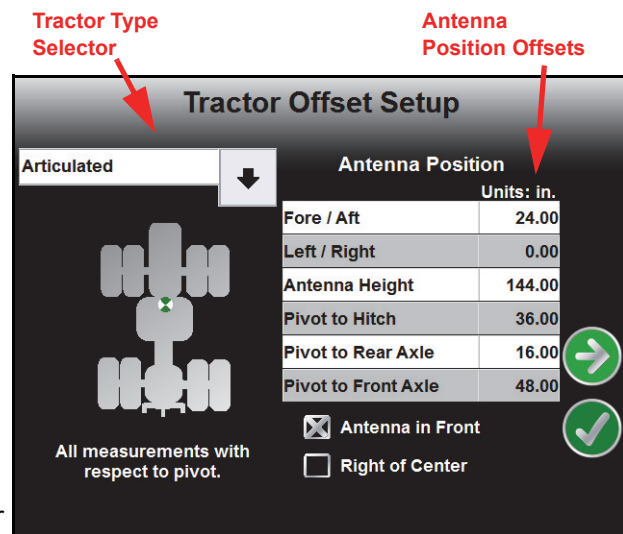

Fore/Aft Offset. The fore/aft offset is the distance of the GPS antenna in front or behind the pivot point. The fore/aft offset must be measured parallel to the direction of travel.

Note: *If the GPS antenna is in front of the pivot point, select the 'Antenna in Front' option at the bottom of the screen. See Figure 1 on page 143.*

Left/Right Offset. The left/right offset is the distance of the GPS antenna to the left or right of the pivot point. The left/right offset must be measured perpendicular to the direction of travel.

Note: *If the GPS antenna is to the right of the pivot point, select the 'Right of Center' option at the bottom of the screen. See Figure 2 on page 143.*

Antenna Height. The antenna height value is the measurement from the ground to the bottom of the GPS antenna.

Pivot to Hitch. The pivot to hitch value is the distance from the pivot point to the vehicle hitch. This value must be measured parallel to the direction of travel.

Important: *The field computer assumes that the vehicle hitch is located directly behind the vehicle pivot point.*

Pivot to Rear Axle. (Articulated Vehicles Only) The pivot to rear axle value is the distance from the pivot point to the center of the rear axle. This value must be measured parallel to the direction of travel.

Pivot to Front Axle. (Articulated Vehicles Only) The pivot to front axle value is the distance from the pivot point to the front axle. This value must be measured parallel to the direction of travel.

3. To enter or edit the antenna offset values on the Tractor Offset Setup screen:
 - a. Touch the desired offset or value to edit.
 - b. Use the on-screen keypad to enter the measured offset value in inches [centimeters].

Note: *The field computer will not recognize a negative value for any of the offset values. Be sure to enter sure to enter positive values for each offset. All negative values entered will be reset to '0.'*

4. Touch the Next  icon to proceed with the trailed implement configuration.

To configure standard pull-type implements (e.g. towed sprayers, anhydrous tool bars, planters, etc.), refer to the *Trailed Implement Setup* section on page 145. Refer to the *Trailed Implement with Tow Between Setup* section on page 146 to set up an implement like an air seeder where the air cart is towed between the tractor and seed drill.

Note: *Use the standard trailed implement type to configure an air seeder system where the air cart is towed behind the seed drill. Use the Previous  icon to return to the Implement Type screen if necessary.*

Trailed Implement Setup

Note: *The following instructions apply to a implement pulled directly behind a tractor such as a pull-type sprayer, anhydrous tool bar or planter. Refer to the Trailed Implement with Tow Between Setup section on page 146 to configure an implement such as an air seeder with the air cart towed between the seed drill and the tractor.*

1. If the standard Trailed Implement option is selected as the implement type, the Offsets will display after the Tractor Offsets Setup screen.
2. Review the following definitions of the offsets for the trailed implement setup. These values are critical for performance of the field computer and product or implement control system. Measure carefully and enter the offset values as accurately as possible to help ensure the best results.

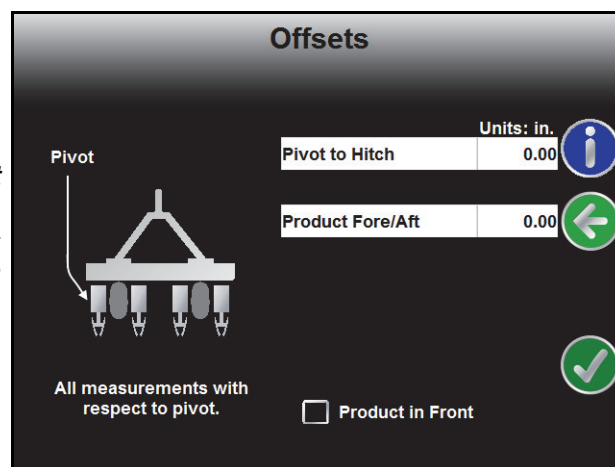

Pivot to Hitch. The pivot to hitch value is the distance from the hitch point to the implement pivot point. The pivot point on an implement is usually either the center of the wheel base which the implement turns around or the point where the implement makes contact with the ground during field operations. This value must be measured parallel to the direction of travel.

Product Fore/Aft. Enter the distance between the implement pivot point and the product sections on the implement. The product sections are the point which completes the desired task during field operations such as the center of the boom on a pull-type sprayer, seed tubes on a planter, knives on an anhydrous tool bar, or the center of the working width of a disc. This value must be measured parallel to the direction of travel.

Important: *If an implement configuration or modification changes the product fore/aft setting, verify that the section configuration will need to be reconfigured. Refer to the Sections section on page 147 for information on setting up the sections and section offsets.*

Product in Front Option. Select the option at the bottom of the screen if the product sections are in front of the implement pivot point.

3. To enter or edit the implement offset values on the Offset screen:
 - a. Touch the desired offset or value to edit.
 - b. Use the on-screen keypad to enter the measured offset value in inches [centimeters].

Note: *The field computer will not recognize a negative value for any of the offset values. Be sure to enter sure to enter positive values for each offset. All negative values entered will be reset to '0.'*

4. Touch the Next  icon to complete the trailed implement configuration.

Trailed Implement with Tow Between Setup

Note: *The following instructions apply to implement configurations such as air seeders with the air cart towed in between the seed drill and the tractor. Refer to the Trailed Implement Setup section on page 145 to configure an implement pulled directly behind the tractor such as a pull-type sprayer, anhydrous tool bar, or planter.*

1. If the Tow Between option is selected as the implement type, the Cart Dimensions screen will display after the Tractor Offsets Setup screen.
2. Review the following definitions of the offsets for the trailed implement setup. These values are critical for performance of the field computer and product or implement control system. Measure carefully and enter the offset values as accurately as possible to help ensure the best results.

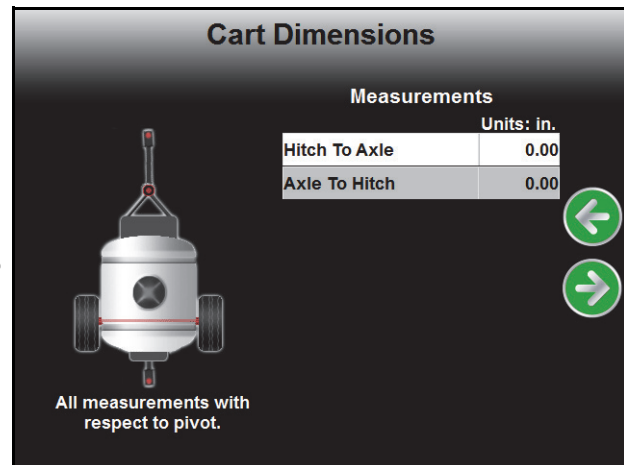

Hitch to Axle. The first value on the Cart Dimensions screen should be measured from the tractor hitch pin to the air cart pivot point, usually the center of the air cart axle.

Note: *If used with a four wheel air cart, the hitch to axle measurement may need to be adjusted to provide accurate trailed implement mapping.*



Measure the value parallel to the direction of travel.

Axle to Hitch. The second value on the Cart Dimensions screen is the measurement from the pivot point to the hitch at the back of the air cart. When the two measurements on the Cart Dimensions screen are added together, the value should equal the overall length of the air cart from the tractor hitch pin to the rear hitch.

Measure the value parallel to the direction of travel.

3. To enter or edit the implement offset values on the Cart Dimensions screen:
 - a. Touch the desired offset or value to edit.
 - b. Use the on-screen keypad to enter the measured offset value in inches [centimeters].

Note: *The field computer will not recognize a negative value for any of the offset values. Be sure to enter sure to enter positive values for each offset. All negative values entered will be reset to '0.'*

4. Touch the Next  icon to proceed to the Drill Setup screen.
5. The final value required for the tow between implement type is the distance between the drill hitch pin to the pivot point of the seed drill. Generally, the pivot point for a seed drill is the center of the rear frame axle.
6. Touch the Next  icon to complete the trailed implement with tow between cart configuration.

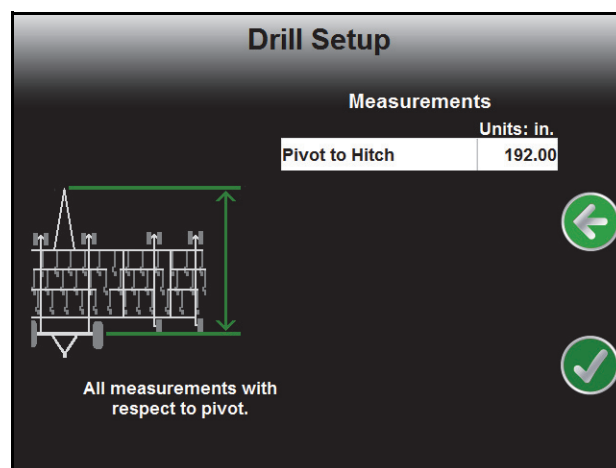

Sections

Touch the Sections icon to display the Section Configuration screen.

| Section | Width | Left / Right | Fore / Aft |
|---------|--------|--------------|------------|
| L | 216.00 | -432.00 | -48.00 |
| 1 | 216.00 | -216.00 | -48.00 |
| 2 | 216.00 | 0.00 | -48.00 |
| 3 | 216.00 | 216.00 | -48.00 |
| R | 216.00 | 432.00 | -48.00 |

The Section Configuration screen shows an overview of the current section configuration including section widths, left or right offsets and fore or aft offsets. This screen is used only to review the current section configuration.

Note: *The reference point for measuring the section left/right and fore/aft offsets depends upon the implement type selected prior to configuring the section configuration.*

- **Self-propelled or mounted Implement** - *The reference point is the antenna position. Offsets must be measured from the antenna to the midpoint of each section.*
- **Trailed Implement** - *The reference point is the implement pivot point, usually the center of the implement wheel base. Offsets must be measured from the implement pivot point to the midpoint of each section.*
- **Trailed Implement with Tow Between** - *The reference point is the rear hitch of the tow between implement. Offsets must be measured from the rear hitch to the midpoint of each section.*

Review the Offsets and Implement Type Selection section on page 142 for details on measuring section offsets.

Section Setup

1. On the Section Configuration screen, touch the Next  icon to begin configuring sections.

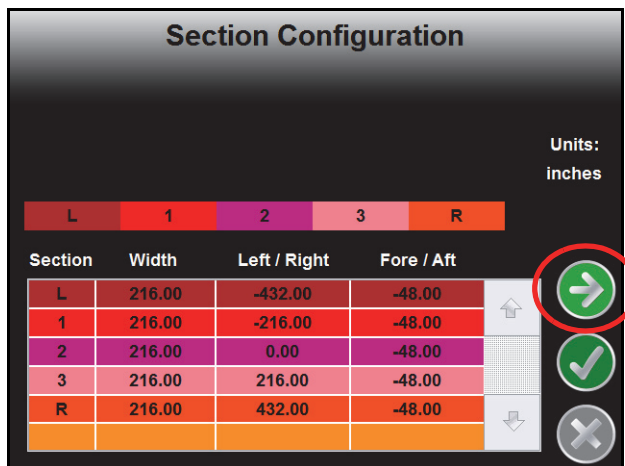

The Number of Sections screen is displayed.

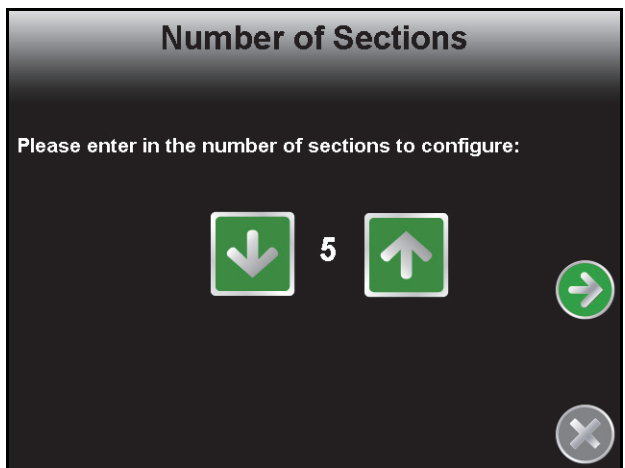



2. Use the Up and Down arrow buttons to setup the number of sections for the vehicle or implement. Touch the Next  icon to proceed to the Section Width screen.

Note: To utilize AccuBoom, automatic boom section control, plumbing on the vehicle or implement must allow for individual section control. If the equipment is not capable of controlling individual sections, set the number of sections to 1 and enter the overall boom or implement width on the Section Width screen.

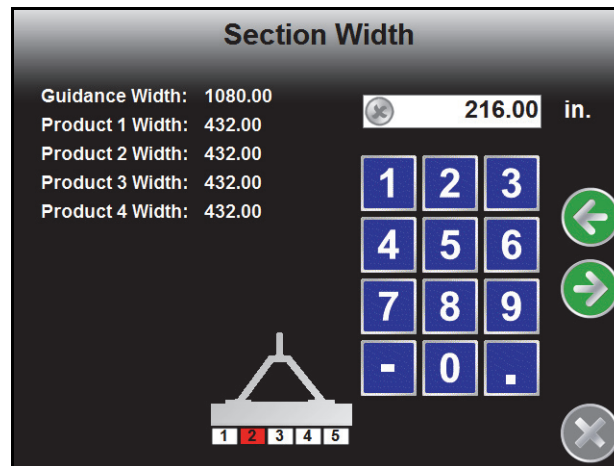
- Configure the width of each section starting with the far left section. Use the on-screen keypad to enter the section width.



Touch the Next  icon to accept the entered value and advance to the next section to the right. To skip a section, enter a value of zero as the section width.

- Repeat step 3 until widths have been entered for all sections. Touch the Next  icon on the last Section Width screen to advance to the Configure Sections screen.

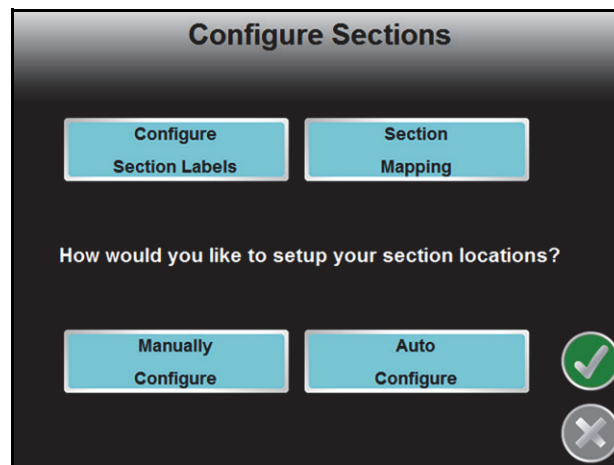

This screen allows the operator to configure the section labels, set the switch assignments for each section, and to configure the location for each section on the machine or implement.

- Touch the Configure Section Labels button to edit the section labels displayed on the field computer if desired.
- Select the Section Mapping button to reconfigure sections to section switches for customized switch box functionality during field operations.
- The Manual and Auto Configure buttons on the Configure Sections screen allow the operator to select the preferred method for configuring boom or implement sections.

Configuring Section Labels

To customize the section labels displayed on the field computer, touch the 'Configure Section Labels' button. The Section Labeling screen will display.

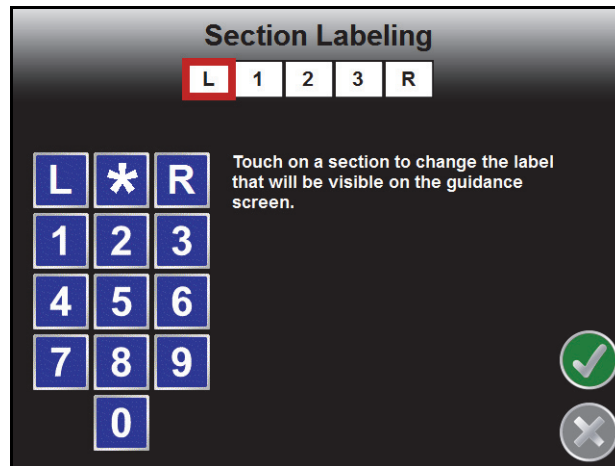

The currently configured section labels are displayed in boxes along the top of the screen. To begin configuring section labels:

1. Touch the box of the first section to relabel. A red box will appear around the selected section.
2. Use the displayed keypad to enter the new section label. The asterisk (*) label can be used for “skipped” sections or sections with a zero width value.
3. Repeat step 1 and step 2 until all sections have been configured with the desired label.
4. Touch the Accept  to return to the Configure Sections screen.

Section Mapping

The Envizio Pro field computer allows the operator to customize the section to switch mapping to the operator to quickly control multiple sections using a single switch. This feature also allows the operator to use a standard 10 section switch box to control an implement with more than 10 sections.

Note: *Version 1.30 is required on the Raven CAN switch box to manually map sections.*

Verify section mapping is configured correctly before starting a job.

Automatically Configure Sections

If sections of the boom or implement are aligned end-to-end along the swath midpoint, select 'Auto Configure.' The field computer will automatically configure section locations.

After the field computer has configured sections, section locations can be modified by touching the Manually Configure button.

Manually Configure Sections

If the boom or implement is not aligned end-to-end on the swath midpoint, the boom or implement sections will need to be manually configured.

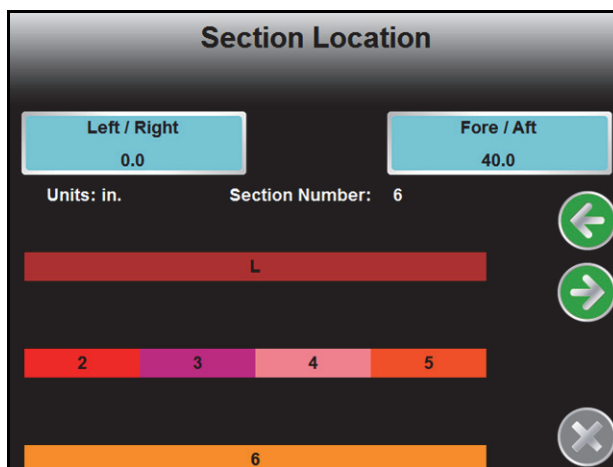

1. Select Manually Configure to begin locating boom or implement sections. The Section Location screen will be displayed. The currently entered offsets for the first section (if any) are displayed in the Left/Right and Fore/Aft buttons.



Note: The reference point for measuring the section left/right and fore/aft offsets depends upon the implement type selected prior to configuring the section configuration.

- **Self-propelled or mounted Implement** - The reference point is the antenna position. Offsets must be measured from the antenna to the midpoint of each section.
- **Trailed Implement** - The reference point is the implement pivot point, usually the center of the implement wheel base. Offsets must be measured from the implement pivot point to the midpoint of each section.
- **Trailed Implement with Tow Between** - The reference point is the rear hitch of the tow between implement. Offsets must be measured from the rear hitch to the midpoint of each section.

Review the *Offsets and Implement Type Selection* section on page 142 for details on measuring section offsets.

2. Touch the left/right button to enter a left or right offset for the first section. Enter a negative value if the center of the section is located to the left of the of the DGPS antenna.
3. Touch the fore/aft button to enter a fore or aft offset for the first section. Enter a negative value if the center of the section is located behind the DGPS antenna.
4. Touch the Next  icon and repeat steps 2 and 3 to continue programming individual section locations. When finished, touch the Next icon to return to the Configure Sections screen.
5. Touch the Accept  icon to return to the Section Configuration screen.

Profiles

Select the Profiles icon within the Vehicle submenu to select a previously created profile, or to save the current settings as a new profile.

Profiles save the following settings:

- GPS Antenna Height and Offsets
- Swath Width
- Section Widths and Configuration

Show All

The Show All icon in the upper, right corner of the screen displays the Tools Menu overview screen. Touch this icon to display the System, Vehicle, Computer, and GPS menus and the individual pages accessible in each menu on one screen. Touch the Show All icon to display the Tools Menu overview.

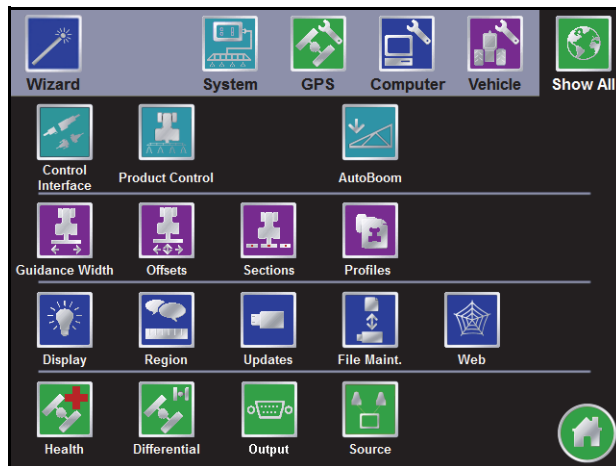

CHAPTER

8

Software Updates and File Maintenance

Overview

The Envizio Pro File Maintenance feature allows the operator to manage job related files right in the cab.

Raven recommends performing File Maintenance at least once a week and storing job related files on a home or office PC. Printable job reports may be created from files stored on a home or office PC.

Note: *The File Maintenance feature requires a specific file structure on the USB drive which the field computer uses to automatically transfer job files. The field computer will not be able to locate files if the file structure is modified. Make sure to save the files to the correct folder on the USB drive before attempting to load files back onto the Envizio Pro field computer.*

Depending upon the size of the completed job(s), file maintenance may take several minutes to complete. A typical job of 200 acres should take approximately 5 minutes. Larger fields and coverage maps with multiple sections or rate change zones could take significantly longer. Check the File Maintenance screen available memory display periodically and perform file maintenance as necessary.

Job related information transferred to a USB drive or stored on a PC may also be transferred back to the field computer as necessary for new job applications.

This chapter also contains detailed instructions for downloading and applying software updates for the Envizio Pro field computers.

File Maintenance

Coverage maps and field boundaries, saved A-B Lines, as well as zone maps can be transferred to a USB drive or deleted from memory using the File Maintenance feature.

File Outputs

When performing file maintenance, the field computer transfers job and file information in the following formats:

- Job data package, or .jdp files, for use with the Slingshot web service.
- Bitmap, or .bmp files, can be opened on nearly any computer operating system without special software.
- The shapefile format requires specialized software to view the shapefiles on a home or office PC. Shapefiles consist of four separate files, each with the same file name. A file with the .shp, .shx, .prj, and .dbf file extensions are all essential for the shapefile format to function correctly.

To save memory on the field computer, the Envizio Pro only generates (if selected) the printable bitmap and shapefile reports when file maintenance is performed. For this reason, actual memory requirements for the USB drive will be greater than the disk space used on the field computer internal memory.

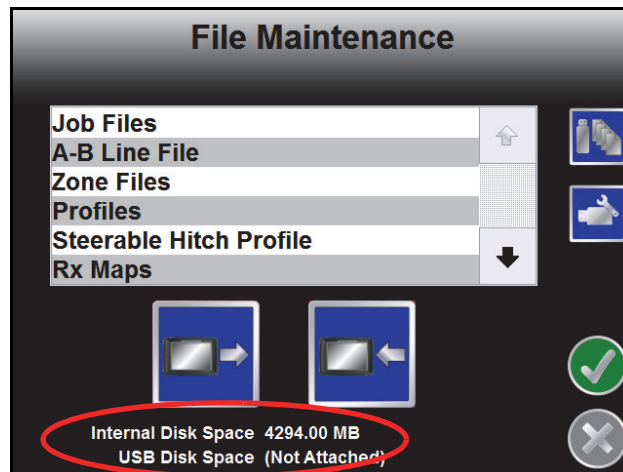

Available memory resources of the field computer and the connected USB drive are displayed at the bottom of the File Maintenance screen. It is recommended to use a USB flash drive with at least 512 MB.

Performing File Maintenance

1. Open the Tools menu and select the File Maintenance icon in the Computer Menu.

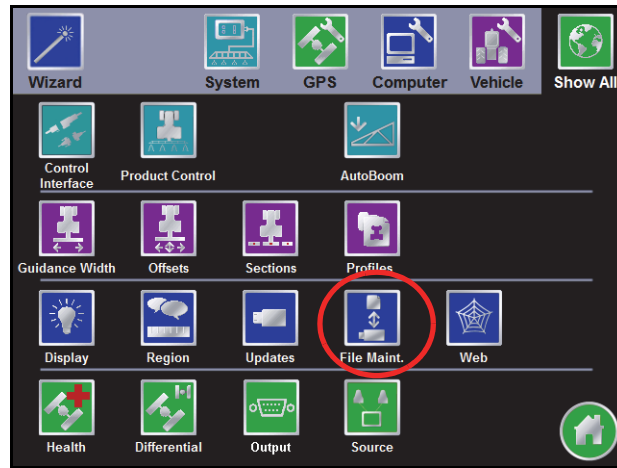

2. If the connected drive has not previously been used to transfer job files from the Envizio Pro, touch the icon along the right side of the screen to setup the required file structure.

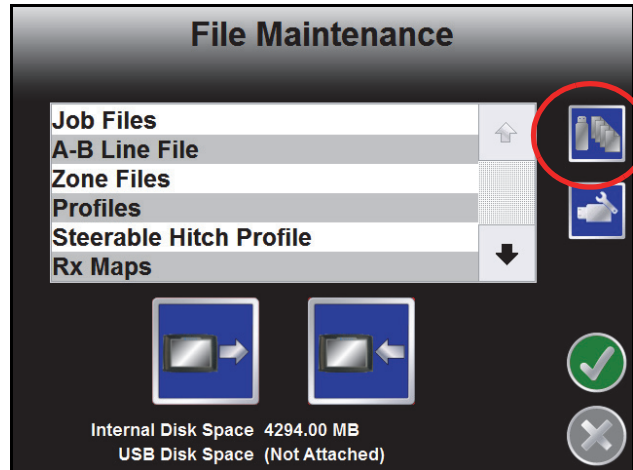

For more information regarding the file structure on the USB drive, refer to the *File Structure* section on page 158.

3. Select the type of file on which the file maintenance operation will be performed.



4. Press the Configure File Output icon.
5. Check the configuration setup.
 - Report: A report file includes rate, area covered, and other basic operation information.
 - Shapefile: records the geographic features (field boundaries, spray zones, etc).

- Slingshot: Selecting Slingshot creates a JDP report that will be uploaded to the Slingshot report website.

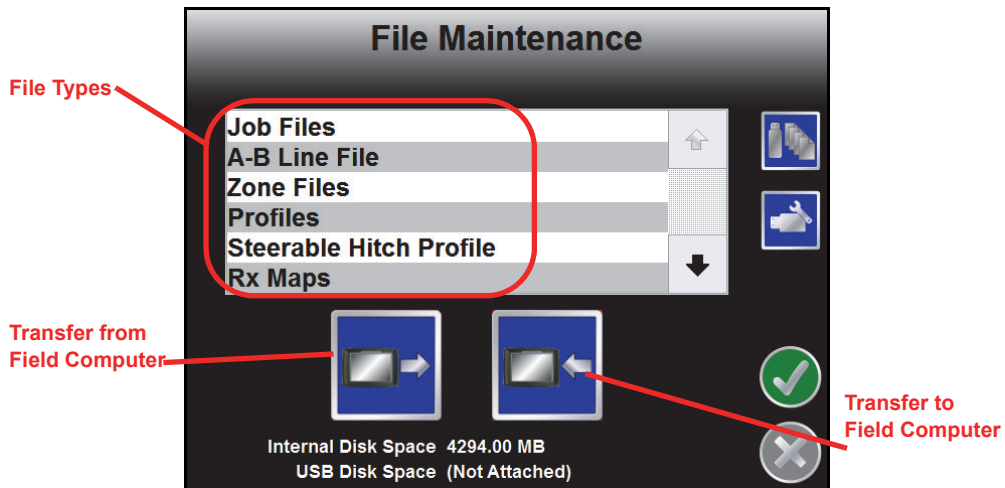
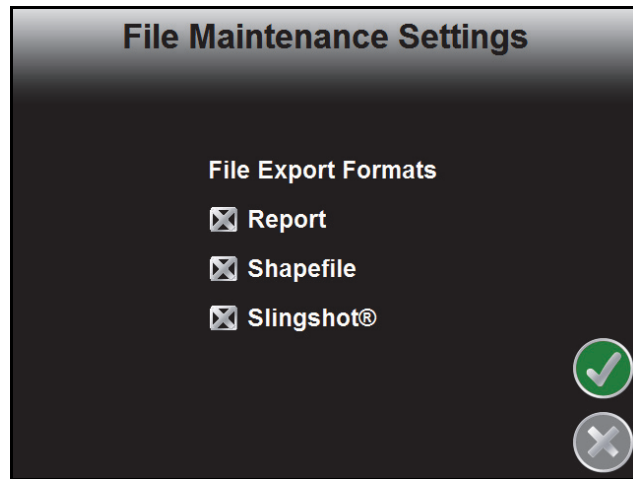

6. To begin working with the selected file type, touch the transfer to or transfer from field computer icon below the list of file types. For example, if the operator selects “Job Files” and the “from Field Computer,” the Job Files screen will display similar to the following:

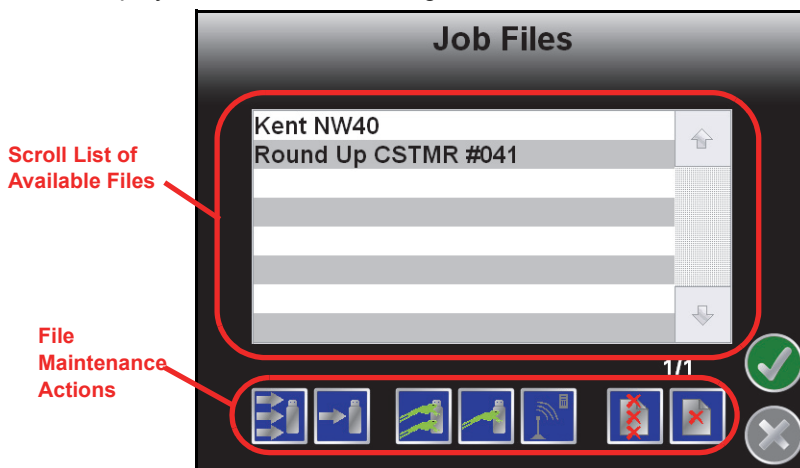

7. Use the following icons to perform the desired file maintenance actions:

Transfer From Field Computer



Configuration settings allows the user to select the file types that are exported from the field computer to the USB drive.



Select left icon to transfer a selected file to the connected USB flash drive or the right icon to transfer all files of the selected type currently saved on the field computer.



Select the left icon to export the Slingshot® data package for a selected job file to the connected USB flash drive or the right icon to export data packages for all job files currently stored on the field computer



Note: *Jobs exported to a USB flash drive using the SlingShot File type may be uploaded to the Slingshot web site using a home or office computer. Jobs exported using only the slingshot file type are not transferable to other Envizio Pro field computers.*

www.ravenslingshot.com



Select the left icon to delete a selected file from the field computer or the right icon to delete all files of the selected type currently saved on the field computer.



Note: *The Delete button will not affect any files on the flash drive. To remove files from the flash drive, use the PC's file browser (i.e. Windows Explorer) to remove, delete or copy files from the flash drive.*



Touch this icon to manually initiate upload of a selected file currently stored on the field computer via a Slingshot® Field Hub and available wireless connection.

Note: *Refer to Appendix C, Wireless Communications & Remote Service, for more information on transferring files using the Slingshot service.*

Transfer To Field Computer



Select the left icon to transfer a selected file to the field computer or the right icon to transfer all files of the selected type currently stored on the USB flash drive.



8. A confirmation screen will appear. Touch the Accept icon to proceed with the selected action or the Cancel icon to return to the File Maintenance screen without moving or deleting the selected files.
9. Once the action has been completed, touch the Accept icon again to return to the previous file type screen.

File Structure

When the File Structure is properly setup on the USB drive, the following directories and files are created and can be found on the flash drive when the flash drive is inserted into a home or office PC. Below is a list of files and folders that the field computer automatically creates on the USB drive:

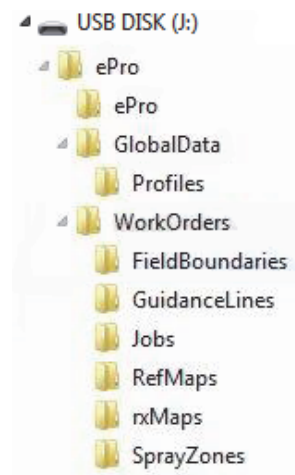

ePro Directory

The main directory containing all of the information transferred from the field computer. The ePro directory keeps all Envizio Pro files separated from other files which may be stored on the flash drive.

ePro

The ePro sub-folder contains files used by the field computer.

Global Data

Information not specific to individual job files is stored in the Global Data folder.

Profiles. The .pfl files contained within the Profiles folder contain configuration information for each profile. The field computer creates one .pfl file for each saved profile.

Profile files are used by the field computer OS and are not viewable.

Work Orders

Job information for each job transferred to the USB flash drive is stored in sub-folders contained within the folder labeled Work Orders.

Field Boundaries Folder. All shapefile boundaries (consisting of .shp, shx, .dbf files) saved to the field computer for use as boundary shapes will be stored in this folder.

Note: *The shapefile format consists of three separate files, each with the same file name. A file with the .shp, .shx, and a .dbf file extensions are all essential for the shapefile format to function correctly.*

Guidance Lines Folder. All transferred guidance paths are saved in the Guidance Lines folder. Line or path files have the .ab file extension. Guidance Line files are used by the field computer OS and are not viewable.

Jobs Folders. Each job transferred to the USB drive is stored in a separate folder within the jobs directory. Each job folder contains the Coverage, Shapefiles, and Reports sub-folders. A Slingshot folder may also display in the job folder if a Slingshot job data package is exported to the USB flash drive. To save memory on the field computer, the Envizio Pro only generates (if selected) the printable bitmap and shapefile reports when file maintenance is performed.

- The Coverage folder contains product coverage map files that have a .cov, .ini or .jdf extension. The field computer saves one coverage file for each product and each job. Coverage files are used by the field computer OS and are not viewable.
- The Shapefiles folder contains reports which the field computer generates during file maintenance. Each product applied during each job will have four separate files with .shp, .shx., .prj, and .dbf file extensions. Specialized software may be required to view the shapefile reports and each file is essential for the shapefile format to function correctly.
- The Reports folder contains bitmap reports which the field computer generates during file maintenance. Each product applied during each job will have a .bmp file. Bitmap reports are viewable on any computer.
- A Slingshot folder will be created for any job for which a job data package (*.jdp.zip) is exported to the USB flash drive. The Slingshot folder contains the files required to upload to a Slingshot viewer or user account to create reports or archive job information. Review the *Performing File Maintenance* section on page 155 for more information on exporting a job data package to a connected USB flash drive.

Reference (Ref) Maps Folder. Reference maps may be transferred to the field computer for use during harvest operations using the Raven SmartYield system. Reference maps are generally the coverage or as-planted maps with population, crop variety, or other information that may be used to compare crop inputs with the harvest yields for the same field.

To transfer a reference map onto the field computer:

1. A previous planting operation must be completed and completed job data package (.jdp) files transferred to the Slingshot web site.
Review the *Performing File Maintenance* section on page 155 for more information on exporting a job data package to a connected USB flash drive if a Slingshot Field Hub wireless subscription is not available.
2. Export the shapefiles from the completed job data package and copy these files into the “RefMaps” folder on the USB flash drive used with the Envizio Pro field computer.
3. When setting up a new job for the harvesting operation using SmartYield, select the appropriate reference map. Refer to the SmartYield Installation and Operation Manual for details on setting up a SmartYield job and loading the reference map files.

Rx Maps Folder. Prescription maps saved on the USB drive are located in the rxMaps folder. Each map must have the .shp, .shx. and .dbf files associated with the prescription map saved in this folder. Each file must have the same file name and each file extension is essential for the shapefile format to function correctly.

Special software may be required to view the rxMaps files.

Spray Zones Folder. Any zone maps transferred to the USB drive are stored in the spray zones folder. Files saved in this folder will have the .zone extension. Each zone map creates one .zone file.

Zone files are used by the field computer OS and are not viewable.

Updates

Software updates for the field computer will be available periodically from the Raven web site:

www.ravenhelp.com

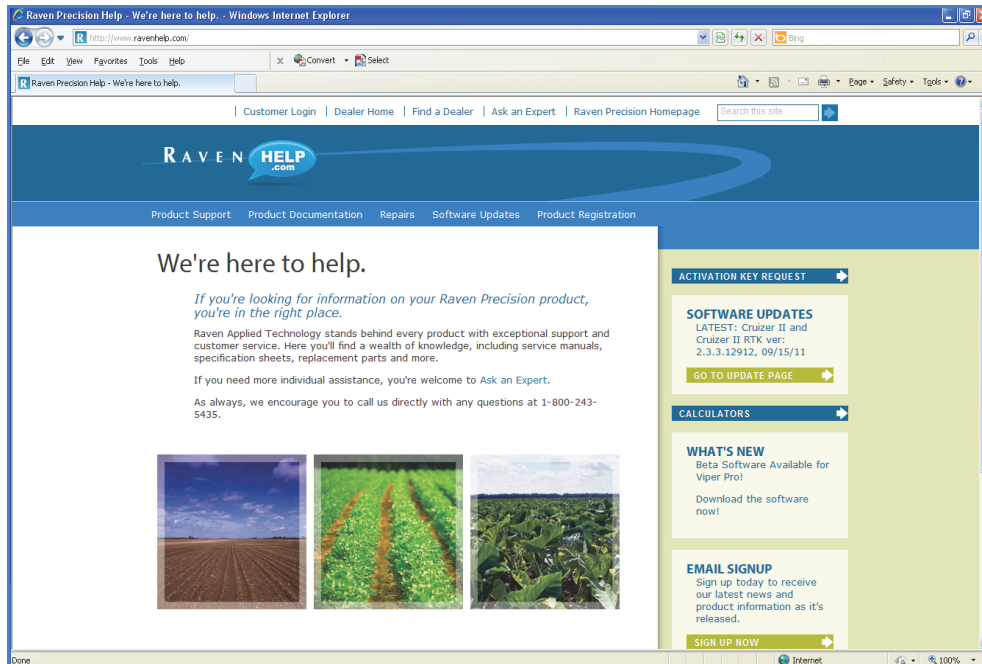

Note: Screens and prompts may display differently depending upon the version of operating system and the PC or laptop on which the field computer update is downloaded. For additional assistance, refer to the user help information for your specific browser or operating system.

1. Locate the latest Envizio Pro update.

Note: Verify that the correct product and software version is displayed at the top of the release notes before proceeding.

2. Select “View” to review the software release notes for the new software version. The release notes page may have important information about the software update and how updating the field computer may affect operation. Please read this page and be sure to follow any special instructions.
3. Select the “Download” link to begin downloading the software update.

If the following dialog displays, select the 'Save' option to save the files to a home or office computer.

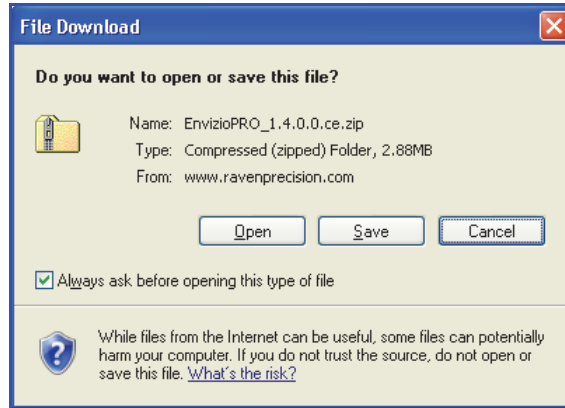

Download the update file to the desktop. The software must be “extracted” to the USB flash drive before loading onto the Envizio Pro field computer.

4. Insert the USB flash drive used with the field computer into an available USB port.
5. Double click on the .exe file and, if prompted, select “Run” to display self-extractor prompt.

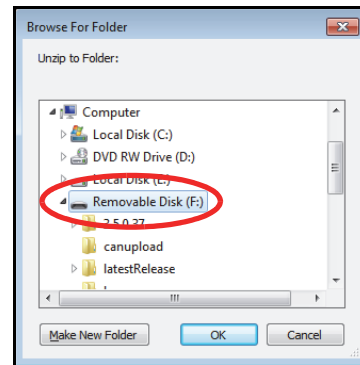
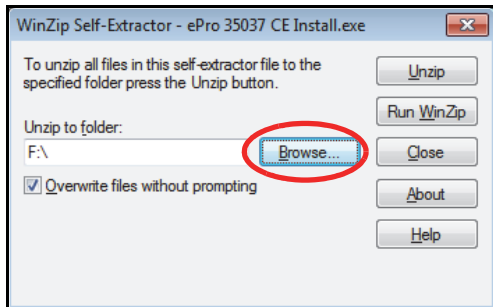

6. Select the “Browse...” button and then locate the flash drive in the Browse For Folder prompt.
7. Select the primary directory, or “root,” disk to extract the software update file.

To successfully update the Envizio Pro, the update files cannot be placed in any sub-folders or directories. The “Unzip to folder” field in the self-extractor prompt should display similar to the example above where “F:\” may be replaced by the drive letter assigned to the flash drive connected to your PC.

Applying Software Updates

Use the following procedure to apply software updates to the field computer.

1. Before inserting the flash drive into the Envizio Pro, switch the power on and wait for the field computer to power up.
2. From the Home screen, select the Tools menu icon and touch the Updates icon located in the Computer Menu.

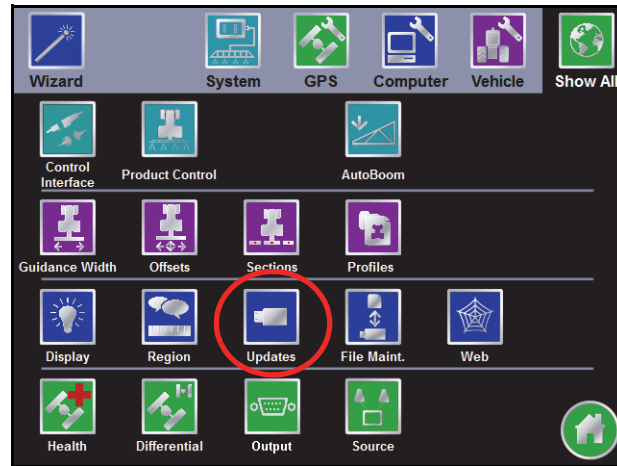

3. Insert the USB flash drive with the extracted software update into and available USB port on the field computer. A list of the available updates will appear on the screen.

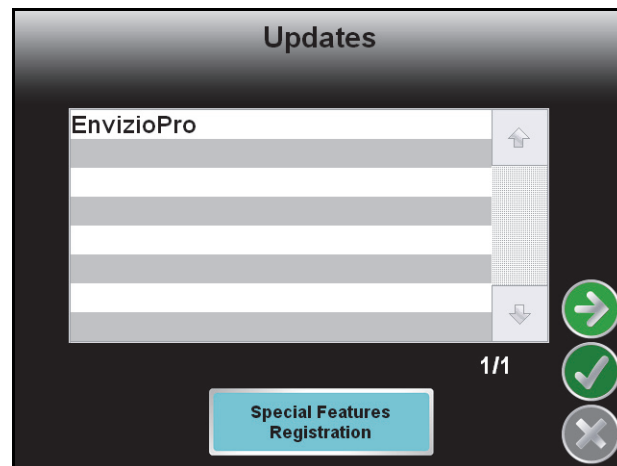

Important: The 'EnvizioPro_NoCanDemo' update is for demonstration purposes only. Do not select this option for normal operation applications.

4. Select the software update and touch the Next icon to begin updating the field computer.
5. Once the software update is finished, restart the field computer.

Introduction

AccuBoom is an automatic boom or implement section control feature that can be used in conjunction with the Envizio Pro field computers. The AccuBoom feature allows the field computer to automatically control boom or implement sections by referencing the as-applied or coverage map for each control channel. When AccuBoom detects a section entering an area where a product has previously been applied, AccuBoom will automatically turn that section off. When the section leaves the previously applied area, AccuBoom automatically turns the section back on.

Note: *Prior to using the AccuBoom feature with the Envizio Pro, the supporting hardware components must be purchased and installed for the specific machine. Contact a local Raven dealer for more information.*

CAN Switch Box

If a Raven CAN Switch Box, or the Raven Switch Pro™ switch box, is installed with the field computer, the section switches must be in the 'Accu' position to allow AccuBoom control for the assigned sections. If the section switches are in the 'On' or 'Off' position, the AccuBoom system will treat the section as manually overridden and will not automatically turn the section on or off based on previous application areas or field boundaries.

Note: *The CAN Switch Box must be used as the primary control interface for section, master or product control status. Refer to the Switch Pro Installation and Reference Guide for additional assistance with using the Switch Pro with the control system.*

Make sure to toggle the master switch to the off position when closing or exiting a job to avoid unintentional product application once the field computer or control console closes application management functions. It is also good practice to shut off product and section switches when the application system is not being used.

AccuBoom™ Setup

Prior to using the AccuBoom feature of the field computer, the AccuBoom node must be programmed for each product. To configure the AccuBoom feature from the Home screen:

1. Touch the Tools Menu icon.
2. Select the Product Control icon from the System menu.
3. Touch the AccuBoom button to display the AccuBoom Configuration screen.

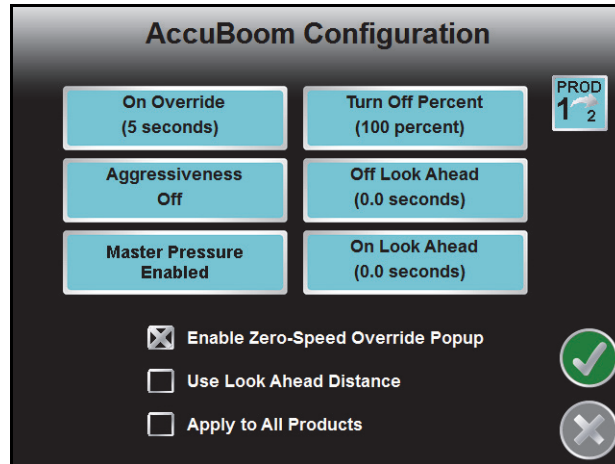

Note: *If the Function Disabled screen appears when the AccuBoom icon is selected, troubleshoot the AccuBoom node. See the CAN Troubleshooting section in Chapter 4, CAN Networking and Diagnostics or Chapter 11, Troubleshooting, for help troubleshooting the AccuBoom node.*

The following options are available on the AccuBoom Configuration screen for each available control channel on the CANbus system. Touch the cycle product icon in the upper, right corner of the screen to cycle to the next available control channel and configure the AccuBoom control feature for the next product controlled with the field computer.

On Override

Touch the On-Override button and use the up or down arrows to increase or decrease the override time for the AccuBoom feature.

Note: *The Override Sec value is not used if a SwitchPro or CAN switch box is installed on the CANbus. The On Override feature is useful when backing into corners during boundary spraying, to begin applying product from a complete stop, or to apply additional product to specific area of a field.*

To enable the override during an AccuBoom enabled job:

1. Toggle the 'Master' on the Raven CAN Switch Box to the Override position.
2. The override timer will display a countdown for the override time in the switch box icon location. When the override time expires, the switch box icon will return.

If a CAN switch box or Switch Pro is not installed with the control system, the on-screen switch box may be used to enable the override feature. To enable the override during an AccuBoom enabled job using the on-screen switch box:

1. Touch the on-screen switch box icon displayed in the lower, left corner of the Guidance screen.



The in job AccuBoom screen will be displayed.

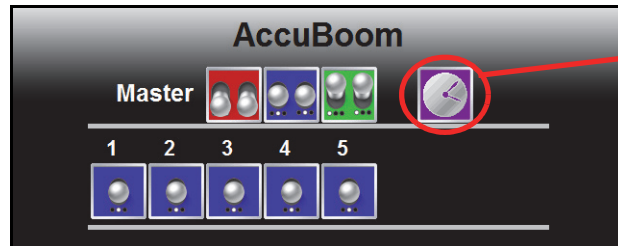

2. Touch the Override button. AccuBoom section control will toggle all sections on for the number of seconds configured for the override feature.

Aggressiveness

The aggressiveness setting adjusts the AccuBoom feature response for large implements or aggressive driving styles.

The look-ahead values set the amount of time ahead of the vehicle (based on vehicle speed) which the field computer will scan for zone boundaries or unapplied areas when turning sections on or off. By default, AccuBoom overrides any additional zone boundaries detected until the look-ahead time has passed. For example, if the turn-on look-ahead value is set to 5 seconds and AccuBoom detects an unapplied area 5 seconds ahead of a boom section, AccuBoom toggles that section on and will ignore subsequent commands to turn that section off until the section has entered the unapplied area.

For sections at the end of larger booms, or where sharp turns or aggressive maneuvering is necessary, this override may cause unexpected skips in coverage. The aggressiveness factor uses the user defined look-ahead values to adjust AccuBoom response for these driving styles and/or field areas requiring aggressive maneuvering when crossing zones. Higher aggressiveness settings will increase the override time for subsequent AccuBoom section control commands. To set the AccuBoom aggressiveness from the main screen:

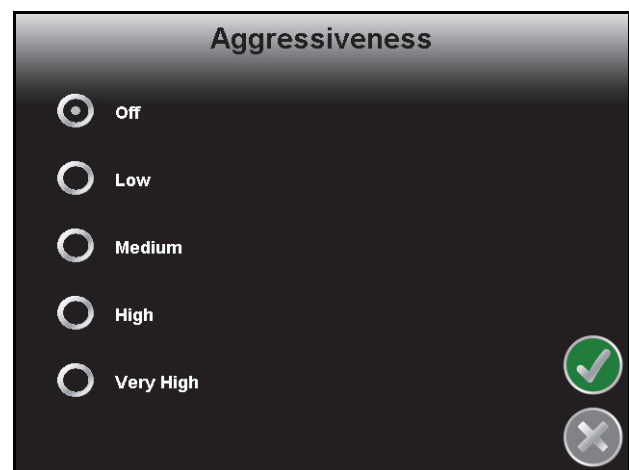

1. Touch the Tools Menu and select the AccuBoom icon located within the System menu.
2. Touch the Aggressiveness button.
3. Select the desired aggressiveness setting to match the operator driving style or requirements.
4. Touch the Accept icon to save the aggressiveness factor setting and return to the AccuBoom Configuration screen.

Master Pressure

If the product control node is capable of controlling the AccuBoom feature based upon boom pressure, the Master Pressure button will be displayed on the AccuBoom Configuration screen.

Touch the master pressure button to display the AccuBoom Master Pressure screen and configure the master pressure feature. This feature allows the field computer to enable or disable AccuBoom control based upon the liquid pressure at the booms.

Note: *The master pressure feature requires a pressure transducer to monitor the pressure in the main product line. Contact a local Raven dealer for details or to purchase an optional pressure transducer. Disable the master pressure feature if a pressure transducer is not installed with the CANbus system.*

On Pressure

Set the pressure at which the field computer will allow the AccuBoom feature to automatically control boom sections.

Since boom pressure may fluctuate slightly when sections activate, it is recommended to set this value above the minimum desired boom pressure to ensure adequate pressure to maintain the spray pattern.

Off Pressure

Set the pressure at which the field computer will shut off all AccuBoom controlled sections and disable automatic section control. All AccuBoom controlled sections will be overridden off until the boom pressure rises above the set 'On Pressure' value. If the boom pressure falls below the off pressure as sections are enabled when the on pressure setting is reached, reduce the off pressure value to allow the system to being application.

Note: *The 'On Override' feature will not override boom sections on if the boom pressure is below the 'Off Pressure' setting.*

Turn Off Percent

This value controls the percentage of a section that must cross a field or zone boundary, or enter a previously applied area, before AccuBoom will control that section. The default value is 100%.

Using the default setting, when 100% of a section crosses into a no-spray zone or previously applied area, AccuBoom will toggle the section off.

Note: *If the turn off percent value is set to 0%, sections will not turn off automatically.*

Look Ahead

Set the AccuBoom Look Ahead setting to the number of seconds (determined by speed) the field computer is allowed to scan in front of the current vehicle position for zone map features. The On and Off Look Ahead settings may help to compensate for the time required to open or close control valves based upon the zone map.

A non-zero “On” Look Ahead value allows AccuBoom to begin opening control valves while a non-zero “Off” Look Ahead will allow AccuBoom to begin closing valves.

Note: *Setting the Look Ahead values too high may cause the control valves to begin opening or closing too early. This may cause overlaps, skips, or undesirable product application in some areas. Generally, these settings should not exceed 5 seconds and a value between 1 to 2 seconds will yield the best results.*

Use Look Ahead Distance

Enable the Use Look Ahead Distance option on the AccuBoom Configuration screen to set look-ahead values in units of distance rather than time.

Note: *The vehicle must travel at a constant speed while using the look ahead distance.*

Enable Zero Speed Override Popup

Check the Enable Zero Speed Override Popup option to display the AccuBoom Popup screen during AccuBoom enabled jobs.

Enabling AccuBoom™

To use the AccuBoom feature with the product control system, AccuBoom must be enabled. AccuBoom cannot be enabled while a job is in progress. To Start or Resume a job with the AccuBoom feature enabled:

1. Select the Start Job icon on the Home screen.



2. Touch the AccuControl button on the Verify Settings screen (See Chapter 6, *Basic Operation*, for details on other settings and features enable on the Verify Settings screen).

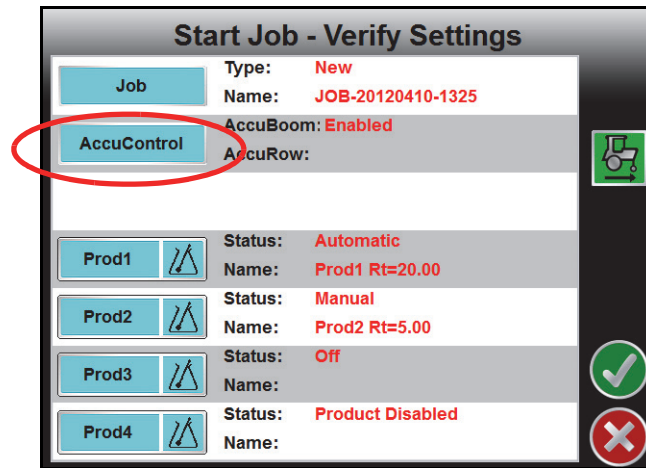

3. Select the Enable AccuBoom option to allow the AccuBoom feature to automatically control boom or implement sections. Leaving this option blank will disable AccuBoom. Once the Enable AccuBoom option is selected, the AccuBoom screen will appear similar to the following:

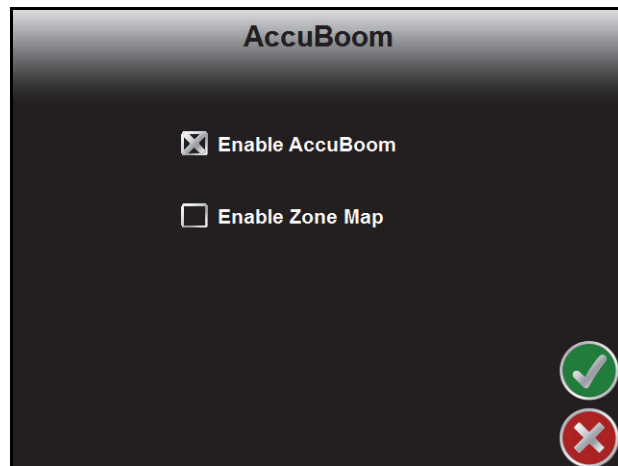

4. Leave the 'Enable Zone Map' option deselected to use Standard AccuBoom section control only. See the *AccuBoom™ Modes* section on page 169 for more information on the AccuBoom modes.

Touch the Accept icon and skip to step 7 if Standard AccuBoom is the desired mode of operation for this job. Proceed to step 6 to select a zone map for this job.

5. Select the 'Enable Zone Map' option to enable the zone mapping mode.

The Start Job - Select Zone Map screen is displayed when the 'Enable Zone Map' option is enabled.

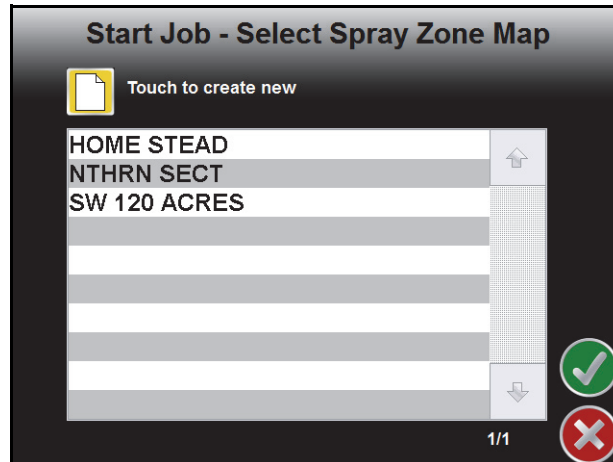

- a. Select the name of a previously saved zone map to use with this job and touch the Accept icon to return to the Start Job - Verify Settings screen.
- b. To create a new map, touch the Create New icon and enter a name for the zone map that will be created within the job.

Note: Zone maps and map file names cannot begin with a space.

6. Touch the Accept icon to save the entered name and return to the Verify Settings screen.
7. Verify the other available settings or features are setup correctly before beginning the job.

AccuBoom™ Modes

The available modes for operating AccuBoom are:

Standard AccuBoom™ Mode

In jobs using Standard AccuBoom mode, zone maps cannot be created or loaded. Automatic section control is based upon the coverage map only. As sections enter previously applied areas, AccuBoom will automatically turn that section Off. When the section leaves the previously applied area, AccuBoom automatically turns the section back On.

The standard field boundary tools are used while operating in Standard AccuBoom mode. Refer to the *Field Boundary* section on page 80 for information on the standard field boundary tools.

Zone maps cannot be loaded or created in the Standard AccuBoom mode. To use or create a spray zone map, be sure to select the 'Enable Zone Map' option during the Start Job - Verify Settings procedure. See the *Enabling AccuBoom™* section on page 167 for help enabling zone maps.

Zone Mapping Mode

Zone maps create features within a field which allow AccuBoom and the field computer to automatically shut off or turn on product application as the machine travels through the field. The field computer may be used to create and save AccuBoom zone maps for each field in which automatic section control is desired.

Spray Zones. In areas where product application is desired, a spray zone allows AccuBoom to turn on boom sections and the field computer to control application rates as normal.

No-Spray Zones. No-spray zones may be created and saved around any areas in which product application should be avoided, such as waterways, or around well heads. AccuBoom uses the spray zone map to control boom sections as the machine travels through the field.

For example, as the implement crosses into a no-spray zone, AccuBoom will automatically shut off any sections that enter the no-spray zone while other sections remain enabled. As the sections re-enter unapplied spray zones, AccuBoom will automatically toggle sections back on.

Field Boundaries. Field boundaries within an AccuBoom enabled job automatically create a zone map based upon the completed boundary. A field boundary recorded without the AccuBoom feature enabled can be converted to an AccuBoom field boundary later. See the *Loading a Field Boundary* section on page 172 for details.

Note: *A job file can be saved with any number of spray or no-spray zones, but a job file may only contain a single field boundary.*

Within the completed boundary, AccuBoom assigns the area as a normal spray zone. No-spray zones can be recorded later to edit the area within the field boundary. AccuBoom assigns a minimum of three boom or implement widths outside of the completed field boundary as a no-spray zone. The Envizio Pro will also disable section control features when the vehicle is outside of the recorded field boundary.

Note: *Even though the field computer automatically controls sections when the vehicle is outside of the field boundary, it is not recommended to approach nurse trucks or refilling stations while automatic section control is enabled. Toggle the vehicle master switch to keep AccuBoom from turning on sections unexpectedly.*

If the 'Enable Zone Map' option is not selected during the Start Job - Verify Settings process, AccuBoom will not assign spray/no-spray zones to completed field boundaries.

On-Screen Switch Box

If an optional automatic section control feature is enabled for the current job, the on-screen switch box icon will be displayed in the lower, left corner of the Guidance screen.



Note: The on-screen switch box is not available if a Raven CAN switch box or Switch Pro switch box is connected to the CANbus.

Touch this icon to access the section control feature screen to control individual sections or activate the feature override.

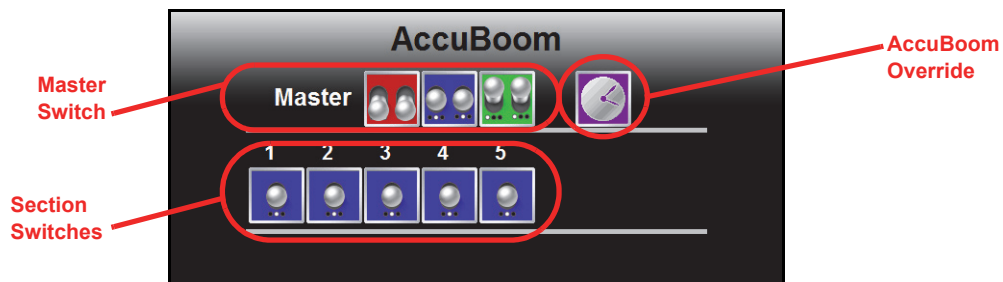

The AccuBoom screen displays the following icons to control sections:

Master Switch Control. Touch the master off, automatic or on icons to toggle all sections currently set to automatic control. Tapping the master switch indicator will toggle any sections currently in the automatic mode to the selected status. Tap the automatic mode will toggle those sections back to automatic while leaving any manually controlled sections to the assigned mode.

Double tap the master switch icon to toggle all section switches to the selected status.

Section Control Switches. Touch the individual section control switches to toggle individual sections or rows between the automatic, off or on.

AccuBoom Timed Override. Touch the timed override icon to override the AccuBoom feature on for the set override time. Refer to the *AccuBoom™ Setup* section on page 164 for more information on calibrating the AccuBoom feature and using the override.

Using Zone Maps

An AccuBoom zone map may contain numerous spray and no-spray zones for each field. Zone maps may be modified at any time using the available tools and features of the zone mapping mode. The following sections will cover various methods of using zone maps and field boundaries stored on the field computer.

Loading a Field Boundary

A field boundary recorded without the AccuBoom feature enabled may be loaded as an AccuBoom field boundary within a zone mapping enabled job. To load a standard field boundary into an AccuBoom enabled job:

1. Touch the Menu icon in the lower, right corner of the Guidance screen.
2. Select the Zone Mapping Tools icon.
3. Select the Load Field Boundary icon. A list of available field boundaries currently saved on the field computer will display.
4. Select the name of the desired field boundary and touch the Accept icon. The selected field boundary is displayed on the Guidance screen.

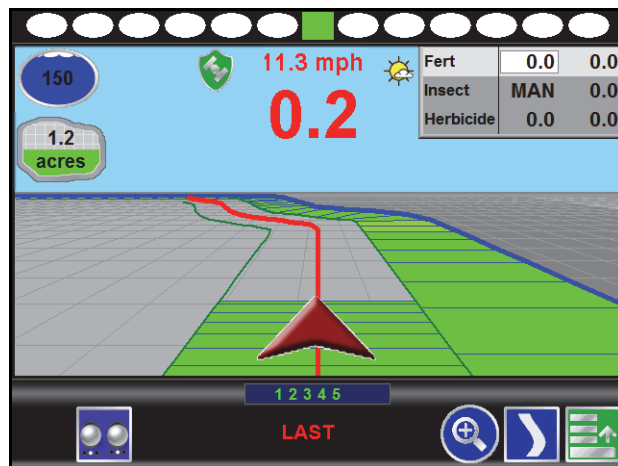

Note: Field boundaries created or exported by the Envizio Pro will be named using the job name or zone map name provided when the job was started. Shapefile boundaries may be renamed on a PC or laptop before importing the boundary onto the field computer.

AccuBoom™ Mapping Tools

The following tools are available via the Menu on the Guidance screen during an AccuBoom enabled job with zone mapping.



Select the zone mapping tools to display AccuBoom and zone map tools available for the current job. Tools displayed in this menu may only appear if certain map features are present within the current job. Read the descriptions of the following tools for more information regarding when the tool or feature is available.



While editing zone maps, the Home button is replaced with the Accept button. To save the currently displayed map and restore normal Menu tools, select the Accept button.



Touch the Record No-Spray Zone icon to begin recording points along a no-spray zone boundary. The area inside of the completed boundary will become a no-spray zone.



Touch the Record Spray Zone icon to begin recording points along a spray zone boundary. The area inside of the completed boundary will become a spray zone.



Touch the Record Field Boundary icon to create a new AccuBoom field boundary. With the zone mapping mode enabled, AccuBoom will assign a minimum of three implement widths outside of the completed boundary as a no-spray zone.

On-Screen Tools

While recording a zone map feature, the following icons will be displayed on the Guidance screen.

Pause

Select the Pause button displayed on the Guidance screen to temporarily interrupt recording the current zone map feature. This feature is useful if the vehicle course will move away from the desired boundary to refill a tank, etc.

Pause No-Spray Zone



Pause Spray Zone



Pause Field Boundary



Resume

While Paused, a Resume button will replace the Pause and End buttons on the Guidance screen. Touch this button to resume recording the paused zone feature.

Resume No-Spray Zone



Resume Spray Zone



Resume Field Boundary



Stop

When finished recording a Zone or Boundary, touch the Stop button to close Zone or Boundary.



Note: The field computer will draw a straight line from the starting point of the feature to the current vehicle location when closing the zone map feature.

Creating an AccuBoom™ Zone Map

The following is an example of recording an AccuBoom field boundary in the zone mapping mode. Other zone features may be recorded using the same procedure by using the buttons and tools as described in the *AccuBoom™ Mapping Tools* section on page 173.

1. On the Guidance screen, access the Menu and select the AccuBoom Boundary Tools icon.

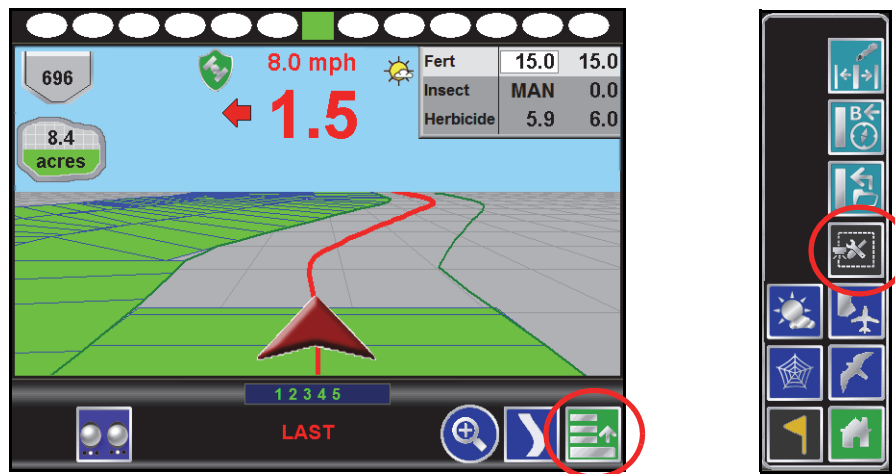

2. Select the Record Field Boundary button to begin recording a new AccuBoom field boundary.

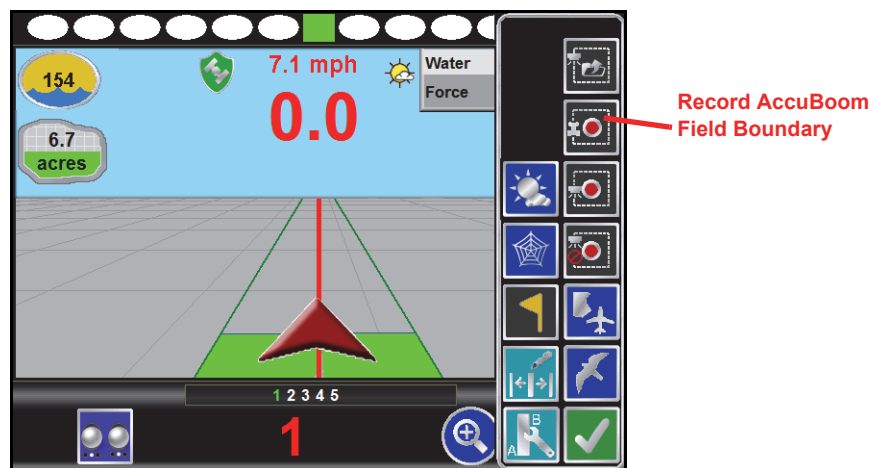

The Select Reference Point will display.

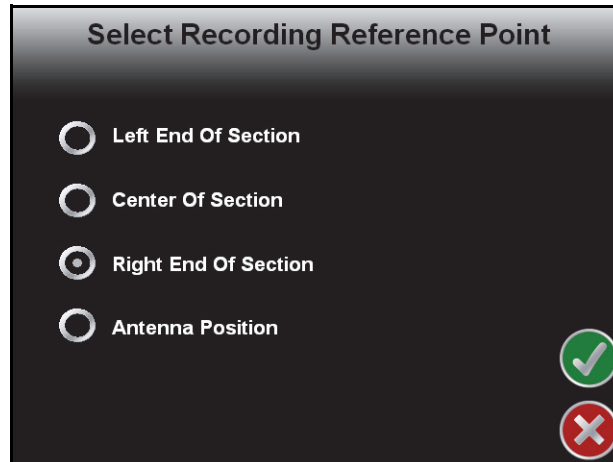

The Reference Point is the point on the vehicle where the field computer will record the selected feature boundary.

- Left and Right End of Section options set the Reference Point at the left or right end of the guidance width.
 - Center of Section sets the Reference Point at the center of the configured guidance width.
 - Antenna Position uses the left/right and fore/aft offset values to determine the DGPS antenna location.
3. To set the Reference Point, select the option that corresponds to the orientation of the vehicle with respect to the feature being recorded and then touch the Accept icon.
 4. The Guidance screen will re-appear and the field computer will begin recording the feature at the selected Reference Point. On the Guidance screen, a Pause and End icon appear for the feature currently being recorded.

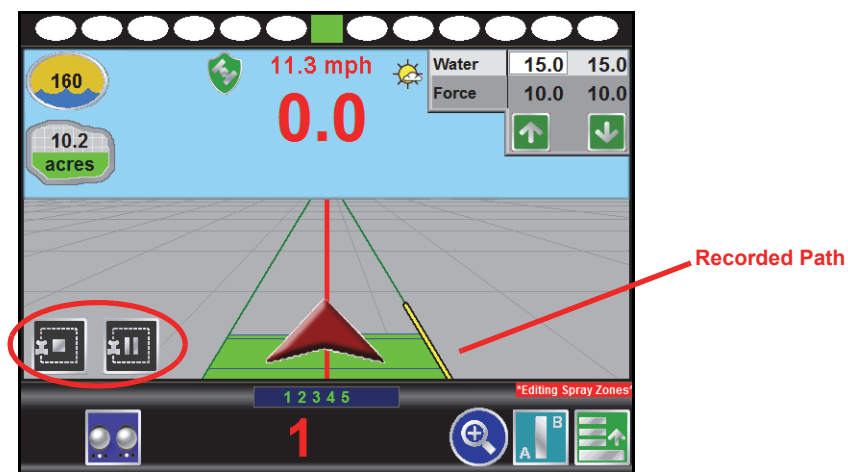

5. Begin driving along the boundary while keeping the Reference Point aligned with the field boundary. A yellow path will be created on screen to display the path recorded.
6. Touch the Stop button to finish recording the current feature on the AccuBoom map.

Note: The field computer will close the feature by drawing a straight line from the current vehicle location to the point where recording of the feature was started. Areas inside and outside of the feature will be treated accordingly.

- Repeat step 2 through step 6 for any additional features.
- When finished recording features for the AccuBoom map, select the Menu icon and then touch the Accept button to save the currently displayed AccuBoom map and close the AccuBoom tools menu.

Note: Zone features created while recording a field boundary will not appear until the Save and Close icon is selected from the AccuBoom Tools Menu.

AccuBoom™ Zone Map Examples

The following screens are examples of AccuBoom maps displayed on the field computer.

FIGURE 1. Field Review Mode While Recording a Boundary

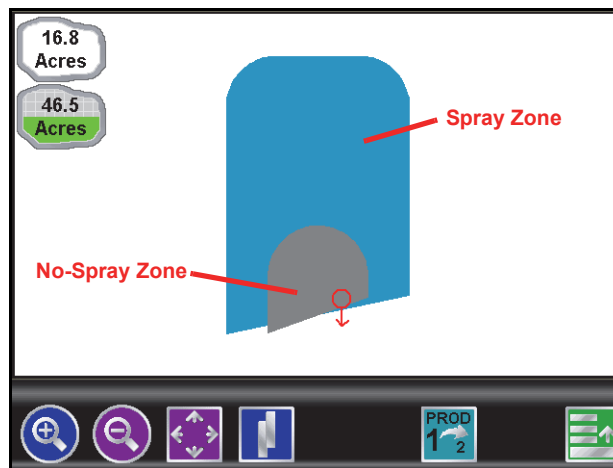

FIGURE 2. Field Review Mode with Completed AccuBoom™ Field Boundary and No-Spray Zone

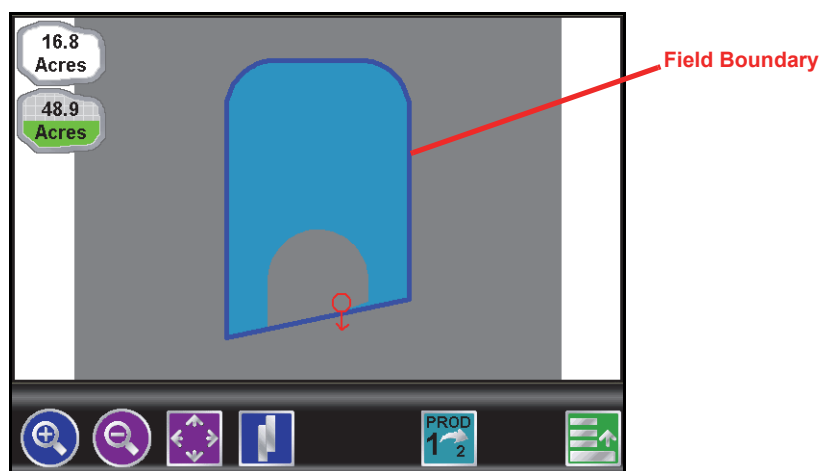

FIGURE 3. Guidance screen in Down Field View with Completed Field Boundary

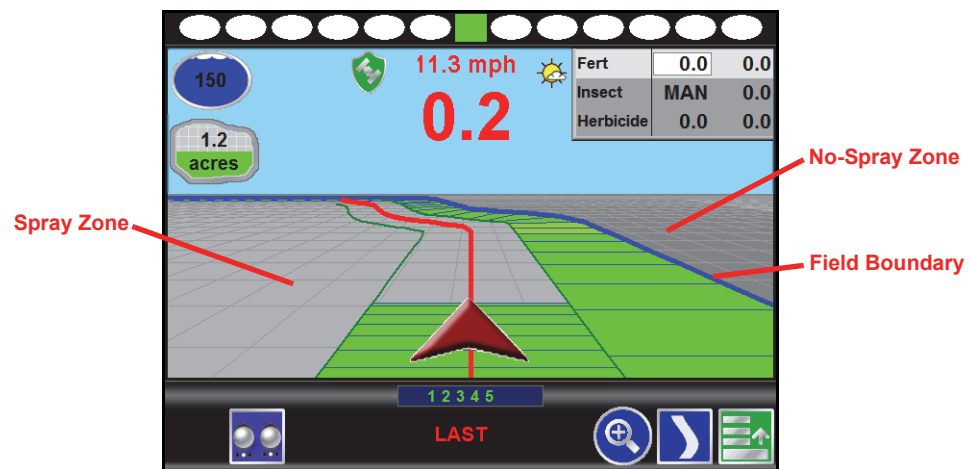
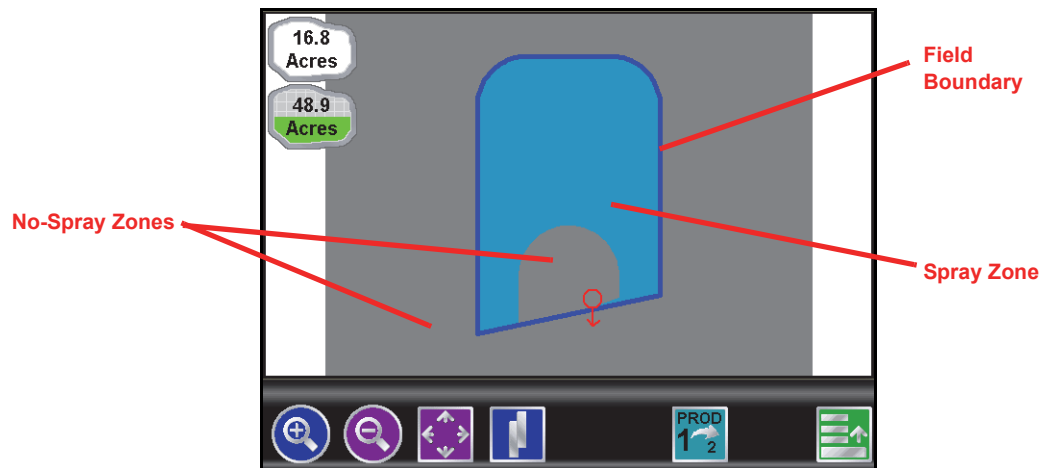

FIGURE 4. Field Review Mode with Completed AccuBoom™ Field Boundary and No-Spray Zone



Introduction

The AutoBoom feature, used in conjunction with an Envizio Pro, adjusts the height of the booms automatically. Using the machine's boom hydraulics, the AutoBoom parallel hydraulic system always keeps the hydraulic valves open, gently balancing the hydraulic cylinders and allowing the booms to raise or lower effortlessly.

The field computer and AutoBoom system must be calibrated and properly setup prior to using the AutoBoom feature with the Envizio Pro. See the calibration instructions specific to the Glide Series AutoBoom system for details on setting up the AutoBoom system.

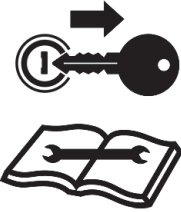
| | |
|---|---|
|  | NOTICE Read all safety requirements and precautions in the machine specific installation manual prior to operating a machine equipped with the AutoBoom feature. Failure to follow safety precautions may lead to damage to equipment, injury or death. |
|---|---|

Note: *If the Function Disabled screen appears when the AutoBoom icon is selected, troubleshoot the AutoBoom node. See Chapter 11, Troubleshooting or the CAN Troubleshooting section in Chapter 4, CAN Networking and Diagnostics, for help troubleshooting the node.*

There are two AutoBoom systems that can be controlled by the Envizio Pro:

PowerGlide Plus

PowerGlide Plus AutoBoom utilizes gauge wheels to maintain optimum boom height while state-of-the-art hydraulics are used to maintain constant hydraulic pressure in the lift cylinders. PowerGlide Plus systems are typically used in pre-emergent applications.

UltraGlide

UltraGlide AutoBoom replaces the gauge wheels with state-of-the-art ultrasonic sensors to measure the boom height above the ground. Since no part of the machine must come into contact with the ground or crop, UltraGlide systems are ideal for use in post-emergent as well as pre-emergent applications.

Note: *Terrain conditions as well as the machine's hydraulic system will dictate the actual speeds which may be achieved while applying with an Engaged AutoBoom system. Typically, rougher and more varied field terrain will require slower AutoBoom application speeds.*

AutoBoom[®] Operation

Once properly calibrated, operation of the AutoBoom feature with the Envizio Pro is as easy as toggling the feature on and enabling height control for each boom. AutoBoom must be both On and Enabled for each boom before the system will manage boom height. The field computer does not require an active job to enable the AutoBoom feature.

Status Display

During a job, the status of the AutoBoom system is displayed on the Guidance screen.

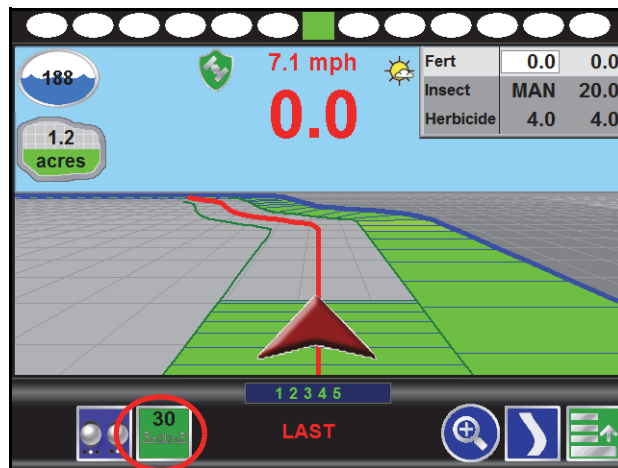

Touch the AutoBoom Status Display to view the main AutoBoom Settings screen.

Note: *If operating with an UltraGlide AutoBoom system, the set Sensor Height is displayed in the Status Display. If an optional center rack sensor is installed, the actual height of the center rack will be displayed in this area.*

AutoBoom® Indicators

The following sections offer examples of the AutoBoom status indicators which may be displayed on the Guidance screen during a job. The AutoBoom status display will appear differently depending on the capabilities of the AutoBoom system installed and connected to the field computer.

Standard AutoBoom

The following indicators may be displayed on the Guidance screen for a standard AutoBoom system:



The AutoBoom Off indicator displays when the AutoBoom feature is turned off. Boom height management is not enabled.



The AutoBoom On/Disabled indicator displays when the AutoBoom feature is On but boom height management is not enabled.



The AutoBoom On/Left Enabled indicator displays when AutoBoom is On and boom height management is only Enabled for the left boom. AutoBoom will not adjust the height of the right boom.



The AutoBoom On/Right Enabled indicator displays when AutoBoom is On and boom height management is only Enabled for the right boom. AutoBoom will not adjust the height of the left boom.



The AutoBoom On/Enabled indicator displays when AutoBoom is On and boom height management is Enabled for both booms.

AutoBoom Center Rack Control

For AutoBoom systems with the center rack control feature installed, the Guidance screen will also display the current status of the center rack.

For Example:



AutoBoom is on and the system will automatically control the height of the center rack. AutoBoom height control of the left and right booms is not enabled.



AutoBoom is on and the system will automatically control the height of the center rack and right boom. AutoBoom height control of the left boom is not enabled.



AutoBoom is on and the system will automatically control the height of the center rack and booms.

Troubleshooting Information

This chapter contains information on troubleshooting possible issues with the Envizio Pro control system. Please read through this chapter before contacting technical support, as many common issues and solutions are covered here.

General Issues

| Issue | Possible Cause | Solution |
|--|---|--|
| Field computer does not power up. | • No power to unit | • Check for +12V DC on pin 16 of the power cable. |
| | • Blown fuse | • Check for continuity in 10 amp fuse in power cable. |
| | • Poor ground | • Make sure that pin 1 is connected to the battery ground. |
| | • Unit is locked up | • Disconnect power for approximately 3 seconds and re-connect. |
| CAN node(s) not detected. | • No power to CAN node(s) | • Verify that there is 12 volt power and ground to the CAN node's logic power |
| | • Weak or dirty power to the CAN node(s) | • Verify that the 12 volt power to the CAN node is coming from the switch relay that is connected to the battery |
| | • Water in CAN node(s) | • Do not direct any pressure or wash stream directly at the CAN node(s) to prevent water and moisture from building up in the nodes. |
| | • Corrosion in CAN connections | • Disconnect and clean the CAN connections. |
| | • Broken cable to node | • Repair or replace cable. |
| | • Low power voltage | • Verify at least +10V DC at node. |
| Touch screen does not respond to touch | • Area touched does not include a selectable function | • Touch an area of the screen that contains a selectable function. |
| | • System is busy processing a previous request | • Wait for system to finish processing previous requests. |

| Issue | Possible Cause | Solution |
|---|--|--|
| Red DGPS Status indicator on the Home screen | • GPS cable is not connected | • Check the cable between the GPS receiver and the field computer. |
| | • No power to the GPS receiver | • Check power to the GPS receiver. |
| | • Incorrect port setting | • Make sure that the port settings on the field computer and the GPS receiver are the same. |
| | • Incorrect GPS source selected | • Verify that the correct GPS Source is selected. (Tools Menu>GPS menu>Source) |
| Product node(s) not detected. | • Wrong control type selected on the control interface screen. | • Verify the control type setting is correct for the control system. (Tools Menu>System menu>Control Interface). |
| | • Node connection issue in CAN system | • See the <i>CAN Troubleshooting</i> section on page 34 for CAN troubleshooting information. |
| Field computer does not completely power down | • The orange wire is connected directly to a 12V power source | • Do not connect the orange wire to a source of +12VDC. |
| Vehicle battery discharges overnight | • CAN nodes are wired directly to the battery | • Wire the CAN nodes through a relay or switched power source. |

Setup Issues

| Issue | Possible Cause | Solution |
|----------------------------------|---|--|
| Previous settings have been lost | <ul style="list-style-type: none"> • Settings data deleted from memory • Poor CAN connections | <ul style="list-style-type: none"> • Review Chapter 7, <i>Tools Menu</i> or Chapter 8, <i>Software Updates and File Maintenance</i>, for data information. • See the <i>CAN Troubleshooting</i> section on page 34 for more information. |

Job Issues

| Issue | Possible Cause | Solution |
|--|---|---|
| Section numbers do not turn green (remain white) | <ul style="list-style-type: none"> • Boom switches are turned off • AccuBoom enabled but machine not spraying • CAN is disconnected • The section is not set up properly • Wrong boom master option selected • Nodes not completely programmed • The section is disconnected | <ul style="list-style-type: none"> • Turn section and master switches on. • Move the machine out of the applied zone. • See the <i>CAN Troubleshooting</i> section on page 34 for more information. • Check the section setup in the Boom Sections screen of the Vehicle menu. • Verify the boom master option setting is correct for the control system. (Tools Menu>System menu>Control Interface) • Check node calibration and ensure all settings have been completed. • Check the connection and wiring to the boom or implement. |
| AccuBoom with Raven serial console, sections will not turn off | • Console section switches are in the 'On' position | • Section switches on Raven serial console must be in the 'Off' position. |

| Issue | Possible Cause | Solution |
|--|---|--|
| CAN AccuBoom will not turn on | <ul style="list-style-type: none"> Section switches are in the 'Off' position | <ul style="list-style-type: none"> Section switches for CAN AccuBoom must be in the 'On' position. |
| Date and time are incorrect (Default job name on the Verify Settings screen shows incorrect date and time) | <ul style="list-style-type: none"> No GPS No GPS RMC or ZDA Incorrect time zone selected | <ul style="list-style-type: none"> Make sure that the GPS receiver is operating properly and that the DGPS Status indicator displays as a green icon in the upper left corner of the Home screen. Check the GPS receiver to make sure the RMC or ZDA string is selected. Verify the settings on the Time Zone Settings screen are correct (Tools Menu>Computer menu>Time Zone). |

Coverage Map Issues

| Issue | Possible Cause | Solution |
|--------------------------------|--|---|
| Gaps displayed in coverage map | <ul style="list-style-type: none"> Section widths not set correctly Guidance and section width not the same | <ul style="list-style-type: none"> Check sections widths and section center values. Set guidance width and section width to the same value. |
| Cannot achieve target rate | <ul style="list-style-type: none"> Driving too fast for vehicle Calibration numbers incorrect Speed calibration incorrect | <ul style="list-style-type: none"> Speed may exceed capabilities of the vehicle to deliver product. Slow down or configure the vehicle to supply a higher amount of product. Check and adjust the calibration settings and values. Check and adjust the speed calibration setting. |

Error Messages

This section contains information regarding possible error messages displayed on the field computer and troubleshooting procedures.

Job Error Messages

| Issue | Possible Cause | Solution |
|-----------------------------------|----------------|------------------------------|
| AutoBoom node has gone off line | | Refer to CAN Troubleshooting |
| AccuBoom node has gone off line | | Refer to CAN Troubleshooting |
| Boom sense node has gone off line | | Refer to CAN Troubleshooting |
| No CAN nodes have been found | | Refer to CAN Troubleshooting |

GPS Error Messages

| Issue | Possible Cause | Solution |
|------------------------|--|--|
| Guidance Not Available | <ul style="list-style-type: none"> Displays when starting a job without a GPS signal | <ul style="list-style-type: none"> Make sure a GPS receiver is connected to the field computer and that the receiver is powered up, then select Auto-Detect. Make sure the correct GPS Source is selected (Tools Menu>GPS menu>Source) |
| No Differential | <ul style="list-style-type: none"> Differential GPS has not been detected by the field computer | <ul style="list-style-type: none"> Check the GPS receiver to make sure that it has the differential correction function. Contact the manufacturer for additional information. |
| No GPS | <ul style="list-style-type: none"> Field computer does not detect a GPS signal | <ul style="list-style-type: none"> Make sure that the GPS receiver is turned on and receiving a signal. Make sure that the port setting for the field computer and the GPS receiver match. Make sure that the required NMEA messages are turned on in the GPS receiver. |
| High HDOP | <ul style="list-style-type: none"> Satellite constellation issue | <ul style="list-style-type: none"> There is no issue with the DGPS system or cabling. Wait for the constellation issue to resolve before continuing job. |

CAN Troubleshooting

Although the control algorithm is located within the CAN node, all of the same troubleshooting techniques used in a traditional hard-wired system still apply to a CAN system. CAN allows for modularization of the control system, but the behavior of the system remains the same. Flow and speed sensors, as well as the control valve and boom valves, are used in the same fashion.

Refer to the Raven CANbus Network Installation Manual for detailed troubleshooting procedures and information.

APPENDIX

A

Calculating the Calibration Values

Speed Cal

Raven industries recommends the following values for the initial speed cal:

| Sensor Type Setting | Used with | Recommended Speed Cal Values | |
|---------------------|--------------------------------|------------------------------|--------|
| | | English | Metric |
| Radar/GPS | External Raven GPS Receiver | 785 | 199 |
| | Internal DGPS Receiver | 812 | 206 |
| | GPS Speed over CANbus | 1000 | 1000 |
| | Raven Radar | 598 | 152 |
| Wheel | Wheel Magnets | 1000 | 254 |
| | Speedometer Drive Speed Sensor | 612 | 155 |

These values are usually a good starting point and will generally yield adequate results; however, the speed cal should still be refined for each vehicle.

Note: *The GPS speed over CANbus feature is only available with specific Raven speed sense nodes. This feature utilizes NMEA speed over ground data transmitted over the CAN network which eliminates the need for a separate, external speed sensor.*



NOTICE

When using the GPS speed over CANbus feature, no tuning or adjustment is necessary or recommended to the speed cal value. Losing GPS signal for more than a second will also result in loss of the CAN speed signal which may affect product application in progress.

1. Make sure any section switches are turned OFF before powering the console ON.
2. In the System menu, touch the Product Control icon and touch the Speed button.
3. Touch the Distance button and then reset the odometer display to "0" using the keypad.

Appendix A

4. Drive 1 mile [1 kilometer]. The field computer will measure the distance driven using the original (or last programmed) speed cal.

Note: *Accelerate and decelerate slowly. To achieve the most accurate calibration, do not use the vehicle odometer or the field computer distance display to measure the actual distance driven. Use section lines or highway markers to determine the actual distance.*

5. At the end of the driven distance, view the distance display again and record the value.
 - a. The field computer distance should read a value of approximately 5280 [1000]. If the display reads between 5260-5300 [990-1010], the default value of 598 [152] is accurate for the speed cal value.
 - b. If the distance displayed is not between 5260-5300 calculate the speed cal with the formula:

$$CSC = \frac{OSC \times 5280}{D}$$

where CSC = Corrected Speed Cal, OSC = Old Speed Cal (speed cal number used to drive the test distance) and D = the field computer Distance reading. Round to the nearest whole number.

For Example:

Assume that the field computer odometer reads 5000 [980] after a known 1 mile distance has been driven using an initial speed cal value of 598 [152].

$$CSC = \frac{598 \times 5280}{5000} = 631.48$$

or

$$CSC = \frac{[152] \times [1000]}{[980]} = [155]$$

The Corrected Speed Cal value is 631 [155].

6. Touch the Speed button and use the keypad to enter the new value as the speed cal.
7. Verify the new speed cal derived in step 5 by repeating step 2 through step 4.

Wheel Drive Speed Sensor

1. Mark the tire on which the speed sensor is installed using chalk or a piece of tape as shown below.
2. Mark the corresponding spot on the ground.
3. Count 10 full revolutions of the wheel while traveling in a straight path. The mark must stop with the chalk or tape in the same orientation that it began at the starting point.

FIGURE 1. Calculating the Speed Cal with a Wheel Magnet Speed Sensor System

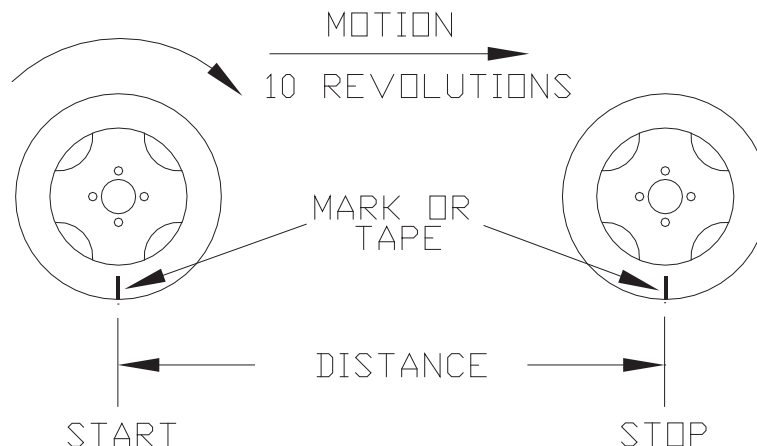

4. Mark the stopping point and measure the distance between the starting and stopping marks on the ground in inches [dm]. Round to the nearest whole number.

Note: *This measurement is critical to the performance of the console. Measure Carefully. Be sure tire is properly inflated before measuring. If possible, measurements should be made in the type of soil in which the vehicle will be operating. Tire circumference will vary when measured in soft or hard packed soil. For best results, measure several times and average the results.*

5. Enter this measurement as the new speed cal.

Adjusting for Additional Magnets

Typically, four magnets are used with the wheel drive speed sensor. However, to ensure accurate speed readings for large tires and very low speed applications, additional wheel magnets may be necessary. Any even number of magnets may be used as long as they are of alternating color and equally spaced. After calculating the speed cal, this number must be adjusted according to the number of magnets installed using the following formula:

$$\frac{4}{NM} \times D = ADJ$$

where ADJ = Adjusted Speed Cal, NM = Number of Magnets used and D = the Distance Measured.

For Example:

The distance measured between starting and stopping marks is 1200 and six magnets are installed.

$$\frac{4}{6} \times 1200 = 800$$

The Adjusted Speed Cal is 800.

Speedometer Drive Speed Sensor

1. In the System menu, touch the Product Control icon and then select Speed. Touch the Distance button and use the keypad to enter "0" as the distance displayed on the field computer.
2. Touch the Speed Cal button and use the keypad to enter a speed cal value of 612 [155].
3. Drive 1 mile [1 km]. The field computer will measure the distance driven using the speed cal value of 612.

Note: *Accelerate and decelerate slowly. To achieve the most accurate calibration, do not use the vehicle odometer or the field computer distance display to measure the actual distance driven. Use section lines or highway markers to determine the actual distance.*

4. Touch the Distance button.
 - a. The field computer odometer should display a value of approximately 5280 [1000]. If it reads between 5200-5350 [990-1010], the speed cal for the vehicle is 612 [155].
 - b. If the field computer odometer displays any other value, perform the following calculation:

$$\frac{OSC \times D_A}{D_o} = CSC$$

where OSC = Old Speed Cal, DA = Actual Distance traveled, Do = the field computer odometer Distance, and CSC = the Corrected Speed Cal. Round to the nearest whole number.

For Example:

Speed Cal = 612 [155]
 Actual Distance = 5280 [1000]
 Field computer odometer reading = 5000 [980]

English Units:

$$\frac{612 \times 5280}{5000} = 646.3$$

Metric Units:

$$\frac{[155] \times [1000]}{[980]} = [158.1]$$

The Corrected Speed Cal value is 646 [158].

5. Touch the Speed button and use the keypad to enter the Corrected Speed Cal. To verify the corrected speed cal calculated above:
 - a. Re-zero the distance display as in step 1.
 - b. Repeat step 3 and step 4. If the field computer odometer reading still does not match the distance driven, use the new values and redo the calculation and repeat step 5.

Liquid Applications

Use the following formulas to help calculate the boom or implement section widths for either broadcast or band applications.

Boom Cal

For liquid sprayers, the boom cal value is the width of the individual boom sections

Calculate the width of each section by measuring the spacing between spray tips in inches [cm] and then multiplying by the number of tips in each boom section

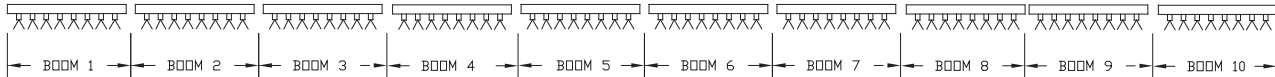

For Example:

20 tips in a section with spacing of 40 inches would yield:

$$20 \times 40 = 800 = SW$$

or a Section Width of 800 inches (approximately 67 feet). Enter 800 as the width for this section.

Band Spraying Adjustment

To calculate the adjusted applied rate for band spraying applications, use the following formula:

$$\frac{BR \times BW}{S} = AR$$

Where BR = the Broadcast Rate, BW = the band width, S = the spacing between the tips and AR = the Adjusted Rate for band spraying.

For Example:

If the Broadcast Rate is 20 GPA [200 L/ha], the band width is 14 inches [40 cm] and the tip spacing is 40 inches [100 cm]:

$$\frac{20 \times 14}{40} = 7$$

or

$$\frac{[200] \times [40]}{[100]} = [80]$$

Therefore, the adjusted rate is 7 gallons per acre or 80 liters per hectare.



Meter Cal

The flow meter calibration number can be found on the tag attached to each flow meter. Copy the information from the tag for future reference as the tags may fade or be lost during equipment operation.

Note: Refer to the *Verifying Flow Rate Limits* section on page 196 to verify that the desired flow rate is within the range specified for the installed flow meter.

Flow Meter Service and Maintenance

Periodic maintenance of the flow meter may help to extend the effective service life of the flow meter or internal components. If the flow meter does not register the applied product volume properly, the following steps will be necessary to service the flow meter:

| | |
|---|--|
|  | <div style="background-color: #e67e22; color: white; padding: 5px; text-align: center;">  WARNING </div> <p>Exposure to agricultural chemicals may be harmful or fatal. Thoroughly bleed and flush the application system lines prior to disassembling fittings, hoses and the flow meter.</p> <p>If the flow meter is used for applying anhydrous ammonia, bleed the nurse tank hose and flush the system with water before maintaining the flow meter.</p> |
|---|--|

The following procedure should be performed more frequently if the flow meter is used with harsh chemicals or in anhydrous ammonia.

1. Remove the flow meter from the application system and flush with clean water.

Appendix A

2. If necessary, dismantle the flow meter housing.
3. Remove the turbine hub and turbine from the flow meter.
4. Clean the turbine hub and turbine and remove any metal filings or other foreign materials such as wettable powders.
5. Check the turbine blades for wear or damage. Refer to the flow meter replacement parts sheet provided with the flow meter and replace the turbine as necessary.
6. While holding the turbine hub, spin the turbine. The turbine should spin freely with very little drag within the turbine hub. Refer to the flow meter replacement parts sheet provided with the flow meter and replace the turbine hub/turbine assembly as necessary.
7. Reassemble the flow meter.
8. Using a low pressure jet of air (5 PSI [34 kPa]), verify that the turbine still spins freely after reassembly. If the turbine drags or does not move, loosen the hex stud on the bottom of the turbine hub 1/16 turn until the turbine spins freely.
9. If the flow meter continues to provide inaccurate product volumes, refer to the *Flow Meter/Encoder Extension Cable* section on page 204.

Flow Meter Recalibration

The calibration value for the specific flow meter is printed on the tag attached to the flow meter and will typically provide accurate metering of product application. The following procedure may be used to check the meter calibration or recalibrate the flow meter.

Note: *Performing routine maintenance is recommended to help extend the service life and accuracy of the flow meter. Review the Flow Meter Service and Maintenance section on page 191 to service the flow meter as necessary.*

Before calibrating the flow meter:

1. It is recommended to perform the flow meter calibration with clean water only. Clean out the supply tank and flush the product lines with clean water. Refill the tank with clean water.
2. On the field computer, verify any active jobs are closed.
3. Toggle all boom section switches and the master section switch to the off position.
4. Disconnect one of the section product lines near the spray tips.
5. Set up a calibrated catch container (i.e. 5 gallon [19 L] bucket and place the disconnected end of the product line in the container.

To recalibrate the flow meter:

1. On the field computer Home screen, touch the Tools Menu icon.
2. Select the Product Control icon from the System menu.
3. On the Product Control Configuration screen, touch the Calibration Settings button.
4. Select the Meter Cal value and use the on-screen keypad to enter a value of 10 [38].
5. Touch the Accept icon until the Product Control Configuration screen is displayed.
6. Touch the Volume/Area Settings button.
7. Touch the Total Volume button and use the on-screen keypad to enter a value of 0.
8. Touch the Accept icon to return to the Volume/Area Settings screen.
9. While monitoring the Total Volume on the screen and the container, toggle the master switch and the appropriate section switch to the on position.
10. Dispense exactly 10 gallons [38 L] through the flow meter as measured by the calibrated catch container.

Important: *Do not rely on graduation markings/numbers molded into the applicator tank.*

11. Toggle the section or master switch off.
12. Read the value displayed on the field computer Total Volume button. This value should be within $\pm 3\%$ of the meter cal value printed on the flow meter tag.
13. To confirm accuracy, reset the Total Volume to 0 and repeat the above process several times. Always 'zero out' the Total Volume display before toggling the section switch on.

Note: *The above process is usually sufficient to check the flow meter calibration. For best results, set the Meter Cal value to 100 [378] and repeat the above procedure to dispense exactly 100 gallons [378 L] through the flow meter.*

To verify the flow meter calibration:

1. Fill the applicator tank with a predetermined volume of liquid (i.e. 250 gallons [946 L]).

Important: *Do not rely on graduation markings/numbers molded into the applicator tank.*

2. On the field computer Home screen, touch the Tools Menu icon.
3. Select the Product Control icon from the System menu.
4. On the Product Control Configuration screen, touch the Volume/Area Settings button.
5. Use the on-screen keypad to enter a value of 0 and touch the Accept icon.
6. Empty the applicator tank under normal operating conditions.
7. Return to the Total Volume displayed on the field computer and read the new value. The total volume value should match the known volume ($\pm 3\%$) used to fill the applicator tank.
8. If the total volume value displayed differs from the known volume by greater than 3%, use the following formula

$$\frac{MC \times Vm}{Vk} = CMC$$

Where MC = the Meter Cal value used during the test, Vm = the Volume measured by the field computer, Vk = the known Volume in the applicator tank and CMC = the Corrected Meter Cal.

For Example:

A set meter cal of 720 [190] is used to dispense 250 gallons [946 L] through the flow meter. At the end of the test, the field computer reads a measured volume of 260 gallons [984 L]:

$$\frac{720 \times 260}{250} = 749$$

or

$$\frac{[190] \times [984]}{[946]} = [198]$$

Therefore, the corrected meter cal is 749 [198].

9. Enter the corrected meter cal value before resuming application.

Valve Cal

Note: If the dual loop control feature is enabled, the valve cal value will be replaced by the flow cal value.

To ensure that the proper amount of product is being applied, the valve cal must be programmed for the type of control valve(s) connected to the control system. The field computer uses the calibration number to adjust the response time of the control valve motor to changes in the vehicle speed.

The following control valve calibration numbers are recommended for the valves listed:

| Control Valve Type | Valve Cal |
|---------------------------------|-----------|
| Standard (C-SD) | 2123 |
| Fast (C-F) or Fast Close (C-FC) | 743 |
| PWM (C-P) or PWM Close (C-PC) | 43 |

Each digit in the calibration number corresponds to a specific function of the valve. The following functions apply to the digits in the valve calibration number:

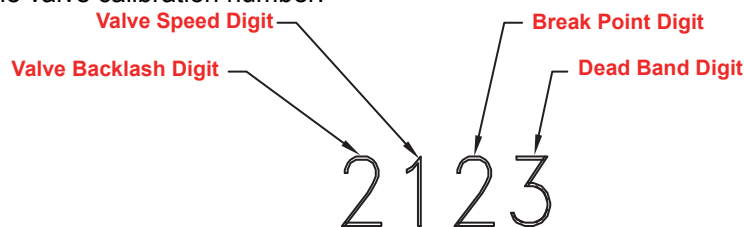

Valve Backlash Digit

This value controls the time of the first correction pulse after detecting a change in correction direction. The values range from 1 to 9, where 1 is for a short pulse and 9 is for a long pulse.

Note: The backlash digit is not used with a fast, fast close, PWM, PWM close or standard motor control valve.

Valve Speed Digit

This value controls the response time of the control valve motor. If the valve speed setting is too fast, the valve will over correct and the system can start to oscillate. The following valves have specific values:

- Standard Control Valve: This valve has a range of values from 1 to 9, with 1 being slow and 9 being fast.
- Fast and Fast Close Control Valve: These valves have a range of values from 0 to 9, with 0 for fast and 9 for slow.

Note: The speed digit is not used with a PWM or PWM close valve.

Brake Point Digit

The brake point digit sets the percent away from the target rate at which the control valve starts to turn at a slower rate so that it does not overshoot the target rate. The values range from 0 to 9, where 0 is a 5% rate, 1 is a 10% rate and 90 is a 90% rate.

Dead Band Digit

The dead band digit is the allowable difference between the target rate and the actual application rate. The values range from 1 to 9, where 1 equals 1% difference and 9 equals 9% of the difference.

Valve Cal 2

Note: *If the dual loop control feature is enabled, the valve cal 2 value will be replaced by the Sgain (pressure system gain) value.*

When a fast close valve is selected, the valve cal 2 value is utilized to enable a high resolution rate control for lower application rates.

Enter a non-zero value for the time, in milliseconds, which the valve will be fully opened before switching into high resolution control. For example, a value of 200 will give the valve a 200 millisecond “burst” at a full 12V to open the fast valve from the closed position before resuming product rate control. A zero value will disable this feature.

Flow Cal (Dual Loop Control Mode)

The flow cal value has two components which may be used to adjust the response of the application system.



Note: *It is recommended to set the Sgain value prior to making any adjustments to the flow cal value.*

Flow System Gain. The first digit(s) of the flow cal correspond to a flow system gain between 1 and 99. The higher the flow system gain, the more aggressive the system will respond to changes in flow rate.

Note: *When entering a flow gain value from 1 to 9, it is not necessary to enter a zero in front of the value.*

If the system adjusts to rate control changes too slowly, increase the flow gain digit(s) to increase the system response rate. If the system overshoots or oscillates around the desired flow rate, decrease the flow gain digit(s) to help stabilize the system.

Dead Band Digit. The last, or right most, digit in the flow cal value is the dead band digit. The dead band digit is the allowable difference between the target rate and the actual application rate. The values range from 1 to 9, where 1 equals 1% difference and 9 equals 9% of the difference.

Sgain (Pressure System Gain - Dual Loop Control Mode)

The default setting for the Sgain value is 100. To adjust the system aggressiveness, enter a value between 1 and 999 as necessary.

Note: *It is recommended to increase or decrease the current value in increments of 10 or less when making adjustments to the Sgain setting. If the new value does not produce significant or notable changes in the system response, increments of 20 may be used.*

Increase the Sgain value if the observed product pressure increases too slowly or if the system takes a long time to reach a set standby pressure or rate input change. If the system is consistently over shooting a set standby pressure or oscillating around a target rate, decrease the Sgain value until the system stabilizes.

Rate Cal

The following information must be known in order to determine which spray nozzles to use with the sprayer.

- Nominal Application Pressure _____ PSI [kpa]
- Target Application Rate _____ GPA [lit/ha]
- Target Speed _____ MPH [km/h]
- Nozzle Spacing _____ inches [cm]

From this information, calculate the volume per minute per nozzle as follows:

$$NVPM = \frac{Rate \times Speed \times NS}{5,940[60,000]}$$

where NVPM = Nozzle Volume per Minute (Gallons/Acre or [lit/ha]), Rate = Target Application Rate, Speed = Target Speed of Application and NS = Nozzle Spacing.

For Example:

Application Pressure = 30 PSI, Target Application Rate = 20 GPA, Target Speed = 5.2 MPH and Nozzle Spacing = 20 inches

$$NVPM = \frac{20 \times 5.2 \times 20}{5,940} = 0.35$$

Using the calculated Nozzle Volume per Minute of 0.35 at an Application Pressure of 30, select a tip that is capable of these application specifications. Contact a local sprayer supply dealer for available nozzles or spray tips.

Verifying Flow Rate Limits

The target rate for a field application also must be within the specified range of the flow meter measuring flow rate for the control channel.

| Flow Meter Model | Flow Range |
|-------------------|----------------------------------|
| RFM 5 | 0.1 - 5 GPM [0.2 - 18.9 L/min] |
| RFM 15 | 0.3 - 15 GPM [1.1 - 56.8 L/min] |
| RFM 60P | 1 - 60 GPM [3.8 - 210 L/min] |
| RFM 100 | 5 - 100 GPM [11.4 - 380 L/min] |
| RFM 200/ 200 Poly | 15 - 200 GPM [56.8 - 760 L/min] |
| RFM 400 | 25 - 400 GPM [94.6 - 1515 L/min] |

Tiered Boom Settings

A tiered boom configuration has two or more booms stacked one directly in front of the other and may or may not have different sets of nozzles capable of applying different rates.

Note: *Specialized plumbing, cabling and a relay box or product controller node are required to utilize a tiered boom configuration. Generally, sprayers are not setup for this feature from the factory.*

The boom tiers are connected to shut-off valves, which are controlled by a CANbus product control node. This configuration allows the machine to control a much wider range of application rates than a standard, single boom configuration.

For example, a low application rate may be applied by turning on the first tier sections only. Higher application rates may be applied by switching to the second tier booms with larger nozzles. A third and an even higher rate can be achieved by using both boom tiers in tandem.

Note: *The spray tips used on a tiered boom system must be extended range tips. In addition, the volume per minute of the second tier tips should not exceed 1.5 times the volume of the first tier's tips. The tier switching points should be set to 80% of the full flow volume for the boom tier tips.*

To access the Tiered Boom Settings screen:

1. Touch the Tools Menu icon from the Home screen.
2. Select the Product Control icon from the System submenu.
3. Touch the Calibration Settings button and select the Tiered Boom Settings button on the screen.

Note: *The tiered boom feature is not available in a granular control mode. Be sure that the configuration screen is set to a control channel set to control a liquid product application.*

The following settings may be configured on the Tiered Boom Settings screen:

Tier 1 Max. Set the desired maximum rate applied through the first tier boom sections.

Tier 2 Max. Set the desired maximum rate applied through the second tier boom sections.

Percent Tier Disable. The Percent Tier Disable is used to determine the percentage of the maximum tier rate at which tiers are disabled as the required volume per minute decreases. Using a Percent Tier Disable value allows the control valves to adjust to the target rate more quickly as the required rate decreases.

For Example:

A machine has a tiered boom configuration with the following capacities:

- Tier 1 Capacity up to 25 GPM [94.6 L/min]
- Tier 2 Capacity up to 38 GPM [143.8 L/min]

Using the given capacities, the following values should be entered as the Tiered Boom Settings:

- Tier 1 Max. = 25 GPM [94.6 L/min] x 0.8 = 20 GPM [94.6 L/min]
- Tier 2 Max. = 38 GPM [143.8 L/min] x 0.8 = 30 GPM [143.8 L/min]

Appendix A

Thus, as the volume per minute increases, the following tier switching should occur:

- 10 GPM [37.8 L/min] increasing to 20 GPM [75.7 L/min] = only tier 1 enabled
- 20 GPM [75.7 L/min] increasing to 30 GPM [113.6 L/min] = only tier 2 enabled
- 30 GPM [113.6 L/min] increasing to maximum flow rate = tier 1 and tier 2 enabled

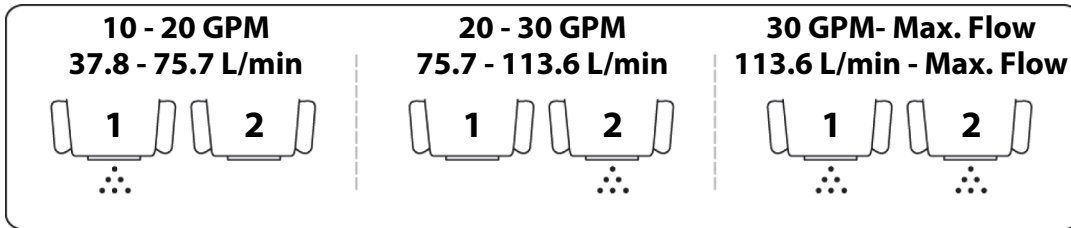

Note: *Percent Tier Disable only affects tier switching when the required volume per minute is decreasing.*

As rates begin to decrease from maximum, the Percent Tier Disable value is figured in. Thus, using the Tier 2 Max of 30 GPM [113.6 L/min] previously calculated and with the Percent Tier Disable set to 10%, tier 1 and 2 will switch to only tier 2 when the target rate decreases to 27 GPM [102.2 L/min].

So, for rates in gallons per minute:

$$30 \text{ GPM} - (10\% \text{ of } 30 \text{ GPM}) = 30 \text{ GPM} - 3 \text{ GPM} = 27 \text{ GPM}$$

or, for rates in liters per minute:

$$113.6 \text{ L/min} - (10\% \text{ of } 113.6 \text{ L/min}) = 113.6 \text{ L/min} - 11.3 \text{ L/min} = 102.3 \text{ L/min}$$

In operation, as the volume per minute decreases, the following boom tier switching should occur.

- Maximum flow rate decreasing to 27 GPM [102.2 L/min] = tier 1 and tier 2 enabled
- 27 GPM [102.2 L/min] decreasing to 18 GPM [68.1 L/min] = only tier 2 enabled
- 18 GPM [68.1 L/min] decreasing to 10 GPM [37.8 L/min] = only tier 1 enabled

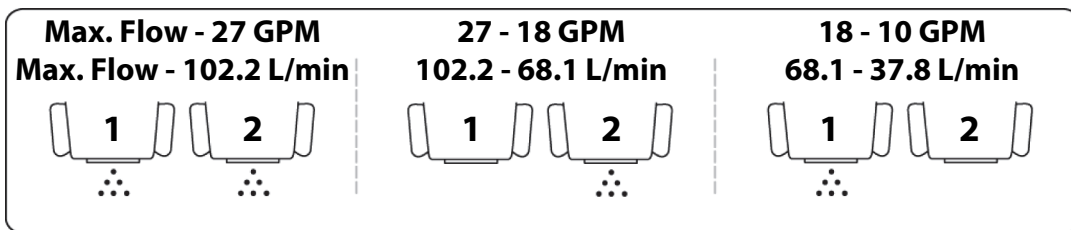

Granular Applications

Boom Cal

To calibrate section widths in inches [cm] for the granular application types:

- For single section control systems, enter the total spread width as the boom 1 cal.
- For dual section control systems, enter the left side spread pattern as boom 1 cal and the right side spread pattern as boom 2 cal.

Spreader Constant

Note: *The spreader constant should be verified by performing the procedure in Verification of Spreader Constant section on page 200.*

For Gran 2 or Gran 3 applications, gate width is the total of both openings.

Standard Rate display

For Rates displayed in 1 pound increments, the formula to calculate the spreader constant is:

$$SC = \frac{311,040}{L \times GH \times GW}$$

Where SC = the Spreader Constant, L = Length of belt travel in inches per 1 revolution of the encoder, GH = Gate Height in inches, GW = Gate Width in inches.

For Example:

Given a Length of belt travel of 13 inches, a Gate Height of 7 inches and a Gate Width of 15 inches:

$$\frac{311,040}{13 \times 7 \times 15} = 228$$

Enter 228 as the Spreader Constant if the field computer is set to display English units.

Metric Rate Display

For Rates displayed in 1 kg increments, the formula to calculate the spreader constant is:

$$SC = \frac{18,000,000}{L \times GH \times GW}$$

Where SC = the Spreader Constant, L = Length of belt travel in centimeters per 1 revolution of the encoder, GH = Gate Height in centimeters and GW = Gate Width in centimeters.

For Example:

Given a Length of belt travel of 33 cm, a Gate Height of 18 cm and a Gate Width of 38 cm:

$$\frac{18,000,000}{33 \times 18 \times 38} = 797$$

Enter 797 as the Spreader Constant if the field computer is set to display Metric units.

Verification of Spreader Constant

To verify and refine the spreader constant, perform the following procedure:

1. Weigh loaded truck and record the initial weight.
2. Enter the product density in lbs/cu. ft. [grams/liter] under the Density button in the Calibration Settings screen.
3. Set the total volume to zero for the product node being tested.
4. With the product node in the Manual mode, unload a portion of the load by toggling the boom switch on.
5. Determine the actual weight unloaded by re-weighing the truck.
6. Compare this weight to the total volume displayed on the field computer display. Perform the following calculation to refine the spreader constant, if desired:

$$\frac{OSC \times TV}{AW} = CSC$$

Where OSC = the Old Spreader Constant, TV = the Total Volume and AW = the Actual Weight unloaded and CSC = the Corrected Spreader Constant.

For Example:

Using an Old Spreader Constant = 228 [797], Total Volume = 2000 lbs [4400 kg] and an Actual Weight Unloaded = 1950 lbs [4290 kg]:

English:

$$\frac{228 \times 2000}{1950} = 234$$

The new Spreader Constant is 234.

Metric:

$$\frac{797 \times 4400}{4290} = 817$$

Repeat this procedure until the weight of the metered materials equals the total volume value.

Product Density

The density of the current product being applied must be entered in lbs/cu. ft. [grams/liter] when controlling a granular application.

Note: *To increase the system accuracy when applying at low rates, use the decimal shift feature as explained in the Decimal Shift section on page 115.*

Rate Cal

The target application rate must be entered in lbs/acre [kg/ha] as the rate cal value. Consult the equipment manual to ensure that the selected gate opening is capable of applying at this application rate.

Note: *The spreader constant must be recalculated anytime the gate opening is changed.*

Spinner RPM

For spinner box machines, use a product control node capable of controlling spinner speed.

Valve Type

Select the valve type currently used on the machine in which the field computer is installed.

Application

Select 'Spinner' as the application type. If spinner does not show up on the application rate, check that a CAN control node capable of controlling spinner applications is connected to the CANbus. Check the CAN control node and install a node that is capable of spinner control.

Meter Cal

The machine should be configured with a magnetic pickup coil mounted near the bolt heads on the spinner. Calculate the meter cal by multiplying the number of pulses (bolt heads) per revolution by 10.

$$\text{MeterCal} = N \times 10$$

For Example:

If the number of pulses per revolution is 4:

$$4 \times 10 = 40$$

then the value for the meter cal would be 40.

Spreader Constant

The spreader constant should be set to 0.

Rate Cal

The rate cal should be set to the desired RPM of the spinner.

Additional Calibration Data

Although not required operation, the following values may be programmed to enhance feedback for the operator during field application.

Entering Tank Volume or Bin Level

The tank volume or bin level displayed on the field computer is the calculated estimate of the amount of product remaining in the tank or bin (not the capacity of the tank or bin). The volume or level must be reset when refilling product to allow the field computer to calculate the remaining volume during product application. To reset the tank volume or bin level:

1. Touch the Tank Volume or Bin Level button to display the tank or bin configuration prompt.
2. Touch the Tank or Bin Size button to access the Total Tank Size prompt.
3. Use the on-screen keypad to enter the volume or level of product normally used to fill the tank or bin.
4. Touch the Accept icon to save the entered volume. The entered value will be displayed in the Reset Tank or Reset Bin button.
5. When refilling the tank or bin, touch the reset button to reset the tank or bin level quickly.

Low Tank Alarm

The field computer may be set to display or sound or an alarm when the calculated volume of product remaining in the in the tank falls to a user defined level. To setup the Low Tank Alarm, refer to the *Alarm Settings* section on page 116.

Reset Volume/Area Display Information

The current total area, total volume, field area and field volume information is displayed as applied information that can be reset at any time. Refer to the *Volume and Area Settings* section on page 113 to reset these display values.

Reset Display Distance

The current display distance, or odometer, registered by the field computer may be reset at any time. Refer to the *Speed* section on page 101 for more information.

APPENDIX

Testing Cables

B

Speed Sensor Extension Cable

Disconnect the extension cable from the speed sensor assembly cable. Hold the extension cable connector so that the keyway is pointing in the 12 o'clock position as shown below.

FIGURE 1. Speed Sensor Extension Cable Pin Diagram

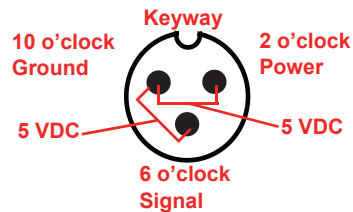

Note: If a radar type speed sensor is used, the voltage between the 10 o'clock and 2 o'clock positions may read 12V DC.

If a +5V DC voltage reading is not present, disconnect the flow meter cable and re-test the speed sensor cable. If the voltage reads +5V DC when the flow meter cable is disconnected, test the flow meter cable per Testing the Flow Meter/Encoder Cable section on page 204.

Testing the Speed Sensor Extension Cable

1. Enter a speed cal of 9999 by touching the Speed button on the Product Control screen.
2. Zero the odometer by entering a zero value in the Distance button.
3. With a small jumper wire (or paper clip), short between the 10 o'clock and 6 o'clock sockets with a 'short-no-short' motion. Each time contact is made, the distance total should increase by increments of 1 or more.
4. If the distance total does not increase, remove the section of cable and repeat the test at the connector that is the next closest to the node. If the distance total now increases with the short-no-short test, replace the defective cable as required.
5. If no pulses are registered, perform the above voltage checks.
6. If all of the cables test 'good,' replace the speed sensor.

Note: After testing is complete, re-enter the correct speed cal before starting an application.

Flow Meter/Encoder Extension Cable

Before starting this test, disconnect the flow meter cable from the flow meter. Hold the flow meter cable so that the keyway is pointing in the 12 o'clock position as shown below.

FIGURE 2. Flow Meter Extension Cable Pin Diagram

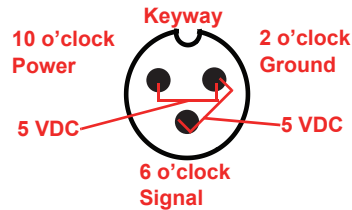

Testing the Flow Meter/Encoder Cable

1. Enter a meter cal of 1 in liquid or direct injection modes, or density of 1 and spreader constant of 0 in granular mode, on the Calibration Settings screen in the Product Control menu.
2. Touch the Volume/Area Settings button and note the total volume for each product node connected to the CANbus.
3. Turn the boom and master switch On.
4. With a small jumper wire (or paper clip), short between the 2 o'clock and 6 o'clock sockets with a 'short-no-short' motion. Each time contact is made, the total volume number should increase by increments of 1 or more.
5. If the total volume value does not increase, remove the section of cable and repeat the test at the connector that is the next closest to the node. Replace the defective cable as required.
6. Verify the pin connection and voltage from the previous chart.
7. If all of the cables test 'good,' replace the rate sensor.

Note: After testing is complete, re-enter the correct cal values before starting an application.

APPENDIX

C

Wireless Communications & Remote Service

The Envizio Pro, with a Slingshot® Field Hub, allows the operator to wirelessly transfer application data back to the home or office and transfer prescription data from the office to the field. This feature also adds the ability to allow service technicians and support specialists to remotely control the field computer. With a Slingshot Field Hub, help is just a touch away.

Via the Field Hub, the field computer can also be used to keep up-to-date with the latest weather forecasts or crop prices from Internet web sites while still managing product application.

Note: For instructions on installing and setting up the Slingshot Field Hub, refer to the Field Hub Installation Guide provided with the wireless device.



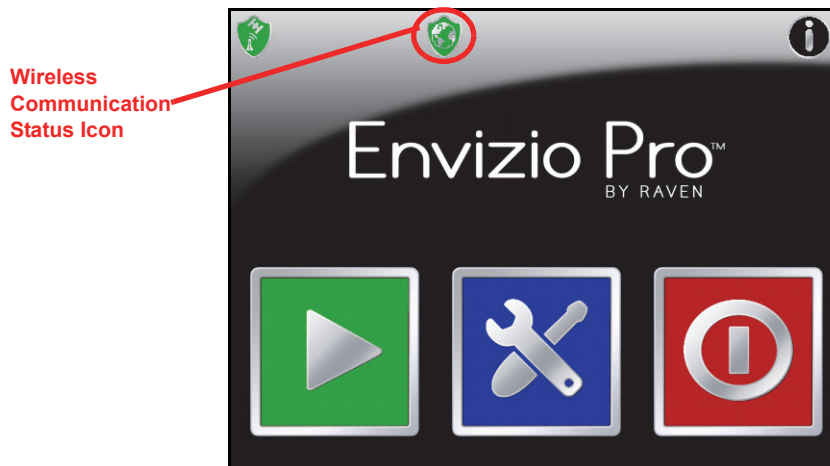

Wireless Communication Status

The status of wireless communications is displayed along the top of the Home screen.





Appendix C

The following icons may be displayed in the wireless status area:

| | |
|---|---|
|  | No Device Connected - No supported wireless device is connected to the ethernet port on the field computer. This icon is also displayed if wireless communication is unavailable or has been lost. |
|  | Communication OK - The status of wireless communication is good and no errors or alarms are present. |
|  | Communication Error - An error has occurred with wireless communication or during a file transfer. |
|  | Communication Lost or Unavailable - This icon will be displayed if the registration process has not been successfully completed. |

The wireless status symbols also display the file transfer status for any files to or from the field computer.

| | |
|---|--|
|  | Sync In Progress - The arrow symbol is displayed on the wireless status icon while the field computer and the Slingshot® site are synchronizing. |
|  | Files Received - The envelope symbol is displayed on the wireless status icon when files have been received by the field computer. When this symbol is displayed, touch the icon to display the File Manager tab. |

Wireless Status Screen

Touch the wireless status symbol displayed on the Home screen to display the Wireless Status screen.

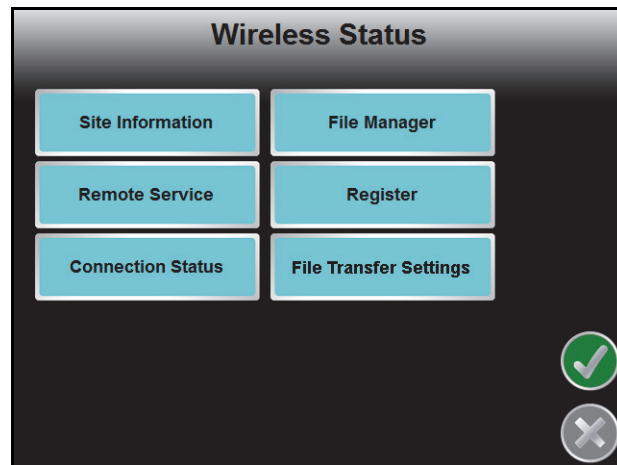

Site Information

Touch the Site information button to view information from the Slingshot® site.

Remote Service

The Remote Service feature allows a service technician to view and control a field computer in the field from his or her service location and assist the machine operator diagnose or troubleshoot the system.

Note: *The service technician will be able to determine whether a remote service session is necessary to assist with any issues encountered with the field computer. Contact a local Raven dealer or technical service provider before starting the remote service feature.*

To begin a remote service session:

1. Touch the Wireless Status icon on the Home screen and touch the Remote Service button.
2. Touch the “Enable Remote Service” button. Have the code displayed on the screen available when contacting a local Raven dealer for support.
3. Read the code to the technician to allow them to view and control the field computer and product control system.

Note: *If an error code is displayed in place of the remote service code, wait a few seconds for the Field Hub to receive correct data and the error should be cleared automatically. Do not initiate remote service while an error code is displayed. If the error message does not clear after several seconds, contact a local Slingshot or Raven dealer for support.*

Connection Status

The connection status screen displays the following information:

- **Signal Strength** - Displays bars to represent the current strength of wireless signal. Four bars represent a strong signal.
- **Ethernet Status** - Displays the status of the connection via the ethernet port on the back of the field computer.
- **Internet Status** - View the status of communication with the world wide web in this area.
- **Suggested Solutions** - If any issues or errors are detected, possible solutions will be displayed in the solutions area.

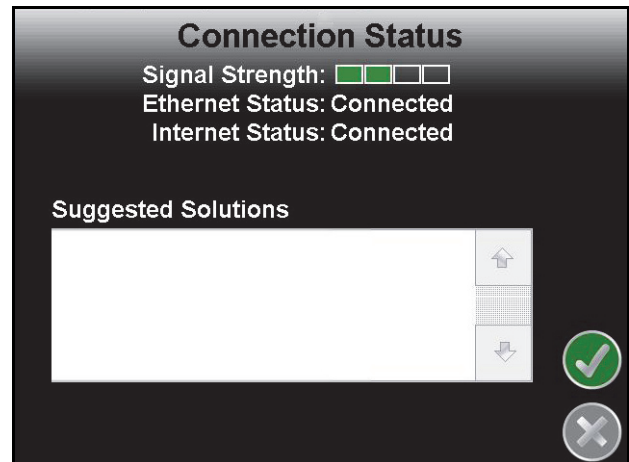

Note: *If any error conditions are encountered, the Communication Status screen will display possible solutions.*

File Manager

Access the Wireless File Manager to view a history of files recently transferred to or from the field computer.

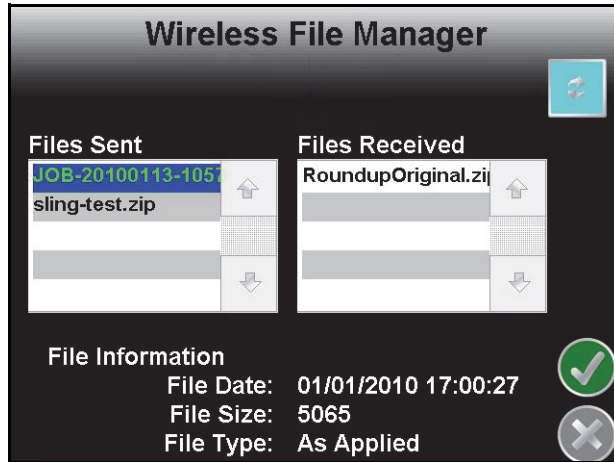

Use the up or down arrows to scroll through the history of files sent from, or received by, the field computer.

Touch a file from one of the lists to view file information such as the file type and size as well as the date and time the file was sent or received.

Note: Completed job data may be exported to a connected USB flash drive if desired or if a wireless connection is unavailable. Refer to the Performing File Maintenance section on page 155 to export a Slingshot® data package using the File Maintenance feature. Jobs exported to a USB flash drive may then be uploaded to the Slingshot web site using a home or office computer.

Registration

The Registration tab is used to register the Field Hub with the Slingshot® web site and activate the various features of wireless communication on the field computer.

Note: If the Field Hub has been registered previously, the Registration button will display as re-registration. Touching the “Re-Register” button will display the Re-Registration Warning prompt below. To re-register the Field Hub, touch the green check mark and proceed with the registration instructions to re-register the Field Hub.



To register:

1. Touch the Wireless Status icon on the Home screen and select the Registration button.

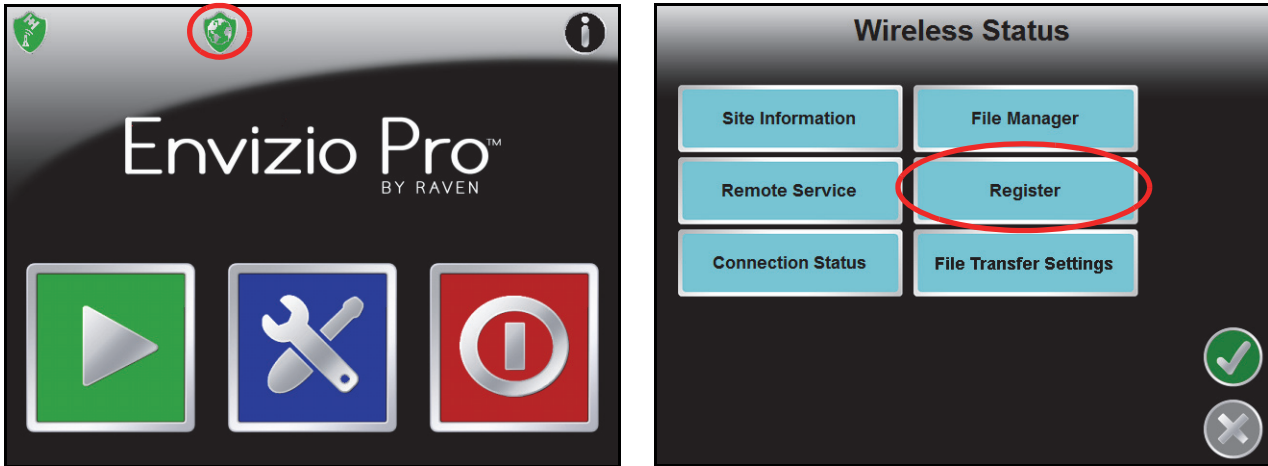

2. Wait while the field computer registers with the Slingshot® web site and receives the registration code. It may take up to 15 minutes after the registration code is received for features to become fully enabled.

Note: *Be sure to enable the Remote Service and Web Access features if desired (recommended). These features may be enabled later by accessing the Slingshot® site.*

To test wireless access:

1. Wait for the field computer to automatically search for available files for transfer. This process may take up to five minutes.
2. If the Remote Service feature was enabled during registration, select the Remote Service tab and touch the “Enable Remote Service” button.
3. If a remote service session is enabled successfully, touch the button now labeled “Disable Remote Service.”
4. Exit the Wireless Status screen by pressing the “OK” button in the lower, right corner of the screen.
5. If the Web Access feature was enabled during registration, touch the Tools Menu icon and select the Web icon within the Computer sub-menu to open the field computer Internet browser and test the web access feature.

File Transfer Settings

The File Transfer Settings options allow the operator to configure automatic file upload features with the Slingshot Field Hub. Touch the File Transfer Settings button and select one of the following options:

Automatically Upload. With the automatic upload option selected, the field computer will automatically upload the completed job file to the Slingshot server when the operator stops the job operation. If the job is resumed at a later date, a separate copy of the job will be available on the Slingshot server for review.

Prompt. With this option selected, the field computer will prompt the operator to upload job files each time a job is closed. When the operator stops a job operation, the field computer will provide a prompt and allow the operator to upload the latest job file or to wait. This option may be preferable if jobs are frequently stopped and resumed to minimize data usage and ensure that only the completed job file is uploaded to the Slingshot server.

Disable. Select this option to disable all automated wireless file transfer options. To upload files to the Slingshot server, the operator must manually initiate wireless file transfer using the File Maintenance features or use a USB flash drive to transfer completed job information from the field computer to a home or office PC.

Refer to Chapter 8, *Software Updates and File Maintenance*, for additional assistance with the File Maintenance features of the Envizio Pro field computers.

D

Weather Station Overview

Envizio Pro field computers with software version 3.6 or newer are capable of reading information from an external weather station and recording this information into job report files. The information being recorded to the report includes:

- Temperature
- Relative Humidity
- Dew Point
- Barometric Pressure
- Wind Speed
- Wind Direction
- Wind Gust

The Envizio Pro may only read information from one specific model of weather station. This unit is the WatchDog Sprayer Station Model 3349SS (P/N 117-0171-138) manufactured by Spectrum Technologies, Inc. This system may be ordered through any Raven dealer. For more information on this system contact Spectrum Technologies at (800) 248-8873.

Connecting the Weather Station

The weather station may connect to the field computer via either of the following connectors:

- “COM2” or “Console” connector on the main interface or chassis cabling.
- “COM3” or “Light Bar” connector on the auxiliary interface or chassis cabling.

Note: *If the field computer is connected to an external Raven serial controller, the weather station must be connected to ‘COM 3/Light bar’ on the auxiliary interface or chassis cabling.*

Weather Station Activation Key

In order to use the weather station with the Envizio Pro, the weather module authorization code (P/N 077-0180-030) must be purchased from a Raven dealer. Once the code has been purchased and registered on-line, the activation key must be entered into the Envizio Pro.

Note: *Refer to the Special Features Registration section on page 138 for additional assistance with obtaining the activation key and entering the authorization code.*

Weather Station Configuration

To view weather information collected by the weather station:

1. Touch the Tools Menu icon on the Home screen.
2. Select the Weather Station icon from the Computer menu to display the Weather Station screen.

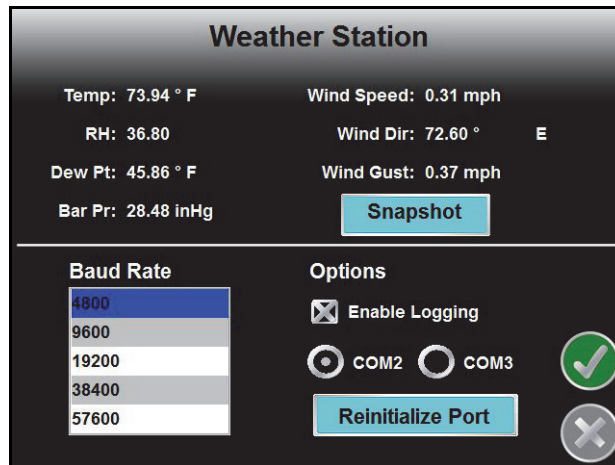

Note: *The upper portion of the Weather Station screen displays the current weather conditions collected by the weather station. The snapshot button will only display during an active job.*

3. The default baud rate for communication with the weather station is 4800 and should generally not need to be changed.
4. Ensure that the Enable Logging option is enabled to record weather information during an active job and provide this information on the completed application report file. If weather data is not needed, leave this option un-checked to help conserve memory on the field computer.

5. Select the communication port to which the weather station is connected. Select the:
 - COM2 option if the weather station is connected to the COM2 or Console port on the main interface or chassis cables.
 - COM3 option if the weather station is connected to the COM3 or Auxiliary port on the auxiliary interface or chassis cables.
6. Touch the Reinitialize Port to restart the weather station comm port if necessary. This feature may be used if the weather information does not display current conditions as anticipated.

Using the Weather Station

If weather station logging is enabled during an active job, the Envizio Pro will periodically record current weather conditions for the application report.

To view current conditions or other weather station information during an active job:

1. Touch the Menu icon in the lower, right corner to access the in-job menu.
2. Select the Weather Station icon to display the Weather Station screen.
3. Touch the snapshot button to manually record the current conditions to an active job for the application report.

Note: *The snapshot button will only display during an active job.*

4. Touch the Reinitialize Port to restart the weather station comm port if the current conditions reported by the station do not reflect conditions as expected.

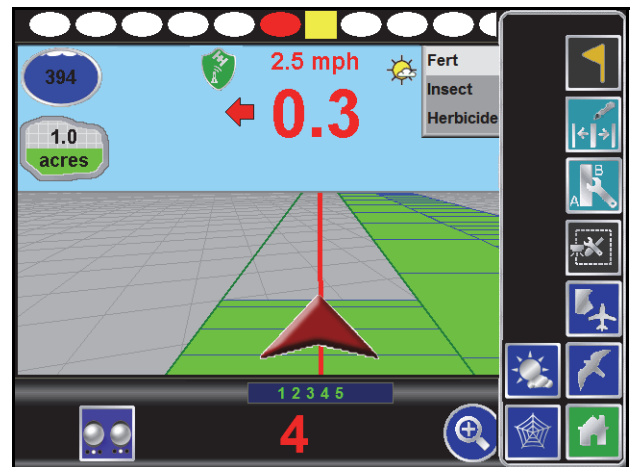

APPENDIX

E

Updating CAN Nodes via the Envizio Pro

Envizio Pro field computers with software version 2.2 or higher and CAN firmware version 10 or higher are capable of programming nodes on the CANbus directly through the field computer and connected cabling using a USB flash drive with the CAN Update program.

Note: Before trying to update a CAN node, make sure the node is communicating properly over the CANbus. If the node is not communicating properly, the field computer will be unable to update the node.



NOTICE

Updating a CAN node erases the current settings in the node. To retain settings and calibration data, be sure to write down all settings stored by the node(s) being updated.

CAN node updates will be made available periodically on the Raven Applied Technology web site:

www.ravenhelp.com

Note: The .hex update file must be located in a folder labeled “CANupload” on the root of the USB flash drive (e.g. “G:\canupload”) used with the field computer. If the update files are downloaded from the Raven web site, the required file structure will be created when the files are extracted.

To Update CAN Nodes

Important: Do not remove power or unplug any cabling connections during the node update process. It is recommended to start the machine and keep the engine running during the update process to maintain constant power over the CANbus system. If the update process fails to complete the update successfully, the node may become unresponsive. Unresponsive nodes will need to be returned to Raven for repairs.

1. Start the field computer and touch the Information icon in the upper, right corner of the Home screen.



- Touch the  icon on the About Envizio Pro screen to display the CAN Diagnostics screen.

Note: The current CAN Firmware version is displayed on the CAN Diagnostics screen.

- Insert the USB flash drive with the required .hex files into an available USB port on the field computer.
- On the CAN Diagnostics screen, select a node to update and then select the  to begin the CAN Update Program.

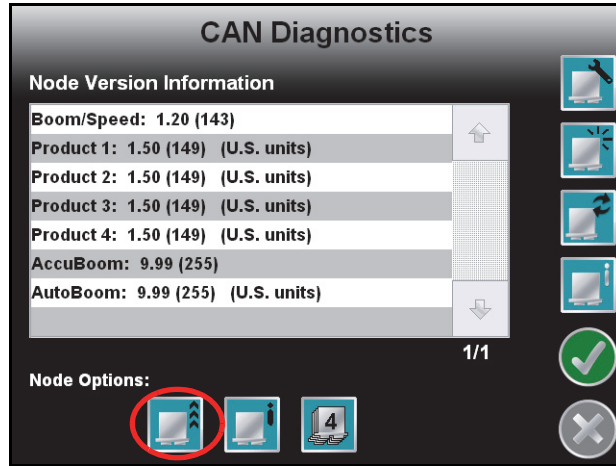

- The Updates screen displays a list of available node updates. This screen also displays the firmware version to which each node will be updated if the update is applied.

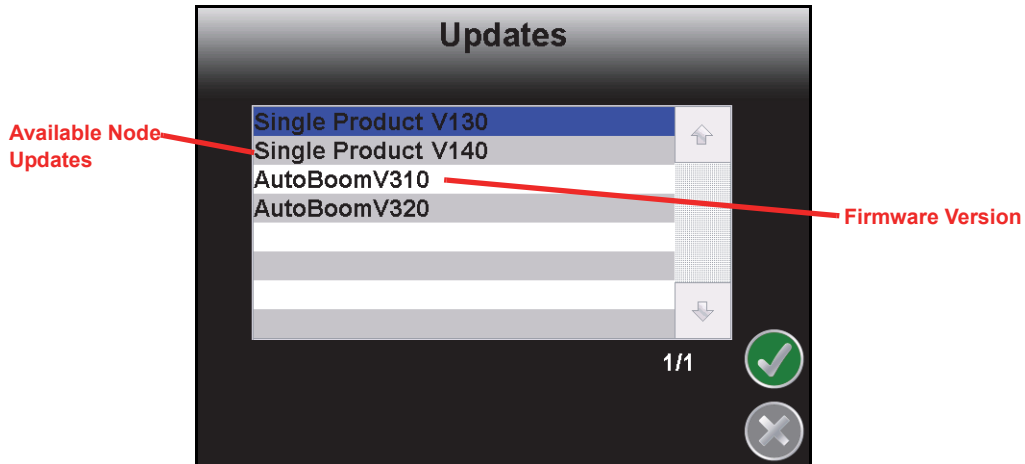

- Touch the **Accept**  icon to start the update.

Note: If the field computer cannot communicate with the selected node, the CAN Update Program will display an error. Troubleshoot the node and retry the update.

- The field computer begins communicating with the selected node to update. If communication is successful, the field computer will begin the update by erasing the node's memory.

Note: The field computer may take several minutes to prepare and apply the software update to the node. If errors are encountered during the process, re-apply the node update.

- To update other nodes via the CANbus repeat step 6 through 7.

APPENDIX

F

Updating the On-board DGPS Receiver

Occasionally, updates for some Envizio Pro II on-board DGPS receivers may be made available for download from the Applied Technology web site:

www.ravenhelp.com

Note: *The receiver update may be located under the additional software versions available on the Envizio Pro II field computer software updates web page.*

These updates are made available for field computers with the on-board receiver serial numbers starting with “BZZ” or “BFN” and are not required unless a specific issue encountered during operation has been addressed with the update. Please review the required components and read the firmware update procedure before starting the process. Contact a local Raven dealer for more information or additional assistance with any part of the firmware update.

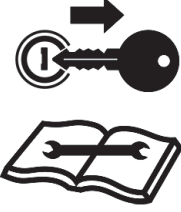
| | |
|---|---|
|  | CAUTION Updating GPS firmware may result in the loss of OmniSTAR correction services. Internal receivers with a serial number beginning with “BFN13” or lower are capable of OmniSTAR correction services with NovAtel firmware “OEM060220SN0009” or lower. Updating the GPS engine firmware will result in the loss of OmniSTAR subscription services. |
|---|---|

Required Components

- Envizio Pro field computer with an on-board receiver serial number starting with “BZZ” or “BFN.”
- Home or office PC or laptop with Microsoft Windows® operating system and the WinLoad utility.
- “Straight through” serial cable (optional)
- USB to Serial adapter (optional)
- Envizio Pro cable with ‘GPS Out’ connector
- WinLoad and firmware update .hex file

Receiver Information

Perform the following steps to access the information from the GPS receiver required for unlocking additional features of the on-board GPS receiver:

1. Touch the GPS Status icon in the upper, left corner of the Home screen.
2. Touch the Receiver Information icon along the right side of the GPS Health screen.
3. Copy the displayed receiver information and provide this information to a local Raven dealer when acquiring the unlock code for additional GPS services or features.

GS Satellite Subscription

Note: For best service, verify that the Envizio Pro software is 3.7.1 or newer and the GPS firmware version is 6.04 or newer before purchasing a GS Satellite subscription. Ensure the GS activation code is entered before attempting to purchase the GS Satellite subscription. Refer to the Special Features Registration section on page 138 for assistance with entering an activation code.

1. Touch the Tools Menu icon on the Home screen and select the GPS menu.
2. Touch the Differential icon and select GS Satellite to display the GS Satellite information.
3. Copy the PAC Code displayed.
4. Visit the Slingshot Store at the web address below and purchase the desired GS Satellite subscription.

<https://ravenslingshot.com/store/>

Updating the On-Board DGPS Receiver

1. Power up the Envizio Pro II field computer.
2. Check the cable connections on the back of the field computer and trace the cable connected to the auxiliary interface connector.

FIGURE 1. Envizio Pro II Rear Panel Features and Connectors

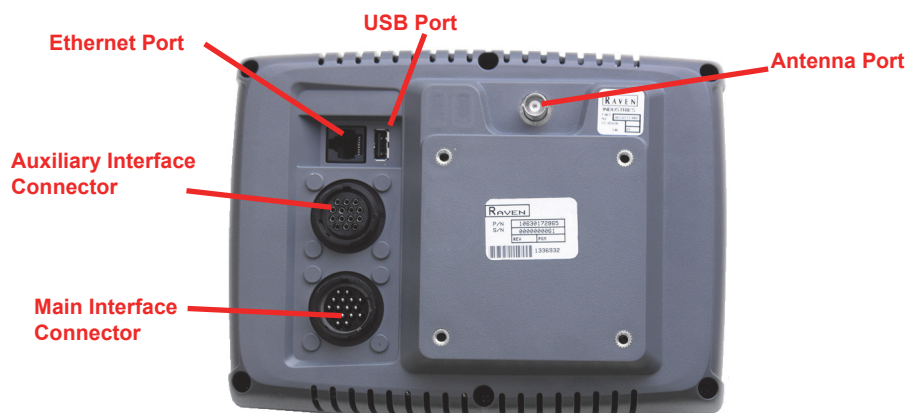

Note: If there is no cable connected to the auxiliary interface connector, contact a local Raven dealer for more information and assistance.

3. Locate the connector labeled “GPS Out” on the cable connected to the auxiliary interface connector.

4. Disconnect any serial cables currently connected to the GPS out port and route the port to a serial port on a home or office PC or laptop.

Note: *If the PC or laptop does not have a serial port, a USB to serial port adapter will be required to proceed with the firmware update procedure.*

If the GPS out port will not reach the PC or laptop serial port directly, use a straight through serial cable to extend the port connector.

5. From the Envizio Pro II home screen, touch the Tools Menu (blue) button and select the Source icon from the GPS menu.
6. On the GPS Source screen, write down the current source setting before selecting the Internal GPS Receiver option.
7. Touch the Accept icon to return to the main Tools Menu display.
8. Select the Output icon from the GPS menu.
9. On the GPS Output screen, write down the current NMEA message rates before setting all NMEA messages to zero.
10. Touch the Accept icon to return to the main Tools Menu display and then touch the Home icon to display the field computer Home screen.
11. Touch the Shutdown (red) button on the Home screen. Do not press and hold the power button to shutdown the field computer at this time.
12. On the PC or laptop, open the downloaded firmware update folder and locate the WinLoad application.
13. Click on the Settings option in the upper, left corner of the WinLoad window and select the COM Settings... option.

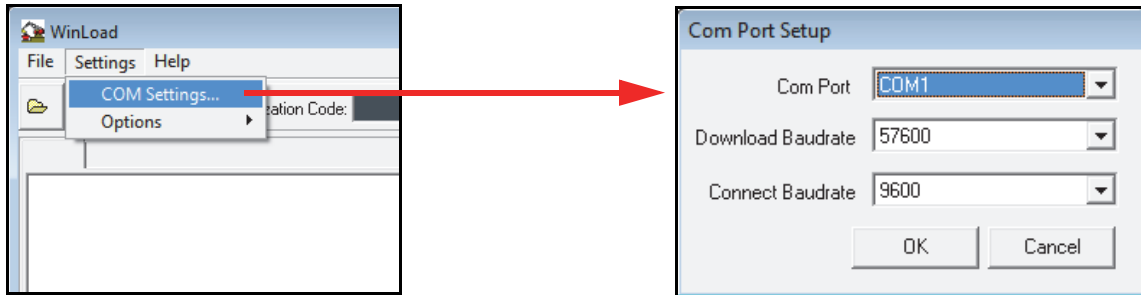

14. In the Com Port Setup prompt, select the com port on the PC or laptop connected to the GPS out connector. Refer to the operating system help for assistance determining which com port is connected to the field computer cable.
15. Set the Download Baudrate to 57600.
16. Set the Connect Baudrate to 9600 and click OK.
17. Click on the File option in the upper, left corner of the WinLoad window and select the File Open... option. Use the file browser to locate and select the update .hex file (e.g. "3902. hex").
18. The file information should now be displayed in the main WinLoad panel.
19. Click the Write Flash button to the right side of the main WinLoad panel. Immediately start the next step when the timer displays.
20. Press and hold the Envizio Pro II power button until the unit shuts down. Press the power button to turn the field computer back on.

Appendix F

21. The WinLoad program should display information in the main panel to indicate that the update is in progress.
22. Wait for the WinLoad update to complete.
23. Once the update has finished, close the WinLoad application and restart the field computer.
24. Verify that the firmware update was applied successfully:
 - a. Touch the Tools Menu (blue) button from the field computer Home screen
 - b. Select the Health icon from the GPS menu. Check that the version displayed on the GPS Health screen is the new firmware version.
25. Touch the Accept icon to return to the main Tools Menu display.
26. Reset the NMEA and Source settings as appropriate before beginning any field operations.

APPENDIX

G

Tank Fill Monitor Calibration

Overview

An optional tank fill monitoring system is available to monitor the volume of product transferred from the nurse truck to refill the product tank.

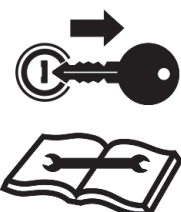

⚠ CAUTION

The tank fill monitoring system does not control or automatically shut off the tank refilling equipment. Do not leave the machine or refilling system unattended while operating.

Tank Fill Calibration

To access the pressure cal, fan cal and metered weight settings from the Home screen:

1. Touch the Tools Menu icon and select the Product Control icon from the System menu.

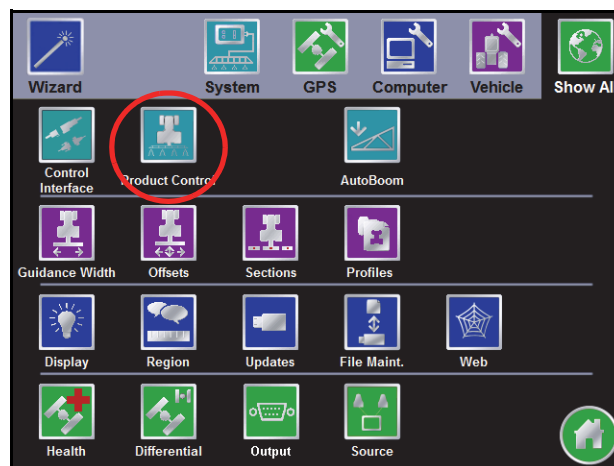

2. Touch the Volume/Area Settings button.

Appendix G

3. Touch the Tank Fill button and then touch the Configuration button to display the Tank Fill Config screen.
4. Touch the Tank Capacity button and enter the maximum volume for a full tank. It is recommended to enter the maximum desired capacity, not the actual tank capacity to help avoid overfilling the tank.
5. Touch the High Alarm % and enter the percentage of the entered tank capacity at which the system will provide an alert for the operator.
6. If there is currently product in the tank, touch the Current Tank Volume button and use the on-screen keypad to enter the volume in the tank.
7. Touch the Low Alarm button and enter the low tank volume at which the system will provide an alert for the operator.
8. Select the Fill Meter Cal. button and enter the calibration value for the flow meter used to measure the volume of product transferred to fill the tank.

| Parameter | Value |
|---------------------|---------|
| Tank Capacity | 1000.00 |
| Current Tank Volume | 250.00 |
| High Alarm % | 0 |
| Low Alarm | 50.00 |
| Fill Meter Cal. | 250 |

Tank Fill Operation

During an active field operation, the tank fill system allows the operator to access the fill system, measure and monitor the actual volume of product transferred to the tank, and automatically update the tank volume available for application.

To use the tank fill system during a field operation:

Note: *If the system has not been calibrated already, touch the Configure button and refer to the Tank Fill Calibration section on page 221 to set up the fill system.*

1. Use the product rate display area in the upper, right corner of the guidance display to select the desired product to be monitored during the tank fill process.

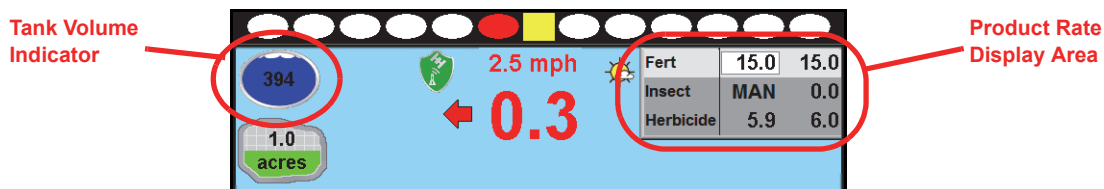

2. Touch the tank volume indicator displayed in the upper, left corner of the guidance display. The Tank Fill screen will be displayed.
3. Touch the Start Fill button to begin monitoring the fill process. The tank fill monitoring system will display information such as the current tank volume and the configured tank fill capacity.
4. Begin refilling the product tank.
5. When the field computer provides an alert, stop the nurse tank system to stop filling the product tank.
6. On the Envizio Pro, touch the Stop Fill button to stop monitoring the product fill system. The Envizio Pro will adjust the Tank Volume Indicator for the selected product when the operator returns to the guidance screen.

APPENDIX

H

Blockage Monitoring Sensors

System Overview

With the optional blockage sensor system, the field computer is capable of monitoring seed or product flow during field operations. If an obstruction is detected, the field computer will display information from the sensors to help the operator quickly locate the obstruction.

During a field operation, the status of the blockage sensor system is displayed at the bottom of the Guidance screen.

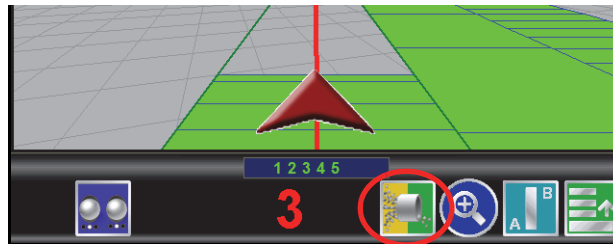

The field computer may be connected to two separate sensor loops with up to 120 sensors per loop to monitor seed or product flow at various locations on the implement depending upon the level of system monitoring desired.

Blockage Node Detection

If the blockage system is installed and correctly connected to the field computer, the blockage node should display on the CAN Diagnostics screen. Refer to the *CAN Diagnostics* section on page 30 for details on using CAN Diagnostics.

If the blockage node is not displayed on this screen, check the node connections and restart CANbus communication. If the node is still not detected, contact a local dealer for assistance.

Configuring Blockage Sensor Loops

Each sensor loop may be configured individually to allow the system to accurately monitor the status of separate delivery systems (e.g. seed or product tubes) and alert the operator to obstructions in either delivery system. To properly monitor the seed or product delivery system, the field computer must be configured for the number of blockage sensors installed in each section of the implement.

1. Review the *Offsets and Implement Type Selection* section on page 142 to configure the implement.
2. After the implement is correctly configured, select the Blockage  icon from the System menu. The Blockage Monitor Setup screen will be displayed on the field computer.

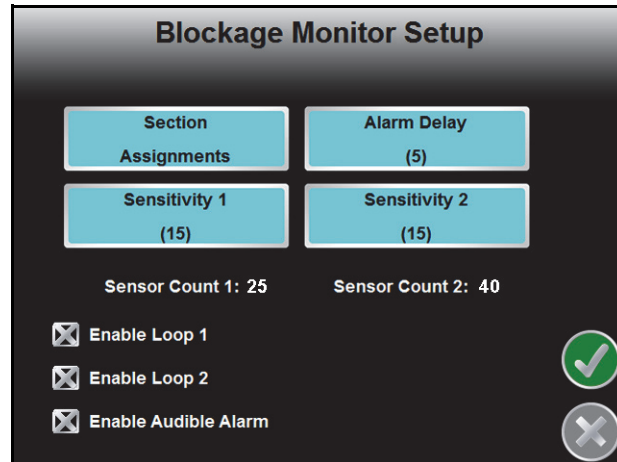

The following information is displayed at the bottom of the Blockage Monitor Setup screen:

- Currently configured sensor counts for each configured sensor loop. The field computer must be programmed for the number of sensors in each loop. This value does not change when sensors are added or removed from the blockage monitoring system.
- Enable options for sensor loop 1 and 2.
- Enable option for the audible alarm feature for the blockage monitor.

Section Assignments. The Section Assignments button allows the operator to configure the sensor loops connected to the control for each implement section. Refer to the *Configure Sensor Loops* section on page 225 information on the sensor section setup procedure.

Alarm Delay. The alarm delay setting allows the operator to set a delay between when the system detects a blockage and when the alarm features are activated on the field computer. Use this setting to avoid displaying errors during field operations if the control system intermittently encounters momentary stoppages in product or seed flow.

Loop Sensitivity. Use the sensitivity value to set the approximate number of seeds per second which each sensor in the loop should detect when the system is operating normally. If a sensor does not detect the set value for seeding rates, the system will display a blockage or obstruction and indicate which sensor is detecting the error. The default sensitivity value is 15.

Refer to the *Setting the Sensitivity* section on page 227 for more information on setting and adjusting the sensitivity value for each sensor loop.

Configure Sensor Loops

To setup the blockage monitoring sensor loops:

1. Touch the Section Assignments button. The Sensor Section Setup screen for the first implement section will be displayed.

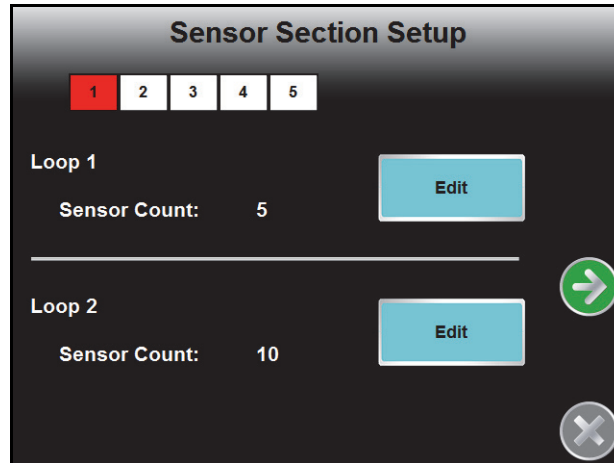

2. Touch the Edit button corresponding to loop 1 and loop 2 and use the on-screen keypad to configure the number of sensors associated with the first implement section. Touch the Next icon to advance to the next implement section.

Note: Only enter values for the number of configured sections on the drill. Leave the value at zero for any unused sections.

Do not count any sensor more than once. If a sensor is used for multiple sections, count the sensor for the section most frequently used and do not count the sensor for the remaining section(s).

3. After the sensor loops are configured for each implement section, touch the Next icon to display the Sensor Summary screen. Review the configured sensors per section in each loop and touch the Accept icon to store the displayed settings. To reconfigure any of the sections, touch the Previous icon to return to the section setup screens.

Blockage Monitor Status

During field operations, the field computer displays the status of each sensor loop at the bottom of the Guidance screen.



The left half of the icon displays the status of sensor loop 1 while the right half of the icon displays the status of sensor loop 2. The blockage status will display:

- Green when the system is operating normally.
- Yellow when a product blockage or dirty sensor is detected in the system. Check the indicated sensor locations in the *Blocked* display and clear any obstructions as necessary during operation.
- Red if a communication issue is detected with the blockage sensors. Check sensor assemblies and cables for disconnected or damaged parts and replace parts as necessary.

Touch the blockage status icon to access the Blockage Monitor Status screen.

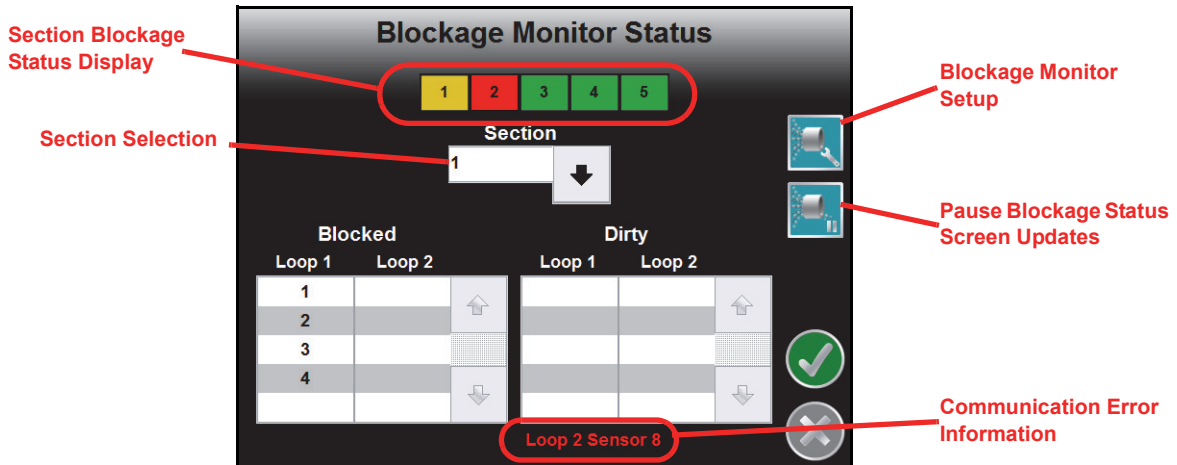

At the top of the status screen, the sensor status for each implement section is displayed to assist the machine operator locate and address equipment blockages. Touch the section selection drop down to display detailed information for each sensor loop for the selected section.

Blocked. When a blockage is detected in loop 1 or loop 2, the sensor number(s) which detect an obstruction or blockage will be displayed in this area. Check these sensor locations for obstructions in the line to clear the blockage condition.

Note: *To help locate blockages during operation more quickly, it is recommended to number the sensors. Refer to the seed blockage sensor installation instructions for details on numbering the sensors.*

Dirty. Sensors may need to be cleaned periodically during seeding operations to ensure that the system is accurately detecting the flow of seed or product through seed tubes. Check and clean the indicated sensor(s) to ensure optimal system performance.

When monitoring particularly dirty seed types or products, it may be necessary to clean each sensor in the loop when a the system indicates a sensor or sensors in the loop are dirty.

Communication Error Information. If a communication issue is encountered on either sensor loop, the status screen will display the value of the of the last sensor which the system is currently able to detect on the sensor loop. For example, “Loop 2 Sensor 8” means that sensor 8 on loop 2 is currently communicating correctly. This information may be useful to address communication problems.

Blockage Monitor Setup Icon. Touch the setup icon to go to the Blockage Monitor Setup screen if necessary during a field operation to adjust loop sensitivity or alarm settings. Refer to the *Configuring Blockage Sensor Loops* section on page 224 for details on using the Blockage Monitor Setup screen.

Pause Status Updates Icon. The blockage system updates the status screen continuously during field operations. Use the pause screen updates icon to ignore status screen updates and to allow the operator to address multiple blockage conditions or to review blockage information for momentary blockages detected during field operations.

Note: *The pause icon only pauses updates to the blockage monitor screen. Additional blockage alerts will still be received by the field computer and product control features will be unaffected.*

Setting the Sensitivity

Refer to the following table to set and adjust the sensitivity setting for each loop for a specific seeding operation.

| Sensitivity | Seeds per Second | | Sensitivity (cont.) | Seeds per Second (cont.) |
|-----------------|-------------------------|--|---------------------|--------------------------|
| 0 ^a | Loop off | | 70 | 148 |
| 1 ^b | 1 seed every 30 seconds | | 80 | 281 |
| 5 ^b | 1 seed every 20 seconds | | 90 | 539 |
| 10 ^b | 1 seed every 10 seconds | | 100 | 1043 |
| | | | 110 | 2019 |
| 15 | 1 | | 120 | 4400 |
| 20 | 7 | | 121 | 4800 |
| 30 | 17 | | 122 | 5300 |
| 40 | 27 | | 123 | 5800 |
| 50 | 44 | | 124 | 6400 |
| 60 | 80 | | 125 | 7000 |

a. A sensitivity setting of zero will disable the sensor loop and blockage alarms.

b. A sensitivity value less than 15 will allow the sensor loop to scan for periods longer than 1 second to count seeds down to one seed per 30 seconds.

The best obstruction and blockage detection is achieved when the sensitivity is set as high as possible without encountering a constant alert condition. To set the sensitivity for a specific field operation:

1. Ensure that the system is clear of obstructions.
2. Select and enter a sensitivity value from the table above and begin operation. Ensure that the system continues to display a normal operating condition at the initial setting.

Note: *If the seed blockage sensors consistently display a blockage alert, select a lower initial sensitivity value before proceeding.*

Appendix H

3. Increase the sensitivity until the system indicates a blockage.
4. Decrease the sensitivity by 3 to 5 units at a time until the field computer no longer indicates blockage conditions.

Note: *Do not decrease the sensitivity value below the initial value. Check the indicated sensor locations and clear any obstructions and repeat the above procedure if the sensitivity value is decreased below the initial setting.*

OmniSeed Calibration Overview

The field computer will display the following settings on the Calibration Settings screen when interfacing with an optional Raven OmniSeed system for automatic seed rate control:

- Pressure Calibration
- Fan Calibration
- Metered Weight

The above settings are used to calibrate the field computer for the seeder air cart.

Remote Tank Console

The OmniSeed system also features a remote tank console that may be used while performing catch tests during meter priming and calibration. Refer to the *Remote Calibration Console* section on page 238 for additional information on using the tank console with the Envizio Pro field computer.

Optional Ultrasonic Bin Level Sensors

The OmniSeed system is capable of utilizing optional ultrasonic bin level sensors to monitor the seed bin level during seeding operations. When ultrasonic sensors are connected, the field computer will display a percentage of product remaining in the air cart bin during seeding operations.

OmniSeed Calibration Procedures

To access the pressure cal, fan cal and metered weight settings from the Home screen:

1. Touch the Tools Menu icon and select the Product Control icon from the System menu.

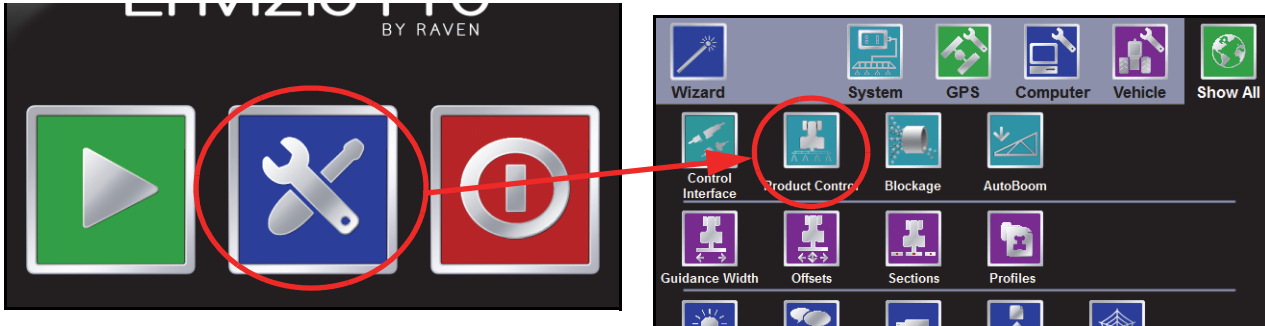

2. Next, touch the Calibration Settings button to display the Calibration Settings screen.

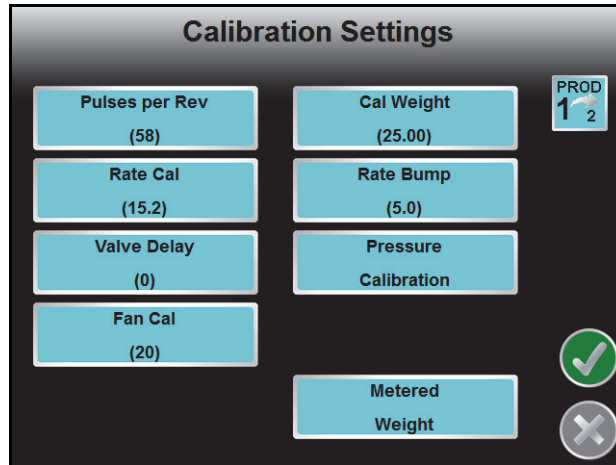

Optional Bin Pressure Sensor Calibration

Touch the Pressure Calibration button to access the Pressure Cal screen.

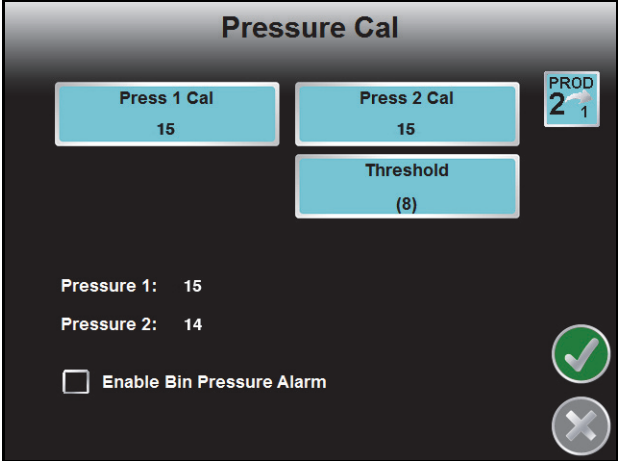

Pressure 1 and 2 Cal. The Pressure Cal screen displays the current calibration setting for each pressure transducer connected to the product. Touch the Pressure Cal button and use the on-screen keypad to enter a different target pressure for the bin.

Threshold. The threshold setting is the lowest acceptable pressure detected in the air seeder system before the field computer displays an alert.

Pressure 1 and 2 Display. The current pressures detected by the pressure transducers on each product are displayed in the bottom half of the Pressure Cal screen.

Enable Bin Pressure Alarm. Select the bin pressure alarm option to allow the field computer to sound an audible alarm if any of the bin pressures fall below the set threshold value.

Fan Calibration

Touch the “Fan Cal” button to access the Fan Calibration Settings screen.

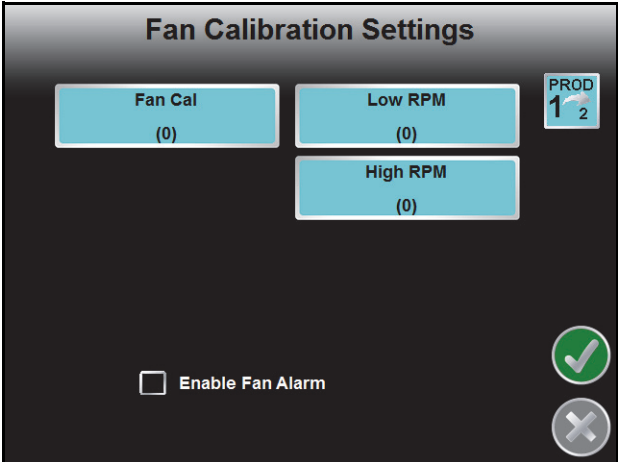

Fan Cal. Touch the Fan Cal button and use the on-screen keypad to enter the number of pulses detected by the fan speed sensor per revolution of the fan.

Low RPM. Enter the lowest acceptable fan speed before the field computer will display an alert.

High RPM. Enter the highest acceptable fan speed before the field computer will display an alert.

Enable Fan Alarm. Select the fan alarm option to sound an audible alarm if the fan speed falls below the low RPM setting or rises above the high RPM setting.

Metered Weight

Touch the Metered Weight button to start the meter roller calibration process.

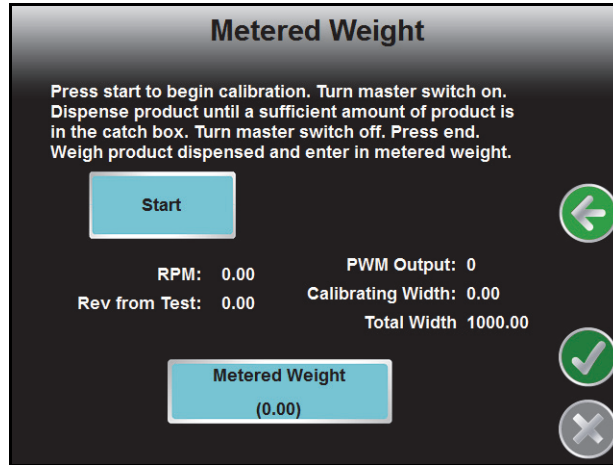

To perform a catch test:

Note: A catch test may be performed using the remote tank console. Refer to the Remote Calibration Console section on page 238 for details on using the remote tank console with the OmniSeed system.

1. Be sure the master switch and all section switches are in the off position.
2. Place the weight box below the appropriate bin to avoid dumping product on the ground.
3. Touch the Start button on the Metered Weight screen and toggle the master switch and at least one section switch to the on position.

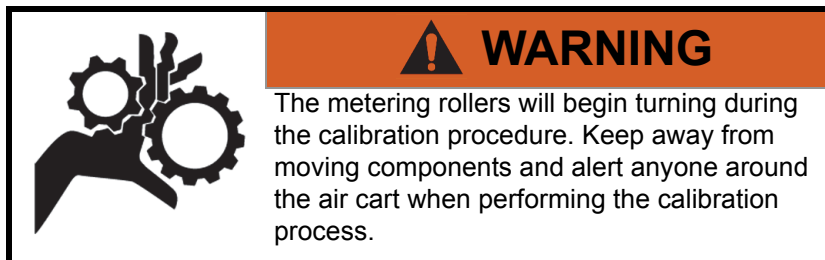

4. Continue dispensing product until a sufficient weight is in the weight box or the weight box is full.
5. Press the Stop button and toggle the master switch to the off position.
6. Weigh the product dispensed (minus the weight box).
7. Touch the Metered Weight button and use the on-screen keypad to enter the weight of the product in the units displayed on the keypad.
8. Touch the Accept icon in the lower, right corner of the screen to save the entered weight and return to the Calibration Settings screen.

Section Setup

The section set up for most seeder systems will require manual entry of offsets for sections based upon the relative location of seed control or any optional liquid sections.

Note: Review the Section Setup section on page 148 for details on using the Section Setup Wizard.

FIGURE 1. OmniSeed Granular and Liquid Section Configuration Example

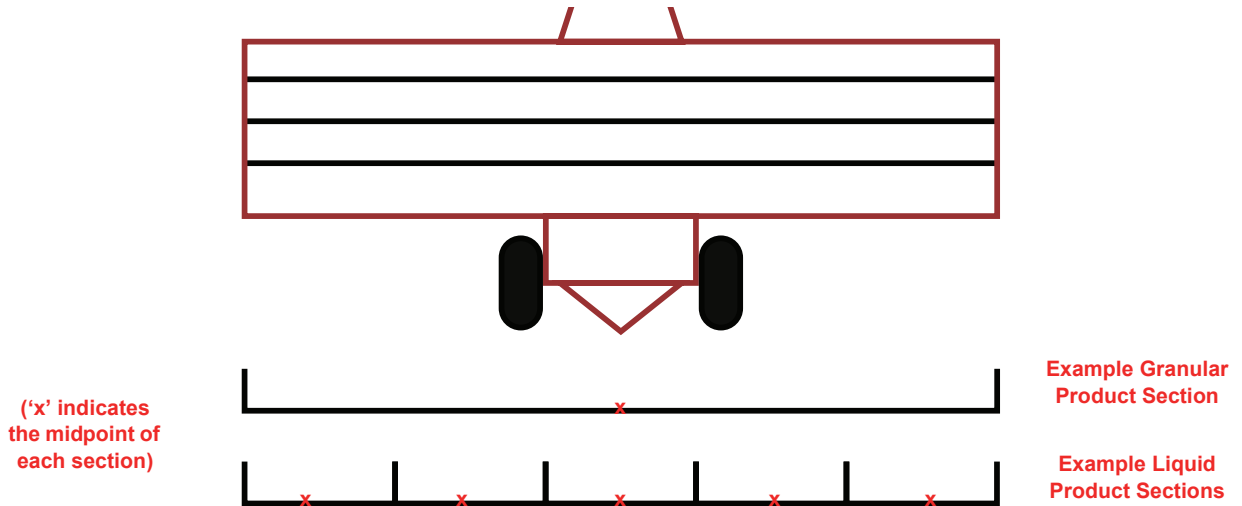

To configure the seeder implement sections, use the Manually Configure option on the Configure Sections screen.

When the section setup is complete for the seeder implement, the Section Configuration screen should display an abstract layout of the seeder implement as shown in the figure below.

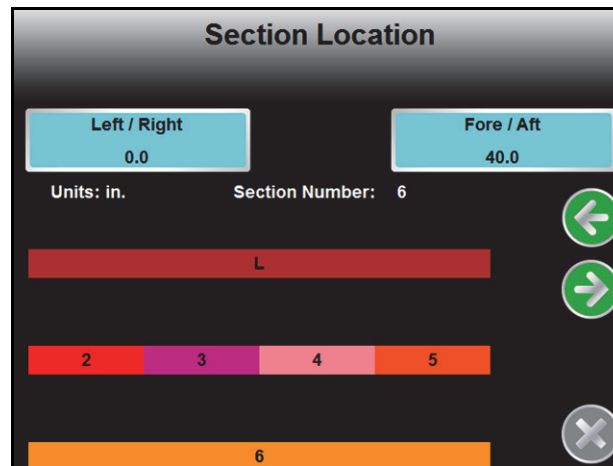

Section Assignments

Sections must be assigned to the appropriate products to ensure that the field computer creates accurate coverage maps during field operations. To configure section assignments on the Envizio Pro:

1. From the field computer Home screen, select the Tools Menu icon.
2. Select the Product Control icon from the System menu.

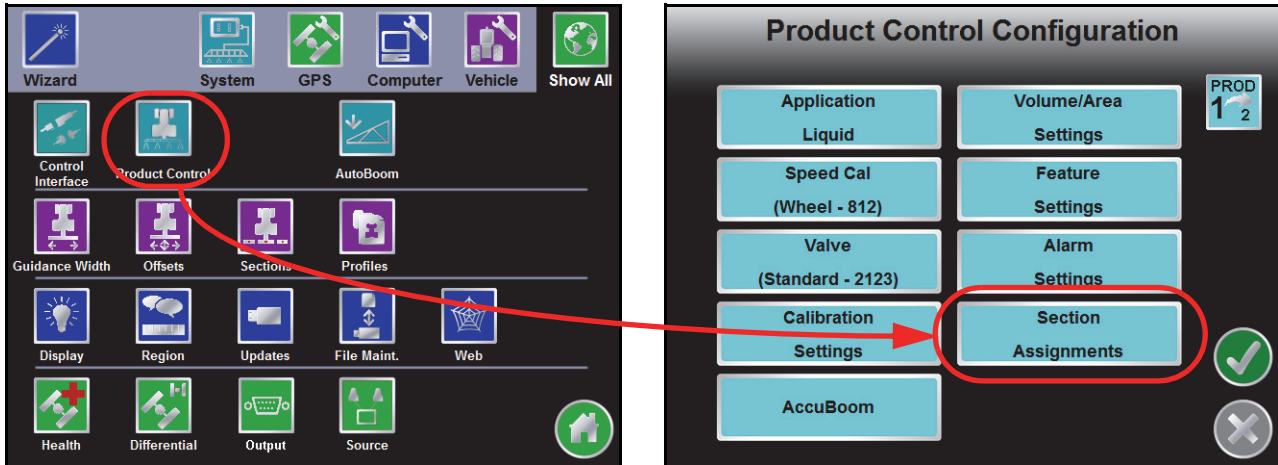

3. Select the Section Assignments button to display the Section Assignments screen.

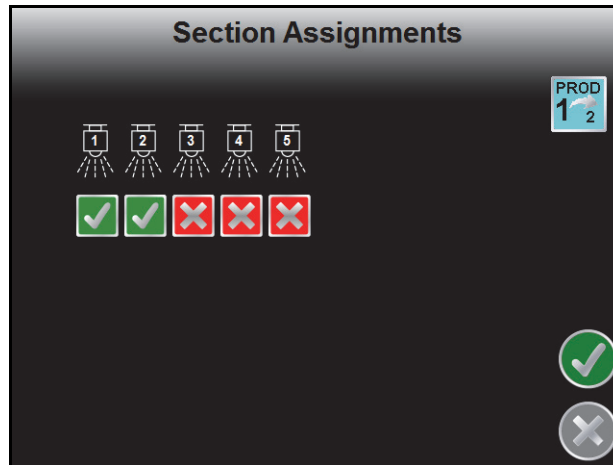

4. Touch the indicator below each section to place a check mark to assign the product to the section or a red 'x' to disable the product for the assigned section.

Section Switch Mapping

The Envizio Pro provides the ability to customize the section control switch functions as necessary for various seeder configurations with or without liquid control sections. This capability allows the operator to control a full seeder and application system using a 10 section switch box or to customize switch functionality to control multiple sections with one switch.

For Example:

Map liquid product sections 1 and 2 in the figure below to section switch 1 to control both liquid sections using the same section switch.

FIGURE 2. OmniSeed Section Numbering

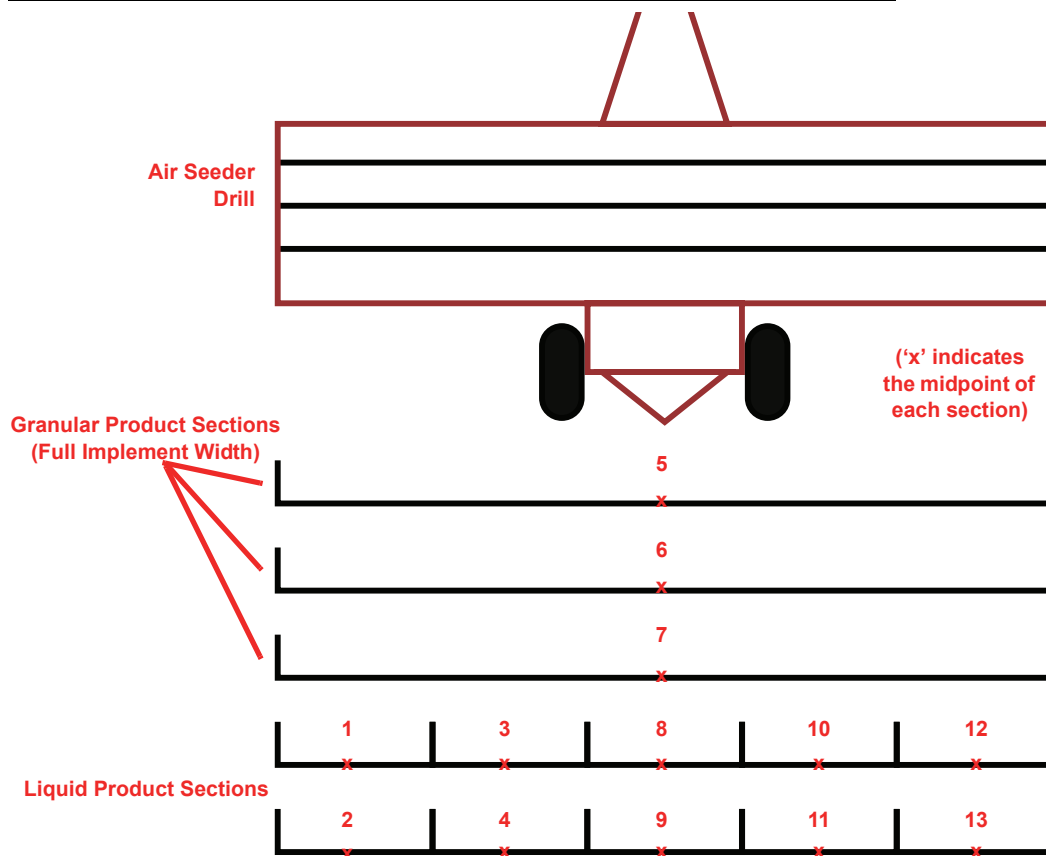

Bin Level Sensor Calibration

Capacitive Bin Level Sensors

The Raven OmniSeed system utilizes capacitive low bin level sensors to ensure products are available in each bin for the seeding operation.

Note: *The field computer monitors the capacitive low bin level sensors for low bin alarm and bin chaining conditions. If the field computer does not display an alert or the bin chaining feature does not operate as expected, the low bin level sensors may require recalibration.*

It is recommended to check the low bin level sensors on occasion and recalibrate the sensors as necessary. To calibrate the low bin level sensors:

FIGURE 3. Capacitive Low Bin Level Sensor

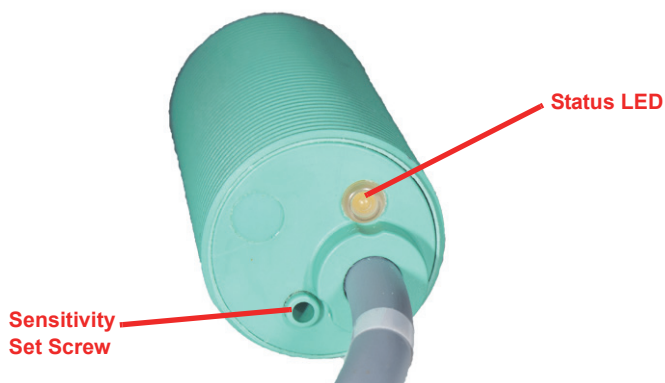

1. With an empty bin, check that the sensor status LED is off.
 - a. If the LED is on and the bin is empty, check the sensor inside the bin and clean as necessary.
 - b. If the LED is still on, adjust the sensitivity set screw until the LED extinguishes.
2. Fill the bin to a level to cover the bin level sensor. If the LED illuminates after the bin is filled, no further adjustment is required. It may be possible to fine tune the sensor for the specific crop, however, the following steps are only necessary should the low bin level sensor sends intermittent or false alarms during seeding operations.
3. With the sensor covered, the sensor LED should be on.
 - a. If the LED is off, adjust the sensitivity set screw until the LED illuminates. Turn the sensitivity set screw an addition quarter to half turn.
 - b. If the sensor displays intermittent or false bin level alarms during operation, adjust the sensitivity set screw until the status LED is extinguished. Reverse the set screw a quarter to half turn and verify the status LED is illuminated.

Optional Ultrasonic Bin Level Sensors

The Raven OmniSeed system features optional ultrasonic bin level sensors which automatically detect the level of product remaining in each bin. The bin sensor for each of the first three products must be calibrated to accurately gauge the amount of product in the bin.

Note: The air cart bins must be empty to calibrate the bin level sensors.

1. Touch the Tools Menu icon and select the Product Control icon from the System menu.



2. Next, select the Volume/Area Settings button from the Product Control Configuration screen.
3. Touch the Bin Level button to display the Bin Height Calibration screen.

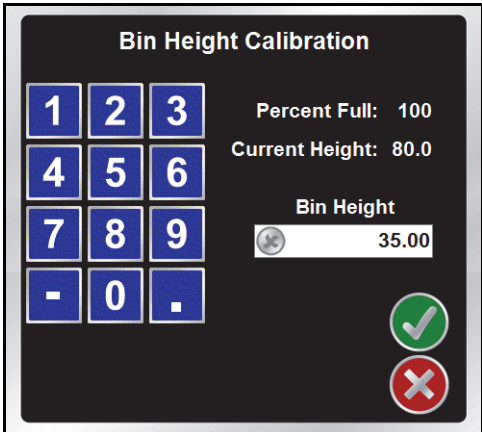

4. Use the on-screen keypad to enter the height of the bin (in inches [centimeters]) when empty. The field computer will use the overall height to determine the percent of product remaining in the bin during field operations.

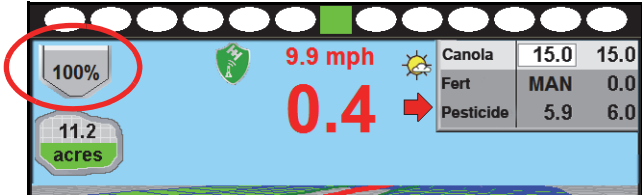

Remote Calibration Console

The optional tank calibration kit (P/N 117-0171-302) allows the operator to perform all the necessary calibration operations from the air cart making calibration of the OmniSeed system quick and convenient. The remote tank console allows the operator to prime metering rollers and perform the catch test while watching the air cart operation which can help the operator make correct system adjustments prior to starting a seeding operation in a field.



WARNING

The metering rollers will turn during the calibration procedure. Keep away from moving components when performing a catch test using the remote tank console.

Be aware of bystanders and alert anyone around the air cart when performing the calibration process.

Note: *When performing calibration with the remote tank console, the Envizio Pro field computer must be powered up. To ensure that the tank console programs the system properly, the field computer should not be used to navigate the calibration screens or the meter weight settings. The tank calibration kit requires a hydraulic drive system to connect the remote tank console.*

Kit Contents

TABLE 1. Remote Tank Calibration Kit (P/N 117-0171-302)

| Part/Description | Part Number |
|-------------------------------|--------------|
| Console, Remote Tank | 063-3001-004 |
| Cable, Remote Tank Calibrator | 115-3001-039 |

Console Connection

Note: *The remote tank console and cable should only be connected when using the console to calibrate the system. Remove the remote tank console and console cable and replace the dust cap when storing or operating the air cart.*

To connect the remote tank console:

- Carefully insert the round 4-pin connector on the calibrator cable to the 4-pin port on the back of the tank console. Be sure to line up the keyway on both the port and connector before securing the connector.
- Carefully insert the round 8-pin connector on the calibrator cable to the 8-pin port on the back of the tank console. Be sure to line up the keyway on both the port and connector before securing the connector.
- Locate the 6-pin Deutsch connector labeled 'Remote Cal' on the air cart control cable. The 'Remote Cal' connector should be located on the left side of the air cart near the metering rollers.
- Remove the dust cap from the 'Remote Cal' connector and insert the 6-pin Deutsch connector on the calibrator cable.

Console Power

Press the blue power button to power up the remote tank console.



If the console does not power up, check that all connections are secure and that the field computer is powered on.

Note: *The current program and software version numbers will be displayed while the console initializes during power up. Have these numbers available when contacting technical support.*

To shutdown the remote tank console, press and hold the blue power button for approximately 3 seconds.

Remote Tank Console Operation

The remote tank console allows the operator to prime metering rollers, adjust valve response, perform a catch test and enter the cal weight all while observing operation of the air cart to ensure proper operation of the OmniSeed system.

Priming

To accurately calibrate the OmniSeed system for operation, the metering rollers must be primed and the meter RPM set prior to performing the catch test. The operator may prime the metering rollers using the remote tank console. To prime the metering rollers:

Note: *Place the weight box below the appropriate bin to avoid dumping product on the ground. The metering rollers will not stop automatically. Do not leave the remote tank console until the process is complete and the metering rollers have stopped rotating.*

1. With the remote tank console powered up, use the Next and Prev keys to select the desired bin and press the Enter key.



2. Press the Begin key to start the bin calibration.

3. Press the Enter key again to select the 'Prime Meter Roller' option and press the **Start** key.



WARNING

The metering rollers will begin turning during the priming procedure. Keep away from moving components and alert anyone around the air cart when performing the priming process.

4. Allow the metering roller to rotate until a consistent amount of product is dispensed and then press the Stop key.



If necessary, use the INC or DEC keys to increase or decrease the PWM Output, or speed, of the metering roller during the priming process.

Note: *The PWM Output, or metering roller speed, will also be used for the catch test procedure, however, the output may not be adjusted during the calibration. Be sure to set the PWM Output during the priming process to ensure the best results.*

5. A catch test may now be performed with the primed bin. To return to the Bin Calibration screen, press the Back key. To return to the Bin Selection screen, press Back, Prev, and Exit.

Catch Test

To perform a catch test and determine the cal weight for seeding operations, perform the following procedures:

Note: *Place the weight box below the appropriate bin to avoid dumping product on the ground. The metering rollers will not stop automatically. Do not leave the remote tank console until the process is complete and the metering rollers have stopped rotating.*

1. With the remote tank console powered up, use the Next and Prev keys to select the desired bin and press the Enter key.



2. Press the Begin key to start the bin calibration.
3. Press the Next key to select the 'Start Calibration' option and then select the Enter key.

4. Press the Start key.



 **WARNING**

The metering rollers will begin turning during the calibration procedure. Keep away from moving components and alert anyone around the air cart when performing the calibration process.

5. Continue dispensing product until a sufficient weight is in the weight box or the weight box is full.
6. Press the End key to complete the calibration.

Note: Press the Stop key during the calibration process to pause the calibration and stop the metering rollers if necessary. While paused, press Start key to resume the catch test. It is recommended to run the catch test without pausing the calibration to get the most accurate results.

Press the Cancel key to stop the calibration process and return to the calibration screen without entering a cal weight.

7. Weigh the product dispensed (minus the weight box) and proceed to the *Cal Weight* section to complete the calibration process.

Cal Weight

The Metered Weight Page will display automatically at the end of the catch test procedure. This screen displays the number of metering roller revolutions detected during the catch test and allows the operator to enter the weight of product dispensed to calibrate the OmniSeed system. To enter the cal weight value:

1. Use the Left and Right keys to move the cursor below the bin cal weight value to the first digit of the measured cal weight and press the Enter key.



2. Press the INC or DEC keys to set the appropriate value for the selected digit and press the Enter key to set the value.



3. Repeat the above procedure to set the remaining cal weight digits up to two decimal places.

4. To program the cal weight value, press the Right key to move the cursor past the last decimal place in the cal weight value and press the Send key.



The remote tank console will send the entered cal weight value to the appropriate control node and will return to the bin calibration screen.

5. Press the Exit key to return to the bin selection screen.

Using the Tank Console To Adjust Settings

The following settings may be entered using the remote tank console. Settings will be stored in the appropriate nodes on the OmniSeed system and will be registered by the field computer when starting OmniSeed application for seeding operations.

To adjust settings for a specific bin or product:

1. With the remote tank console powered up, use the Next and Prev keys to select the desired bin and press the Enter key.
2. Press the Setup key to display the current settings for the selected bin.
3. The following settings will be available on the first settings screen:



Note: Use the Next or Prev keys to move the cursor between the screen options. Pressing the Prev key on the decimal shift option will return to the bin calibration screen. Press the **Next** key on the cal weight option to advance to the second settings screen.

Decimal Shift. Press the Toggle key on the decimal shift option to turn the decimal shift feature on or off.

Enable the decimal shift feature to increase the system accuracy for low application rates. In the standard mode, the remote tank console and field computer will display values to one decimal place. With the Decimal Shift feature enabled, values will be displayed to two decimal places.

Note: When the field computer is initialized, all of the calibration values will need to be verified after the Decimal Shift feature is either enabled or disabled. Change settings as necessary.

Meter Cal. Press the Enter key on the meter cal option to edit the current meter cal value. The meter cal value is the number of counts the metering roller sensor will detect per revolution of the metering roller.

Use the INC or DEC keys to adjust the meter cal value and press the Enter key to set the meter cal value.

Note: *It is recommended to enter a meter cal of 60 when using the Envizio Pro for the hydraulic drive system.*

Cal Weight. Press the Enter key on the cal weight option and use the INC or DEC keys to adjust the set cal weight value. The cal weight value to set the cal weight sets the weight of product applied per revolution of the metering roller.

Refer to *Catch Test* section on page 240 and the *Cal Weight* section on page 241 for details on using the remote tank console to calculate the cal weight value.

4. Press the Next key on the cal weight option to advance to the next settings screen.



Note: *The second settings screen is only accessible if the valve type for the selected product bin is set to PWM or PWM close. Refer to the Valve section on page 103 for detailed information on valve type selections.*

The following settings are displayed on the second settings screen:

Note: *Use the Next or Prev keys to move the cursor between the screen options. Pressing the Prev key on the PWM frequency option will return to the previous settings screen. Press the Next key on the min PW option to exit the settings menu and return to the bin calibration screen.*

PW Freq. Press the Enter key and use the INC or DEC keys to set the coil frequency of the PWM valve. The default value for hydraulic drive systems is 122 Hz.

Min PW. Press the Enter key and use the INC or DEC keys to set the minimum desired RPM or hydraulic output (zero point or shutoff point) for a Pulse Width Modulated (PWM) control valve.

Max PW. Press the Enter key and use the INC or DEC keys to set the maximum desired RPM or hydraulic output (zero point or shutoff point) for a Pulse Width Modulated (PWM) control valve.

Note: *Refer to PWM Calibration Screen section on page 107 for details on using the calibration assistance to calculate the Min and Max PW values.*

Troubleshooting

| Issue | Possible Cause | Solution |
|--|--|--|
| Remote tank console will not power on | <ul style="list-style-type: none"> Field computer not powered on | <ul style="list-style-type: none"> Power on the field computer. |
| | <ul style="list-style-type: none"> Power not provided to remote tank console | <ul style="list-style-type: none"> Check and reconnect 6-pin Deutsch connector. Check and reconnect 4-pin round connector on the back of the remote tank console. Check and reconnect air cart cable to chassis connection. |
| Meter rollers do not turn when priming or calibrating. | <ul style="list-style-type: none"> Hydraulics to air cart are not powered on. | <ul style="list-style-type: none"> Turn hydraulics to air cart on and check pressure. Verify there is no debris or blockages in the hydraulic circuit. |

Error Messages

| Issue | Possible Cause | Solution |
|---|--|--|
| Check air cart node or CAN communication | <ul style="list-style-type: none"> Power/ground issue with air cart node(s). | <ul style="list-style-type: none"> Check the power and ground connections on air cart nodes. Check CANbus system connections and reconnect nodes. |
| No nodes have been found. Verify power to node and CAN connection | <ul style="list-style-type: none"> Nodes not powered or faulty logic power connection | <ul style="list-style-type: none"> Check CANbus system connections and reconnect nodes. |
| | <ul style="list-style-type: none"> CAN nodes not connected to controller. | <ul style="list-style-type: none"> Verify hitch connections and check CANbus system connections. |
| Can not calibrate, note enough meter revolutions. Press any key | <ul style="list-style-type: none"> Valve PWM output insufficient for system measurement | <ul style="list-style-type: none"> Increase PWM output during priming procedure. Verify PWM or PWM close valve type is selected for the selected product(s). Be sure the min and max PW values are programmed correctly. Refer to the <i>PWM Calibration Screen</i> section on page 107 for more information. |

APPENDIX

J

Serial Console Interfaces

Interface the Envizio Pro with the Bogballe Calibrator Zurf, Kuhn/Rauch LH5000, or Amazone Amatron+ console to add the data-logging, mapping, and 2D/3D guidance features to current system operations. If the single product variable rate key (P/N 077-0180-031) has been activated on the Envizio Pro, the field computer may be used to variable rate product application via the existing serial console.

Note: When connected with the Bogballe Calibrator Zurf console, the Envizio Pro is capable of performing AccuBoom, automatic section control, features during field operations. An AccuBoom control node is not required to enable the AccuBoom feature on the field computer in this configuration.

Console Connection

Connect the COM2 connector on the field computer interface (P/N 115-0171-746) or chassis interface (P/N 115-0171-926) cable with the Calibrator Zurf, LH5000, or Amatron+ serial input via a null terminated serial cable (P/N 115-0171-040 or 115-0159-822).

FIGURE 1. Connecting the Envizio Pro and Serial Control Console

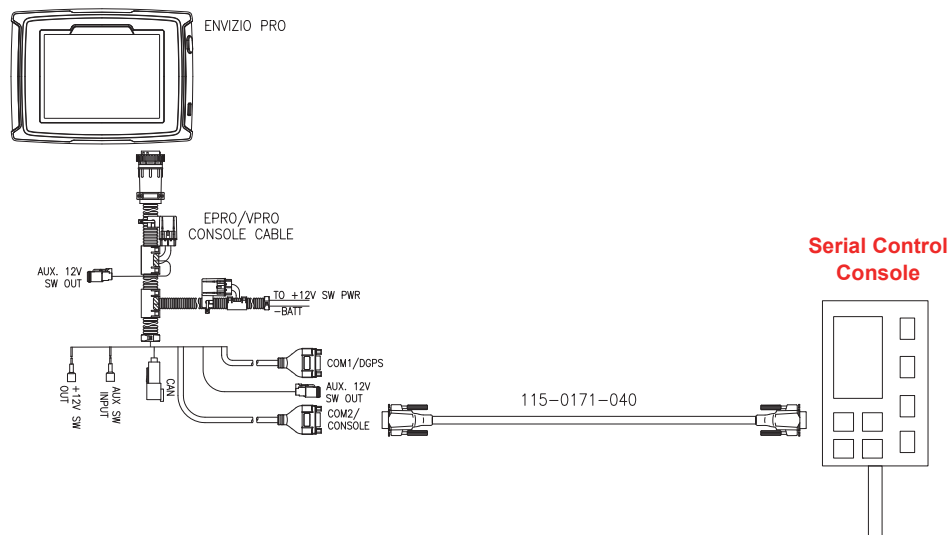

Connect the speed interface cable to send GPS speed from the field computer to the serial control console.

Serial Control Setup and Configuration

Note: When the Envizio Pro is setup to interface with the Bogballe Calibrator Zurf, LH5000, or Amatron+ console, the “Profiles” feature within the field computer will be disabled.

1. From the field computer Home screen, touch the Tools Menu icon.
2. Touch the Control Interface icon within the System submenu.
3. Select “Bogballe Calibrator Zurf,” “Rauch LH5000,” or “Amazone Amatron+” from the product control options list.

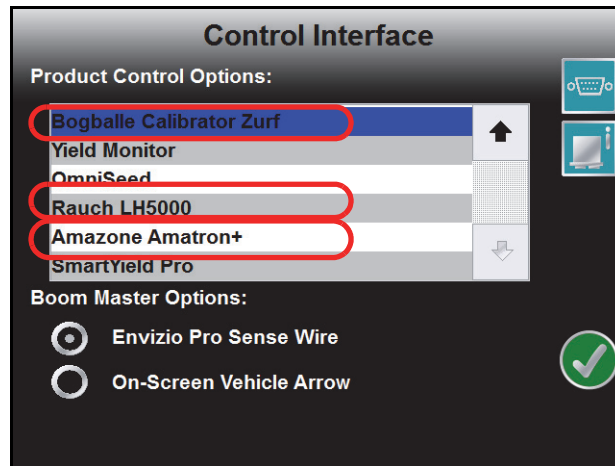

4. Touch the green check mark icon to return to the main Tools Menu screen.

Section and Guidance Width Configuration

Note: The field computer automatically configures a section width to the spread width value programmed into the serial control console. Any changes to the spread width value on the console will immediately affect the section width on the field computer.

1. From the field computer Home screen, touch the Tools Menu icon.
2. Select the Guidance Width icon within the Vehicle submenu.
3. Use the on-screen keypad to enter the desired swath or spread width in inches [centimeters]. The field computer uses the programmed guidance width to determine guidance paths.
4. Touch the green check mark icon to return to the main Tools Menu screen.

Antenna Offsets

To ensure accurate mapping and application control, configure the GPS antenna offsets in the field computer Tools Menu.

1. Determine the spread distance using the appropriate spread chart.
2. Measure the distance from the GPS antenna to the spinners.

Note: The Fore/Aft value must be measured parallel with the vehicle direction of forward travel.

3. Add the measured antenna offset and the spread distance together to determine the total offset value.

FIGURE 2. Offset Distance Calculation

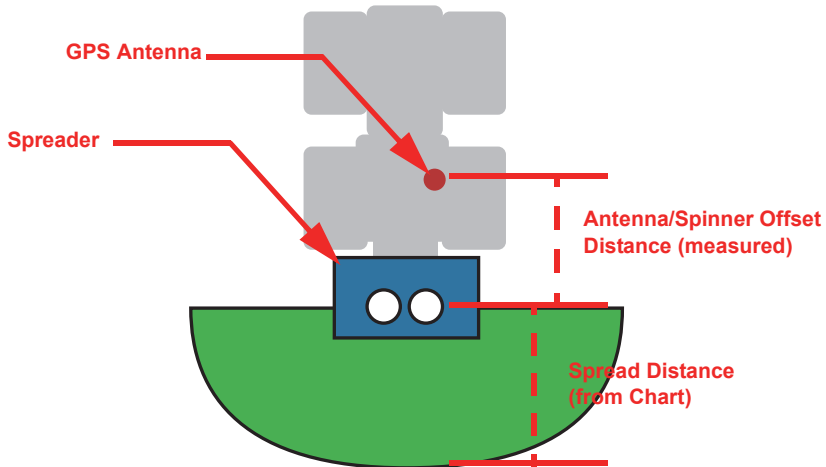

- 4. From the field computer Home screen, touch the Tools Menu icon and select the Offsets icon from the Vehicle submenu.

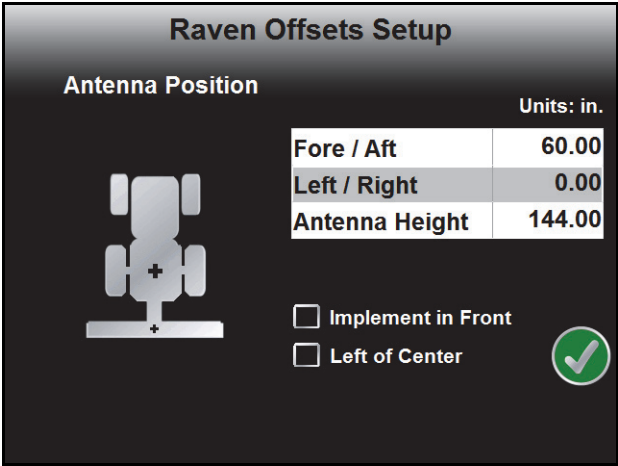

- 5. Touch the Fore/Aft value on the Offsets Setup screen and use the on-screen keypad to enter the calculated total offset value.

Note: The values entered for the fore/aft value must be entered in the same units as shown above the fore/aft offset value.

AccuBoom™ Configuration

Note: *AccuBoom, automatic section control, features are only available for the Bogballe Calibrator Zurf serial interface.*

The turn-on/turn-off look-ahead values may be adjusted after this procedure is completed to customize AccuBoom performance to the specific vehicle and spreader.

Use the following procedure to calibrate the AccuBoom turn-on and turn-off look-ahead values to the spreader:

1. From the field computer Home screen, touch the Tools Menu icon and touch the Product Control icon within the System submenu.
2. On the Product Control Configuration screen, select the AccuBoom button to display the AccuBoom Configuration screen.

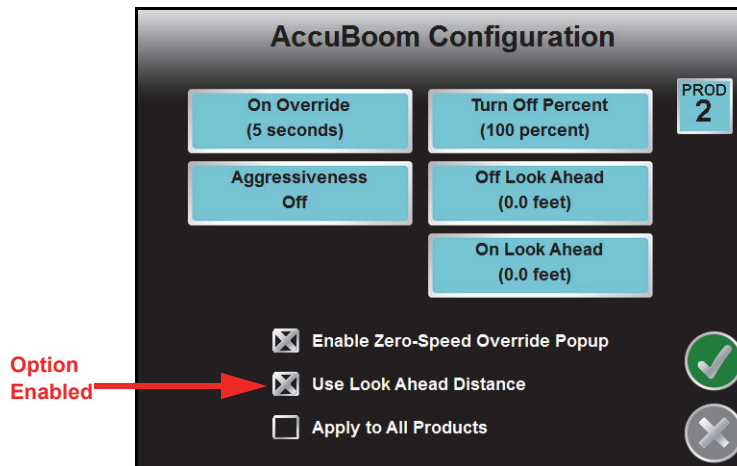

3. Enable the “Use Look Ahead Distance” option at the bottom of the screen by touching the box until a check is displayed.
4. Touch the Off Look Ahead button and use the up or down arrows to set the off look-ahead value to the spread distance value determined from the appropriate spread chart.
5. Touch the green check mark to return to the AccuBoom Configuration screen.
6. Touch the On Look Ahead button and use the up or down arrows to set the on look-ahead value to zero.

Note: *The procedure above will configure the AccuBoom system for general operation with the spreader. To fine tune AccuBoom performance for the specific system and the specific vehicle, adjust the look-ahead values in small increments until the desired performance is achieved.*

See Chapter 9, Using AccuBoom™, for more information on setting up and operating the AccuBoom feature on the field computer.

Operation

When interfacing with the Calibrator Zurf, LH5000, or Amatron+ console, the field computer displays the user entered target rate and actual rate from the serial control console in the upper, right corner of the Guidance screen.

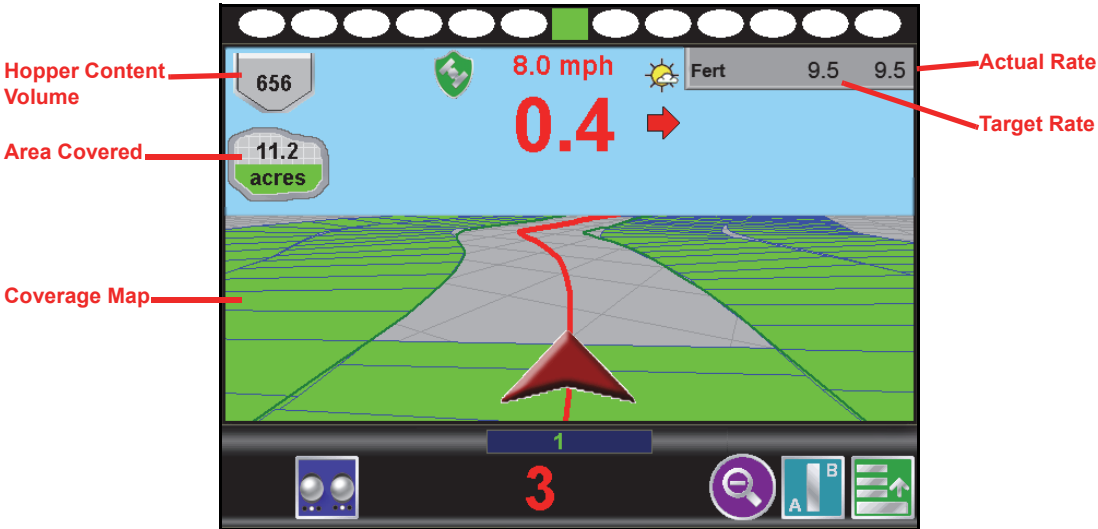

Hopper Contents

The current hopper content volume registered by the Calibrator Zurf console will be displayed in the hopper content volume display on the field computer Guidance screen. For volume displays with the LH5000 or Amatron+, use the standard bin volume features as explained in *Tank or Bin Indicator* section on page 67.

Area Covered & Coverage Mapping Information

The coverage map and area covered information on the field computer Guidance screen are based on the GPS location recorded by the field computer.

Application Reports

While interfacing with a Calibrator Zurf, LH5000, or Amatron+ console, the field computer records coverage area based upon GPS coordinate data. The coverage area in a field may then be output from the field computer on an application report for use on a home or office PC.

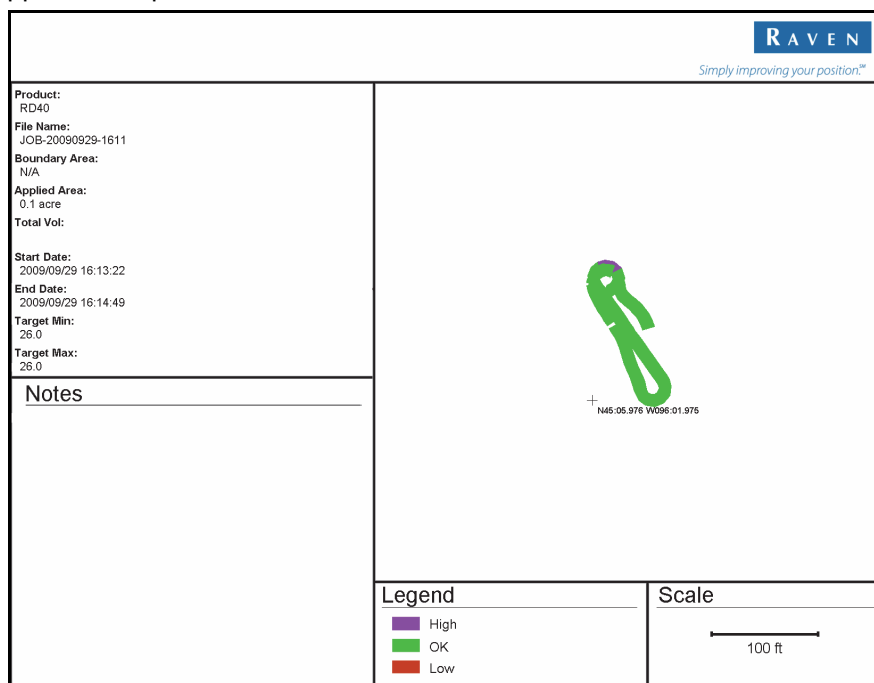

Note: No field or total volume information is recorded by the field computer while interfacing with the serial control console.

Automatic Variable Rate

If the single product variable rate key (P/N 077-0180-031) is activated, the field computer will send target rate information to the serial control console for automatic variable rate control and application.

K

Navigation

The following icons will be used to navigate within the menu screens and to edit and save settings.



Touch the Home icon when it appears to return to the Home screen. Any active jobs will continue in the background. Note that some Tools Menus will not be accessible while a job is in progress.



Touch the Accept icon to confirm any changes to a screen. Touching the Accept icon will save those settings and proceed to the next screen.



Touch the Cancel icon to exit the screen without saving any changes made on a screen. If the Cancel icon is displayed in gray, the cancel feature is not available.



Like the Accept icon, the Next icon accepts changes and proceeds to the next screen in a setup procedure. Touch this icon where it appears to access more settings or to continue a setup procedure. The last screen in a setup procedure should display the Accept icon.



Touch the Previous icon to return to the last screen displayed during a setup procedure or wizard.



The Up icon, where it appears, increases displayed values in preset increments. Touch this icon to increase a value until the desired value is displayed.



The Down icon, where it appears, decreases displayed values in preset increments. Touch this icon to decrease a value until the desired value is displayed.



Touch the Create New icon when it appears to create and rename new job related files.

Note: Names of jobs, vehicle profiles, guidance lines or boundary maps stored on the field computer cannot begin or end with a space.



Product 1 Selected



Product 2 Selected

The Cycle Product icons are used when more than one product is connected to the CANbus system. The Cycle Product icons indicate for which product information is currently being displayed. Touch the icon to cycle the selected product to access settings or display information for additional product nodes or control channels connected to the CANbus system.

Home Screen

The Home screen offers access to the following features of the field computer:



Touch the Start Job icon to begin a new job, select a previous job or to return to the Guidance screen if a job is already in progress.



Touch this icon to access the Tools Menu. The Tools Menu is only available from the Home screen. Refer to Chapter 7, *Tools Menu*, for information about settings and using the Tools Menu.



If a job is in progress, the End Guidance icon will appear on the Home screen. Touch this icon to end the active Guidance session.



When the console is powered on or when Guidance is not active, the Shutdown icon will be displayed. Raven recommends using the Shutdown feature before pressing the power button.

Information

Touch the information icon in the upper, right corner of the home screen to display the software and image versions currently installed on the field computer.



GPS Status

The current source and status of DGPS signal is displayed in the upper, left corner of the Home screen.



Note: The standard GPS shield will be displayed if the Envizio Pro field computer cannot determine the type of corrections being sent from the DGPS receiver.

The status icon on the Home screen will display:

- Green if the status of GPS is okay.
- Yellow if an error condition has been encountered.
- Red if GPS is non-functional. Make sure the DGPS antenna cable connections are secure and the antenna has a clear, 360° view of the sky.

RTK Fixed and Float Modes

When using an RTK correction source with the internal dual frequency GPS receiver, the GPS status indicator may be used to determine whether the receiver is operating in RTK fixed or float modes. The RTK shield will display:

- Green to indicate a fixed RTK position. This mode indicates that the receiver has a full RTK position fix and is providing sub-inch corrections. The GPS Health screen will display a value of 4 for the differential mode when operating in RTK fixed mode.
- Yellow to indicate that the receiver is operating in RTK float mode. This mode indicates that the receiver is not able to provide a full RTK position lock due to the distance from the base station, visibility of the sky, time of day or interference around the base station location. In the float mode, the receiver is still providing a course RTK correction signal, but accuracy of the receiver may not be at a sub-inch level. The GPS Health screen will display a value of 5 for the differential mode when operating in RTK float mode.

Direction of Travel



The last direction of travel detected by the field computer is displayed on the screen when setting up a job on the field computer and may also be found on the GPS Health screen by selecting the GPS Status icon.

If the direction of travel displays incorrectly during a field application, touch the direction of travel icon to manually toggle the course over ground.

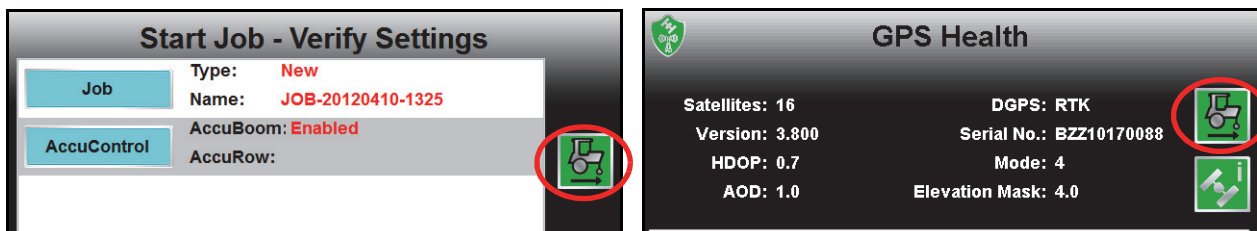

Wireless Communications Status

The current status of wireless communication is displayed along the top of the Home screen display.



This icon will appear:

- Gray if no wireless communications device is connected to the field computer.
- Green if communication is okay.
- Yellow if an error condition has been encountered.
- Red if wireless communication is not available.

Touch the shield icon to display the Wireless Status screen. Refer to the Appendix C, *Wireless Communications & Remote Service* for more information.

Tools Menu

The following icons may be found within the Quick Access Bar at the top of the Tools Menu screen.



The Setup Wizard Menu is available in the Tools menu. Review the *Setup Wizards* section on page 42 for more details on using the setup wizards.



Access the System Menu to setup the product control system or configure the optional AccuBoom or AutoBoom systems.



The GPS Menu contains screens to setup the internal GPS receiver or to enable the field computer to use signal from an external receiver. The GPS menu also contains screens to review the status of GPS reception, set message outputs (for the internal DGPS receiver only), setup an optional TM-1 Tilt Module or select the PRN.



The Computer Menu sets display and feature settings of the field computer. Access the Computer menu to change the display brightness, language and units, adjust the on-screen or external light bar, as well as activate features or update the field computer software.



Access the Vehicle Menu to setup or modify vehicle profiles for each machine or implement with which the field computer will be used. Profiles allow the operator to setup GPS antenna heights and offsets as well as the swath width and section setup for each implement once and quickly reload a vehicle's profile when transferring the field computer between vehicles.



Select the Show All icon to show an overview of the Tools menu. The Show All screen is displayed each time the Tools menu is accessed.

File Maintenance

To begin file maintenance from the Home screen:

1. Touch the Tools Menu icon.
2. Select the File Maintenance icon within the Computer menu.

Note: Before performing file maintenance with a new USB flash drive, set up the required file structure on the connected USB flash drive by selecting the icon shown to the right.



3. Select the type of files to transfer from the list at the top of the screen.

Note: Verify that all desired file types (report, shapefile, Slingshot) are selected in the Configure File Output screen.

4. Touch one of the following icons to select the direction in which to transfer files.

From Field
Computer



To Field
Computer



Transfer From Field Computer



Select left icon to transfer a selected file to the connected USB flash drive or the right icon to transfer all files of the selected type currently saved on the field computer.



Select the left icon to export the Slingshot® data package for a selected job file to the connected USB flash drive or the right icon to export data packages for all job files currently stored on the field computer



Select the left icon to delete a selected file from the field computer or the right icon to delete all files of the selected type currently saved on the field computer.



Note: The Delete button will not affect any files on the flash drive. To remove files from the flash drive, use the PC's file browser (i.e. Windows Explorer) to remove, delete or copy files from the flash drive.



Touch this icon to manually initiate upload of a selected file currently stored on the field computer via a SlingShot® Field Hub and available wireless connection.

Note: Refer to Appendix C, Wireless Communications & Remote Service, for more information on transferring files using the Slingshot service.

Transfer To Field Computer



Select the left icon to transfer a selected file to the field computer or the right icon to transfer all files of the selected type currently stored on the USB flash drive.



CAN Diagnostics



Touch this icon to readdress product control nodes connected to the CANbus. Readdressing product control nodes may be necessary if a node is not detected by the field computer. Verify that the node is properly powered and connected to the CANbus communication lines before readdressing the product control nodes. See the *Readdressing Product Nodes* section on page 31 for more information.



Select this icon to reset all product control nodes to their default values. Use the *Calibration Reference Sheet* section on page vii if necessary to record the required calibration values for system operation. To help record additional settings for each node, step through or review the *Product Control Setup Wizard* section on page 44. After resetting nodes, it is recommended to run the Product Control Setup Wizard to reconfigure each product node or control channel.



Touch this icon to retry CAN communications. If a node is not recognized when starting up the field computer, restarting CAN communication may allow the system to recognize the node without further troubleshooting steps. If a node is still not detected, additional troubleshooting or readdressing the CANbus may be required. Refer to the *CAN Troubleshooting* section on page 34 or *Readdressing Product Nodes* section on page 31 for additional information.



Touch this icon to update CAN nodes via the field computer. Review Appendix E, *Updating CAN Nodes via the Envizio Pro*, for more information on obtaining node update files and performing an update via the field computer.



Detailed node hardware information is available by selecting a node listed on the CAN Diagnostics screen and touching this icon. The hardware summary screen provides node operating information that may be helpful when contacting technical support or while troubleshooting CAN communication issues.

Note: *If the node is not capable of providing hardware information, the Hardware Summary screen will display "N/A" for the unavailable diagnostic values.*



The Raven product controller node is capable of providing up to four product control channels on an Envizio Pro control system. By default, the product controller will make two control channels available to the field computer for controlling product application.

Select one of the product controller node channels and select the Select Channels icon (shown to the left) to set the number of control channels available via the node.

Note: *The Select Channels icon will display the current number of channels which the node is providing to the field computer. Each control channel must be configured separately via the Tools Menu.*

Guidance Patterns

The following icons represent the available Guidance patterns available for use with the field computer.



The Enhanced Last Pass is well suited to provide guidance for irregular swaths due to irregular field boundaries, well heads or waterways, etc.



The Straight (A-B) Line pattern is useful for applications in fields with row crops.



The Pivot pattern is useful for applications in fields irrigated by a center pivot.



The Fixed Contour pattern is ideal for creating and saving swaths which follow irregular field boundaries, waterways, well heads, etc., or where the ability to skip swaths in an irregular pattern is necessary. Refer to the *Using Guidance Patterns* section on page 63 for more information on using Guidance patterns.

Guidance Screen

The following icons and tools are displayed on the Guidance screens.



The Vehicle Arrow represents the vehicle's position in the field. The Vehicle Arrow may also be used to toggle coverage mapping if the correct master switch option is selected. Refer to the *Product Control* section on page 99 for more information about this feature.



Touch the Menu icon in the lower right corner of the Guidance screen to display a menu of available views and tools.



Within the Menu, touch the Home icon to return to the Home screen. Any active jobs will continue in the background until the job is ended. Note that some Tools Menus will not be accessible while a job is in progress.

Guidance Views

The following views may be selected for viewing the Guidance screen. To select the desired view, access the Menu on the Guidance screen and touch one of the following icons.



Touch this icon to display the Down Field view. The Down Field view is the view displayed when starting or resuming Guidance from the Home screen.



Touch this icon to switch to a Bird's Eye view. The Bird's Eye view follows the vehicle's current position with a view looking down onto the vehicle indicator.



Touch this icon to switch to the field review mode. The field review mode can be used to review the entire as applied map.

On-Screen Switch Box



The section or master switch is off. The control system will not control any sections or rows if the section switch is in the off position. If the master switch is toggled off, the control system will shut off product application for all rate control sections or rows.

On the Guidance screen, the master switch icon will display off if all sections are in the manual off position.



Sections or master switch is on. If the master switch is toggled on, the control system will not automatically shut off sections or rows.

On the Guidance screen, the master switch icon will display on if all sections are in the manual on position.



The On/Off icon will be displayed if at least one section is in the manual on position and at least one section is in the manual off position.



Sections or master switch is in the automatic position. The control system will automatically turn on or turn off rate control sections or rows based upon previous coverage, field boundaries or zone maps during field operations.

This icon is only displayed on the Guidance screen if all sections are set to the automatic control mode.

Note: *Touch the master off, automatic or on icons to toggle all sections currently set to automatic control. Tapping the master switch indicator will toggle any sections currently in the automatic mode to the selected status. Tap the automatic mode will toggle those sections back to automatic while leaving any manually controlled sections to the assigned mode.*

Double tap the master switch icon to toggle all section switches to the selected status.



Touch the AccuBoom timed override icon within the on-screen switch box to override AccuBoom controlled sections for the time entered as the on override time. Refer to the *On Override* section on page 164 for more information.



If available, touch the Liquid icon displayed in the upper, right corner of the on-screen switch box display to toggle to the Liquid Shutoff Sections Override screen. This screen allows the operator to manually override the liquid shutoff sections on or off.

To allow the control system to automatically control the liquid shutoff sections based on the seed application sections, set the liquid section switches to the automatic position. Toggle the switch on or off to override automatic control and keep the liquid section(s) on or off as desired. The automatic section control feature will not automatically shut off liquid sections that are not in the automatic position.

Note: *When connected to an Envizio Pro field computer, the OmniRow system requires the Raven auxiliary planter node to control and map liquid product and liquid product sections during field operations.*

Without the auxiliary planter node, the field computer may still be used to shutoff liquid sections based upon seed rate control sections. All seed rate control sections or rows must be off before the liquid section will automatically shut off. If any seed rate section, group or row is enabled and active, the corresponding liquid section will remain on.



If available, touch the Plant icon to toggle the on-screen switch box to the AccuRow Override control screen. Use the switches on this screen to manually override seed rate control sections, groups or rows. To allow AccuRow to automatically control section status, set all section switches to the automatic position.

Field Review Mode Tools

The following icons appear in the field review mode.

Pan Lock



When the pan lock is disabled, the display will automatically scroll to the vehicle indicator as the indicator moves out of the current view. Disable the pan lock to always display the vehicle indicator while in field review mode.



When the pan lock is enabled, the display is locked to the current view regardless of the vehicle indicator position. The operator can manually pan and zoom with the pan lock enabled to view specific portions of a field while in field review mode.

To Pan the display Manually, touch the Field Review screen. Touch the screen to pan the center of the field review display to the selected location.

Show Overlaps



With the show overlaps feature disabled, the field review mode displays the covered areas (including overlaps) in a solid green color. Touch this icon to toggle the show overlaps feature.



When the show overlaps feature is enabled, application overlaps are displayed in red. Overlaps appear where application (i.e. active boom sections) cover previously applied areas. Note that the area covered will not display as an overlap unless product application has overlapped.

Drift Shift



The drift shift feature allows the operator to manually adjust, or nudge, the reported GPS position of all features (e.g. boundaries, coverage and zone maps, field markers, and guidance lines, etc.) within the job simultaneously. This feature allows the operator to manually correct for GPS drift over the course of a field operation or to “recalibrate” the position of field features if the job is resumed at a later date or time.

Field Markers



Field markers allow the operator to mark locations such as well heads, rock piles, or points of interest during a field operation. Markers will be displayed during the operation and will allow the operator to view the marker information.

Toggle Maps on the Guidance Screen

During a job with an active prescription or zone map, the field computer will display either map on the Guidance and Field Review screens. If both a prescription map and a zone map will be used, the operator may toggle which map to display on the guidance and field review screens by selecting the toggle maps icon.

To toggle the displayed map, touch:



The view zone map icon to view the loaded zone map.



The view prescription map icon to display the loaded prescription map on all guidance displays.

A-B Path Tools

The following tools and features may be found in the Menu when the Straight Line, Fixed Contour or Pivot guidance patterns are active.

Loading an A-B Line



If an A-B Line has been saved on the field computer, touch the Load A-B Line icon to load a saved line into the current job. This icon will not appear if an A-B Line has already been set. Reset the line to access the Load A-B Line tool.

Note: *The A-B Line must be stored in the field computer internal memory to be able to access and load the guidance path. Be sure to transfer all necessary files to the field computer before beginning a job.*

A-B Lines stored on the field computer cannot begin with a space.

Setting A-B Points

To create a New A-B Line, the operator must set A and B points. The following icons and tools may be used to set a New A-B Line.

Touching the Set A icon will place the first, or A, point of the path at the vehicle's current location. Regardless of where the vehicle moves from this point, the field computer will use the selected pattern to connect this point with the next set point. After the Set A icon is selected, the Set B icon will appear.

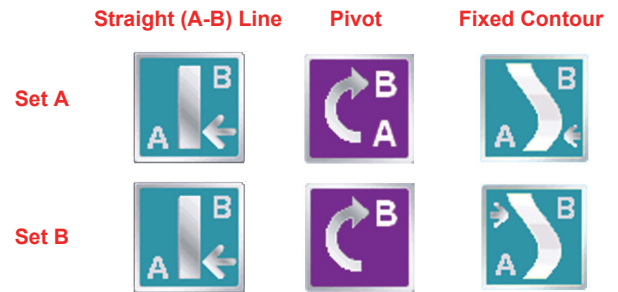

Touch the Set B icon to place the second, or B, point of the guidance path. Once the B point has been set, the field computer will use the selected Pattern to create the Guidance Path displayed on the Guidance screen.

Set B by Heading

The Set B by Heading feature is only available with the Straight Line Guidance Pattern. This feature allows the operator to set an A-B Line before completing the first swath.



Use the Set B by Heading feature to create a guidance path along a heading. Touch this icon and use the displayed keypad to enter a heading between 0° and 359° (with 0° being due North).

A-B Path Configuration

The following tools are available in the Menu when a compatible A-B Line is displayed on the Guidance screen.



Select the A-B Tools icon to access additional tools for use with the current A-B Line.



Select the Reset A-B Line icon to clear the displayed path. If the displayed path will need to be recalled in the future, be sure to save the current path before selecting reset.



Touch the Save A-B Line icon to save the displayed path. Once saved, an A-B Line can be recalled at any time or loaded into other jobs. In addition, saved paths can be transferred from the field computer via the File Maintenance feature. See Chapter 8, *Software Updates and File Maintenance*, for details on the File Maintenance feature and transferring saved paths.



Use the Re-calibrate A-B Line tool to re-calibrate the displayed path to the machine's current position. Due to DGPS drift over time, this feature allows the operator to re-calibrate the A-B Line to a known position in a field.

Nudge Feature

The Nudge Feature allows the operator to fine tune the displayed path for actual field conditions. The Nudge Feature works especially well with the Raven SmarTrax assisted steering systems. Contact a local Raven dealer for more information about these systems.



During an active job, touch the Menu button and select the Edit Nudge icon to display the In Job Nudge Settings screen. This screen allows the operator to enable the on-screen nudge controls, adjust the nudge values and select the active nudge applied when the nudge icons are selected. See the *Nudge Feature* section on page 75 for more information on setting up and using the Nudge Feature.

On-Screen Nudge Enabled

The following icons will be displayed on the Guidance screen if the on-screen nudge controls option is set to Enabled.



Touch the Nudge Right icon to move the displayed guidance path to the right. The distance which the path will be nudged is determined by the user defined value for the Active Nudge.



Touch the Nudge left icon to move the displayed guidance path to the left. The distance which the path will be nudged is determined by the user defined value for the active nudge.

A-B Tools Menu Nudge

The following nudge icons appear in the Menu on the Guidance screen. Touch the Menu icon and select the A-B Tools icon to access the following nudge tools.



Touch the Nudge Right icon in the A-B Tools menu to move the guidance path to the right in 1 inch [2 cm] increments.



Touch the Nudge Left icon in the A-B Tools menu to move the guidance path to the left in 1 inch [2 cm] increments.

Field Boundary Tools

The following icons will be used while creating a field boundary.



Touch the Boundary Tools icon to display boundary tools available for the current job.



A previously recorded boundary can be loaded into the current job file by selecting the Load Field Boundary icon in the Menu. A list of files stored on the field computer is displayed. Select the desired field boundary to load the selected field boundary into the current job.



Touch the Delete Boundary icon to reset the current field boundary. A field boundary must be present in the current job or this icon will not appear in the Menu.



Touch the Record Field Boundary icon to begin recording a new field boundary. While a field boundary is being recorded, the Pause and End Field Boundary icons are displayed on the Guidance screen.

Pause, Resume and End Boundaries

The following icons will appear on the Guidance screen while a field boundary is being recorded.



Touch the Pause Boundary icon to pause recording of the field boundary. Use this feature when the vehicle's path will not reflect the boundary such as when re-filling tanks, etc. To resume recording, touch the Resume icon.



While paused, the Resume Boundary icon replaces the Pause and End Boundary icons on the Guidance screen. Touch this icon to resume recording of the current boundary.



To finish recording a boundary, touch the End Field Boundary icon. Note: The field computer draws a straight line from the boundary starting point to the vehicle's current location when closing a boundary.

Alarms

Depending upon the alert or warning condition, the field computer may display one or more of the following icons:



The Product Control Alarm icon is displayed if an alarm condition such as a low bin or tank, or when product control cannot reach the target rate.



The AutoBoom Alarm icon is displayed if an alarm condition such as sensors too low or high, the pressure is higher than the set point or if a sensor has gone off line. Refer to Chapter 10, *Using AutoBoom®*, for more information about the optional Glide Series AutoBoom system and troubleshooting AutoBoom alarms.



Touch the Show All Alarms icon to view all current alarm conditions.

AccuBoom™

The following tools and icons will be displayed when working in a job with the AccuBoom feature enabled.



Select the zone mapping tools to display AccuBoom and zone map tools available for the current job. Tools displayed in this menu may only appear if certain map features are present within the current job. Read the descriptions of the following tools for more information regarding when the tool or feature is available.



While editing zone maps, the Home button is replaced with the Accept button. To save the currently displayed map and restore normal Menu tools, select the Accept button.



Touch the Record No-Spray Zone icon to begin recording points along a no-spray zone boundary. The area inside of the completed boundary will become a no-spray zone.



Touch the Record Spray Zone icon to begin recording points along a spray zone boundary. The area inside of the completed boundary will become a spray zone.



Touch the Record Field Boundary icon to create a new AccuBoom field boundary. With zone mapping mode enabled, AccuBoom will assign a minimum of three boom widths outside of the completed boundary as a no-spray zone.

On-Screen Tools

While recording a zone map feature, the following icons may be displayed on the Guidance screen.

Pause

Select the Pause button displayed on the Guidance screen to temporarily interrupt recording the current zone map feature.



This feature is useful if the vehicle course will move away from the boundary path to refill a tank, etc.

Resume

While Paused, a Resume button will replace the Pause and End buttons on the Guidance screen. Touch this button to resume recording the paused zone feature.



Stop

When finished recording a Zone or Boundary, touch the Stop button to close Zone or Boundary.



Note: *The field computer will draw a straight line from the starting point of the feature to the machine's current location when closing the zone map feature.*

AutoBoom®



The AutoBoom Off icon is displayed when the feature is turned off. Touch this icon to toggle AutoBoom On. Automatic boom height management cannot be Enabled if AutoBoom is Off.



The AutoBoom On icon is displayed when the feature is turned on. Touching this icon will toggle the feature Off. Important: Each boom must be Enabled before the Glide Series AutoBoom will automatically control boom height.

AutoBoom® Status Indicator



The AutoBoom Off indicator is displayed when the AutoBoom feature is turned off. Boom height management is not enabled.



The AutoBoom On/Disabled indicator is displayed when the AutoBoom feature is On but boom height management is not enabled.



The AutoBoom On/Left Enabled indicator displays when AutoBoom is On and boom height management is only Enabled for the left boom. AutoBoom will not adjust the height of the right boom.



The AutoBoom On/Right Enabled indicator displays when AutoBoom is On and boom height management is only Enabled for the right boom. AutoBoom will not adjust the height of the left boom.



The AutoBoom On/Enabled indicator displays when AutoBoom is On and boom height management is Enabled for both booms.

Note: *If operating with an UltraGlide AutoBoom system, the set Sensor Height is displayed in the Status Display. If an optional center rack sensor is installed, the actual height of the center rack will be displayed in this area.*

A**A-B Path Tools** 73**AccuBoom™** 163

- Creating a Zone Map 174
- Enable Override Popup 167
- Enabling 167
- Examples of Zone Maps 176
- Loading a Field Boundary 172
- Look Ahead 167
- Mapping Tools 173
- Modes of Operation 169
- On Override 164
- Setup 164
- Turn Off Percent 166
- Zone Maps 172

Alarm Settings 116**Alarms** 87**Applying Software Updates** 162**AutoBoom™** 179

- Operation 180
- PowerGlide Plus 179
- Status Display 180
- Turning On the AutoBoom™ Feature 180
- UltraGlide 180

B**Boom Cal** 190, 199**Boom Sections** 147**C****Calibration**

- Additional Data 202
 - Entering Bin Level 202
 - Entering Tank Volume 202
 - Volume/Area Display Information 202
- Granular Applications
 - Product Density 200
 - Rate Cal 200
 - Spreader Constant 199

Calibration Settings 109**Calibration Values**

- Boom Cal 147, 190, 199
- Calculating 187
- Fan or Pump Cal 110
- Granular Applications 199
- Liquid Applications 190
- Meter Cal 109, 191
- Pressure 1 and 2 Cal 111
- Product Density 109
- Rate Cal 110, 196
- Speed Cal 102, 187
- Spinner Cal 109
- Spinner RPM 201
- Spreader Constant 111
- Valve Cal 194
- Valve or Flow Cal 103

CAN (Controller Area Network)

- Connections 27
- Troubleshooting 34, 186

CAN Diagnostics 30, 98**CAN Nodes**

- Diagnostics 30

- Off-line Errors 34
- Readdressing 31
- Retry CAN Communication 32
- Version Information 31

CANbus Diagnostics 29**Care and Use** 11**Computer Menu** 135

- Applying Software Updates 162
- Demo Mode 140
- Display 135
- File Maintenance 140
- Region 137
- Updates 14, 138, 160

Configuring Section Labels 150**Connecting External DGPS Receiver****Systems** 22**Creating a Zone Map** 174**D****Demo Mode** 140**Display** 135**E****Electrical**

- Safety 2

Enabling AccuBoom™ 167**Enhanced Last Pass** 64**Envizio Pro**

- Startup 38

Envizio Pro Features

- See *Features*

Error Messages 185

- GPS 186
- Job 185

F**Features** 4

- Front Panel 8
- Internal DGPS Receiver 5
- On-Screen Guidance 5
- Optional Features 7
- Rear Panel 10
- Speed Compensated Product Control and Datalogging 4

Field Boundaries 80**Field Boundary Tools** 81**Field Review Mode Tools** 78**File Maintenance** 140, 154

- File Outputs 154
- Performing 155

File Structure 158**Fixed Contour** 65**G****GPS Menu** 120

- Differential 125
- e-Dif 126
- GPS Health 122
- Output 131
- Source 133

GPS Status 52

Guidance Patterns

- Fixed Contour 65
- Last Pass 64
- Pivot 66
- Straight (A-B) Line 65

Guidance Screen 62

- Features 62
 - AutoBoom™ Status Display 180
 - Menu 72
 - On-Screen Rate Bump buttons 71
 - Pressure or Fan Speed Display 71
 - Product Rate Display 68
 - SmarTrax Status 63
 - Tank or Bin Level Indicator 67

Guidance Views 72

- Field Review Mode 78

Guidance Width 141

H

Height 144

Home 72

Home Screen 51

Hydraulic

- Safety 2

I

Important Safety Information 1

- Electrical 2
- Hydraulics 2

In Job Product Configuration 69

Initial Setup 37

Initial Startup

- Wizard 40

Installation 15

- DGPS Antenna 21
- External DGPS Receiver Systems 22
- Mounting the Field Computer 17
- Optional Equipment 23
 - AutoBoom™ 27
 - Light Bar 25
 - Serial Console 26
 - SmarTrax™ 26
 - TM-1 Tilt Sensor 25

- Overview 15

Introduction

- Unit Definitions and Conversions viii
- Unit of Measure Conversions viii
- Unit of Measure Definitions viii

J

Job Error Messages 185

Job Files 55

Jobs

- AccuControl Setup 59
- AutoBoom™ Setup 61
- Product Setup 59
- Resume an Existing Job 58
- Setting up a Job 56
- Start a New Job 58
- Starting a Job 56

K

Kit Contents 16

M

Master Pressure 166

Menu 72

Meter Cal 109, 191

Mounting the Field Computer 17

N

Node Version Information 31

O

Overview of the Installation Process 15

P

Performing File Maintenance 155

Pivot 66

Prescription (Rx) Settings 112

Prescription Maps 85

- Applying Prescription Maps 86
- Loading Prescription Maps 85
- Using Prescription Maps 87

Pressure 1 and 2 Cal 111

Product Control Features 66

Product Control Options 94

Product Density 109

Product Rate Display 68

Pump or Fan Cal 110

R

Rate Bump 111

Rate Cal 196

Rate Cal 110

Readdressing the Nodes 31

Reference of Icons

- A-B Path Tools 260
- AccuBoom™ 264
- Alarms 264
- AutoBoom™ 266
- Field Boundary Tools 263
- Field Review Mode Tools 259
- GPS Status 253
- Guidance Patterns 257
- Guidance Screen 257
- Guidance Views 258
- Home Screen 252
- Navigation 251
- Tools Menu 254

Region 137

Retry CAN Communication 32

Rx Settings

- See Prescription (Rx) Settings

S

Screens

- Guidance Screen 62

Home Screen 51
Section Assignments 119
Serial Port Configuration 98
Setup Wizard Menu 42
 AutoBoom™ Setup Wizard 49
 Product Control Setup Wizard 44
 Section Setup Wizard 43
Special Features Registration 138
Speed Cal 102, 187
Spinner Cal 109
Spreader Constant 111
Straight (A-B) Line 65
System Menu 93
 AutoBoom™ 120
 Control Interface 94
 Light Bar 136
 Product Control 99

T

Tank or Bin Level Indicator 67
Test Speed 102
Testing Cables
 Flow Meter 204
 Speed Sensor 203
Tiered Boom Settings 111, 197
Time Zone Settings 137
Tools Menu
 Computer Menu 135
 Special Features Registration 138
 GPS Menu 120
 Navigation 91
 Show All 152
 System Menu 93
 Tilt Sensor 134
 Vehicle Menu 141
Touch Screen Calibration 39
Troubleshooting 183
 Coverage Map Issues 185
 General Issues 183
 Job Issues 184
 Setup Issues 184

U

Updates 14, 138, 160
 Special Features Registration 138
 Time Zone Settings 137
Updating 215
Using Guidance Patterns 63
Using Zone Maps 172

V

Valve 103
Valve Cal 194
Variable Rates 85
Vehicle Menu 141
 Boom Sections
 Section Setup 148
 Guidance Width 141
 Height 144
 Offsets 142
 Sections 147

Verifying Flow Rate Limits 110
Volume
 Bin Level 113
 Tank Volume 113
Volume and Area Settings 113

W

Weather Station 211
 Configuration 212
 Connecting 212
 Overview 211
 Using the Weather Station 213

RAVEN

Limited Warranty

What Does this Warranty Cover?

This warranty covers all defects in workmanship or materials in your Raven Applied Technology Division product under normal use, maintenance, and service when used for intended purpose.

How Long is the Coverage Period?

Raven Applied Technology products are covered by this warranty for 12 months from the date of retail sale. In no case will the Limited Warranty period exceed 24 months from the date the product was issued by Raven Industries Applied Technology Division. This warranty coverage applies only to the original owner and is non-transferable.

How Can I Get Service?

Bring the defective part and proof of purchase to your Raven dealer. If the dealer approves the warranty claim, the dealer will process the claim and send it to Raven Industries for final approval. The freight cost to Raven Industries will be the customer's responsibility. The Return Materials Authorization (RMA) number must appear on the box and all documentation (including proof of purchase) must be included inside the box to be sent to Raven Industries.

What Will Raven Industries Do?

Upon confirmation of the warranty claim, Raven Industries will (at our discretion) repair or replace the defective product and pay for the standard return freight, regardless of the inbound shipping method. Expedited freight is available at the customer's expense.

What is not Covered by this Warranty?

Raven Industries will not assume any expense or liability for repairs made outside our facilities without written consent. Raven Industries is not responsible for damage to any associated equipment or products and will not be liable for loss of profit, labor, or other damages. The obligation of this warranty is in lieu of all other warranties, expressed or implied, and no person or organization is authorized to assume any liability for Raven Industries.

Damages caused by normal wear and tear, misuse, abuse, neglect, accident, or improper installation and maintenance are not covered by this warranty.



Extended Warranty

What Does this Warranty Cover?

This warranty covers all defects in workmanship or materials in your Raven Applied Technology Division product under normal use, maintenance, and service when used for intended purpose.

Do I Need to Register My Product to Qualify for the Extended Warranty?

Yes. Products/systems must be registered within 30 days of retail sale to receive coverage under the Extended Warranty. If the component does not have a serial tag, the kit it came in must be registered instead.

Where Can I Register My Product for the Extended Warranty?

To register, go online to www.ravenhelp.com and select Product Registration.

How Long is the Extended Warranty Coverage Period?

Raven Applied Technology products that have been registered online are covered for an additional 12 months beyond the Limited Warranty for a total coverage period of 24 months from the date of retail sale. In no case will the Extended Warranty period exceed 36 months from the date the product was issued by Raven Industries Applied Technology Division. This Extended Warranty coverage applies only to the original owner and is non-transferable.

How Can I Get Service?

Bring the defective part and proof of purchase to your Raven dealer. If the dealer approves the warranty claim, the dealer will process the claim and send it to Raven Industries for final approval. The freight cost to Raven Industries will be the customer's responsibility. The Return Materials Authorization (RMA) number must appear on the box and all documentation (including proof of purchase) must be included inside the box to be sent to Raven Industries. In addition, the words "Extended Warranty" must appear on the box and all documentation if the failure is between 12 and 24 months from the retail sale.

What Will Raven Industries Do?

Upon confirmation of the product's registration for the Extended Warranty and the claim itself, Raven Industries will (at our discretion) repair or replace the defective product and pay for the standard return freight, regardless of the inbound shipping method. Expedited freight is available at the customer's expense.

What is Not Covered by the Extended Warranty?

Raven Industries will not assume any expense or liability for repairs made outside our facilities without written consent. Raven Industries is not responsible for damage to any associated equipment or products and will not be liable for loss of profit, labor, or other damages. Cables, hoses, software enhancements, and remanufactured items are not covered by this Extended Warranty. The obligation of this warranty is in lieu of all other warranties, expressed or implied, and no person or organization is authorized to assume any liability for Raven Industries.

Damages caused by normal wear and tear, misuse, abuse, neglect, accident, or improper installation and maintenance are not covered by this warranty.