

# USER GUIDE

PORTABLE EV CHARGER



#### Manufacturer's Information

© 2017 AeroVironment, Inc. All rights reserved.

AeroVironment, EV Solutions, and the AeroVironment logo are trademarks of AeroVironment, Inc.

Corporate names, trademarks, registered trademarks, service marks, symbols, and logos stated herein are property of their respective companies.

Specifications are subject to change without notice. Images of the Dual voltage charger are representative; production models may vary. Dual voltage charger may be branded under different names.

No portion of these materials may be duplicated, used or disclosed without prior written permission from AeroVironment, Inc.

Disclaimer: This user guide includes the latest information available at the time of printing. AeroVironment, Inc. reserves the right to make changes to this user guide and/or product without further notice. Changes or modifications to this product not completed by an authorized service provider could void the product warranty.

#### Corporate Headquarters

AeroVironment, Inc.  
EV Solutions™

800 Royal Oaks, Suite 210  
Monrovia, CA 91016

Phone: 888-235-4969

Website: [www.ev solutions.com](http://www.ev solutions.com)

OWNER'S RECORD

model:

Portable EV Charger

serial number (s/n):

.....

purchase date:

.....

## A NOTE ON CUSTOMER SUPPORT

To ensure superior service, please take note of your Serial Number when contacting Customer Support.

Write down the Serial Number of your charger in the "Owner's Record" above. The Serial Number can be found on the bottom of the charger's plug-in module.

**Customer Support**  
**1-888-235-4969**

## SAVE THESE INSTRUCTIONS!

This manual contains important instructions for the MINI Portable EV Charger that shall be followed during installation, operation and maintenance of the unit.



## TABLE OF CONTENTS

SECTION 1: INTRODUCTION .....	1
Symbol Usage.....	2
About Your Portable EV Charger.....	3
Portable EV Charger Components .....	5
Required Outlets .....	6
SECTION 2: USING YOUR DUAL VOLTAGE CHARGER .....	7
Know Your Indicator Lights.....	8
Charging Your Vehicle .....	9
Manual Stop .....	11
A Note on Auto-Restart .....	11
SECTION 3: TROUBLESHOOTING .....	12
APPENDIX.....	16
Specifications .....	17
Installing the Wall Plate.....	18
High Voltage Warning.....	19
State of California Proposition 65 Warnings .....	20
FCC Information .....	20
Safety Features .....	20
Limited Warranty .....	22
Index.....	23

SECTION 1

# INTRODUCTION

## SYMBOL USAGE

DANGER		Indicates information about safety practices which, if not followed, may result in serious injury or death. .....
WARNING		Indicates information about safety practices which, if not followed, could result in personal injury or are necessary to prevent fire or equipment overheating. .....
NOTE		Indicates helpful information for installation or usage, but does not contain personnel or equipment safety related information.

# ABOUT YOUR PORTABLE EV CHARGER

Welcome to your MINI Portable EV Charger – our easy-to-use, compact, and portable power supply for your electric vehicle’s on-board charger. The charger supplies and manages AC power to your electric vehicle and is compatible with a variety of battery electric and plug-in hybrid electric vehicles.

The charger will operate from either a 120 VAC or a 208/240 VAC 60 Hz power source. The included adapter is required for 208/240 VAC operation.

## KEY FEATURES

- Dual voltage capability
- Compact, portable design
- Overheating protection
- Quick-read status indicators
- Underwriters Laboratories (UL) listed
- SAE J1772 compliant
- Auto-restart in event of ground fault or power outage

**120 VAC Operation:** the charger requires a 120 VAC single phase dedicated circuit. It draws a maximum of 12-amp continuous current and requires a 15-amp rated circuit breaker.

**240 VAC Operation:** the charger requires either a 240 VAC split phase, or a 208 VAC two phase dedicated circuit. It draws a maximum of 16-amp continuous current and requires a 20-amp rated circuit breaker.

WARNING



The adapter is designed for use with the charger in 208/240 VAC operating mode only. **DO NOT** connect other devices to the adapter. **NEVER** use the charger with any AC adapter except for the adapter supplied by the manufacturer specifically for use with this charger.

WARNING



It is recommended that electrical outlets for use with your charger be installed by a licensed, qualified electrician . To avoid serious injury or death, installation must comply with the provisions of the National Electric Code (NEC) and all local codes. In cases of conflict between local codes and the NEC, local codes shall take precedence.

WARNING



This product must be grounded. If it should malfunction or break down, grounding provides a path of least resistance for electric current to reduce the risk of electric shock. This product is equipped with a cord having an equipment grounding conductor and a grounding plug. The plug must be inserted into an appropriate outlet that is properly installed and grounded in accordance with all local codes and ordinances.

WARNING



Improper connection of the electrical outlet grounding conductor might result in a risk of electric shock. Check with a qualified electrician if you are uncertain whether or not the electrical outlet is properly grounded. Do not modify the plug provided with the product if it does not fit in the outlet. Have a proper outlet installed by a qualified electrician.

WARNING



Do NOT DROP charger or coupler.

DANGER



If the output cable becomes separated from the charger module or the charge coupler, DO NOT ATTEMPT TO REPAIR THE CABLE YOURSELF. Contact Customer Support for assistance.

WARNING



When using your charger, basic precautions should always be followed, including the following:

- See warnings on charger cord label. Read warnings before operating the unit the first time. Read all instructions in this guide before using this product.
- Never use the charger with an extension cord.
- Shock hazard – make sure the plug is fully inserted into the wall outlet so that there are no exposed blade surfaces.
- Children should be supervised when in the vicinity of the charger while plugged in.
- Do not put fingers into the electric charge coupler.
- To reduce the risk of fire, connect only to a circuit provided with 20 amperes maximum branch circuit overcurrent protection.
- Do not use in a commercial garage classified for internal combustion engine vehicles due to vapors of flammable liquids (gasoline) being present.

NOTE



The portable EV charger will not charge and will give a fault indication if ground is not present.



# PORTABLE EV CHARGER COMPONENTS

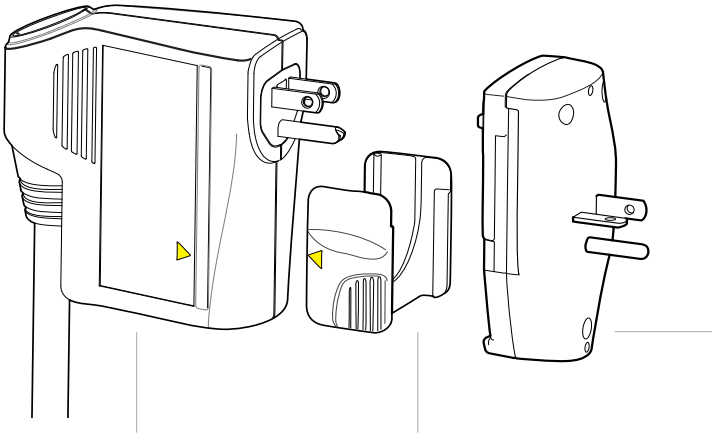

CHARGE MODULE

240V ADAPTER CLIP

240V ADAPTER

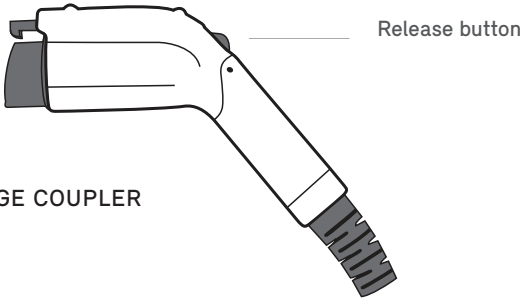

CHARGE COUPLER

Release button

RETAINING WALLPLATE

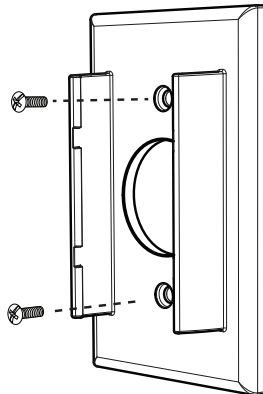

## REQUIRED OUTLETS

NOTE



Any electrical socket should be checked by an electrician.

120 VAC operation: a NEMA 5-15R wall outlet is required.



NEMA 5-15R wall receptacle  
120V

NOTE



A dedicated 120 VAC single phase circuit and a 15-amp rated circuit breaker are required.

208/240VAC operation: a NEMA 6-20R wall outlet is required.



NEMA 6-20R wall receptacle  
240V

NOTE



A dedicated 240VAC split phase circuit or a 208VAC two phase circuit and a 20 Amp rated circuit breaker are required.

SECTION 2

# USING YOUR PORTABLE EV CHARGER

# KNOW YOUR INDICATOR LIGHTS

The Indicator light on your charger is the first thing you will notice when you are about to plug or unplug your vehicle. Before we get started, here is a simple explanation of the indicators.

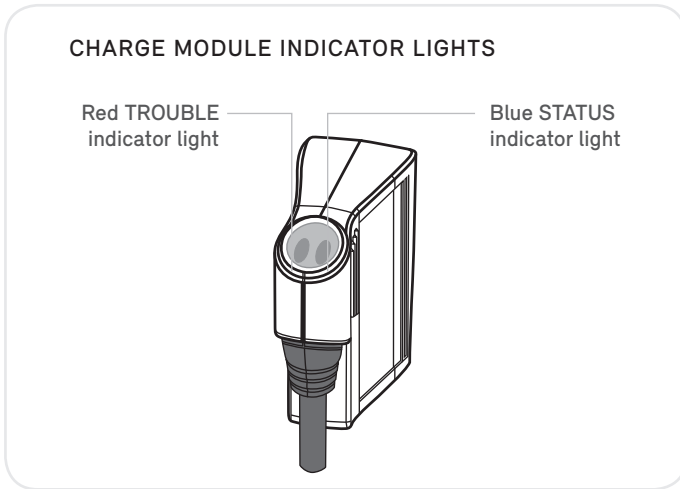

## BLUE: STATUS

When plugged into the wall outlet, the BLUE STATUS indicator illuminates to communicate that the charger is ready to use.

## RED: TROUBLE

The RED TROUBLE indicator illuminates when the charger has detected an error. If the RED TROUBLE indicator is illuminated, the charger will not deliver power to the vehicle. The error must be corrected before a charging cycle can begin or continue. Refer to the Troubleshooting Guide in Section 3 for more information.

### NOTE



A momentary blink of the RED TROUBLE indicator at first plug-in to the wall socket is normal and functions as a startup safety check. This momentary blink is followed by the solid BLUE STATUS Indicator and the RED TROUBLE indicator turns off.

### WARNING



A constant or blinking RED TROUBLE indicator indicates an actual problem.

## CHARGING YOUR VEHICLE

Your charger is designed for easy charging in in two modes – 120 VAC and 240 VAC.

### 120 VAC MODE

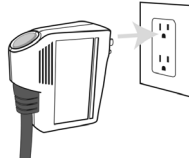

When used **WITHOUT** the ADAPTER, the charger connects to a 120 VAC outlet and charges your vehicle in “Level 1” charging mode. The Level 1, 120 VAC charge regimen takes longer to charge than the Level 2, 240 VAC mode; however, 120 VAC wall outlets are typically more readily available.

1. **Insert CHARGE MODULE** into appropriate 120V wall receptacle.

If the optional retaining wall plate is installed, the latches of the wall plate will snap into the grooves on the ADAPTER to reduce the chance of the CHARGE MODULE being accidentally pulled out of the wall outlet. Refer to the APPENDIX for installation instructions for the retaining wall plate.

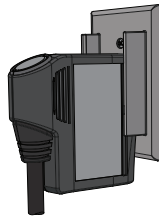

2. The **BLUE STATUS** indicator on the CHARGE MODULE should be ON. This means that the charger is ready to provide power to your vehicle.
3. **Plug** the CHARGE COUPLER into your vehicle’s charging receptacle until it clicks. If inserted properly, BLUE STATUS indicator will blink once. Once latched, the CHARGE COUPLER will not disengage unless the release button is pressed manually.
4. **Automatic charge begins.** Power will be delivered in accordance to vehicle demand. If the vehicle is charging, the BLUE STATUS indicator will blink on and off approximately every two seconds. Always verify that the vehicle charging status indicator agrees.
5. **When fully charged,** the BLUE STATUS indicator light illuminates solid blue. Your vehicle has a “dashboard gauge” which can verify that the vehicle is fully charged. Refer to the vehicle owner’s manual to find the gauge location on your dashboard.
6. **Disconnect** when the charge is complete by pressing the release button on the CHARGE COUPLER and removing it from the vehicle.

## 240 VAC MODE

When used WITH the ADAPTER, the charger can charge in Level 2, 240 VAC mode.

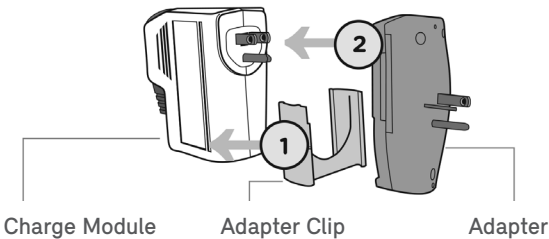

1. Snap the ADAPTER CLIP to the lower end of the CHARGE MODULE.
2. Insert the CHARGE MODULE into the ADAPTER (make sure it is fully inserted or the clip will not slide into the lock position).
3. Slide the ADAPTER CLIP up to the top of the CHARGE MODULE to lock in place.

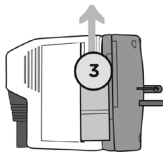

4. Insert the CHARGE MODULE with the attached ADAPTER into the appropriate 240 VAC wall outlet.

If the optional retaining wall plate is installed, the latches of the wall plate will snap into the grooves on the ADAPTER to reduce the chance of the CHARGE MODULE being accidentally pulled out of the wall outlet. Refer to the APPENDIX for installation instructions for the retaining wall plate.

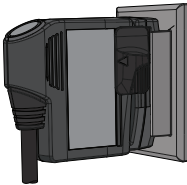

5. The BLUE STATUS indicator on the CHARGE MODULE should be ON. This means that the charger is ready to provide power to your vehicle.
6. Plug the CHARGE COUPLER into your vehicle's charging receptacle until it clicks. Once latched, the CHARGE COUPLER will not disengage unless the release button is pressed manually.
7. **Automatic charge begins.** Power will be delivered in accordance to vehicle demand. If the vehicle is charging, the BLUE STATUS indicator will blink on and

off approximately every two seconds. Always verify that the vehicle charging status indicator agrees.

8. **When fully charged**, the BLUE STATUS indicator light illuminates solid blue. Your vehicle has a “dashboard gauge” which can verify that the vehicle is fully charged. Refer to the vehicle owner’s manual to find the gauge location on your dashboard.

9. **Disconnect** when the charge is complete by pressing the release button on the CHARGE COUPLER and removing it from the vehicle.

NOTE



When plugging into an unfamiliar wall outlet, it is good practice to let the vehicle charge for several minutes before leaving it unattended, to ensure it is in fact supplying the expected AC charging power.

The RED TROUBLE indicator will illuminate if not charging. The unit will turn OFF if breaker or infrastructure GFI is tripped.

## MANUAL STOP

To safely stop charging at any time before charge completion, just press the CHARGE COUPLER release button and remove it from the vehicle.

Charging will automatically and safely stop.

BLUE STATUS indicator remains ON solid.

## A NOTE ON AUTO-RESTART

The Auto-Restart feature helps ensure that your vehicle will be charged and ready for use when needed. A charge may be interrupted if an error is detected. Charging will resume once the error is no longer detected. The RED TROUBLE indicator illuminates during an error condition.

The exception to immediate Auto-Restart is when the interruption is due to a charger GFCI event. The charger will attempt to restart 15 minutes after a GFCI event. After the fourth attempt to restart, the charger will shut down and the RED TROUBLE indicator will stay ON.

If the fault persists, do not continue to try to charge your vehicle. Contact Customer Support.

CHAPTER 3

# TROUBLE SHOOTING



## TROUBLESHOOTING

Please refer to this Troubleshooting Guide for possible solutions to common errors or difficulties with charging your vehicle using your portable charger.

NOTE



Do not attempt to repair or service the charger yourself. There are no user serviceable parts inside.

A RED TROUBLE indicator may be triggered by several sources, including the charger, the utility service, or the vehicle. See troubleshooting tips below.

The RED TROUBLE indicator turns on when the charger detects an error whether it is connected to your vehicle or not. With the RED TROUBLE Indicator on, the dual charger will not deliver power to the vehicle. The error must be corrected before charging begins or resumes.

Problem	Possible Cause	Solution
BLUE STATUS indicator does not illuminate	No power to unit	<ol style="list-style-type: none"> <li>1. Check circuit breaker and other circuit loads.</li> <li>2. Try another wall outlet.</li> <li>3. Ensure charger module (and adapter if operating in 240VAC mode) is fully inserted into the wall outlet.</li> </ol>
	Fuse blown in adapter	<ol style="list-style-type: none"> <li>1. Verify AC input is available. If yes, remove adapter; plug unit into a 120 VAC outlet and check charger to see if BLUE STATUS indicator illuminates.</li> <li>2. If BLUE STATUS indicator illuminates after removing adapter; fuse in adapter maybe OPEN. Replace adapter.</li> </ol> <p>Note: Determine the cause for the thermal fuse in adapter being open. The most common cause is often due to the receptacle being worn out and the connection is bad. If the receptacle is worn out or burnt, as indicated by discoloration around the socket, have a licensed, qualified electrician replace the receptacle immediately.</p>
	Charger internal failure	Contact Customer Support for assistance.
RED TROUBLE indicator remains solid	Charge coupler is not inserted into the vehicle	<ol style="list-style-type: none"> <li>1. Inspect the charge coupler.</li> <li>2. Remove the charge coupler from the vehicle, then reinsert it into the vehicle receptacle until it clicks.</li> </ol>
	Vehicle is not in a state to accept a charge	Verify vehicle charge timer is set to permit charging. Refer to the vehicle owner's manual for charge timer instructions.
	Communication error between charger and vehicle	Contact Customer Support for assistance.

Problem	Possible Cause	Solution
<p>RED TROUBLE indicator is blinking rapidly</p>	<p>Utility fault</p>	<ol style="list-style-type: none"> <li>1. Disconnect the charger module from the wall outlet, then reconnect to the wall outlet.</li> <li>2. If the condition persists, have a qualified electrician inspect the wall outlet ground circuit integrity.</li> <li>3. Repair as required.</li> </ol>
	<p>Above temperature limit</p> <p>Cases:</p> <ol style="list-style-type: none"> <li>1. Temperature is too high. The charger will restart charging when it cools down.</li> <li>2. House/socket wiring may be faulty.</li> </ol>	<ol style="list-style-type: none"> <li>1. Inspect charger module for overheating (hot to the touch).               <ol style="list-style-type: none"> <li>a. Carefully unplug charger module from the wall outlet and allow to cool.</li> <li>b. If the condition persists, contact Customer Support for assistance.</li> </ol> </li> <li>2. Disconnect the charger from the wall outlet.</li> <li>3. Have a qualified electrician inspect the wall outlet and adapter integrity.               <ol style="list-style-type: none"> <li>a. Repair as required.</li> </ol> </li> </ol>
<p>RED TROUBLE indicator is on solid when connected to vehicle</p> <p>RED TROUBLE indicator is off and BLUE STATUS Indicator is on when you unplug from vehicle</p>	<p>Vehicle problem</p>	<p>Contact your vehicle service department.</p>
<p>RED TROUBLE indicator is on solid NOT connected to vehicle</p>	<p>Charger internal failure</p>	<p>Contact Customer Support for assistance.</p>
<p>RED TROUBLE indicator and BLUE STATUS indicator are both on</p>	<p>Charger trying to resolve internal error</p>	<p>Charger will return to normal operation within 1 minute. If problem persists, contact Customer Support for assistance.</p>

# APPENDIX

# SPECIFICATIONS

Model	Dual Voltage
Line input power:	120 VAC 240/208 VAC
Output power:	12 amps continuous @ 120 VAC 16 amps continuous @ 240/208 VAC
Circuit breaker rating:	15 amps @ 120 VAC 20 amps @ 240 VAC
Frequency:	60 Hz
Power draw at idle during charging:	< 2 watts < 4 watts
Cable length:	approximately 20 ft. (6.1 m)
Weight:	4 lb. (1.81 kg) - module 0.2 lb. (0.09kg) - adapter
Temperature – operating:	-40°C to +50°C (-40°F to 122°F)
Temperature – storing and transporting:	-40°C to +70°C (-40°F to +158°F)
Environmental rating:	NEMA 6P (watertight)
Vehicle – charger communication protocol:	SAE J1772 compliant
Charge coupler:	SAE J1772 compliant
Direction of charge:	Grid to vehicle

Specifications are subject to change without notice.

## INSTALLING THE WALLPLATE

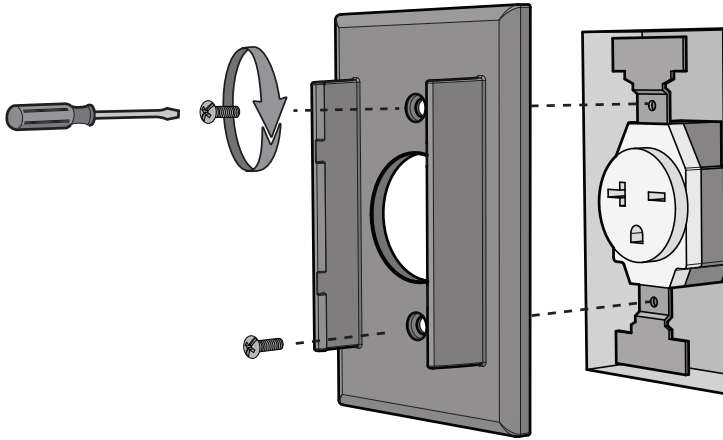

1. Choose a wall outlet that uses a single, round 5-15R or 6-20R receptacle. Remove the existing wall plate and screws.
2. Install optional retaining wall plate and secure using included screws.
3. Using a flat-head screwdriver, tighten the screws for the wall plate.

# HIGH VOLTAGE WARNING



High voltage is present in your electric meter housing and power distribution service panel. Contact with high voltage can cause death or serious personal injury.

.....

.....



DO NOT operate your charger with a damaged output cable, charge coupler, or module. Visually inspect the output cable, charge coupler, and charger module for damage before each use. If you detect any damage, stop using the charger and contact Customer Support.

.....

.....



ALWAYS position the charger output cable so that it will not be driven over, stepped on, tripped over, or otherwise damaged or stressed. To prevent personal injury and damage to the charger, ALWAYS stow the charger on hanger or in stowage bag after use.

.....

.....



Use the charger only to supply power to electric vehicles equipped with an SAE J1772 compliant vehicle receptacle. For more information, refer to the vehicle owner's manual.

.....

.....



Disconnect the charger from the wall outlet before cleaning it. To clean the charger, wipe it with a clean cloth dampened with water or a mild detergent solution suitable for use on automobile paint. Do not use chemicals or solvents. Do not submerge the charger.

# STATE OF CALIFORNIA PROPOSITION 65 WARNINGS

WARNING



This product contains a chemical known to the State of California to cause cancer or birth defects or other reproductive harm.

## FCC INFORMATION

This device complies with Part 15 of the FCC Rules. Operation is subject to the following two conditions:

- This device may not cause harmful interference.
- This device must accept any interference received, including interference that may cause undesired operation.

This product has been designed to protect against Radio Frequency Interference (RFI). However, there are some instances where high powered radio signals or nearby RF producing equipment (i.e. digital phones, RF communications equipment, etc.) could affect operation.

If you suspect your charger is receiving interference, take the following steps before contacting Customer Support for service:

1. Relocate nearby electrical appliances or equipment during charging.
2. Turn off nearby electrical appliances or equipment during charging.

**Important!** Changes or modifications to this product by anyone other than an authorized service provider will void FCC compliance.

## SAFETY FEATURES

The charger is designed with your safety as the highest priority and includes the following safety features to protect against the risk of electric shock:

- **Service Ground Check:** The charger constantly checks for the presence of a service ground connection. If the service ground ever fails, the charger RED TROUBLE Indicator turns ON and shuts down power to the vehicle.
- **Thermal Event Sensor:** Charger module senses out of ordinary thermal events and will shut the unit down.



- **GFCI Protection:** The charger is equipped with a Ground Fault Circuit Interruption (GFCI) reaction system to protect against electric shock. If the charger module detects an output ground fault, it will shut down power to the output cable and illuminate the RED TROUBLE Indicator.
- **Insulation:** The charger module, adapter, cable assembly and charge coupler are completely insulated (no exposed live parts) to protect against electric shock.
- **Unintentional Disconnection:** The charge coupler is designed to minimize unintentional disconnection. A pilot signal wire in the cable and charge coupler eliminates the possibility of electric shock when not connected to a vehicle or if an unintended disconnect occurs during a charge. Disconnection during charging is safe.

## LIMITED WARRANTY

### TURBOCORD CHARGER LIMITED WARRANTY

#### KEEP RECEIPT FOR WARRANTY CLAIMS.

The AeroVironment, Inc. (AV) TurboCord EV charger is warranted to be free of defects in material and workmanship for a period of thirty-six (36) months from the date of original purchase.

THIS IS THE SOLE AND EXCLUSIVE WARRANTY GIVEN BY AV WITH RESPECT TO THE TURBOCORD CHARGER. OTHER THAN EXPRESSED AND/OR IMPLIED WARRANTIES REQUIRED BY APPLICABLE LAWS OR WHICH ARE REQUIRED TO EXTEND FOR A LONGER PERIOD, THERE ARE NO WARRANTIES THAT EXTEND BEYOND THIS LIMITED WARRANTY AND ANY REQUIRED WARRANTIES ARE LIMITED IN DURATION TO THE WARRANTY PERIOD.

To the extent permitted by applicable laws: (a) AV's total warranty expense with respect to the charger is limited to a maximum of the original purchase price of the charger as applicable to a warranty claim; (b) AV's liability under this warranty shall be limited to the repair or replacement, at AV's option, of defective component parts; and (c) AV will not be liable for repair, replacement or service call costs for the charger not covered by this warranty, which shall be the responsibility of the purchaser.

This warranty shall be voided by damage or excessive wear to the charger caused by abnormal operating or environmental conditions (including exposure to acid, chemical fumes, metallic dust or extreme temperatures), accident, abuse, damage, misuse, vandalism, unauthorized alteration or repair, utility surges, or if the charger was not operated, serviced or maintained in strict compliance with the charger User's Manual and other printed instructions provided by AV and applicable building codes. Any evidence of an attempt to disassemble or reverse engineer the charger will void this warranty.

# INDEX

- A**  
auto-restart ..... 10
- B**  
BLUE STATUS Indicator ..... 8,  
9, 10, 12, 13
- C**  
charge coupler ..... 5, 10, 12,  
15, 17, 19  
charge module ..... 5  
circuit breaker ..... 15  
components ..... 5  
customer support ..... i
- D**  
dedicated circuit ..... 3  
document number ..... i
- E**  
electric shock ..... 3, 18, 19  
environmental rating ..... 15
- F**  
features ..... 3, 18
- G**  
GFCI ..... 10, 19
- H**  
hanger ..... 16, 17
- I**  
insulated ..... 19  
indicator light ..... 8, 9
- O**  
output ground ..... 19  
outlet ..... 3, 4, 6, 8, 10, 12,  
13, 17
- P**  
pilot signal wire ..... 19
- R**  
RED TROUBLE indicator ..... 8,  
10, 12, 13  
release button ..... 5, 9, 10
- S**  
SAE J1772 ..... 3, 15, 17  
safety features ..... 18  
serial number ..... i  
service ground ..... 18  
STATUS indicator ..... 3, 8,  
9, 10, 12, 13  
manual stop ..... 10
- T**  
temperature ..... 13, 15, 20  
TROUBLE indicator ..... 8, 10,  
12, 13, 18, 19
- W**  
wall receptacle ..... 6, 9  
warranty ..... 20  
weight ..... 15



**Customer Support**  
**1-888-235-4969**