



- High density delivery of power, data, and A/V.
- Stud or sheetrock mounting flexibility.
- Steel construction for residential MDU and commercial applications.
- Easily reconfigured to adapt to new applications.

FEATURES

- 2-Gang enclosure with 2 additional 3-Unit Hubbell iSTATION™ A/V Mounting locations.
- Stud or sheetrock mounting integrated into the enclosure. No need for extra hardware.
- ABS trim ring quickly cleans up sheetrock rough-in.
- Aesthetically pleasing and durable white powder coated steel base.
- Optional screw on cover reduces tampering and protects connections.

SPECIFICATIONS

- Mechanical
 - 18ga. cold rolled steel base
 - White powder coat finish
 - High impact ABS trim ring

STANDARDS/LISTINGS/VERIFICATIONS

- cULus 1863 listed
- UL V0 flame rating on ABS trim ring

netSELECT®
Infrastructure for Digital Lifestyles

Flat Panel Connection Enclosure

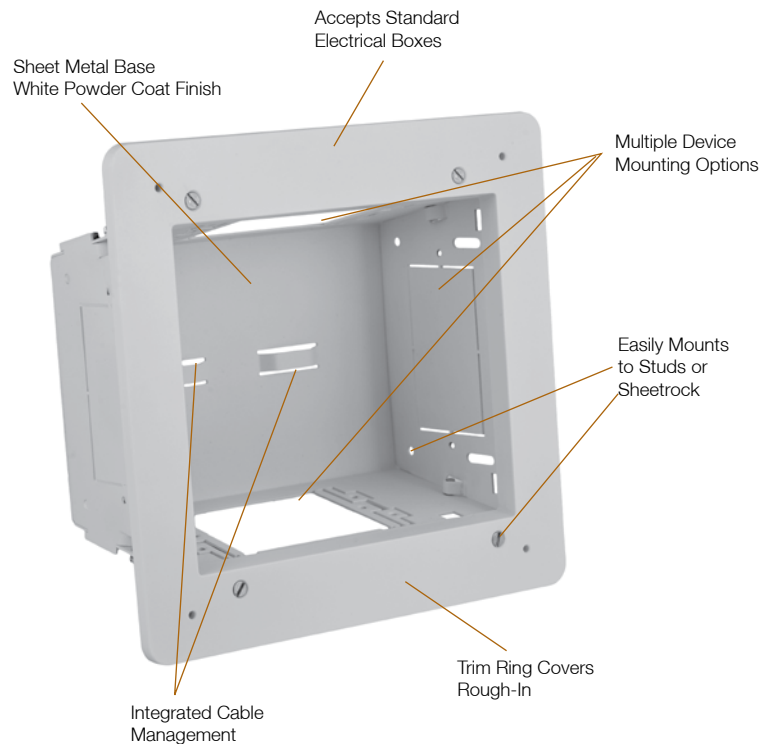

Hubbell’s netSELECT® FPTV connection enclosure delivers high-density connectivity and power in the wall. In-wall connections allow flat panel displays and interactive “smart” boards to sit flush without dangling cords. It quickly installs to studs or sheetrock without additional components or hardware.

The enclosure is designed to accommodate large bend radii associated with current cable types such as HDMI, DVI, RG6/UQ, and VGA. The base is constructed from 18ga. cold rolled steel, which provides toughness and meets requirements for high-rise residential and commercial construction. The white powder coat finish provides durability and an appearance that blends into the wall.

APPLICATIONS

- Interactive Whiteboards
- Flat Panel Displays
- Home Theater
- Information Displays
- Small Wireless APs
- Multimedia Workstations



ORDERING INFORMATION

FPTV Connection Enclosure

Description	Color	Catalog Number
2-Gang In-wall Enclosure	White	NSAV62M
Steel Cover for NSAV6 series	White	NSAV6C

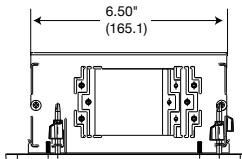

ACCESSORIES

Power Kits

Description	Color	Catalog Number
Standard Power Kit	White	NSOKP
Surge Protected Power Kit	Blue	NSOKPS

Unloaded Plates and Frames

Description	Color	Catalog Number
Hubbell iSTATION™ Adapter Frame	White	NSAVIMFW
1-G Blank Plate	White	SP14W
1-G Decorator Plate	White	NP26W
1-G iSTATION Plate	White	IMF1W
1-G 4-Port Keystone Plate	White	NSP14W

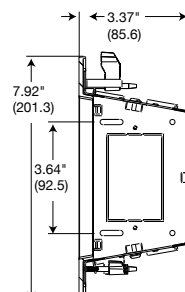
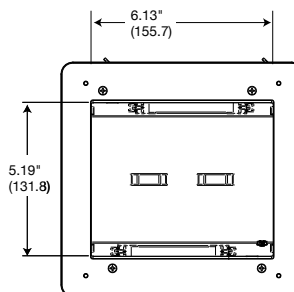

A/V Connectors and Plates

Description	Color	Catalog Number
1-Port HDMI Frame	White	NS801W
1-Port HDMI Frame	White	NS802W
HDMI Snap Fit	Black	SFHCBK
F-Connector Snap Fit	White	NSF70W
USB A-to-B Snap Fit	White	SFUSBABW
Cat 6 Snap Fit Jack	White	NSJ6W

INTEGRATED SOLUTIONS



Hubbell iSTATION™ & Cross Connect Solutions

- Front Loading Hubbell iSTATION™ Plates/Modules
- Style Line® Frames
- X-END™ A/V Cabling Solution
- Keystone Plates
- A/V Modules
- A/V Keystone Connectors
- Data Connections



MOUNTING OPTIONS

Mounts to Sheetrock

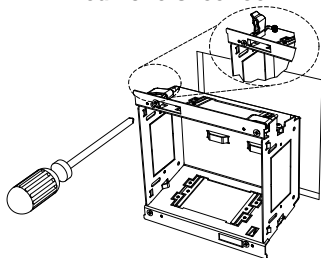

Mounts to Studs

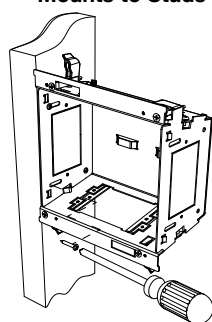

TYPICAL APPLICATION

INTERACTIVE WHITE BOARD EXAMPLE

Flat Panel/ "Smart" Board

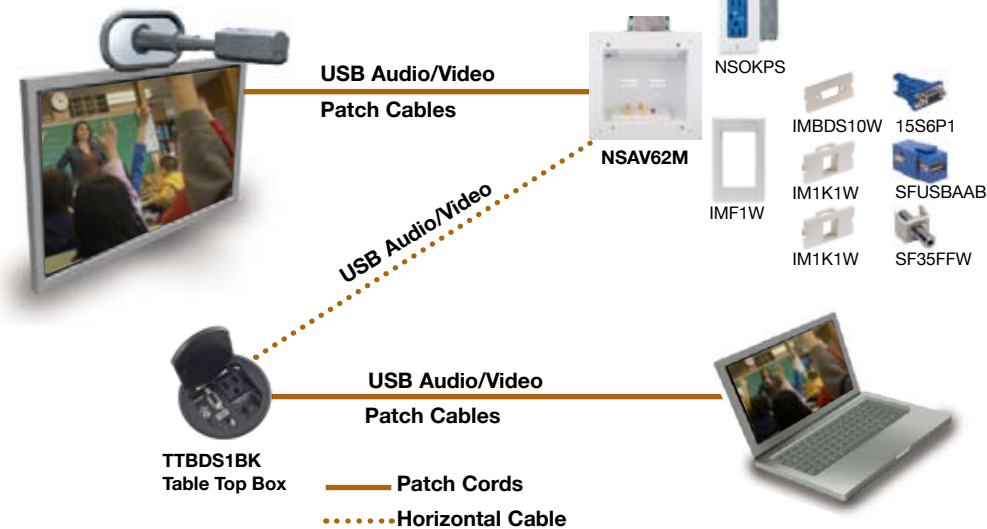

www.hubbell-wiring.com / www.hubbell-premise.com

