



Hubbell SystemOne 4-Inch Core, Three-Piece Units

Description	Catalog No. without Junction Box	Catalog No. with Junction Box*
4X4 Through Floor Fitting Through floor fitting with two 3/4 in. E.M.T. for communications and one 3/4 in. E.M.T. for power. For use with Hubbell SystemOne Universal Covers and S1SP4X4 and S1SPTL series sub-plates only. Universal cover and sub-plate ordered separately. 4-hour fire classification.	S1PT4X4FIT	S1PT4X4FITJ
Dual Channel Through Floor Fitting Through floor fitting with two 1 in. E.M.T. conduit stems to feed power and/or communication services. For use with Hubbell SystemOne universal covers and all Hubbell sub-plates except S1SP4X4 and S1SPTL series. Universal cover and sub-plate ordered separately. 4-hour fire classification.	S1PTFIT	S1PTFITJ
AV Through Floor Fitting Through floor fitting with one 3/4 in. E.M.T. conduit stem for power and one 1 1/2 in. E.M.T. conduit stem for communication services. Ideal for demanding, high capacity audio/video and data requirements. For use with Hubbell SystemOne universal covers and all Hubbell sub-plates except S1SP4X4 and S1SPTL series. Universal cover and sub-plate ordered separately. 4-hour fire classification.	S1PTAVFIT	S1PTAVFITJ



Note: *Junction box factory installed on through floor fitting.

Hubbell SystemOne Universal Covers



- Cast aluminum construction
- Durable powder coat finish

Description	Catalog No.
Carpet	S1CFCxx
Tile	S1TFCxx



xx = Color: **AL** (Aluminum Finish), **BRS** (Brass Finish), **BL** (Black), **GY** (Gray) and **I** (Ivory).

Poke Through Accessories

Description	Catalog No.
Abandonment Plates Used to cover abandoned SystemOne Fire-Rated Poke-Throughs or Floor Boxes.	 Black S1AP4BL Gray S1AP4GY
Fire-Rated Closure Plug Used to seal a 4-inch core hole when the FRPT is no longer required and the through-floor fitting is removed. Maintains the floor's 1-4 hour fire rating.	 Black S1FRP4BL Gray S1FRP4GY
Power Junction Box For use with SystemOne Fire-Rated Poke-Throughs. Provides 27.0 cubic inches. (1) 3/4 and (1) 1" E.M.T. connector supplied. Trade size knockouts:	 S1FRPTJB

- | | |
|--------|--------------|
| Top | (1) 1 inch |
| Bottom | (1) 3/4 inch |
| Sides | (2) 1/2 inch |
| | (1) 3/4 inch |



















Complies with UL514 A & C



HUBBELL DELIVERY

Hubbell SystemOne Sub-Plates

Description	Catalog No.	Description	Catalog No.	Description	Catalog No.
Style Line® Decorator/GFCI (2) Style Line® Decorator openings for power and/or datacom applications.	 S1SP	Duplex/Duplex (2) Duplex openings for power and/or datacom applications.	 S1SPDU	Duplex/Style Line® Decorator (1) Duplex and (1) Style Line® Decorator opening for power and/or datacom applications.	 S1SPDUSL
Hubbell 4 X 4 (4) 20A, 125V receptacles. (4) Keystone openings for Hubbell jacks or flush AV connectors. Power can be wired as single or two circuit with isolated ground capability.	 S1SP4X4	Carpet Furniture Feed Cover/Flange* (1) 3/4" and (1) 1 1/2" N.P.T. access holes for power and/or datacom applications. Universal cover not required. Includes carpet flange.	 S1SPFFAL	Tile Furniture Feed Cover/Flange* (1) 3/4" and (1) 1 1/2" N.P.T. access holes for power and/or datacom applications. Universal cover not required. Includes tile flange.	 S1SPFFTAL
Provided with 15 ft. wire leads	S1SP4X415	Aluminum Fin.	S1SPFFBRS	Aluminum Fin.	S1SPFFTAL
Provided with 30 ft. wire leads	S1SP4X430	Brass Fin.	S1SPFFBLS	Brass Fin.	S1SPFFTBS
		Black	S1SPFFBL	Black	S1SPFFTBL
		Gray	S1SPFFGY	Gray	S1SPFTGY
Single Receptacle + Data Opening for 20 or 30A Twist-Lock® receptacle (1.56" OD) and (2) Keystone openings for Hubbell jacks or flush AV connectors.	 S1SPTL	Hubbell DataCom + Power (1) 20A, 125V receptacle and 3-unit recessed Hubbell iSTATION opening for data, voice, and AV applications.	 S1SP3IM	Hubbell DataCom + Duplex (1) Duplex opening, (2) flush Keystone openings and 1.5 unit recessed Hubbell iSTATION opening for data, voice and AV applications.	 S1SPDU2IM
Hubbell DataCom + Style Line® Decorator (1) Style Line® Decorator opening, (2) flush Keystone openings and 1.5 unit recessed Hubbell iSTATION opening for data, voice and AV applications.	 S1SPSL2IM	Hubbell DataCom 1 unit flush Hubbell iSTATION opening and 3-unit recessed Hubbell iSTATION opening for data, voice, and AV applications.	 S1SP4IM	Active Multimedia + Power Single 20A, 125V receptacle; (2) flush Keystone openings; (1) rectangular Style Line® Decorator opening to accommodate active multimedia modules or low voltage outlet frames.	 S1SPAMM20
Extron® or FSR + Power (1) 20A, 125V receptacle. Recessed opening for (3) single Extron® MAAP series adapter plates or FSR IPS plates.	 S1SPEXT1	Extron® or FSR + Power (1) 20A, 125V receptacle. Recessed opening for (1) single Extron® MAAP and (2) single AAP series adapter plates or FSR IPS plates.	 S1SPEXT2	Extron® or FSR Single-Service Recessed opening for (2) single Extron® MAAP and (2) single AAP series adapter plates or FSR IPS plates.	 S1SPEXT3
Extron® AAP + Power (1) 20A, 125V receptacle. (2) flush Keystone and recessed opening for (2) single Extron® AAP Series adapter plates.	 S1SPEXT4				

Note: *Furnished with two screw-in flexible metal conduit connectors. See Section C for complete offering of Hubbell jacks and frames.
† See page Q23 for FRPT Configuration Chart.

Sub-Plate Accessories

Description	Description	Catalog No.
Replacement Threaded Conduit Plugs Used with S1SPFFxx and S1SPFFTxx ONLY. Sub-plate is supplied with plugs.	Black Style Line® decorator blank frame.	 S1200BK
 1 1/2" Plug	 3/4" Plug	
Catalog No.	S1FP15xx	S1FP34xx

xx = Color: **AL** (Aluminum Finish), **BRS** (Brass Finish), **BK** (Black), and **GY** (Gray). See page V30 for color chart.

Extron® is a registered trademark of Extron Electronics.

ScrubShield®
Complies with UL514 A & C



Technical Information
Hubbell SystemOne High-Capacity A/V FRPT
S1PT3IM Series and S1PTAVFIT

ScrubShield™
 Complies with UL514A

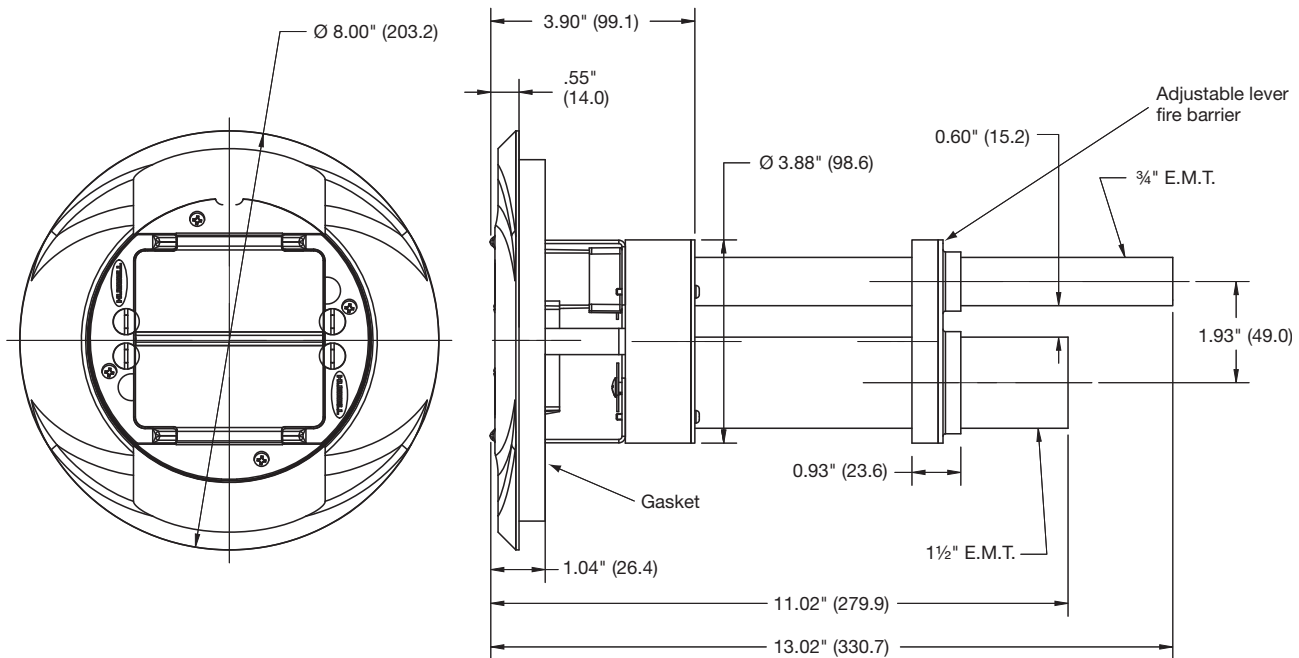

Product Information

- Powder coat cast aluminum cover and flange (color finish options: aluminum, brass, black, gray and ivory).
- S1PT3IM Series subplate supplied with pre-wired single 20A 125V black receptacle, NEMA 5-20R.
- Wired with three #12 AWG THHN stranded copper conductors.
- S1PT3IM subplate also accepts three unit recessed iSTATION; 15-Pin VGA, RCA, S-Video, 3.5 mm stereo and XLR microphone jacks.

Application Data

- Mounted in 4 in. (76.2) cored concrete diameter through hole.
- Floor thickness range: 2¼ in. to 7 in. (57.2 to 177.8).
- UL Listed for fire resistance in 1 – 4 hour rated floors.
- Approved for use in the City of Chicago.

UL Listed Wiring Capacity

Voice/Data conduit up to ninety-six (96) #22 AWG telephone/data conductors.

When conductors larger than 22 AWG are used, the total cross-sectional area of the copper conductors shall not exceed the total cross-sectional area of the 22 AWG conductors permitted in the low voltage compartment.

Note: When connection conduit sweeps to through-floor fittings, ensure compliance with NEC fill tables.

UL Characteristics

Listing	UL File Number
Outlet Box	E31999
Fire Resistance	R8429

For use in 1, 1½, 2, 3 or 4 hour rated unprotected reinforced floors or in 1, 2, or 3 hour rated floors employing steel floor units and concrete topping (D900 Series designs).

UL Spacing Restrictions - Minimum of 2 ft. on center and not more than one unit per each 65 square feet of floor area in each span.

Note: The above product data pertains to both one-piece and three-piece units.

