

Apprx. 495 square feet

Apartments: 16,24

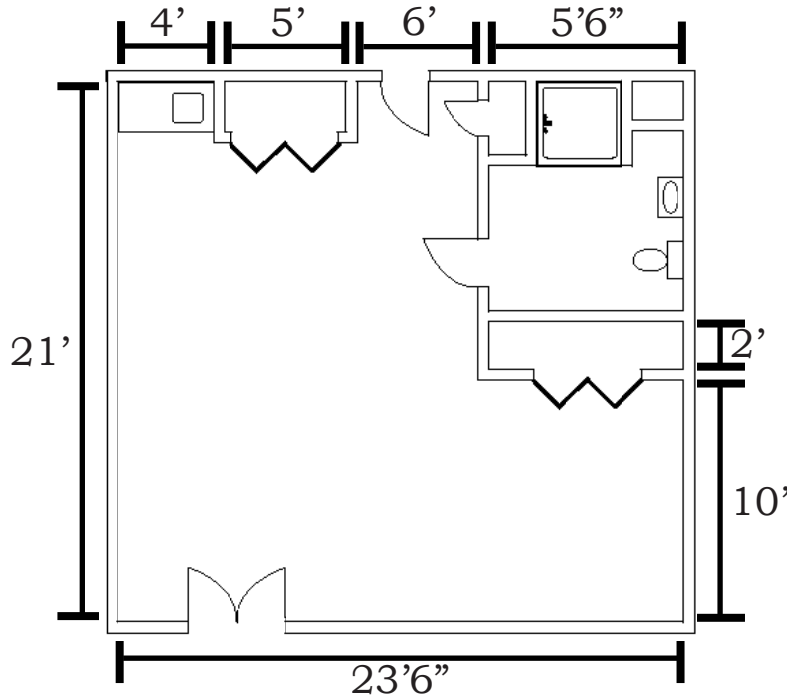

SERVICES INCLUDE:

- 24-hour assistance
- *CareSteps* personal care plan
 - Ongoing Checks
 - Scheduled & unscheduled nurse practitioner
 - Scheduled podiatrist visits
 - Medication purchasing & assistance
 - Quarterly & as-needed care evaluations
 - Home health nursing & therapies & Hospice
- Three home-style meals daily
- Planned off & on-site recreation
- Scheduled transportation
- Weekly housekeeping & daily tidy ups
- Weekly personal laundry

APARTMENT FEATURES:

- Emergency alert system
- Individually controlled heat & AC
- Large picture windows
- Private bath with shower with safety bars and seat
- All utilities included
- Special soundproofing between apartments
- Cable TV, internet, and phone ready

Community Fee: _____

Rent: _____

***CareSteps*:** _____

Phone: _____

Date: _____ **Total:** _____

Developed For: _____



Apprx. 428 square feet

Apartment: 20

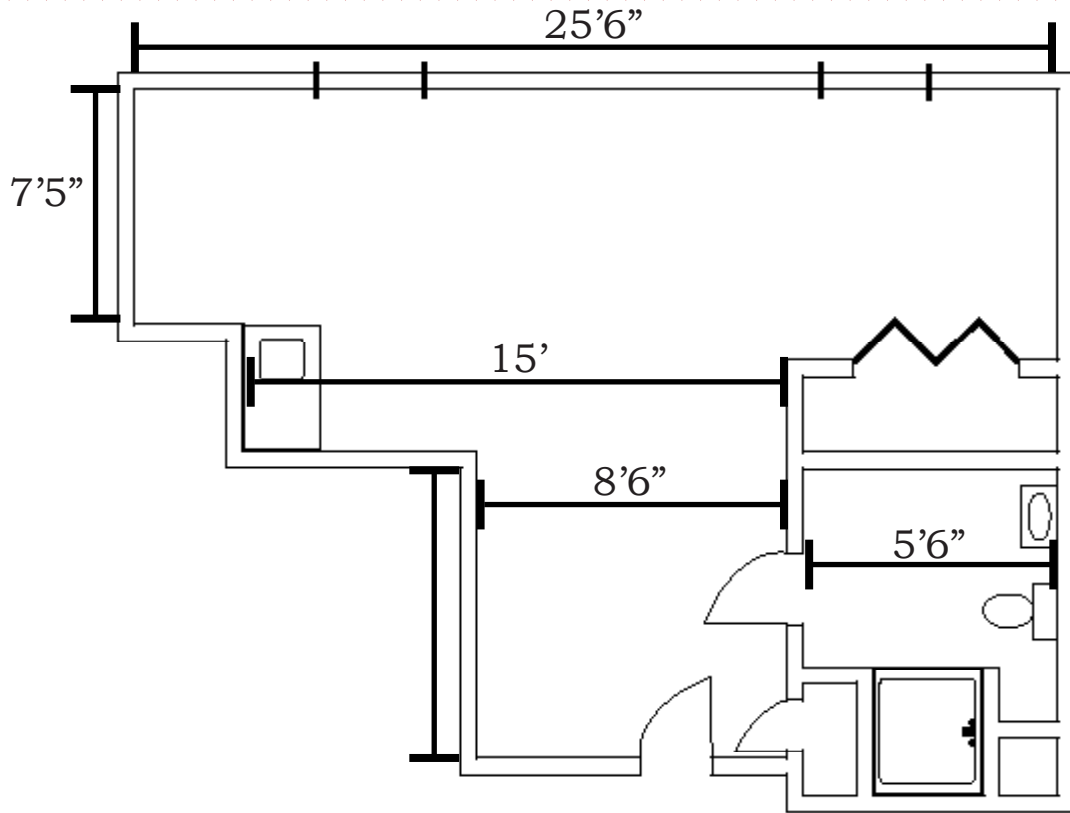

SERVICES INCLUDE:

- 24-hour assistance
- *CareSteps* personal care plan
 - Ongoing Checks
 - Scheduled & unscheduled nurse practitioner
 - Scheduled podiatrist visits
 - Medication purchasing & assistance
 - Quarterly & as-needed care evaluations
 - Home health nursing & therapies & Hospice
- Three home-style meals daily
- Planned off & on-site recreation
- Scheduled transportation
- Weekly housekeeping & daily tidy ups
- Weekly personal laundry

APARTMENT FEATURES:

- Emergency alert system
- Individually controlled heat & AC
- Large picture windows
- Private bath with shower with safety bars and seat
- All utilities included
- Special soundproofing between apartments
- Cable TV, internet, and phone ready

Community Fee: _____

Rent: _____

CareSteps: _____

Phone: _____

Date: _____ **Total:** _____

Developed For: _____



Apprx. 456 square feet

Apartment: 45

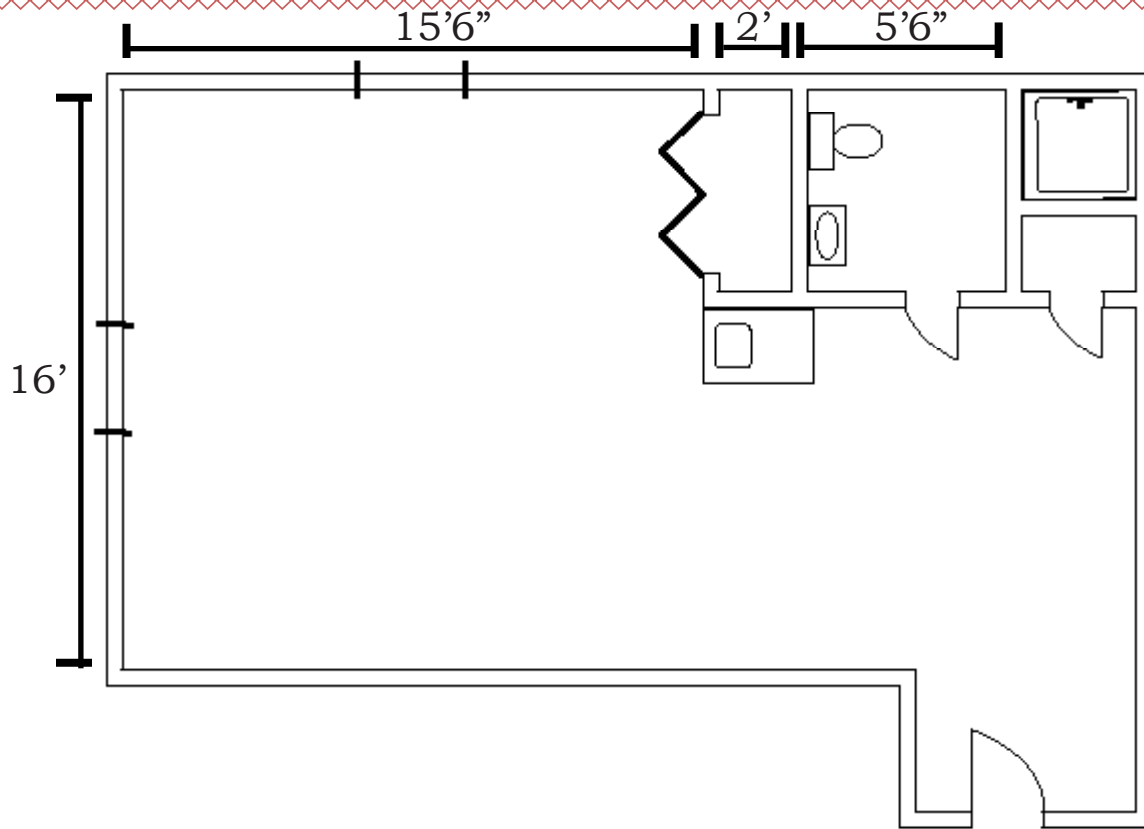

SERVICES INCLUDE:

- 24-hour assistance
- *CareSteps* personal care plan
 - Ongoing Checks
 - Scheduled & unscheduled nurse practitioner
 - Scheduled podiatrist visits
 - Medication purchasing & assistance
 - Quarterly & as-needed care evaluations
 - Home health nursing & therapies & Hospice
- Three home-style meals daily
- Planned off & on-site recreation
- Scheduled transportation
- Weekly housekeeping & daily tidy ups
- Weekly personal laundry

APARTMENT FEATURES:

- Emergency alert system
- Individually controlled heat & AC
- Large picture windows
- Private bath with shower with safety bars and seat
- All utilities included
- Special soundproofing between apartments
- Cable TV, internet, and phone ready

Community Fee: _____

Rent: _____

CareSteps: _____

Phone: _____

Date: _____ **Total:** _____

Developed For: _____



Apprx. 344 square feet

Apartments: 6,9,32,35

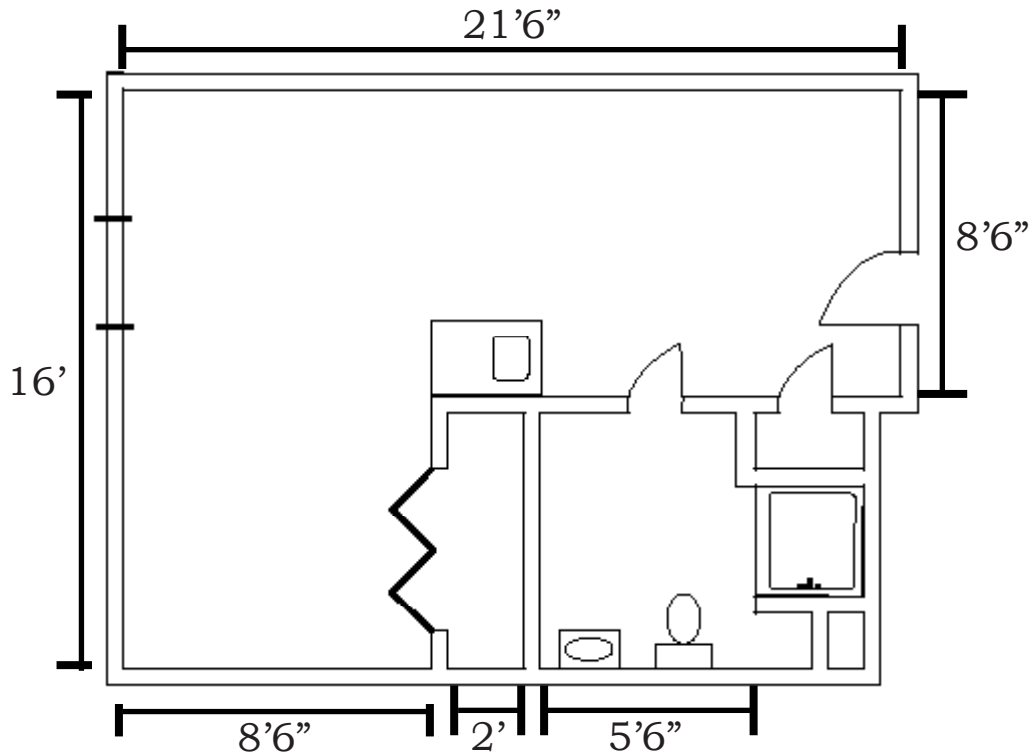

SERVICES INCLUDE:

- 24-hour assistance
- *CareSteps* personal care plan
 - Ongoing Checks
 - Scheduled & unscheduled nurse practitioner
 - Scheduled podiatrist visits
 - Medication purchasing & assistance
 - Quarterly & as-needed care evaluations
 - Home health nursing & therapies & Hospice
- Three home-style meals daily
- Planned off & on-site recreation
- Scheduled transportation
- Weekly housekeeping & daily tidy ups
- Weekly personal laundry

APARTMENT FEATURES:

- Emergency alert system
- Individually controlled heat & AC
- Large picture windows
- Private bath with shower with safety bars and seat
- All utilities included
- Special soundproofing between apartments
- Cable TV, internet, and phone ready

Community Fee: _____

Rent: _____

***CareSteps*:** _____

Phone: _____

Date: _____ **Total:** _____

Developed For: _____



Apprx. 345 square feet

Apartments: 15,25

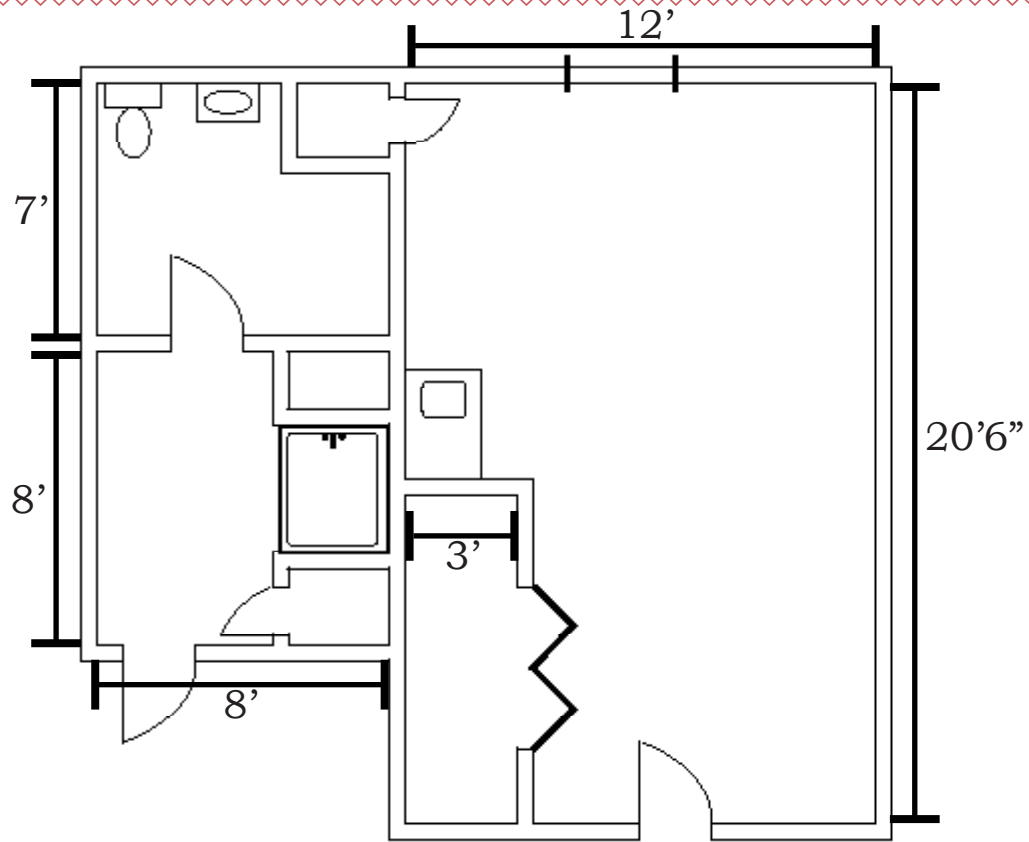

SERVICES INCLUDE:

- 24-hour assistance
- *CareSteps* personal care plan
 - Ongoing Checks
 - Scheduled & unscheduled nurse practitioner
 - Scheduled podiatrist visits
 - Medication purchasing & assistance
 - Quarterly & as-needed care evaluations
 - Home health nursing & therapies & Hospice
- Three home-style meals daily
- Planned off & on-site recreation
- Scheduled transportation
- Weekly housekeeping & daily tidy ups
- Weekly personal laundry

APARTMENT FEATURES:

- Emergency alert system
- Individually controlled heat & AC
- Large picture windows
- Private bath with shower with safety bars and seat
- All utilities included
- Special soundproofing between apartments
- Cable TV, internet, and phone ready

Community Fee: _____

Rent: _____

***CareSteps*:** _____

Phone: _____

Date: _____ **Total:** _____

Developed For: _____



Apprx. 341 square feet

Apartments: 3,38

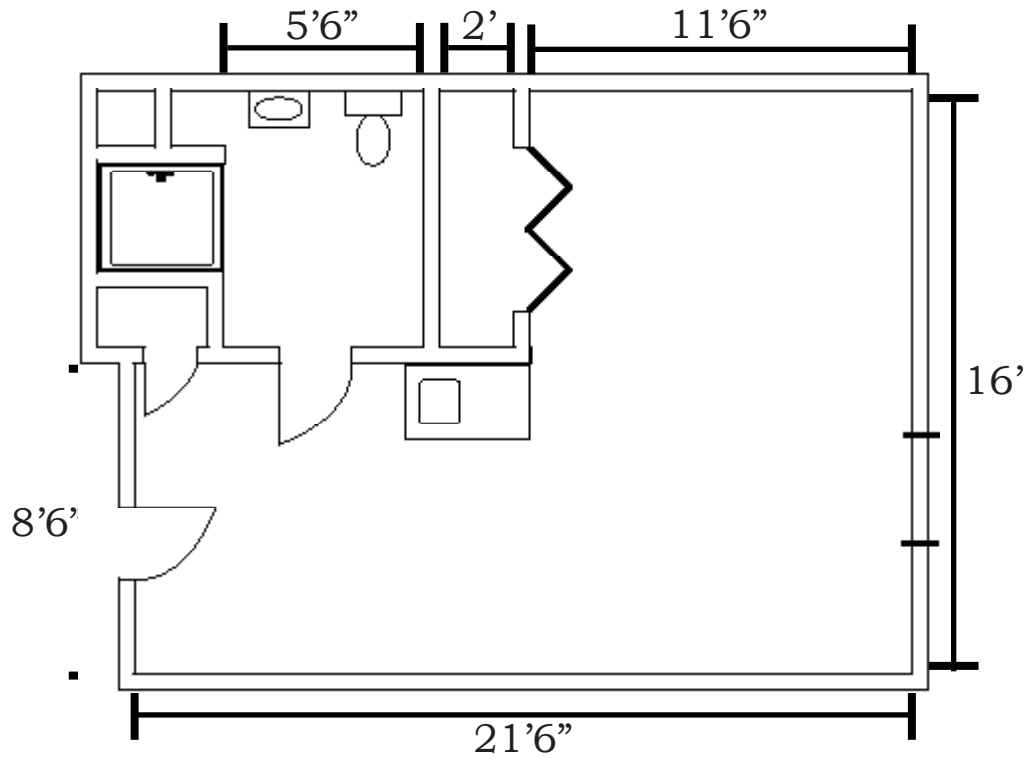

SERVICES INCLUDE:

- 24-hour assistance
- *CareSteps* personal care plan
 - Ongoing Checks
 - Scheduled & unscheduled nurse practitioner
 - Scheduled podiatrist visits
 - Medication purchasing & assistance
 - Quarterly & as-needed care evaluations
 - Home health nursing & therapies & Hospice
- Three home-style meals daily
- Planned off & on-site recreation
- Scheduled transportation
- Weekly housekeeping & daily tidy ups
- Weekly personal laundry

APARTMENT FEATURES:

- Emergency alert system
- Individually controlled heat & AC
- Large picture windows
- Private bath with shower with safety bars and seat
- All utilities included
- Special soundproofing between apartments
- Cable TV, internet, and phone ready

Community Fee: _____

Rent: _____

CareSteps: _____

Phone: _____

Date: _____ **Total:** _____

Developed For: _____



Apprx. 341 square feet

Apartments: 1,39

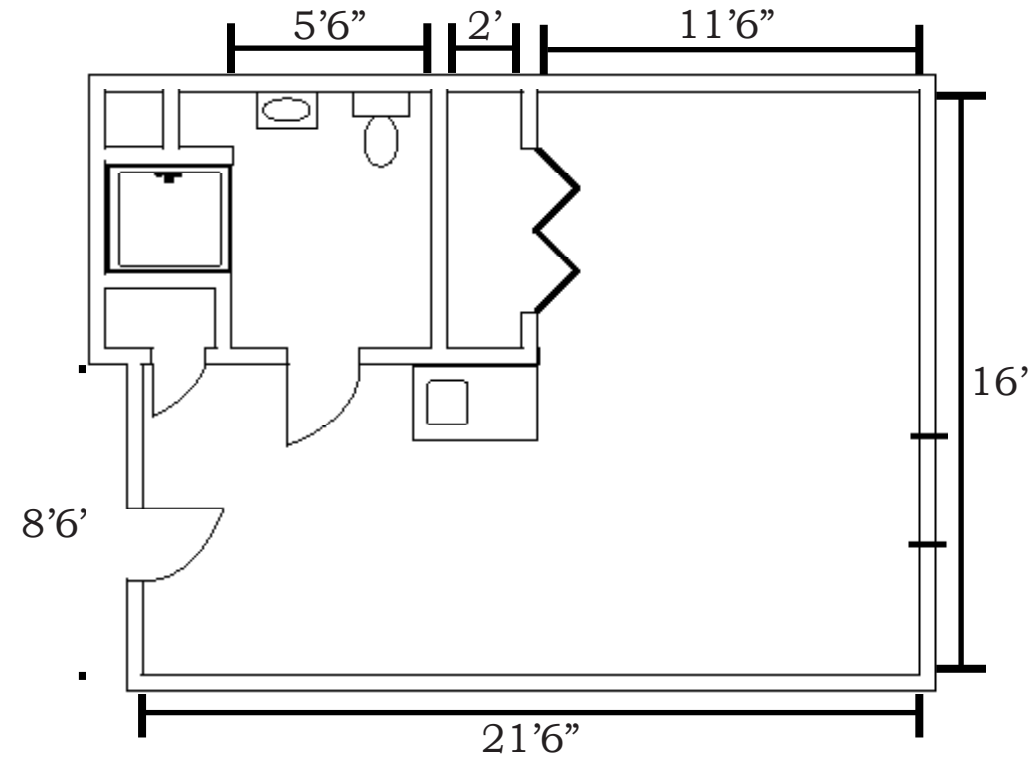

SERVICES INCLUDE:

- 24-hour assistance
- *CareSteps* personal care plan
 - Ongoing Checks
 - Scheduled & unscheduled nurse practitioner
 - Scheduled podiatrist visits
 - Medication purchasing & assistance
 - Quarterly & as-needed care evaluations
 - Home health nursing & therapies & Hospice
- Three home-style meals daily
- Planned off & on-site recreation
- Scheduled transportation
- Weekly housekeeping & daily tidy ups
- Weekly personal laundry

APARTMENT FEATURES:

- Emergency alert system
- Individually controlled heat & AC
- Large picture windows
- Private bath with shower with safety bars and seat
- All utilities included
- Special soundproofing between apartments
- Cable TV, internet, and phone ready

Community Fee: _____

Rent: _____

***CareSteps*:** _____

Phone: _____

Date: _____ **Total:** _____

Developed For: _____



Apprx. 321 square feet

Apartments: 2,40

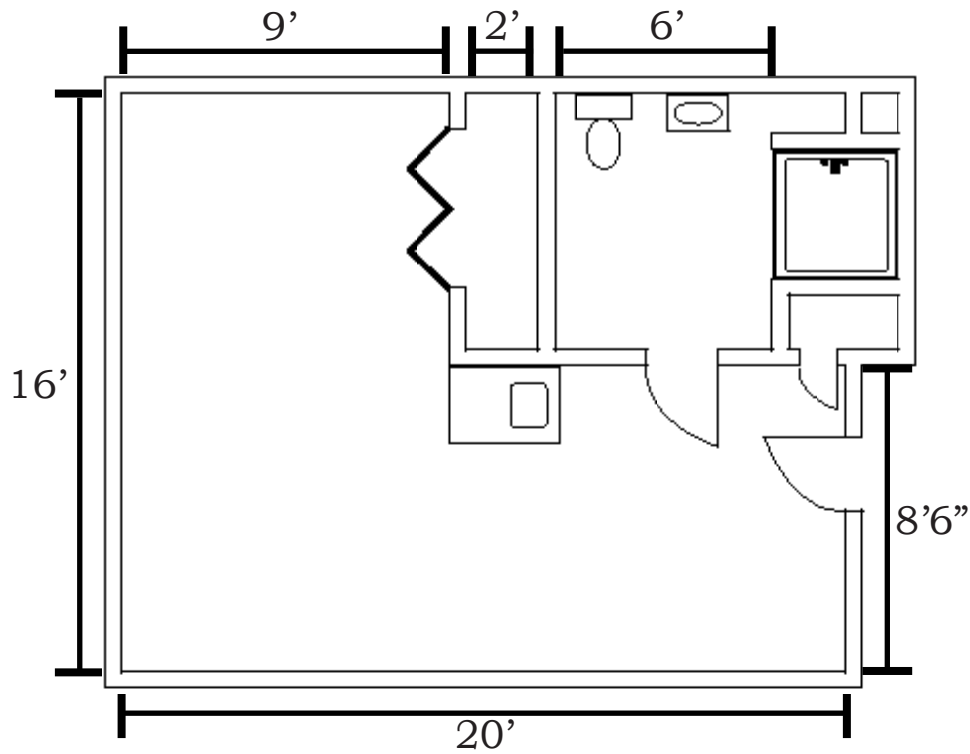

SERVICES INCLUDE:

- 24-hour assistance
- *CareSteps* personal care plan
 - Ongoing Checks
 - Scheduled & unscheduled nurse practitioner
 - Scheduled podiatrist visits
 - Medication purchasing & assistance
 - Quarterly & as-needed care evaluations
 - Home health nursing & therapies & Hospice
- Three home-style meals daily
- Planned off & on-site recreation
- Scheduled transportation
- Weekly housekeeping & daily tidy ups
- Weekly personal laundry

APARTMENT FEATURES:

- Emergency alert system
- Individually controlled heat & AC
- Large picture windows
- Private bath with shower with safety bars and seat
- All utilities included
- Special soundproofing between apartments
- Cable TV, internet, and phone ready

Community Fee: _____

Rent: _____

CareSteps: _____

Phone: _____

Date: _____ **Total:** _____

Developed For: _____



Apprx. 337 square feet

Apartments: 18,26

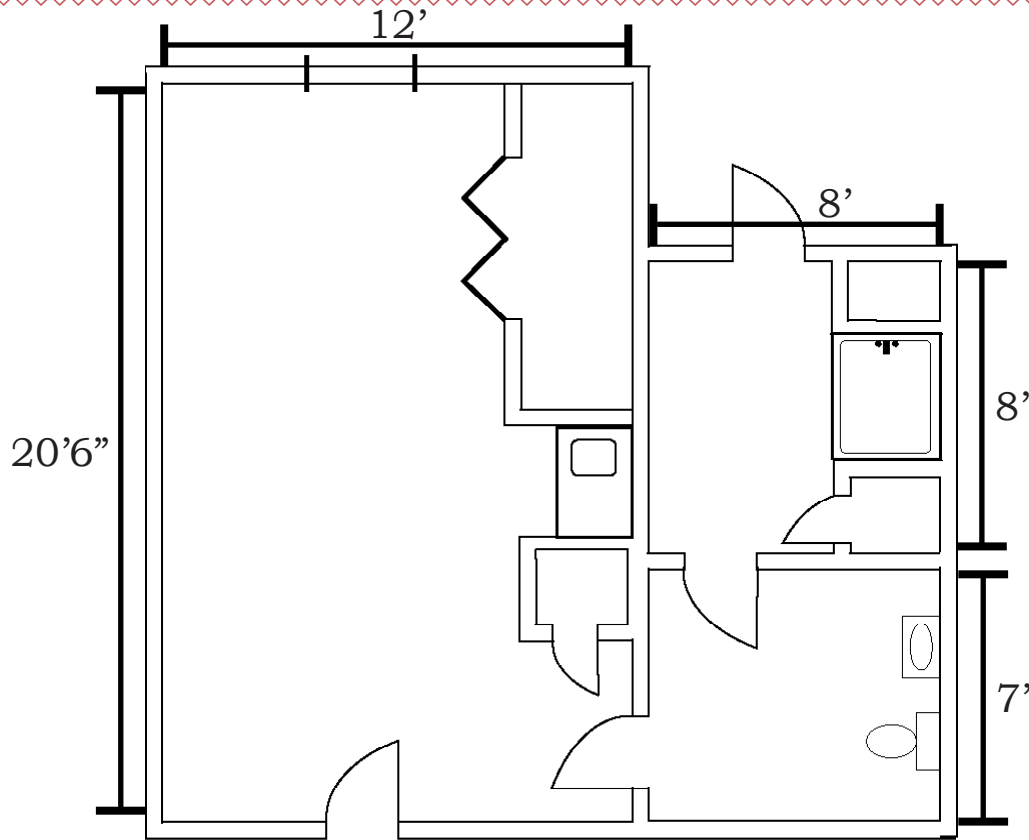

SERVICES INCLUDE:

- 24-hour assistance
- *CareSteps* personal care plan
 - Ongoing Checks
 - Scheduled & unscheduled nurse practitioner
 - Scheduled podiatrist visits
 - Medication purchasing & assistance
 - Quarterly & as-needed care evaluations
 - Home health nursing & therapies & Hospice
- Three home-style meals daily
- Planned off & on-site recreation
- Scheduled transportation
- Weekly housekeeping & daily tidy ups
- Weekly personal laundry

APARTMENT FEATURES:

- Emergency alert system
- Individually controlled heat & AC
- Large picture windows
- Private bath with shower with safety bars and seat
- All utilities included
- Special soundproofing between apartments
- Cable TV, internet, and phone ready

Community Fee: _____

Rent: _____

CareSteps: _____

Phone: _____

Date: _____ **Total:** _____

Developed For: _____



Apprx. 321 square feet

Apartments: 8, 10, 11, 12, 13*, 27, 28, 29, 30, 31, 33

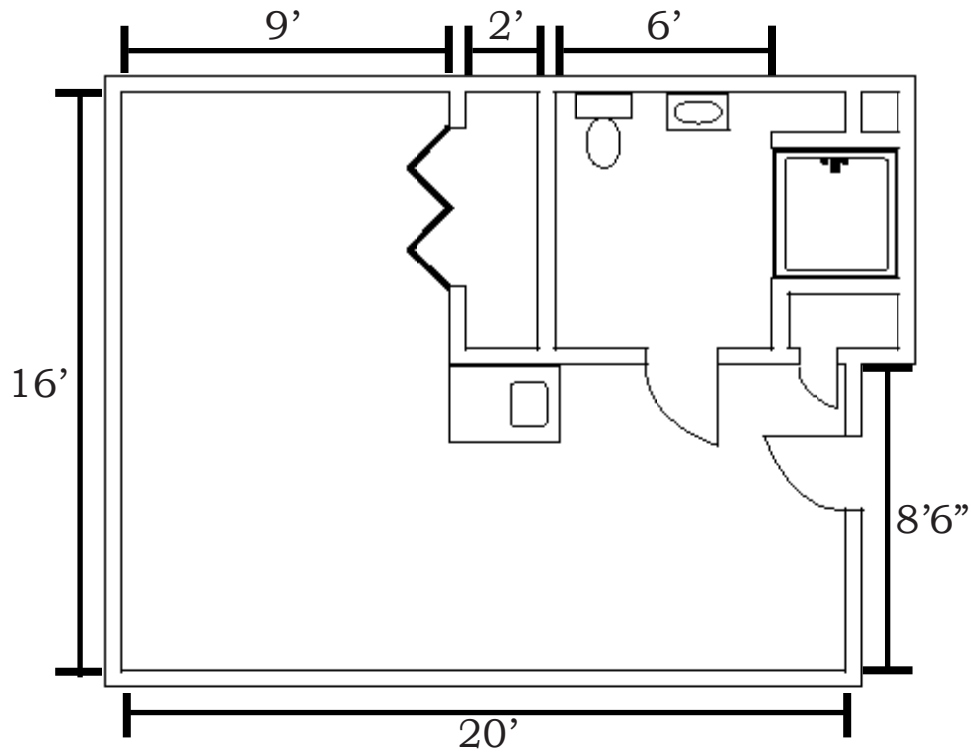

* Hearing impaired

SERVICES INCLUDE:

- 24-hour assistance
- *CareSteps* personal care plan
 - Ongoing Checks
 - Scheduled & unscheduled nurse practitioner
 - Scheduled podiatrist visits
 - Medication purchasing & assistance
 - Quarterly & as-needed care evaluations
 - Home health nursing & therapies & Hospice
- Three home-style meals daily
- Planned off & on-site recreation
- Scheduled transportation
- Weekly housekeeping & daily tidy ups
- Weekly personal laundry

APARTMENT FEATURES:

- Emergency alert system
- Individually controlled heat & AC
- Large picture windows
- Private bath with shower with safety bars and seat
- All utilities included
- Special soundproofing between apartments
- Cable TV, internet, and phone ready

Community Fee: _____

Rent: _____

***CareSteps*:** _____

Phone: _____

Date: _____ **Total:** _____

Developed For: _____



Apprx. 321 square feet

Apartments: 14

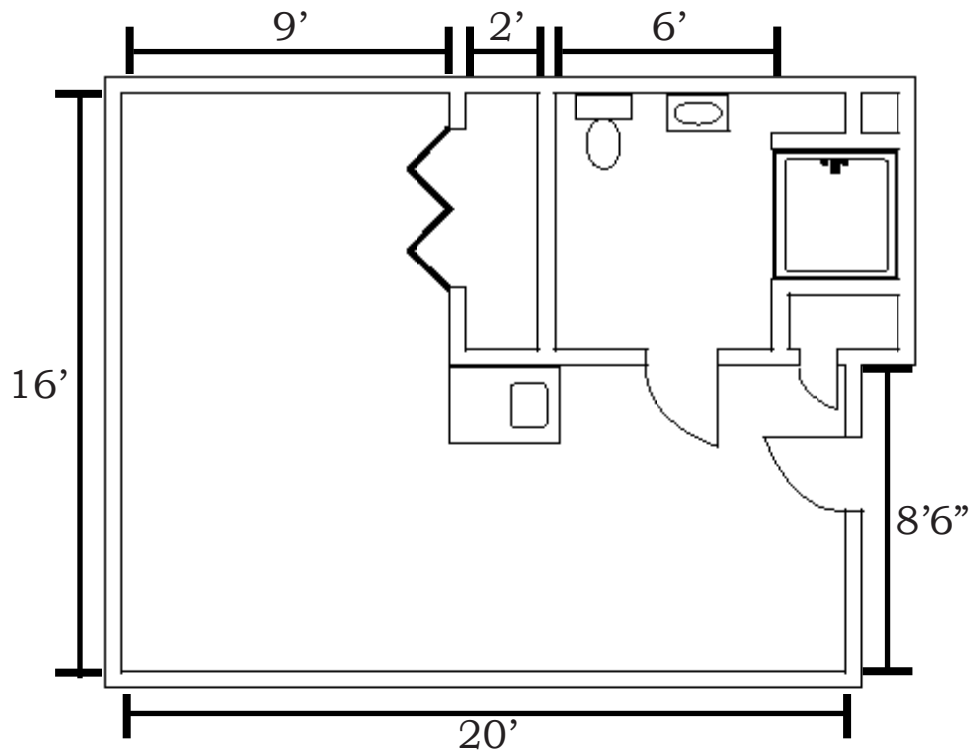

SERVICES INCLUDE:

- 24-hour assistance
- *CareSteps* personal care plan
 - Ongoing Checks
 - Scheduled & unscheduled nurse practitioner
 - Scheduled podiatrist visits
 - Medication purchasing & assistance
 - Quarterly & as-needed care evaluations
 - Home health nursing & therapies & Hospice
- Three home-style meals daily
- Planned off & on-site recreation
- Scheduled transportation
- Weekly housekeeping & daily tidy ups
- Weekly personal laundry

APARTMENT FEATURES:

- Emergency alert system
- Individually controlled heat & AC
- Large picture windows
- Private bath with shower with safety bars and seat
- All utilities included
- Special soundproofing between apartments
- Cable TV, internet, and phone ready

Community Fee: _____

Rent: _____

CareSteps: _____

Phone: _____

Date: _____ **Total:** _____

Developed For: _____



Apprx. 321 square feet

Apartments 5, 17, 23, 36

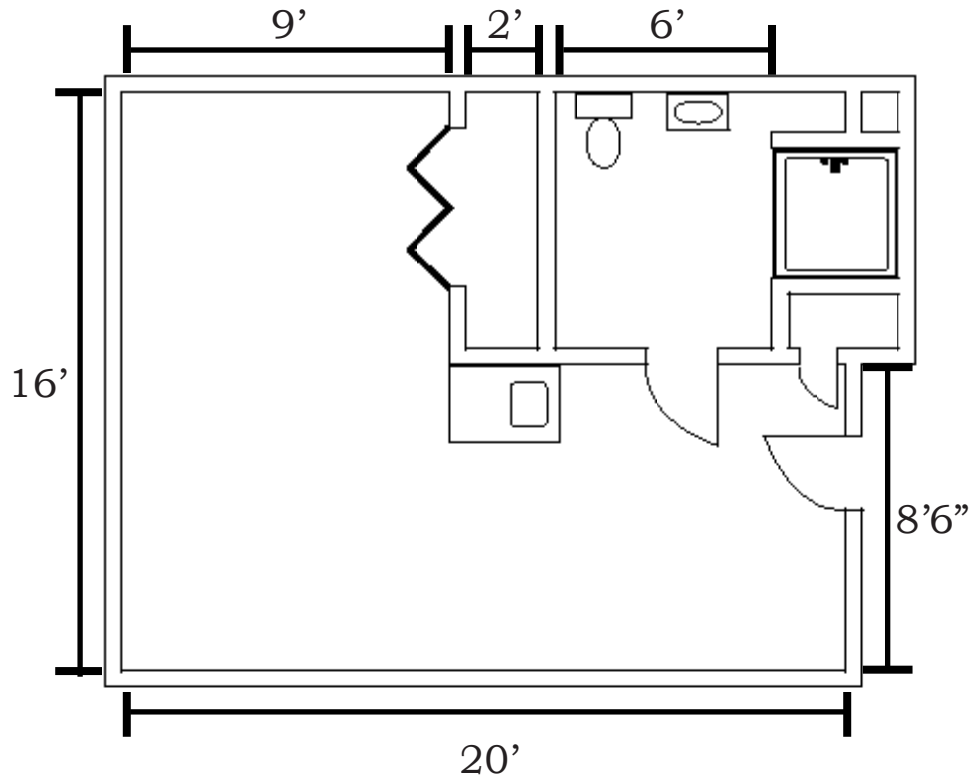

SERVICES INCLUDE:

- 24-hour assistance
- *CareSteps* personal care plan
 - Ongoing Checks
 - Scheduled & unscheduled nurse practitioner
 - Scheduled podiatrist visits
 - Medication purchasing & assistance
 - Quarterly & as-needed care evaluations
 - Home health nursing & therapies & Hospice
- Three home-style meals daily
- Planned off & on-site recreation
- Scheduled transportation
- Weekly housekeeping & daily tidy ups
- Weekly personal laundry

APARTMENT FEATURES:

- Emergency alert system
- Individually controlled heat & AC
- Large picture windows
- Private bath with shower with safety bars and seat
- All utilities included
- Special soundproofing between apartments
- Cable TV, internet, and phone ready

Community Fee: _____

Rent: _____

CareSteps: _____

Phone: _____

Date: _____ **Total:** _____

Developed For: _____



Apprx. 321 square feet

Apartments: 4,7,19,21,22,34,37

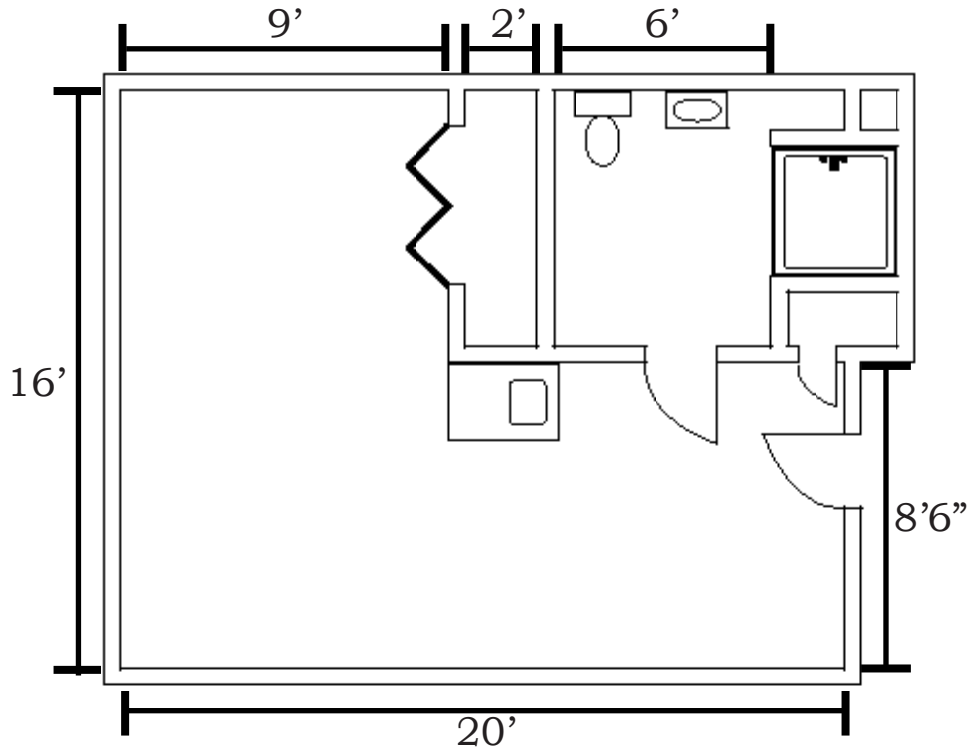

SERVICES INCLUDE:

- 24-hour assistance
- *CareSteps* personal care plan
 - Ongoing Checks
 - Scheduled & unscheduled nurse practitioner
 - Scheduled podiatrist visits
 - Medication purchasing & assistance
 - Quarterly & as-needed care evaluations
 - Home health nursing & therapies & Hospice
- Three home-style meals daily
- Planned off & on-site recreation
- Scheduled transportation
- Weekly housekeeping & daily tidy ups
- Weekly personal laundry

APARTMENT FEATURES:

- Emergency alert system
- Individually controlled heat & AC
- Large picture windows
- Private bath with shower with safety bars and seat
- All utilities included
- Special soundproofing between apartments
- Cable TV, internet, and phone ready

Community Fee: _____

Rent: _____

CareSteps: _____

Phone: _____

Date: _____ **Total:** _____

Developed For: _____



Apprx. 321 square feet

Apartments: 41, 42, 43, 44, 46, 47

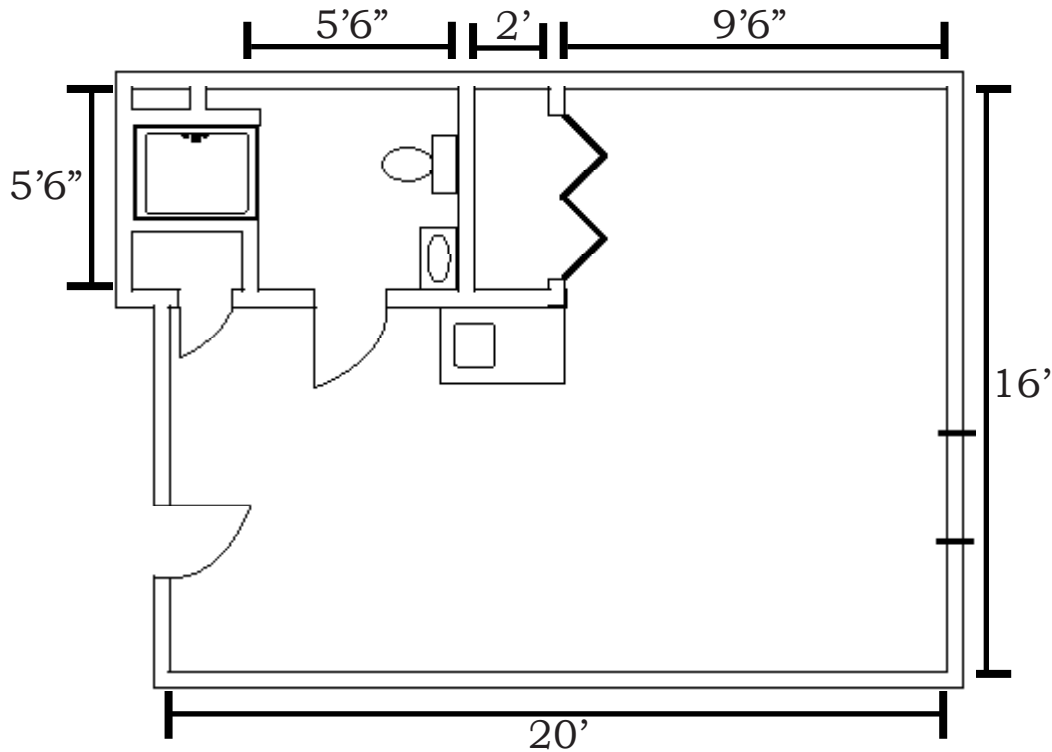

SERVICES INCLUDE:

- 24-hour assistance
- *CareSteps* personal care plan
 - Ongoing Checks
 - Scheduled & unscheduled nurse practitioner
 - Scheduled podiatrist visits
 - Medication purchasing & assistance
 - Quarterly & as-needed care evaluations
 - Home health nursing & therapies & Hospice
- Three home-style meals daily
- Planned off & on-site recreation
- Scheduled transportation
- Weekly housekeeping & daily tidy ups
- Weekly personal laundry

APARTMENT FEATURES:

- Emergency alert system
- Individually controlled heat & AC
- Large picture windows
- Private bath with shower with safety bars and seat
- All utilities included
- Special soundproofing between apartments
- Cable TV, internet, and phone ready

Community Fee: _____

Rent: _____

***CareSteps*:** _____

Phone: _____

Date: _____ **Total:** _____

Developed For: _____

