

PSW654-8K WINCH

PIERCE

PULLING FOR YOU



CATEGORY	WINCH
PART NO.	PSW654-8K

PRODUCT DESCRIPTION
9,000 lb Worm Gear Electric DC Winch / 8" drum

SPECIFICATIONS	
RATED LINE PULL	9,000 lb
LINE SPEED	14 fpm
VOLTAGE	12V
RATIO	470:1
AMPERE	60/400 amps
MINIMUM WIRE GAUGE	4 gauge
RECOMMENDED BATTERY	650 CCA
MOTOR	1.5 hp
WINCH CONSTRUCTION	Cast Metal
GEAR TRAIN	Worm Gear
CLUTCH	Dog
BRAKE	Worm Gear
ROTATION OF WINCH	CCW
DRUM SIZE	3.5" x 8"
WIRE ROPE RECOMMENDED	3/8" x 100'
WINCH WEIGHT	88 lb
GROSS WEIGHT	92 lb
WINCH DIMENSIONS (LxWxH)	16.25" x 8" x 13.5"
BOX DIMENSIONS (LxWxH)	14" x 14" x 24"

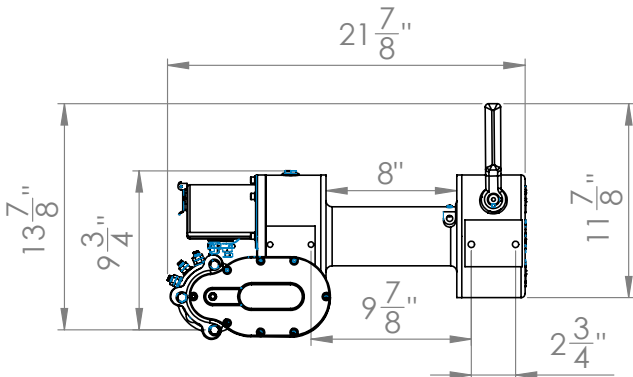
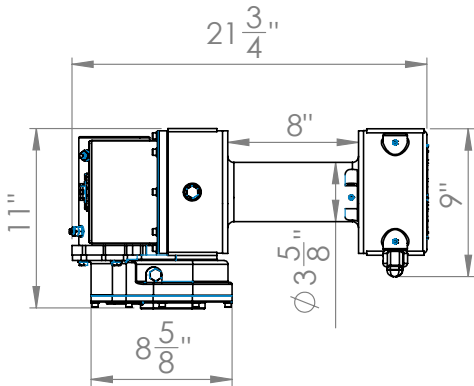
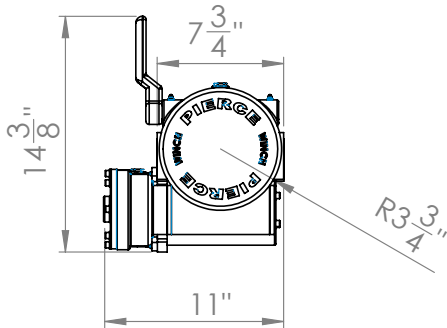

LINE SPEEDS			
LAYERS OF WIRE ROPE	PULL	DRUM CAPACITY	SPEED (@ 16 GPM)
1	9,000 lb	25 ft	12.6 fpm
2	7,500 lb	50 ft	15.1 fpm
3	6,400 lb	75 ft	17.5 fpm
4	5,600 lb	100 ft	20.0 fpm