

PANEL CUTOUT

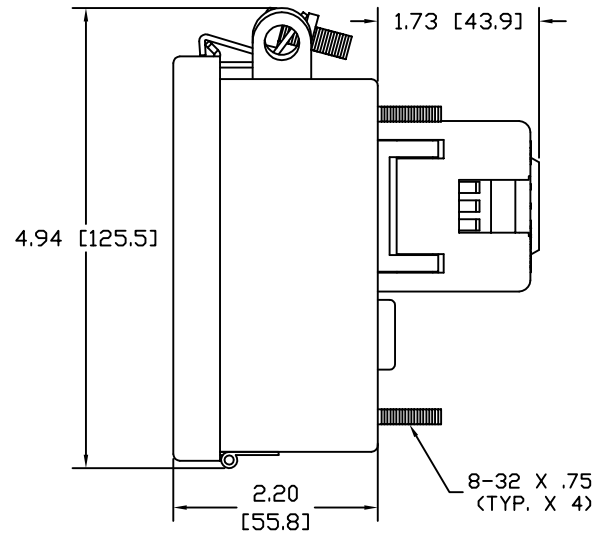
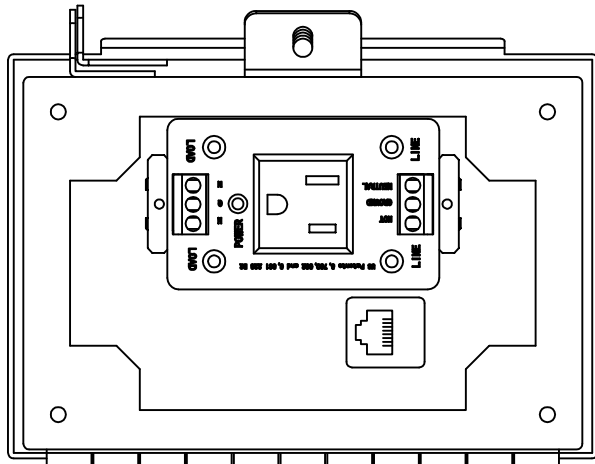
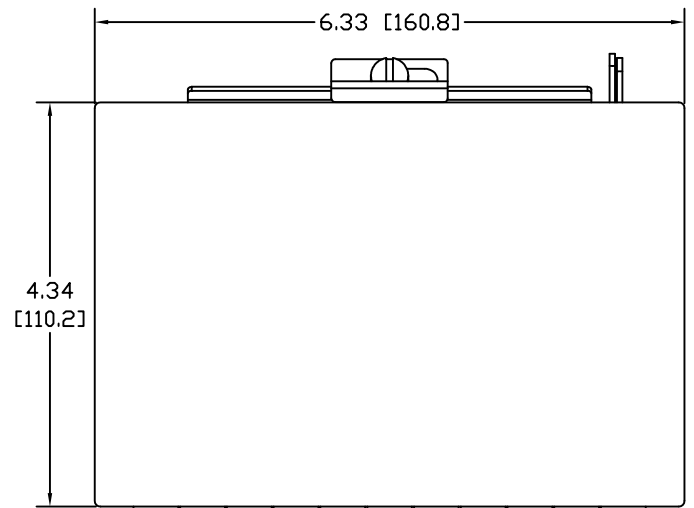
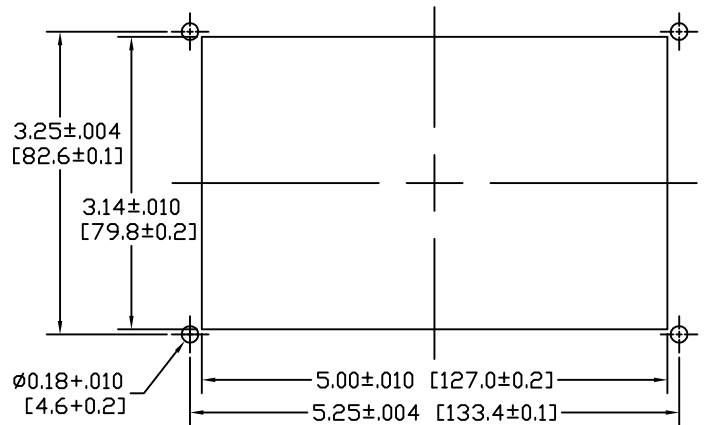

- NOTE:
- 1.) HOUSING INSERTS COMPONENT LOCATIONS ARE APPROXIMATE.
 - 2.) HOUSINGS ARE UL RECOGNIZED TYPE 4X OTHER ENVIRONMENTAL RATINGS MAY APPLY.
 - 3.) FINAL ASSEMBLIES: UL RECOGNIZED, CSA, AND CE MAY APPLY CONSULT FACTORY.
 - 4.) HOUSING: 16 GA. 316 STAINLESS STEEL HOUSING

GracePort(R) is a Registered Trademark of Grace Engineered Products, Inc.
Property of Grace Engineered Products, Inc.