

Power Defense molded case circuit breakers

Product guide



A globally rated platform from Eaton

Power Defense™ molded case circuit breakers (MCCBs) are globally certified to meet your local requirements, empowering you to build and design systems that can be used anywhere in the world. Wherever Eaton does business, Power Defense MCCBs are there, backed by Eaton's global support and fulfillment network, with the right resources in place to minimize your project lead-time and maximize your uptime. Integrating new products can be a challenge, which is why the Power Defense MCCBs are available with online instructions, support and a product selector. These unique tools can help you engineer and deliver your projects quickly, ultimately helping to improve your bottom line.

The Power Defense MCCBs feature the Power Xpert® Release (PXR) electronic trip units, offering premium protection and communication features allowing you to use fewer components and a simplified design while keeping your system connected, your equipment and employees protected, and your customers informed. The PXR trip unit family has models that will cover all of your needs, including fully programmable models that enable ultimate customization and flexibility, as well as value models that offer all of the benefits of electronic trip units, with simple setup and coordination.

PXR electronic trip units are equipped with the latest micro-processor technology including industry-first advanced algorithms that notify you when your power distribution system needs to be maintained or replaced. They also have the embedded ability to accurately measure energy consumption with no additional meters or equipment, delivering critical data about your power distribution system and energy use in your facility.

Whether you're building production capacity or a legacy, the green factory of the future or the newest high rise on the next horizon, Power Defense MCCBs will serve as guardian and protector as your ideas are realized in concrete and steel.

Power Defense molded case circuit breakers, a globally rated platform from Eaton

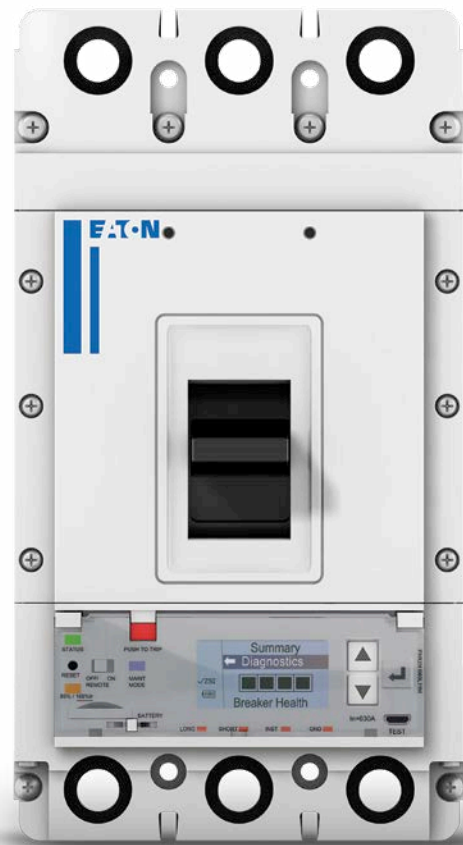

Power Defense molded case circuit breaker portfolio

Frame PD-1

3.00 W x 5.50 H x 2.99 D inches
(76.2 x 139.7 x 76.0 mm)



Current range
15–125 A

Maximum NEMA voltage
347 Y/600 Vac/ 250 Vdc

Maximum IEC voltage
415 Vac/250 Vdc

Certifications
UL/CSA/CE/CCC

Interrupting capacity at 480 Vac (kAIC)
18, 25, 35, 50, 65, 85, 100

100% UL rated options
Current limiting options

Trip unit options
T/M fixed fixed

- Through-cover accessories

Frame PD-2

4.13 W x 6.00 H x 3.38 D inches
(105.0 x 152.4 x 86.0 mm)



Current range
15–225 A

Maximum NEMA voltage
600 Vac/250 Vdc

Maximum IEC voltage
690 Vac/250 Vdc

Certifications
UL/CSA/CE/CCC

Interrupting capacity at 480 Vac (kAIC)
25, 35, 50, 65, 85, 100

100% UL rated options
Current limiting options

Trip unit options
T/M fixed fixed
PXR 10
PXR 20
PXR 20D
PXR 25

Electronic protection
LSI, LSIG

- Through-cover accessories
- Available with 2 PXR communication relays
- 1 Relay with modbus RTU

Frame PD-3

5.48 W x 10.13 H x 4.09 D inches
(139.2 x 257.3 x 104.0 mm)



Current range
45–600 A

Maximum NEMA voltage
600 Vac/250 Vdc

Maximum IEC voltage
690 Vac/250 Vdc

Certifications
UL/CSA/CE/CCC

Interrupting capacity at 480 Vac (kAIC)
25, 35, 50, 65, 85, 100

100% UL rated options
Current limiting options

Trip unit options
T/M fixed adjustable
PXR 10
PXR 20
PXR 20D
PXR 25

Electronic protection
LSI, LSIG, ALSI, ALSIG

- Through-cover accessories
- Available with 2 PXR communication relays
- Field-interchangeable trip units

Frame PD-4

8.25 W x 16.00 H x 4.06 D inches
(209.6 x 406.4 x 103.1 mm)



Current range
300–800 A

Maximum NEMA voltage
600 Vac/250 Vdc

Maximum IEC voltage
690 Vac/250 Vdc

Certifications
UL/CSA/CE/CCC

Interrupting capacity at 480 Vac (kAIC)
35, 50, 65

100% UL rated options

Trip unit options
T/M fixed adjustable
PXR 10
PXR 20
PXR 20D
PXR 25

Electronic protection
LSI, LSIG, ALSI, ALSIG

- Through-cover accessories
- Available with 2 PXR communication relays
- Field-interchangeable trip units

Frame PD-5

8.25 W x 16.00 H x 5.50 D inches
(209.6 x 406.4 x 139.7 mm)



Current range
320–1200 A

Maximum NEMA voltage
600 Vac/250 Vdc

Maximum IEC voltage
690 Vac/250 Vdc

Certifications
UL/CSA/CE/CCC

Interrupting capacity at 480 Vac (kAIC)
50, 65, 85, 100, 150

100% UL rated options

Trip unit options
PXR 20
PXR 20D
PXR 25

Electronic protection
LSI, LSIG, ALSI, ALSIG

- Field-interchangeable accessories
- Available with 3 PXR communication relays
- Field-interchangeable trip units

Frame PD-6

15.50 W x 16.00 H x 9.00 D inches
(393.7 x 406.4 x 228.6 mm)



Current range
700–2500 A

Maximum NEMA voltage
600 Vac/250 Vdc

Maximum IEC voltage
690 Vac/250 Vdc

Certifications
UL/CSA/CE/CCC

Interrupting capacity at 480 Vac (kAIC)
65, 85, 100

100% UL rated options

Trip unit options
PXR 20
PXR 20D
PXR 25

Electronic protection
LSI, LSIG, ALSI, ALSIG

- Field-interchangeable accessories
- Available with 3 PXR communication relays
- Field-interchangeable trip units

Advanced technology and features

Breaker health

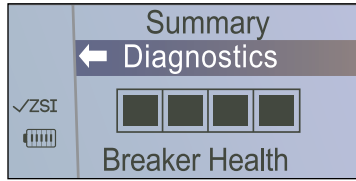

- Industry-first algorithm that provides real-time evaluation of breaker condition by tracking and analyzing diagnostic details including breaker operations, short-circuit fault levels, operational time, internal temperature and overloads
- Monitors and communicates breaker health status, enabling predictive maintenance to avoid costly, unscheduled downtime

Zone selective interlocking (ZSI)



- Designed to reduce thermal and mechanical stress on distribution equipment and arc flash incident energy released during phase or ground faults by enabling upstream breakers to override customer-defined delay settings while communicating with downstream breakers
- PXR trip unit displays ZSI signal indication when system is engaged and communicating, allowing network integrity testing and providing operational status

Arcflash Reduction Maintenance System™ (ARMS)



- Industry-leading solution to reduce arc flash energy released during maintenance operations using a separate analog circuit to provide faster than instantaneous clearing times
- Flexibility to enable system and provide visual indication by communications, remote switch and relay, or directly on the trip unit face
- Adjustable ARMS settings via LCD screen or PXP software

Enhanced ground fault protection

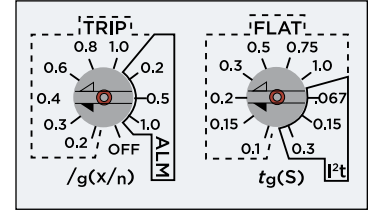

- Expanded ground fault setting options improve coordination capabilities
- Combined functionality to trip and/or alarm, including a pre-alarm option via a programmable relay, provides maximum protection options and system uptime
- An OFF setting also provides flexibility in testing, troubleshooting and inventory management

Versatile communications options



- Imbedded Modbus RTU
- Additional communications protocols, including Modbus TCP, webpage interface and PROFIBUS, available via CAM Link to Eaton's Communications Adapter Modules (CAM)
- CAM module relays that can be programmed for custom breaker and trip unit visibility

Cause of trip LEDs

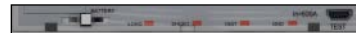

- Cause of trip indication provides insights into a trip event, increasing worker safety and efficiency while troubleshooting
- PXR 20, 20D and 25 include LEDs on the face of the trip unit that will pulse ON/OFF until the unit is reset. An easily replaceable backup battery is included in the trip unit, but only used when no auxiliary power is connected
- All PXR store additional trip event details in their memory that can be easily accessed via the USB port by the PXP software

Programmable relays

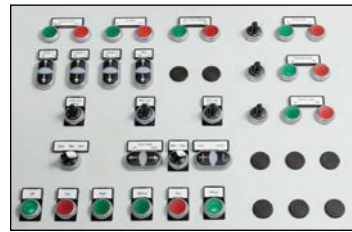

- Multiple programmable relays provide user customizable visibility into breaker and trip unit, such as status, trip events, alarms, indication of ZSI or ARMS and breaker health

Power Xpert Protection Manager (PXP) software



- PXR trip units equipped with micro-USB connection for secondary injection testing through your PC, saving you labor hours and the cost of expensive test kits
- Configure trip unit settings with direct-to-trip unit or offline setup, including duplication of settings between units
- Capture waveforms, monitor real-time power and energy readings, store up to 200 events, create printable test reports and customize display orientation

Metering capability

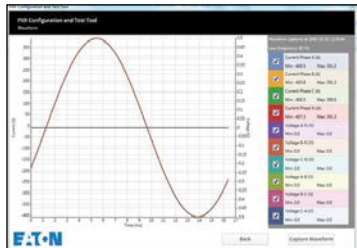

- Current and voltage metering accurate to 0.5% of reading; power and energy metering accurate to 1% of reading
- Voltage metering internal to trip unit with no need for external modules

LCD display with programmable settings



- Local availability to fully programmable settings, breaker diagnostics, visual customization, event records, injection testing and unit information.

Power Xpert Release (PXR) electronic trip units

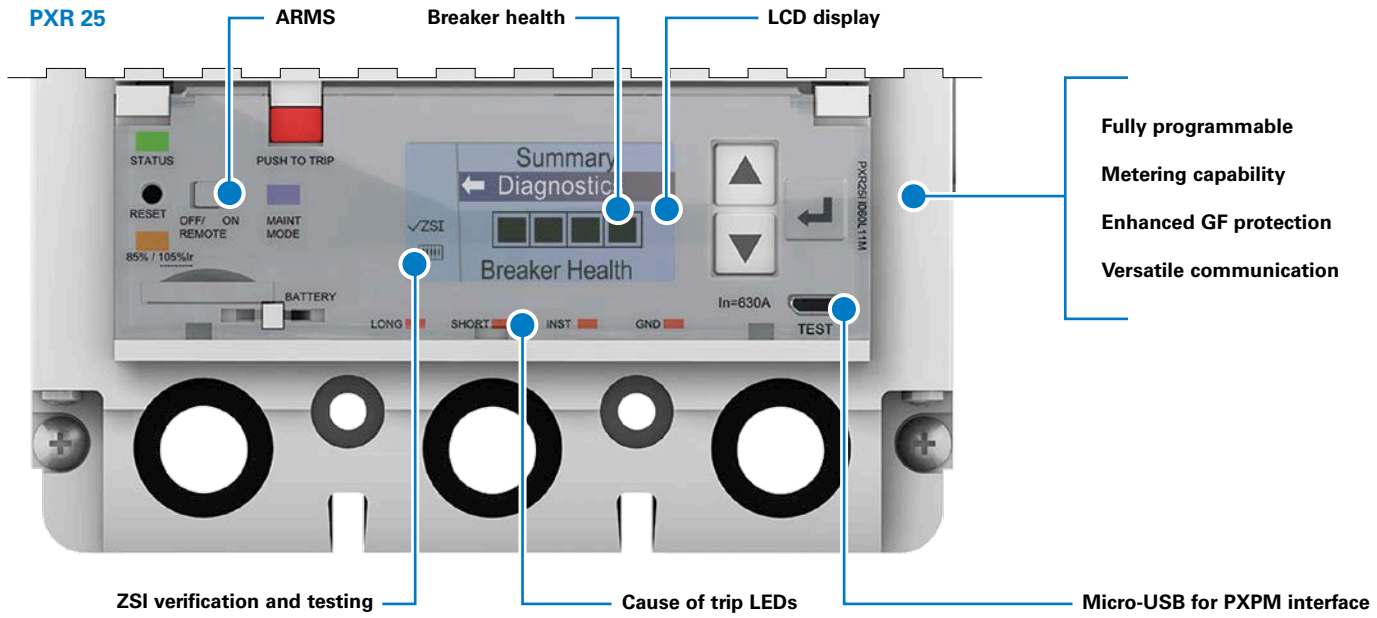

Power Xpert Release (PXR) features

Features	PXR 10	PXR 20	PXR 20D	PXR 25
Protection types	LSI	LSI/LSIG	LSI/LSIG	LSI/LSIG
Status indication	●	●	●	●
USB secondary injection testing	●	●	●	●
Programmable by USB port (PXPM)	●	●	●	●
Independent instantaneous adjustment	●	●	●	●
Adjustable L, S, I, G pickup and time		●	●	●
Cause of trip indication	▲	●	●	●
Load alarm indication with 2 levels		●	●	●
Programmable load alarm levels			●	●
Ground fault protection and alarm		○	○	○
Arcflash Reduction Maintenance System (ARMS) Available PD3, PD4, PD5, PD6		○	○	○
Zone selective interlocking (ZSI) with indication		○	○	○
Programmable relays		○	●	●
Modbus RTU communication		○	●	●
CAM module communication		○	○	○
Rotatable LCD display			●	●
Breaker health and diagnostic monitoring		▲	●	●
Voltage metering accurate to 0.5%				●
Power and energy metering accurate to 1%				●

● Standard

○ Optional

▲ Available through USB port (PXPM)

Accessories

The Power Defense molded case circuit breakers feature a wide range of accessories to fit your application, including new, through-cover accessories designed for easy installation, fast uptime and simplified stocking.

For full details on accessory voltages, sizes and configurations, and additional accessories not shown, please see our new reference catalog at Eaton.com/powerdefense.

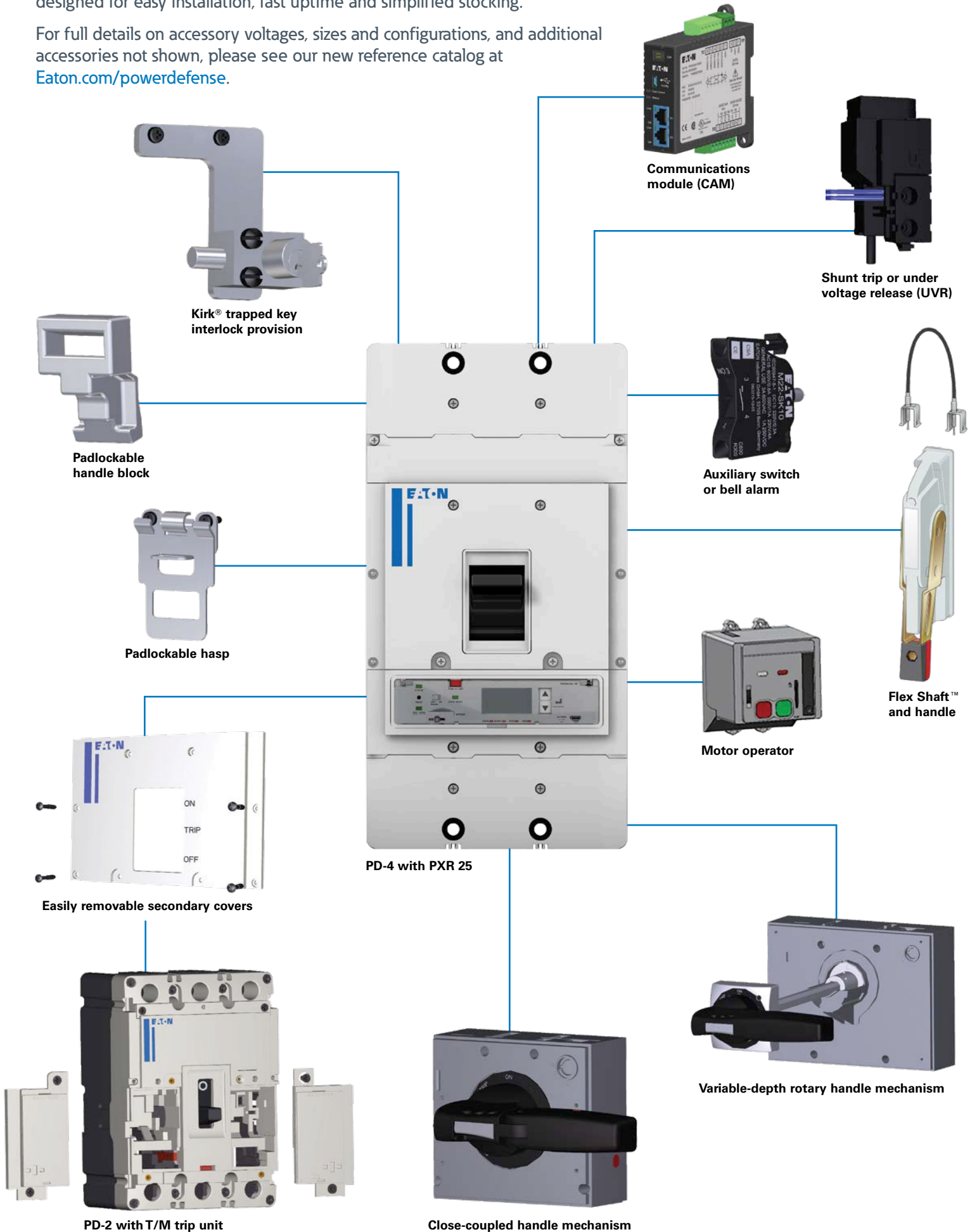

What will you build? And how will you defend it?



Eaton's MCCB product selector

- Web interface to assist in breaker detail selection
- Adjusts for mobile access
- Downloadable 2D and 3D models in over 80 different formats
- Downloadable technical data sheets

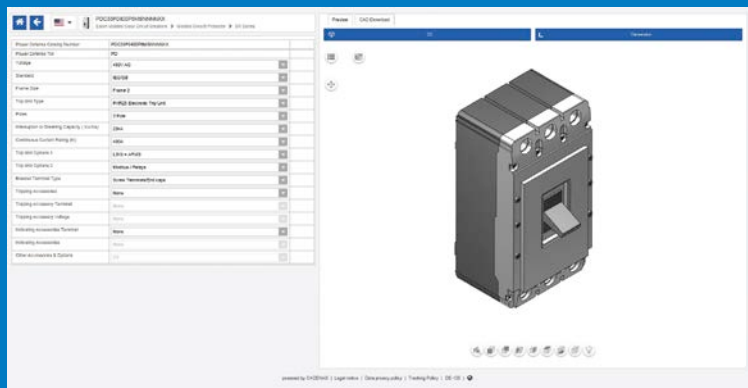
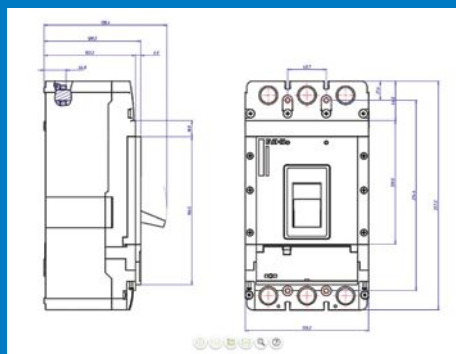



**Our defense is
your best offense.**

When Power Defense MCCBs safeguard your structure's power system, you are getting the latest protection technology, engineered for the future: Industry 4.0 features such as built-in communications, advanced energy metering and algorithms that notify you when your circuit breaker needs maintenance, as well as zone selective interlocking technology that clears faults quickly and locally, preventing propagation into your system. Arc flash reduction options help protect your people with the fastest tripping speed technology, not to mention Eaton's best-in-class support and service. You are freeing yourself and your customers from concerns and gaining the sort of assurance that allows your people to move and plan with confidence. That's why our defense is your best offense.

Power Defense



A globally rated platform from Eaton.

**For more information, call 1-877-ETN-CARE (1-877-386-2273),
or visit [Eaton.com/powerdefense](https://www.eaton.com/powerdefense)**

Eaton
1000 Eaton Boulevard
Cleveland, OH 44122
United States
[Eaton.com](https://www.eaton.com)

© 2018 Eaton
All Rights Reserved
Printed in USA
Publication No. BR012013EN / Z21313
August 2018

Eaton is a registered trademark.

All other trademarks are property
of their respective owners.

Follow us on social media to get the
latest product and support information.

