

# First Notice



## Safety Notice

Mandatory Action Required

170002

North America  
Asia-Pacific  
TLA  
MEXCAC



**Date:** February 27, 2017

**Models Affected:** GS-3232  
GS-4047  
X-14

**Serial Numbers Affected:** See Tables 1a and 1b on pages 2 and 3

**Subject:** Control System Malfunction

**Allowable Hours:** Software Upgrade Only: 30 minutes  
Control System and Software Upgrade: 60 minutes

---

### Issue:

Genie has determined that the control system utilized on the above referenced machines can malfunction. A malfunctioning control system can result in the issues listed below:

- **GS-3232:** This control system malfunction allows the operator to lift and drive the machine with the platform raised above the maximum allowable travel height of 22 ft / 6.7 m. **A machine that is driven with the platform raised above 22 ft / 6.7 m can cause the machine to lose stability resulting in a tip over.**

**Note: This Safety Notice supersedes Safety Notice 120013 issued on October 15, 2012.**

- **GS-4047 and X-14:** This control system malfunction can cause the platform to lower after the controls are released, resulting in unintended machine movement. **Unintended machine movement can result in a hazardous situation.**

### Action(s) Required:

- 1 Locate the affected machines referenced in tables 1a and 1b on pages 2 and 3 within your fleet.
- 2 Using tables 1a and 1b, determine the appropriate action for your machine.

# First Notice



	<h2>Safety Notice</h2> <p><i>Mandatory Action Required</i></p>	<h1>170002</h1>	
		<p>North America Asia-Pacific TLA MEXCAC</p>	

Table 1a. Affected Serial Numbers, GS-3232

Serial Range	Action	
<p><b>GS-3232:</b> GS3214A-135001 to 136593 GS3215A-136597 to 142004 GS3216A-142008 to 142674 GS3216P-142678 to 146926</p>	<p>Update software; Follow "Work Instructions" starting on page 5.</p>	
<p>Note: The machines below were shipped from the factory with the 2-Speed Lift control system. In 2014, Genie released "SmartLink Proportional Lift" control system upgrade kits for these machines. Some of these machines may have been upgraded with the Proportional Lift control system. Inspect the P-Con to determine the control system installed on these machines.</p>		
<p><b>GS-3232:</b> GS3211A-110000 to 110006 GS3212A-110007 to 112760 GS3213A-112773 to 117699 GS3214A-117702 to 120641</p>	<p>P-Con, Proportional Lift</p> 	<p>Update software; Follow "Work Instructions" starting on page 5.</p>
	<p>P-Con, 2-Speed Lift</p> 	<p>Update control system; Order the appropriate "Control Box Upgrade Kit". Refer to table 2 on page 4.</p> <p>Note: The software will be updated as part of the upgrade process.</p>

# First Notice

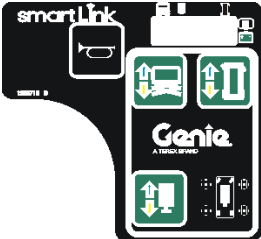
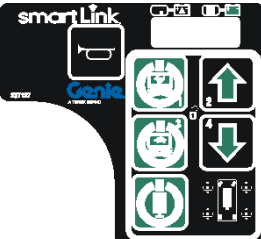

	<h2>Safety Notice</h2> <p>Mandatory Action Required</p>	<h1>170002</h1>	
		<p>North America Asia-Pacific TLA MEXCAC</p>	

Table 1b. Affected Serial Numbers, GS-4047 and X-14

Serial Range	Action
<p><b>GS-4047:</b> GS4714C-1800 to 1877 GS4715C-1878 to 2632 GS4716C-2633 to 3530 GS47C-4500 to 4553</p> <p>GS4714D-300 to 336 GS4715D-337 to 1305 GS4715D-1306 to 1326 GS4716D-1306 to 3855 GS47D-3960 to 4937</p> <p>GS4716P-101 to 204 GS47P-1000 to 1236</p> <p>GS4716-2176 to 3409</p> <p><b>X-14:</b> X1415D-101 to 142 X1416D-143 to 240</p>	<p>Update software; Follow "Work Instructions" starting on page 5.</p>

Note: The machines below were shipped from the factory with the 2-Speed Lift control system. In 2014, Genie released "SmartLink Proportional Lift" control system upgrade kits for these machines. Some of these machines may have been upgraded with the Proportional Lift control system. Inspect the P-Con to determine the control system installed on these machines.

<p><b>GS-4047:</b> GS4712C-101 to 439 GS4713C-440 to 1006 GS4714C-1007 to 1799</p> <p>GS4714D-101 to 299</p>	<p>P-Con, Proportional Lift</p> 	<p>Update software; Follow "Work Instructions" starting on page 5.</p>
	<p>P-Con, 2-Speed Lift</p> 	<p>Update control system; Order the appropriate "Control Box Upgrade Kit". Refer to table 2 on page 4.</p> <p>Note: The software will be updated as part of the upgrade process.</p>

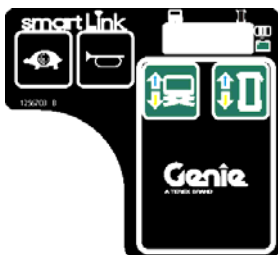
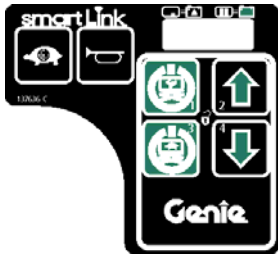
# First Notice



	<h2>Safety Notice</h2> <p><i>Mandatory Action Required</i></p>	170002	
		North America Asia-Pacific TLA MEXCAC	

Table 2. Control Box Upgrade Kits for GS-3232 and GS-4047 models

Certification	Kit PN (GS-3232)	Kit PN (GS-4047)
ANSI/CSA with word decals	1258337GT	N/A
ANSI/CSA with symbol decals	1258516GT	1258515GT
EN280	1258339GT	1258334GT
AUS	1258338GT	1258384GT

**Completion of this Safety Notice must be done as soon as possible but no later than 30 days from receipt of the software upgrade file or control system upgrade kit.**

- Fill out and sign the completion form attached to the installation instructions and fax or email to Terex AWP Warranty Department. This will serve as verification that you have completed this Safety Notice.

### Continued Use Instructions:

**All machine operators and users must be notified of these continued use requirements.**

**The machines may remain in service while waiting for this software update or control system upgrade provided that the following requirements are performed.**

#### Model GS-3232:

- Perform the machine's function test and pre-operational inspection prior to each use.
- Do not raise the platform unless all four outriggers are properly lowered.

#### Model GS-4047 and X-14:

- Perform the machine's function test and pre-operational inspection prior to each use.
- During function test and operation, if the platform continues to lower after releasing a control, push the Red Emergency Stop button and immediately remove the machine from service until this Safety Notice is completed.

# First Notice

	<b>Safety Notice</b> <i>Mandatory Action Required</i>	<b>170002</b>	<b>Genie</b> A TEREX BRAND
		North America Asia-Pacific TLA MEXCAC	

## Work Instructions:

- 1 Access <http://firmware.genielift.com> .

### MACHINE SOFTWARE DOWNLOAD

Welcome to the Genie Machine Software Download portal. This portal is created for you to download the control system software for your Genie equipment. Please use the search filters below to locate the machine software you wish to download.

Safety Notice:

Machine Model:

Controller Type:

Serial Number:

Part Number:

- 2 Select "Safety Notice".

### MACHINE SOFTWARE DOWNLOAD

Welcome to the Genie Machine Software Download portal. This portal is created for you to download the control system software for your Genie equipment. Please use the search filters below to locate the machine software you wish to download.

Safety Notice:

Safety Notice Number:

- 3 Enter "170002" in the "Safety Notice" Number box and click on "Search".



### MACHINE SOFTWARE DOWNLOAD

Welcome to the Genie Machine Software Download portal. This portal is created for you to download the control system software for your Genie equipment. Please use the search filters below to locate the machine software you wish to download.

Safety Notice:

Safety Notice Number:

# First Notice

	<b>Safety Notice</b> <i>Mandatory Action Required</i>	<b>170002</b>	
		North America Asia-Pacific TLA MEXCAC	

- 4 Under the "Application Firmware" column, download and save the firmware file by clicking on the 1256792(REV\*).zip link.

Where REV\* = L or higher

## MACHINE SOFTWARE DOWNLOAD

Your search yielded 1 results.

Safety Notice #	Application Firmware	Kernel Software	Bootloader Firmware	Service Tool Software	Safety Notice
170002	Firmware File: 1256792(REV*) Instructions: PN1278628GT	N/A	N/A	N/A	Safety Notice Instructions: 170002

1/1 10

Important: Note the location on the computer where you downloaded the file. You will need it when performing the software update.

- 5 Update the software installed on your machine using instructions PN 1278628GT.

### To order parts:

Machine owners with a valid Genie account can contact the Terex AWP Parts Department to place an order through one of the following:

Genie Website:  
<https://www.gogenielift.com/default.aspx>  
Fax: 1-888-274-6192  
Phone: 1-800-536-1800

Machine owners without a valid Genie account can contact their nearest Terex AWP dealership or Terex AWP Service Centers for assistance.

Search for your nearest Terex AWP dealership by visiting our website at:

<http://www.genielift.com/dealersearch/>

# First Notice



## *Safety Notice*

*Mandatory Action Required*

170002

North America  
Asia-Pacific  
TLA  
MEXCAC

**Genie**<sup>®</sup>  
A TEREX BRAND

### Warranty:

The labor and travel miles required to perform this Safety Notice are covered under the provisions of our LIMITED PRODUCT WARRANTY statement. Warranty claims can be submitted online, by paper claims, fax or email. If you need more information about filing a warranty claim, please contact Terex AWP Warranty Department at:

Email (North America):	AWP.Warranty@terex.com
Email (Asia-Pacific):	warranty.awpchina@terex.com
Email (Brazil):	AWP.Warrantybrazil@terex.com
Email (all others):	AWP.Warranty@terex.com
United States:	+ 1-800-536-1800
Canada:	+ 1-425-881-1800
Asia-Pacific:	+ 86 21 347028555
Brazil (Phone 1):	+ 55 11 3246-8121
Brazil (Phone 2):	+ 55 11 3246-8185
All other locations:	+ 1-425-881-1800

Genie and local industry standards (e.g. ANSI, CSA) requires that the seller of a Genie machine report to Genie the model and serial number of each machine sold, as well as the name, address, and telephone number of the new owner, within 60 days of the sale. Use the Owner Update Form attached to the bulletin to indicate the new location or status of any of your machines. You may also visit our website to register your machine.

[Machine Registration\\_ANSI http://www.genielift.com/en/service-support/product-registration/index.htm](http://www.genielift.com/en/service-support/product-registration/index.htm)

Genie, OSHA and local industry standards, also require that the manufacturer's Safety Notice be completed. It is your responsibility to communicate this important information to all machine owners and applicable branches. If you require additional copies of this Safety Notice or have any questions, please contact Genie Product Support at:

United States:	+ 1-800-536-1800
Canada:	+ 1-425-881-1800
Asia-Pacific:	+ 86 21 347028555
Brazil (Phone 1):	+ 55 11 3246-8121
Brazil (Phone 2):	+ 55 11 3246-8185
All other locations:	+ 1-425-881-1800

### Enclosures:

- Machine List
- New Owner Update Form
- Instructions,1278628GT



# Safety Notice 170002

## New Owner Update Form (for updating machine owner information only)

Genie and ANSI requires that the seller of a Genie machine report to Genie the model and serial number of each machine sold, as well as the name, address, and telephone number of the new owner, within 60 days of the sale.

- If you have sold a machine, list new owner's name, address and phone number, for each machine. List complete model and serial number (ex. GS3214A-135405, GS4714C-1868, X1416D-147)

**New Owner Information:**

	Machine 1	Machine 2	Machine 3
Model*	<hr/>	<hr/>	<hr/>
Serial Number *	<hr/>	<hr/>	<hr/>
Owner Name*	<hr/>	<hr/>	<hr/>
Address 1*	<hr/>	<hr/>	<hr/>
Address 2	<hr/>	<hr/>	<hr/>
City/State/Zip*	<hr/>	<hr/>	<hr/>
Phone Number*	<hr/>	<hr/>	<hr/>
Contact Person	<hr/>	<hr/>	<hr/>

\* Required fields

**Seller Information:**

Date: 

---

Company Name: 

---

Account #: 

---

Address: 

---

(street): 

---

(city): 

---

(state, zip code): 

---

Phone #: 

---

- List any machines that could not be inspected or repaired because of the following:

Model & Serial Number	Scrapped	Exported	Stolen	Other (explain)
<hr/>	-	-	-	<hr/>
<hr/>	-	-	-	<hr/>
<hr/>	-	-	-	<hr/>
<hr/>	-	-	-	<hr/>

<b>Fax to:</b>	United States:	1 877-738-7530	Latin America:	+ 55 11 3246-9760
	Canada:	1 425-498-7530	Central America:	+ 1 425 498 7530
	Mexico:	1 425-498-7530	Asia-Pacific:	+ 1 425 498 7530
	Caribbean:	+ 1 425 498 7530	All other locations:	+ 1 425 498 7530





# ***Installation Instructions***

## ***Software Update***

**GS-3232**

**GS-4047**

**X-14**

Part No. 1278628GT  
Rev A

## Introduction



### Observe and Obey:

- This procedure shall be completed by a person trained and qualified on the repair of this machine.
- Immediately tag and remove from service a damaged or malfunctioning machine.
- Repair any machine damage or malfunction before operating the machine.

### Before Starting Installation:

- Read, understand and obey the safety rules and operating instructions in the appropriate operator's manual.
- Be sure that all necessary tools and parts are available and ready for use.
- Read this procedure completely and adhere to the instructions. Attempting shortcuts may produce hazardous conditions.
- Indicates that a specific result is expected after performing a series of steps.
- Indicates that an incorrect result has occurred after performing a series of steps.

**Note: These installation instructions only apply to the Genie models listed on the front cover, as required by Safety Notice 170002.**

### Tools Required:

#### Tools Required

- Torx T10 screwdriver
- Cat5 Ethernet Cable
- PC or Laptop with an Ethernet Port and Internet Browser

### Glossary of Terms

ECM - Electronic Control Module

GCON - Ground Controller. This ECM is located at the ground controls.

PCON - Platform Controller. This ECM is located at the platform controls.

CAT5 Cable - Standard Ethernet cable used for networking purposes.

If you have any further questions regarding these instructions or need assistance, please contact Genie Product Support at one of the following telephone numbers:

United States:		800-536-1800
Canada:		425-881-1800
Europe:	UK	+ 44 1476 584 333
	France	+ 33 237 260 986
	Germany	+ 49 4221 491 810
	Iberica	+ 34 935 725 090
	Italy	+ 39 075 941 8132
	Scandinavia	+ 46 3157 5154
	Other locations	+ 31 653 221 908
Middle East:		+ 97 143 391 800 or + 97 150 459 7937
Australia:		+ 61 7 3456 4444
All other locations		+ 1-425-881-1800

## Procedure

### Loading or Updating Machine Software

Note: There are two procedures available to update the machine software. These are Bootloader Mode and Machine Application Mode.

**Bootloader Mode:** The Bootloader mode is only available with the key switch in the GCON position. It allows the user to update or reinstall the machine software by directing the system into the Bootloader.

Choose this mode if the GCON ECM is not operating correctly.

**Machine Application Mode:** The machine Application mode is available with the key switch in the GCON or PCON position. This mode of machine software update requires the user to enter the Machine Service Tool.

Choose this mode if the machine is operating correctly and you are updating the machine software.

### Bootloader Mode

- 1 Open the GCON compartment.

Note: Some models will require opening the ground control box to access the GCON.

- 2 Turn the key switch to the ground controls position and pull out the red Emergency Stop button to the on position at the platform controls.
- 3 At the ground controls, press and hold the Enter and Escape buttons.

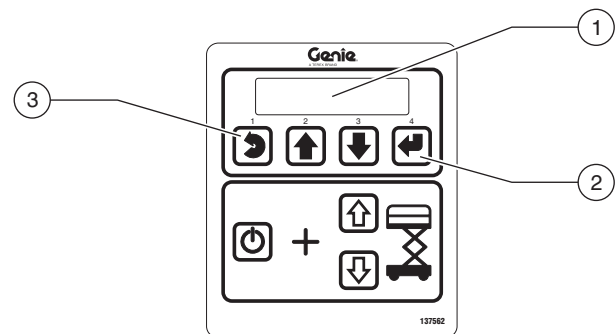

- 1 LCD display
- 2 enter button
- 3 escape button

- 4 Pull out the red Emergency Stop button to the on position at the ground controls.
- ⦿ Result: The ground controls LCD display will show the following:



# Procedure

- 5 Locate the diagnostic port on the side of the GCON. Remove one of the fasteners securing the cover and set aside. Loosen the other fastener. Do not remove it.

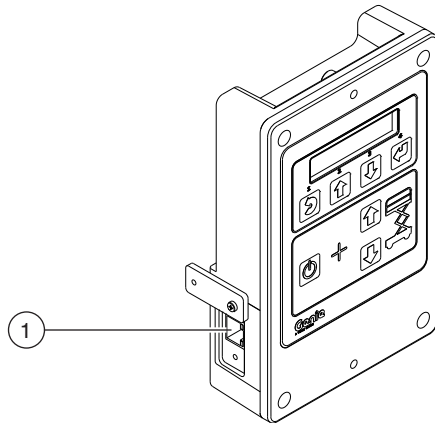

1 diagnostic port

- 6 Connect one end of a CAT5 Ethernet cable into the diagnostic port. Connect the other end into a PC or laptop.
- Result: The ground controls LCD display will show the following:



- 7 Read and record the IP address.
  - 8 Launch a web browser such as Internet Explorer®, Chrome® or Firefox® on your PC or laptop. Type the IP address from step 7 into the web browser address bar and press enter.
- Result: The following screen will be displayed.



- 9 Select the **Choose File** button and navigate to the downloaded Genie Flash file (.gff).

Note: Verify it is the correct flash file.

- 10 Select the **Load Flash File** button to verify the file is a .gff file.
- Result: The following screen will be displayed.

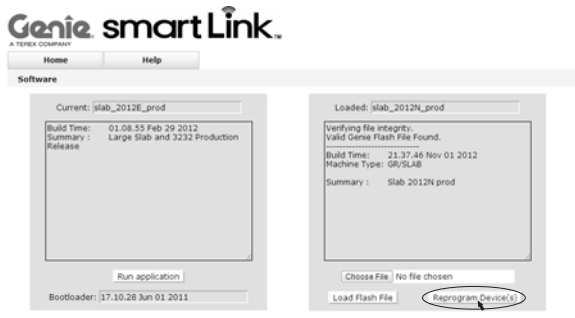

## Procedure

- 11 Select the **Reprogram Device(s)** button to start the ECM software update.
- ☉ Result: The following screen will be displayed after the software update is complete.

Note: Do not turn off power while the ECM is being reprogrammed.



- 12 Select the **Run Application** button to exit the software update mode.
- 13 Push in the red Emergency Stop button and disconnect the CAT5 cable from the GCON.

- 14 Secure the diagnostic port cover using the retaining fasteners removed in step 5. Do not over tighten.

Note: Machines equipped with AGM batteries will need to select the AGM battery type using the GCON set parameters screen. Refer to the *Machine Setup* procedure in the Service and Repair manual that is appropriate for your machine.

### ⚠ WARNING

Tip over hazard. Updating the SmartLink software may have impacted the machines default drive speeds. Tipping over the machine will result in death or serious injury.

Perform drive speed test. Refer to the *Maintenance Manual* that is appropriate for your machine.

- 15 Perform a function test. Refer to the Operator's Manual on your machine.
- 16 Return the machine to service.
- 17 Fill out and sign the attached completion form and fax or email to Terex AWP Warranty Department. This will serve as verification that you have completed Safety Notice 170002.

# Procedure

## Machine Application Mode

- 1 Open the GCON compartment.

Note: Some models will require opening the ground control box to access the GCON.

- 2 Turn the key switch to ground controls or platform controls and pull out the red Emergency Stop button to the on position at both ground and platform controls.
- 3 Locate the diagnostic port on the side of the GCON. Remove one of the fasteners securing the cover and set aside. Loosen the other fastener. Do not remove it.

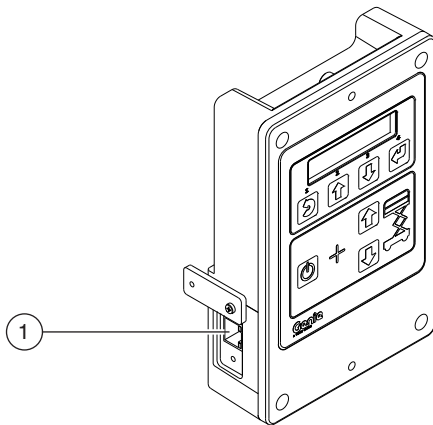

1 diagnostic port

- 4 Connect one end of a CAT5 Ethernet cable into the diagnostic port. Connect the other end into a PC or laptop.

- Result: The ground controls LCD display will show the following:



- 5 Read and record the IP address.

Note: The display will only show the IP address for 3 seconds. Press the scroll up button to display the IP address for another 3 seconds.



- 6 Launch a web browser such as Internet Explorer®, Chrome® or Firefox® on your PC or laptop. Type the IP address from step 5 into the web browser address bar and press enter.

- Result: The following screen will be displayed.

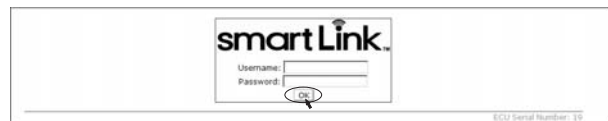

- 7 Enter the following username and password then select **OK**.

**Username: smart.link**

**Password: SL1000**

Note: The username and password are case sensitive.

- Result: The following screen will be displayed.

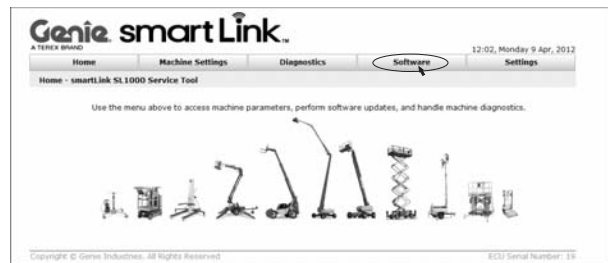

## Procedure

- 8 Select the **Software** tab at the header bar.
- Result: The following screen will be displayed.



- 9 Select the **Update Machine Software** button.
- Result: The following screen will be displayed.



- 10 Select the **Choose File** button and navigate to the downloaded Genie Flash file (.gff).

Note: Verify it is the correct flash file.

- 11 Select the **Load Flash File** button to verify the file is a .gff file.

- Result: The following screen will be displayed.



- 12 Select the **Reprogram Device(s)** button to start the ECM software update.

- Result: The following screen will be displayed after the software update is complete.

Note: Do not turn off power while the ECM is being reprogrammed.

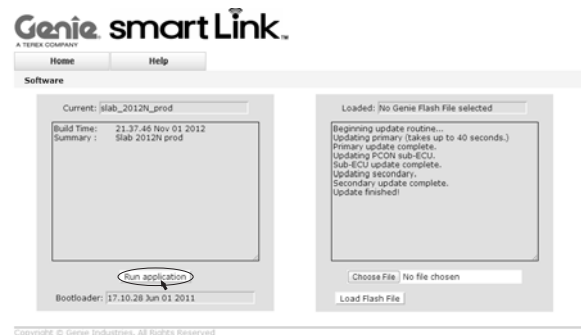

- 13 Select the **Run Application** button to exit the software update mode.

---

## Procedure

- 14 Push in the red Emergency Stop button and disconnect the CAT5 cable from the GCON.
- 15 Secure the diagnostic port cover using the retaining fasteners removed in step 5. Do not over tighten.

Note: Machines equipped with AGM batteries will need to select the AGM battery type using the GCON set parameters screen. Refer to the *Machine Setup* procedure in the Service and Repair manual that is appropriate for your machine.

**⚠ WARNING** Tip over hazard. Updating the SmartLink software may have impacted the machines default drive speeds. Tipping over the machine will result in death or serious injury.

Perform drive speed test. Refer to the *Maintenance Manual* that is appropriate for your machine.

- 16 Perform a function test. Refer to the Operator's Manual on your machine.
- 17 Return the machine to service.
- 18 Fill out and sign the attached completion form and fax or email to Terex AWP Warranty Department. This will serve as verification that you have completed Safety Notice 170002.





Safety Notice 170002

**Completion Form**

Your signature on this form will verify that you have completed Safety Notice 170002 on the machines listed below.

**Please note that this is not a Warranty Claim Form. A Warranty Claim Form must be submitted to the Terex AWP Warranty Department for reimbursement under the provisions of our standard warranty terms and conditions.**

**Fax to:**

United States:	1 877-738-7530	France:	+ 33 237 260 998
Canada:	1 425-498-7530	Germany:	+ 49 4221 491 820
Australia:	+ 61 733751002	Italy:	+ 39 075 941 8146
All other locations:	+ 1-425-498-7530	Iberica:	+ 34 935 725 080
		Scandinavia:	+ 46 3157 5104
		Middle East:	+ 97 143 990 382
		All other locations:	+ 31 165 510 826

**Email to: [AWP.Warranty@terex.com](mailto:AWP.Warranty@terex.com)**

Date: \_\_\_\_\_

Company Name: \_\_\_\_\_

Account # (if applicable): \_\_\_\_\_

Address: \_\_\_\_\_

(street): \_\_\_\_\_

(city): \_\_\_\_\_

(state, zip code): \_\_\_\_\_

Phone: \_\_\_\_\_

Please list the complete machine serial number (ex. GS3214A-135405, GS4714C-1868, X1416D-147).

Serial Number: _____	Serial Number: _____
_____	_____
_____	_____
_____	_____
_____	_____

Print (service manager)	Signature	Date
-------------------------	-----------	------