

FRONT VIEW

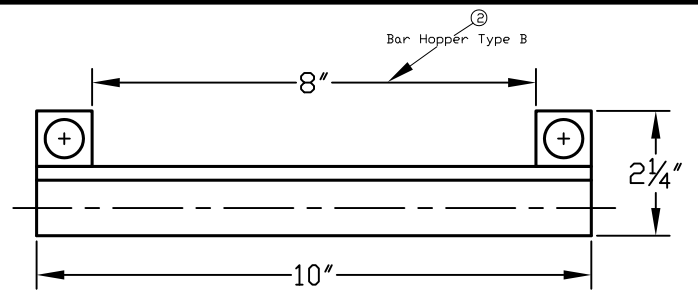

FRONT VIEW

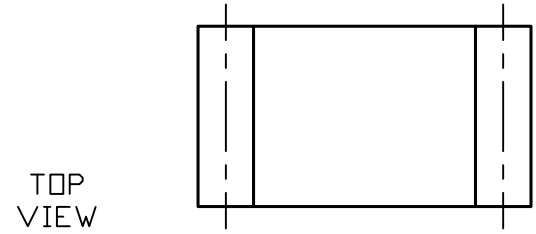

TOP VIEW

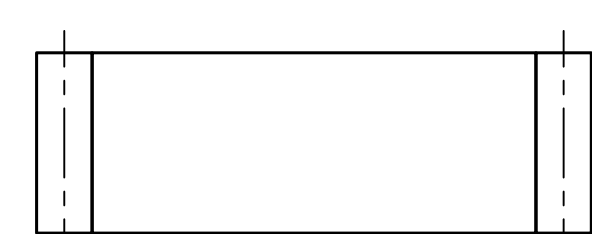

TOP VIEW

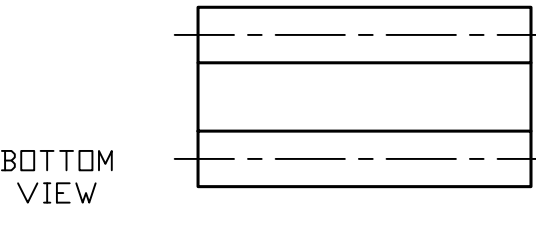

BOTTOM VIEW

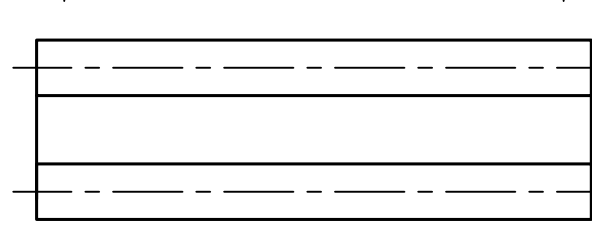

BOTTOM VIEW

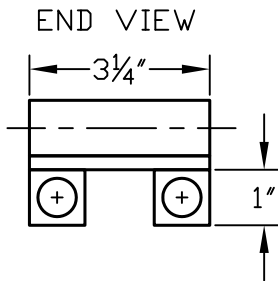

END VIEW

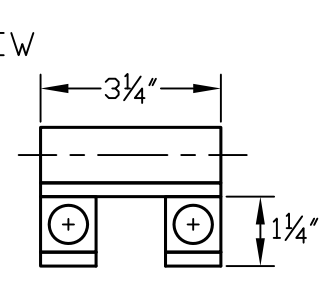

END VIEW

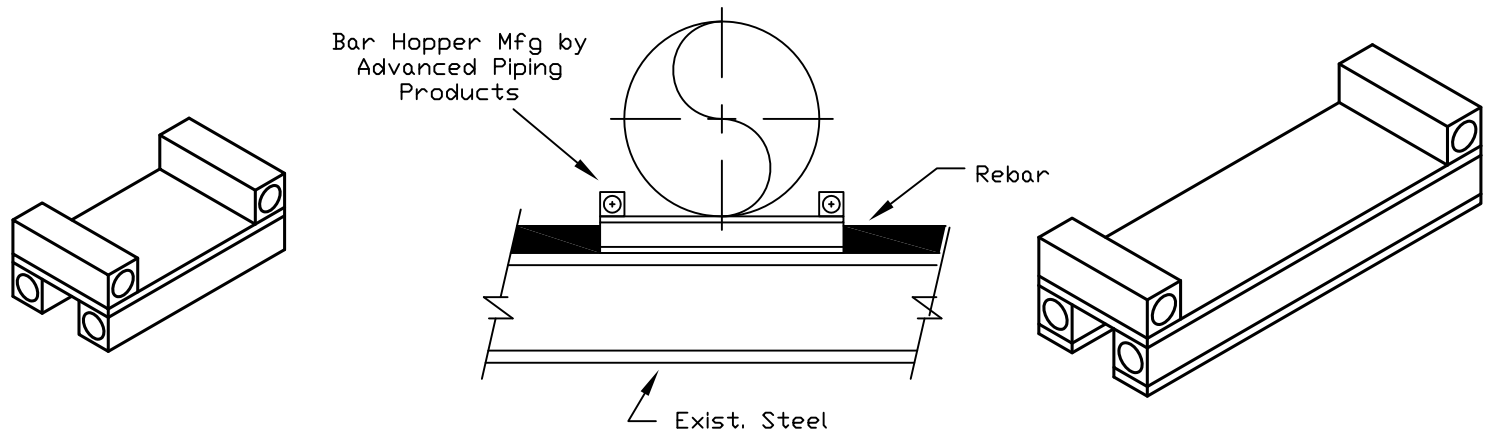

ITEM	QTY	DESCRIPTION	MATERIAL
1	1	Bar Hopper Type A	Vinyl Ester Resin
2	1	Bar Hopper Type B	Vinyl Ester Resin

CUSTOMER DATE: CD NAME: CONTACT: TEL. NO. E-MAIL: RFQ: PD: REF:	DWN.	DATE	03-23-15		<b>ADVANCED PIPING PRODUCTS</b> 5611 Guhn Road Houston TX, 77040 Tel. 713-956-2922 Fax 713-956-4090 www.appinc.co	
	CHK.					
	ENG.					
	MFG.					
	APPR.					
			DWG DESCRIPTION			
			Pipe Support Round Bar Insulator			
			SIZE	A	BHA0315 / BHB0315	REV. 0
			SCALE		None	SHEET 1 OF 1
			NEXT ASSY		QTY	