

# Transceiver Fiber Inspection and Cleaning

## Introduction

This document provides basic overview and background information for transceiver types that are commonly used in fiber networks.

## Fiber Connector Inspect/Clean/Connect Process

The requirement to inspect fiber connectors (and clean if necessary) before connection is strongly recommended in all cases; this includes the first use of new cables and transceivers or any equipment/panels with fiber interfaces.

### Inspect Before You Connect™ Process Flow:

Employ the Inspect Before You Connect process as per the following diagram and steps:

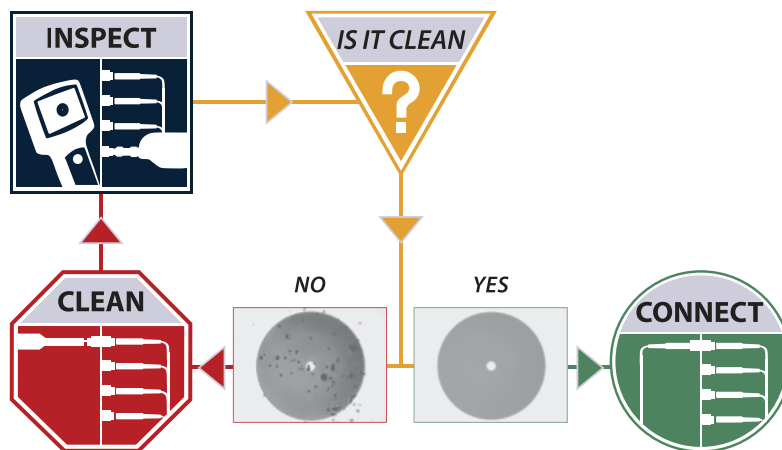

Figure 1. Inspect Before You Connect Process.

## Pluggable Optical Transceivers

### Overview

Fiber optic transceivers are highly variable in design and type: e.g. SFP, XFP, XENPAK, GBIC etc. Both the SFP and XFP have an LC connector interface; XENPAK and GBIC have an SC interface. QSFP transceivers typically have an MPO or LC interface. The key to inspecting transceivers is to understand that each port will either contain:

1. Ferrule / Fiber Stub
2. Physical Contact Lens Element
3. Non-Contact Lens Element

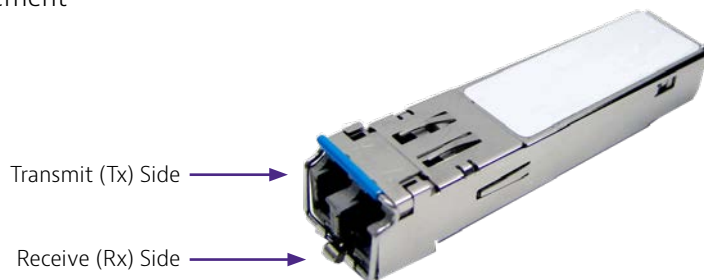

Figure 2. SFP Transceiver Port Orientation

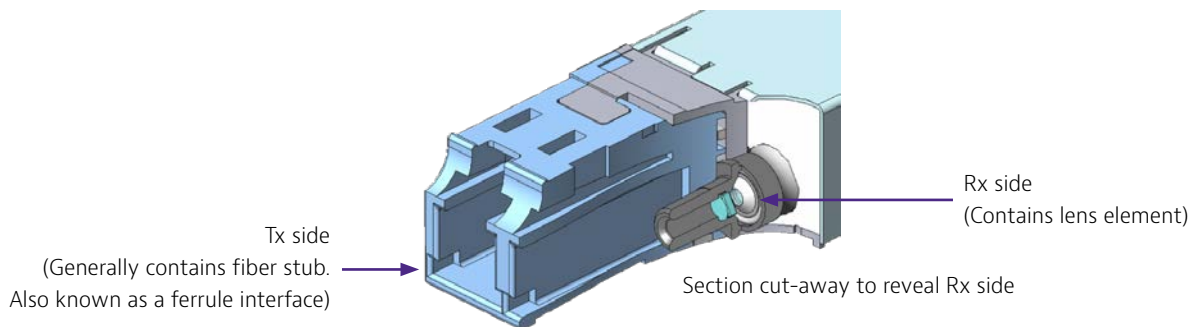

Figure 3. SFP Transceiver Cut-away View

### Ferrule / Fiber Stub

The Tx side of a single-mode transceiver is generally, but not exclusively, a *Ferrule or Fiber Stub Interface*, which is very similar to a bulkhead connector. When viewed with a video microscope, a ceramic ferrule end face will be seen.

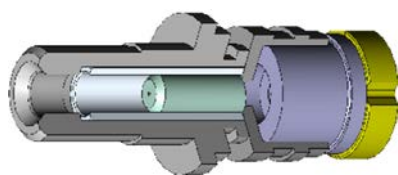

Figure 4. Ferrule/Stub Type

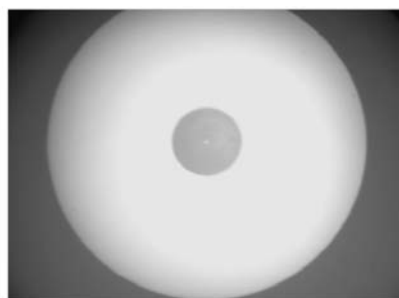

Figure 5. SFP Ferrule/Stub end face (clean)

## Ferrule/Stub Inspection and Cleaning

The process for inspecting and cleaning ferrule/fiber stub type transceivers is the same as is used for inspecting and cleaning standard fiber connectors located on patch cords or inside a bulkhead/mating adapter.

See page 8 for details.

## Lens Elements

The Rx port on the transceiver will typically be a lens interface, which has a very different appearance compared to a regular ferrule or fiber stub interface when inspected with a video microscope. When viewed with a video microscope, the lens is usually difficult to identify, especially if it is clean. Most multimode and some single-mode transceivers have a lens interface on both the Tx and Rx sides.

Lens interfaces can be categorized into two types: non-contact or physical contact, depending on whether the fiber connector makes contact with a lens element within the port.

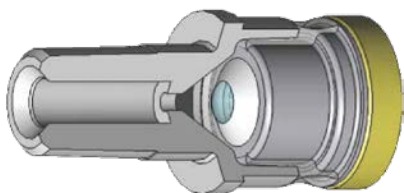

Figure 6. Non-Contact Lens Type

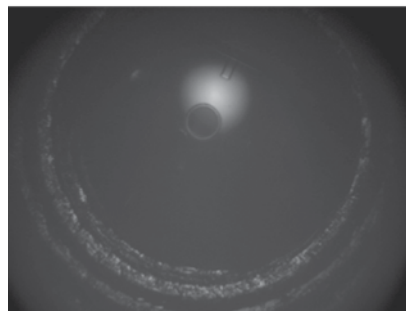

Figure 7. Microscope View of SFP Non-Contact Lens

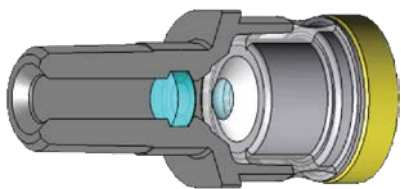

Figure 8. Physical Contact Lens Type

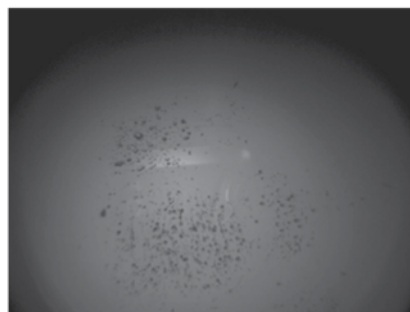

Figure 9. Microscope View of SFP Physical Contact Lens (dirty)

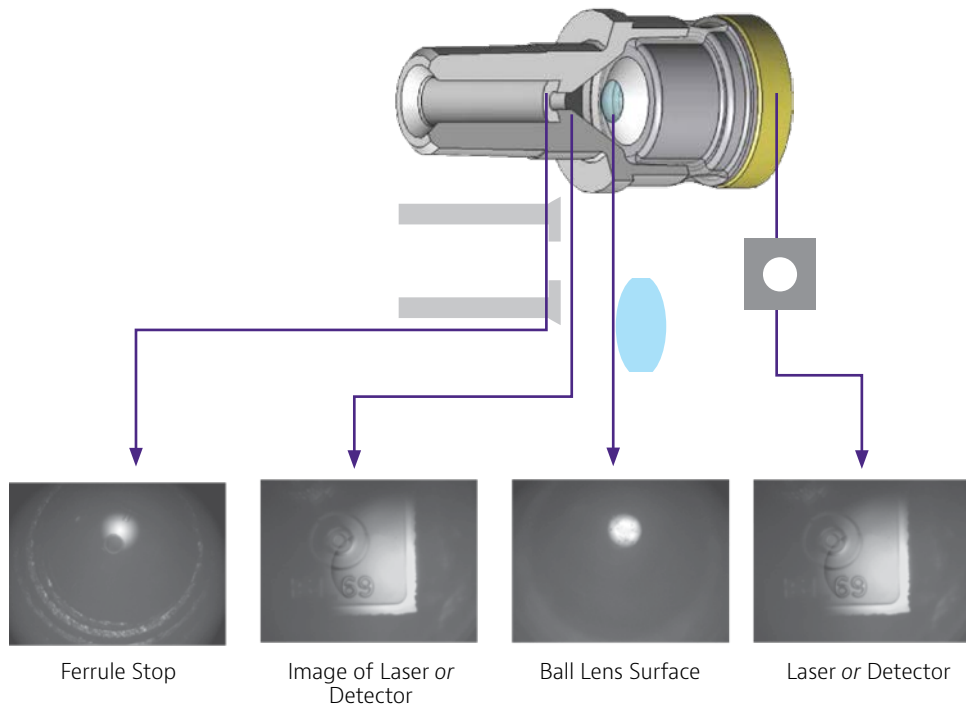

Figure 10. Example views of the Elements within Non-Contact Type Transceivers

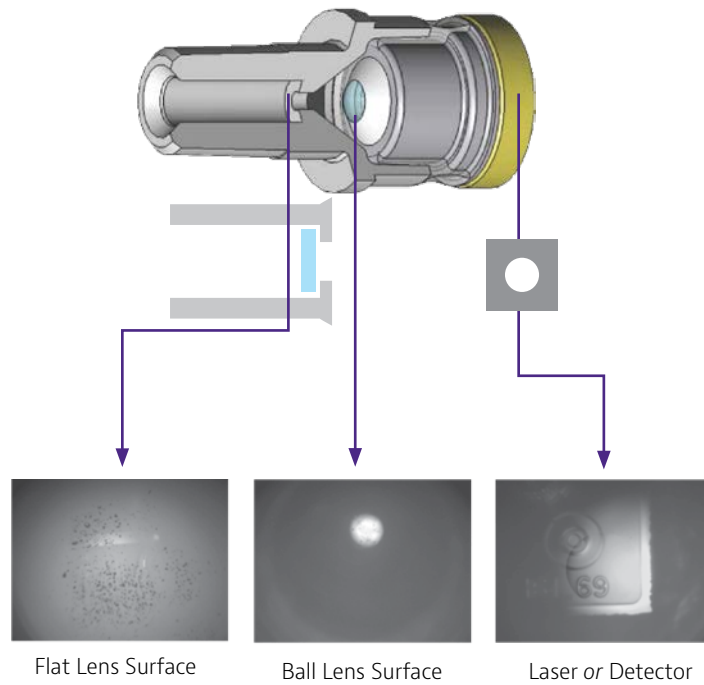

Figure 11 – Example views of Elements within PC Lens Type Transceivers

## Lens Element Inspection and Cleaning



1. Select the appropriate tip for the connector/adaptor you are inspecting. FBPT-LC-L is the recommended tip for LC-based SFP inspection.
2. Turn the focus wheel on the probe clockwise until you reach the end of the focal range. This is the rear-most position (deepest inside the SFP port).
3. Insert the microscope tip into the transceiver and turn the focus wheel counter-clockwise slowly, until an image comes into focus.
4. Depending on the type of the lens interface being inspected, different features will come into view – see Figures 10 and 11.
5. Inspect only the lens surfaces. Inspect all lens surfaces front and back.



Yes – If non-removable features are within acceptance thresholds, the SFP can be put into service.

No – If the port has a physical contact lens and the front of the lens is dirty, attempt to clean using the process below. If the contamination is on the back side of the lens, or on the ball lens at the bottom of the port, it is not possible to clean.

Note: Non-contact lens surfaces cannot be cleaned with standard cleaning tools. It may be possible to clean a physical contact lens surface, but only the front of the lens. It is not possible to clean the back side of the lens.

Currently there is no industry-accepted set of PASS/FAIL criteria for lens surfaces. The images in Figure 12 are examples of acceptable and unacceptable levels of non-linear, non-removable features on a lens surface, with associated return loss levels. If the transceiver does not perform to expected transmit level or receive sensitivity characteristics (dBm) according to relevant specifications, the associated device should be removed from service.



Acceptable (-45dB Interface RL)

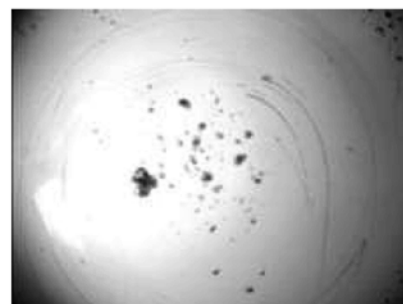

Unacceptable (-21dB Interface RL)

Figure 12 – Clean and Dirty Contact Lens Interface



### Notes about cleaning transceivers:

- To avoid the risk of damaging the transceiver lens coating, cleaning tools should be used gently and solvent sparingly.
  - The hardness of the lens coating differs between transceiver types and manufacturers.
1. Select the appropriate cleaning tool for the connector type.
  2. Insert the cleaning tool into the transceiver port and follow cleaning manufacturer instructions.
  3. **RE-INSPECT (see INSPECT section on page 5)**
  4. Determine whether clean or dirty.

***If clean***, the transceiver can be put into service. If dirty, repeat the cleaning process or replace the transceiver.

### Cleaning Non-Contact Lens Interfaces

1. Regular optical connector cleaning tools, based on physically contacting the endface surface, are not capable of cleaning non-contact optical interfaces.
2. Upon inspection – if non-contact optical interfaces, such as a ball lens, are identified during inspection, do not continue to inspect or attempt to clean. It is generally not a good use of time to inspect non-contact surfaces. The best way to determine if the transceiver is viable is to perform a loss test. Because there is no physical contact, there is no risk to test equipment or launch cables if the lens surface is dirty.
3. If the port does not perform to expected transmit level or receive sensitivity characteristics (dBm) according to relevant optical commissioning parameters, the associated device should be removed from service and handled according to relevant non-conformance procedure. If the transceiver's loss reading is within acceptable limits, the device can be put into service. Recovery options for non-contact lens surfaces are extremely limited.

## Non-Cleanable Transceiver Elements

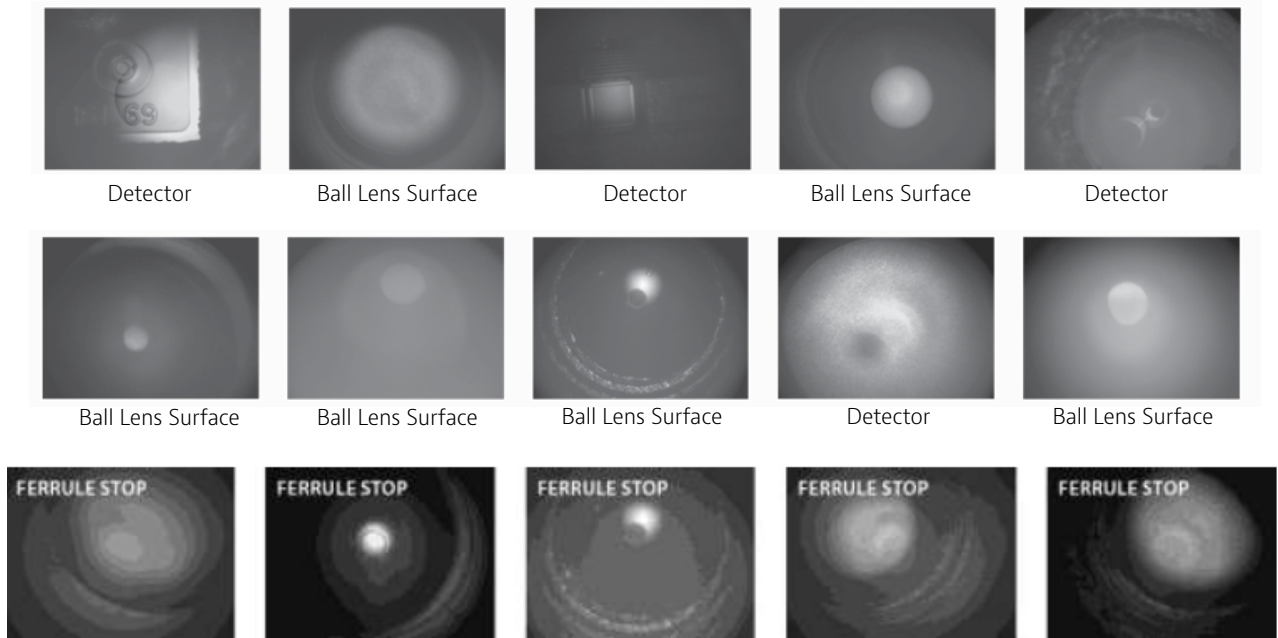
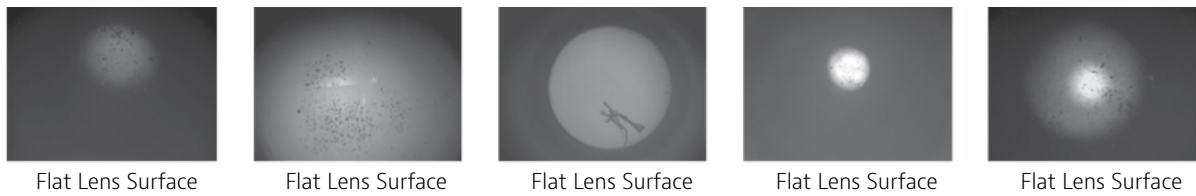

Figure 13. Examples of Images That May be Observed in Lens Type Interfaces

## Cleanable Transceiver Elements



Note that if a lens is completely free of defects it will be extremely difficult to determine when you are viewing the lens surface.

## Patchcord Inspection and Cleaning



1. Select the appropriate tip or adapter for the connector you are inspecting. Refer to the [Tip & Adapter Selection Guide](#) for more information.
2. Inspect both ends of the patch cord using the microscope or patch cord module (if using a VIAVI SmartClass Fiber inspection device.)



Yes – If surface defects are within acceptable limits, the fiber connector can be put into service.

No – Upon inspection, **if non-linear features are visible** on the end face, clean using an approved cleaning tool, and then re-inspect. See cleaning section below.



1. Select the appropriate cleaning tool for the connector type.
2. Open the lid of the **guide cap**.
3. Insert the connector into the cleaning tool and push in twice (two clicks).
4. **INSPECT** (see **INSPECT** section above)
5. Determine whether clean or dirty. **If clean**, do not touch it and connect. If dirty, either repeat DRY cleaning or go to WET-DRY cleaning (see below).
6. For WET-DRY cleaning, apply fiber optic cleaning solution onto a clean fiber wipe.
7. Wipe the end of the fiber connector on the wet area of the wipe, then go to STEP 3 above.

