



QUICK LINKS

[Table of Contents](#)
[RF Feeder](#)
[In-Building Wireless](#)
[Accessories](#)
[Technical Info](#)
[Part Number Index](#)

Edition 12
UPDATED: January 6, 2015



WIRELESS PRODUCTS
CABLE | CONNECTORS | ACCESSORIES



Our Commitment to Quality, Value and On-Time Delivery

Superior Essex® is a global leader in the design, manufacture, and supply of communications and cable products for both indoor and outdoor applications. We have cultivated a broad offering that includes premises optical fiber and copper cables, Outside Plant (OSP) cables, Fiber-to-the-Premises (FTTP) closures and enclosures, Fire Alarm and Security (FAS) cables, Low and Medium Voltage Energy cable products, and Wireless cables, connectors, and accessories. Our solid reputation for delivering quality products and service makes Superior Essex the preferred supplier for many of the major communications service providers, leading enterprises, universities, hospitals, military facilities and businesses that rely on our innovative solutions to keep pace with the demands of their evolving networks.



Since 2008, Superior Essex has been a part of LS Cable & System, one of the largest manufacturing corporations in Korea. With businesses centered in the energy, communications, plastics, fabrication, and automotive industries, LS has several manufacturing facilities located around the world.

Superior Essex has TL 9000 and ISO 9001:2001 certification in every communications production facility, assuring a level of quality and consistency in both products and customer service. We also manufacture custom products with special requirements, so our Product Management team can quote and deliver unique designs that are tailored for your applications. Beyond our quality assurance, value, and flexibility, we guarantee on-time delivery of the products you request.



As part of the LS Corporation, Superior Essex has added Radio Frequency (RF) transmission and Distributed Antenna Systems (DAS) products to the communications portfolio. The extensive selection of communications systems and products includes coaxial cables, connectors, and accessories for commercial wireless cell tower and in-building infrastructures across a wide range of vertical industries, such as hospitals, corporate offices, hotels, and government buildings.



RF Transmission and DAS Product Advantages

With wireless technology becoming the primary communication method, it is crucial to choose products that support new frequency spectrums and faster data rates. All of the Superior Essex RF transmission and DAS products were developed to work in modern, heterogeneous wireless networks (HetNets). A few of the advantages are listed below.



EXCELLENT ELECTRICAL CHARACTERISTICS

Our wireless cable series has excellent electrical characteristics such as low attenuation and low passive intermodulation (PIM), while also handling high frequency and high power.



FAST AND EASY INSTALLATION

Our wide range of DIN and N Type connectors and cable preparation tools are designed for fast and easy cable installations with consistent quality.

FIELD PROVEN PERFORMANCE

With a complete line of cable, connectors and accessories, Superior Essex wireless products have become the total solution for some of the largest and most demanding cellular service providers in the world.



EXCEPTIONAL PRODUCT QUALITY AND SERVICE

Customers choose Superior Essex RF transmission and DAS products for their exceptional quality and performance. These products have achieved or exceeded compliance with all applicable industry standards.

In addition, we bring you an American-based technical support staff that is prepared to assist with training, as well as answer product application questions. See our complete portfolio of RF transmission and DAS products within the following pages.

Application Guide for Self-Supporting Tower with RF Products

Cable, Connectors, Jumpers and Accessories

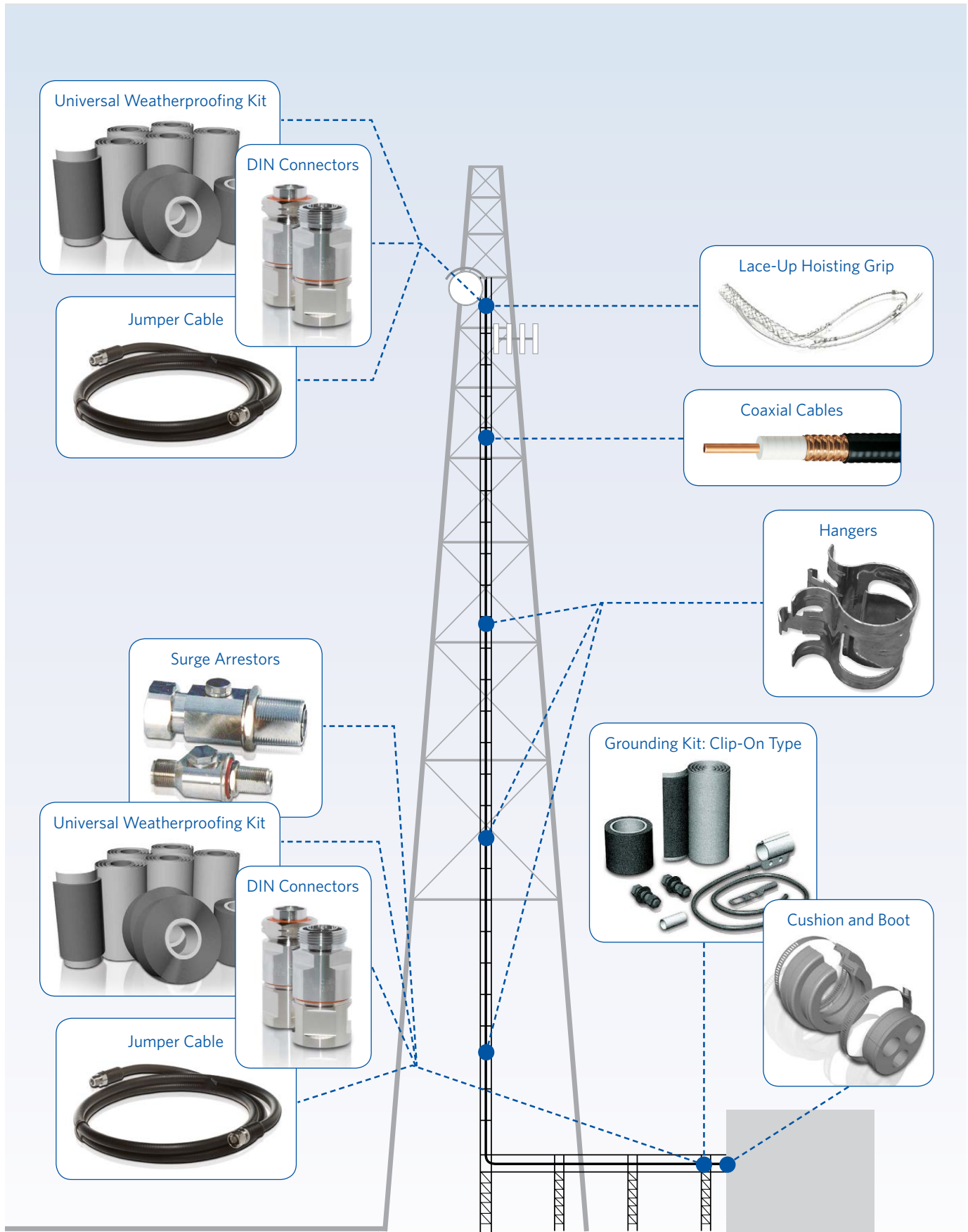

Application Guide for In-Building DAS Products

Cable, Connectors, Jumpers and Accessories

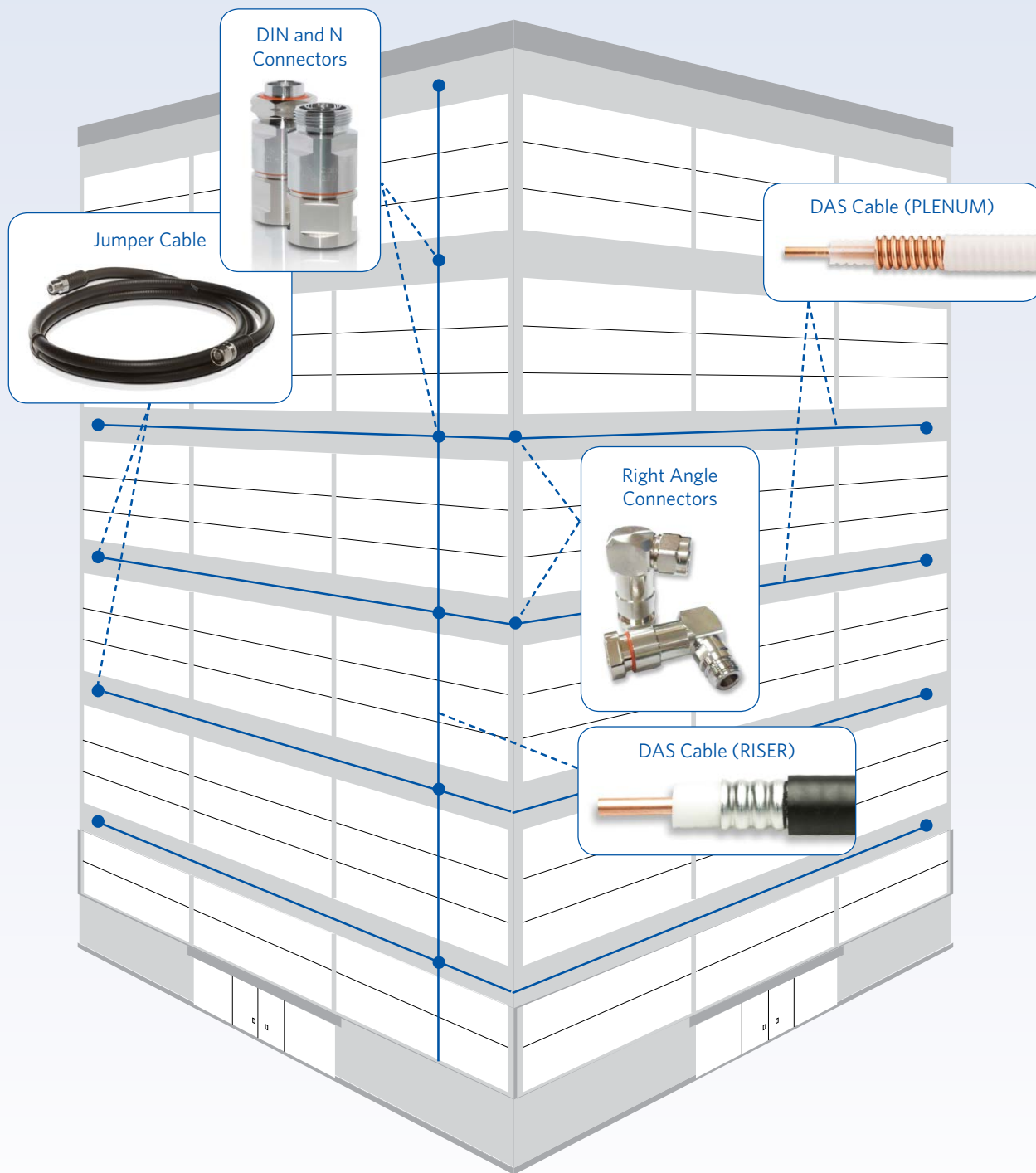



800.551.8948 | 770.657.6000
SuperiorEssex.com

All information, content, data, specifications, packaging and part numbers detailed herein are subject to change. For the most up to date information, please visit SuperiorEssex.com

RF FEEDER CABLE AND JUMPERS

LHF Series Low Loss High Flexible Foam Dielectric FeederD-2
LHF (White Jacketed) Series
Low Loss High Flexible Foam Dielectric FeederD-3
LHF Series (Ultimate High Performance)
Ultimate Low Loss High Flexible Foam Dielectric FeederD-4
HFSC Series Super Flexible Foam Dielectric FeederD-5
Fiber-to-the-Antenna (FTTA).....D-6
RF Jumper CableD-7

RF CONNECTORS

DIN Series for LHFD-8
DIN Series for HFSC.....D-9
N Series for LHF.....D-10
N Series for HFSC.....D-11

IN-BUILDING WIRELESS CABLE AND JUMPERS

DAS Hybrid Fiber + CopperD-12
DAS Hybrid, Interlock Armored Fiber + CopperD-13
LHF Riser Low Loss High Flexible Foam Dielectric FeederD-14
LHF Plenum Low Loss High Flexible Air Dielectric FeederD-15
HFSC Riser Super Flexible Foam Dielectric FeederD-16
HFSC Plenum Super Flexible Air Dielectric FeederD-17
HFAC Riser Low Loss High Flexible Foam Dielectric FeederD-18
HFAC Plenum Low Loss High Flexible Air Dielectric FeederD-19
DAS Riser Jumper Cable.....D-20
DAS Plenum Jumper Cable.....D-21

IN-BUILDING WIRELESS CONNECTORS

DIN Series for LHFD-22
DIN Series for HFSC.....D-23
DIN Series for HFAC.....D-24
N Series for LHF.....D-25
N Series for HFSCD-26
N Series for HFAC.....D-27

WIRELESS ACCESSORIES

Cable Preparation Tools.....D-28
Cushion and Boot Assembly KitD-29
Universal Weatherproofing KitD-30
Hoisting Grip Lace-Up and Pre-Laced.....D-31
Clip-On Grounding KitD-32
Universal Snap-in Hanger Kit.....D-33
Stackable Snap-in Hanger KitD-34
Standard Hanger Kit.....D-35
 $\lambda/4$ Wave Surge Arrestor.....D-36
Gas Tube Surge Arrestor.....D-37
Round Adapter Kit.....D-38
Stand-Off Adapter KitD-39
Angle Adapter Kit.....D-40
Three-Way Stand-Off Adapter KitD-40
Ground Bus Bar KitD-41
Weather Proofing ShellD-42
Anti-Theft Hardware KitD-43

TECHNICAL INFO

Metric Conversions.....X-2
American Wire Gauge Sizes.....X-2
Standard and Cut To Length Wood Reels.....X-3
Cable and Prep Tool MatrixX-4
Optical Fiber Types.....X-5
Optical Fiber Selection Chart.....X-6
Terms and Conditions of SaleX-8
Part Number Index.....X-9

LHF Series

Low Loss High Flexible Foam Dielectric Feeder



PRODUCT DESCRIPTION

LHF Series cables are low loss 50 Ohm cables featuring a foamed polyethylene dielectric, annularly corrugated copper shield and polyethylene jacket.

FEATURES

- Low attenuation
- Low passive intermodulation
- Easy connectorization
- Factory tested and inspected
- Rugged and durable

BENEFITS

- Suitable for long cable runs
- Outperforms the industry requirements for low passive intermodulation
- Full line of high-quality low intermodulation DIN and N connectors and cable preparation tools minimize installation time and expenses
- 100% of all RF cables are inspected and tested to meet or exceed industry specifications including passive intermodulation
- High-quality materials result in rugged cables that are able to withstand extreme environments without corrosion

SPECIFICATIONS

Inner Conductor	LHF-12D: Copper-clad aluminum wire LHF-33D: Smooth copper tube
Dielectric	Foamed polyethylene
Outer Conductor	Annularly corrugated copper tube
Jacket	Black polyethylene
Recommended Operating Temperature °F (°C)	-40 to +185 (-40 to +80)

PART NUMBERS AND PHYSICAL CHARACTERISTICS

Part Number	Cable Size in (mm)	Nominal Diameter in (mm)				Minimum Bend Radius in (mm)	Approx. Weight lbs/kft (kg/km)	Flat Plate Crush Resistance lbs/in (kg/mm)	Maximum Pulling Force lbs (kg)
		Inner Conductor	Dielectric	Outer Conductor	Jacket				
LHF-12D	½ (12)	0.20 (5.0)	0.49 (12.5)	0.56 (14.2)	0.65 (16.4)	4.92 (125)	163 (244)	112 (2.0)	249 (113)
LHF-33D	1¼ (33)	0.54 (13.7)	1.32 (33.6)	1.43 (36.4)	1.55 (39.4)	14.96 (380)	613 (915)	134 (2.4)	572 (260)

ELECTRICAL SPECIFICATIONS

Part Number	Cable Size in (mm)	Conductor DC Resistance Ohms/kft (Ohms/km)		Insulation Resistance mΩ km	Dielectric Strength for 1 minute DC Potential - Volts	Velocity of Propagation %	Peak Power Rating kW	Maximum Operating Frequency GHz	Characteristic Impedance Ohms	Typical Return Loss dB
		Inner	Outer							
LHF-12D	½ (12)	0.5 (1.6)	0.6 (1.9)	10,000	4,000	89	40	8.8	50	28
LHF-33D	1¼ (33)	0.3 (1.1)	0.3 (1.0)	10,000	10,000	89	200	3.3	50 ± 1	28

Frequency MHz	Attenuation at 20°C dB/100 ft (dB/100 m)		Average Power Rating at Ambient 40°C Inner Conductor 100°C kW	
	LHF-12D	LHF-33D	LHF-12D	LHF-33D
30	0.35 (1.14)	0.13 (0.42)	6.10	21.30
100	0.65 (2.12)	0.24 (0.49)	3.32	11.50
150	0.79 (2.60)	0.30 (0.98)	2.71	9.32
450	1.40 (4.58)	0.54 (1.77)	1.55	5.23
824	1.92 (6.31)	0.76 (2.49)	1.13	3.78
894	2.00 (6.55)	0.80 (2.61)	1.09	3.61
960	2.08 (6.84)	0.83 (2.72)	1.05	3.48
1,000	2.13 (7.00)	0.85 (2.79)	1.03	3.40
1,700	2.84 (9.32)	1.17 (3.84)	0.78	2.53
1,800	2.93 (9.61)	1.21 (3.97)	0.76	2.45
2,000	3.11 (10.19)	1.30 (4.25)	0.71	2.31
2,400	3.38 (11.10)	1.44 (4.73)	0.65	2.09
2,700	3.81 (12.53)	1.56 (5.11)	0.61	1.95
3,000	3.95 (12.96)	1.66 (5.43)	0.58	1.84

Frequency MHz	V.S.W.R.	
	LHF-12D	LHF-33D
800-960	1.15	1.15
1,700-2,200	1.15	1.15

Standard Conditions: V.S.W.R. 1.0, Ambient Temperature 20°C/Attenuation is typical value.

LHF (White Jacketed) Series

Low Loss High Flexible Foam Dielectric Feeder

PRODUCT DESCRIPTION

LHF Series cables are low loss 50 Ohm cables featuring a foamed polyethylene dielectric, annularly corrugated copper shield and polyethylene jacket.

FEATURES

- Low attenuation
- Low passive intermodulation
- Easy connectorization
- Factory tested and inspected
- Rugged and durable

BENEFITS

- Suitable for long cable runs
- Outperforms the industry requirements for low passive intermodulation
- Full line of high-quality low intermodulation DIN and N connectors and cable preparation tools minimize installation time and expenses
- 100% of all RF cables are inspected and tested to meet or exceed industry specifications including passive intermodulation
- High-quality materials result in rugged cables that are able to withstand extreme environments without corrosion

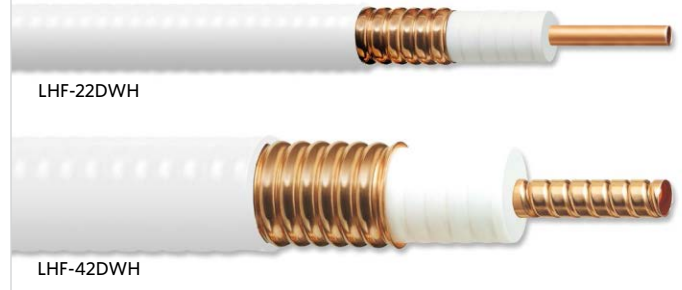

SPECIFICATIONS

Inner Conductor	LHF-22DWH: Smooth copper tube LHF-42DWH: Helically corrugated copper tube
Dielectric	Foamed polyethylene
Outer Conductor	Annularly corrugated copper tube
Jacket	White polyethylene
Recommended Operating Temperature °F (°C)	-40 to +185 (-40 to +80)

PART NUMBERS AND PHYSICAL CHARACTERISTICS

Part Number	Cable Size in (mm)	Nominal Diameter in (mm)				Minimum Bend Radius in (mm)	Approx. Weight lbs/kft (kg/km)	Flat Plate Crush Resistance lbs/in (kg/mm)	Maximum Pulling Force lbs (kg)
		Inner Conductor	Dielectric	Outer Conductor	Jacket				
LHF-22DWH	7/8 (22)	0.37 (9.4)	0.93 (23.5)	1.00 (25.3)	1.10 (28.0)	9.84 (250)	325 (485)	101 (1.8)	323 (147)
LHF-42DWH	1 1/8 (42)	0.71 (18.1)	1.71 (43.5)	1.83 (46.5)	1.97 (50.0)	19.69 (500)	716 (1,068)	90 (1.6)	398 (181)

ELECTRICAL SPECIFICATIONS

Part Number	Cable Size in (mm)	Conductor DC Resistance Ohms/kft (Ohms/km)		Insulation Resistance mΩ km	Dielectric Strength for 1 minute DC Potential - Volts	Velocity of Propagation %	Peak Power Rating kW	Maximum Operating Frequency GHz	Characteristic Impedance Ohms	Typical Return Loss dB
		Inner	Outer							
LHF-22DWH	7/8 (22)	0.5 (1.5)	0.6 (1.9)	10,000	6,000	89	91	4.9	50 ± 1	28
LHF-42DWH	1 1/8 (42)	0.4 (1.4)	0.2 (0.6)	10,000	11,000	89	302	2.5	50 ± 1	28

Frequency MHz	Attenuation at 20°C dB/100 ft (dB/100 m)		Average Power Rating at Ambient 40°C Inner Conductor 100°C kW	
	LHF-22DWH	LHF-42DWH	LHF-22DWH	LHF-42DWH
30	0.18 (0.59)	0.10 (0.33)	13.95	30.60
100	0.34 (1.13)	0.20 (0.64)	7.36	16.42
150	0.43 (1.40)	0.24 (0.80)	5.98	13.28
450	0.77 (2.52)	0.45 (1.48)	3.32	7.37
824	1.07 (3.51)	0.64 (2.11)	2.46	5.28
894	1.12 (3.67)	0.67 (2.20)	2.36	5.05
960	1.16 (3.82)	0.70 (2.31)	2.27	4.85
1,000	1.19 (3.92)	0.73 (2.38)	2.22	4.74
1,700	1.61 (5.29)	1.00 (3.28)	1.67	3.50
1,800	1.67 (5.47)	1.04 (3.40)	1.62	3.39
2,000	1.77 (5.81)	1.11 (3.63)	1.53	3.18
2,400	1.97 (6.46)	1.23 (4.05)	1.38	2.86
2,700	2.10 (6.88)	1.27 (4.18)	1.31	2.77

Frequency MHz	V.S.W.R.	
	LHF-22DWH	LHF-42DWH
800-960	1.15	1.15
1,700-2,200	1.15	1.15

Standard Conditions: V.S.W.R. 1.0.

Ambient Temperature 20°C/Attenuation is typical value.

LHF Series (Ultimate High Performance)

Ultimate Low Loss High Flexible Foam Dielectric Feeder



PRODUCT DESCRIPTION

LHF Ultimate High Performance Series cables are low loss 50 Ohm cables featuring a copper tube center conductor, foamed polyethylene dielectric and annularly corrugated copper metallic shield. Ultimate High Performance cables are designed to offer the low attenuation and high propagation velocity required by modern 3G and 4G networks.

FEATURES

- Low attenuation and high propagation velocity
- Low passive intermodulation
- Easy connectorization
- Factory tested and inspected
- Rugged and durable

BENEFITS

- Highly efficient signal transfer over long cable runs
- Outperforms the industry requirements for low passive intermodulation
- Full line of high-quality low intermodulation DIN and N connectors and cable preparation tools minimize installation time and expenses
- 100% of all RF cables are inspected and tested to meet or exceed industry specifications including passive intermodulation
- High-quality materials result in rugged cables that are able to withstand extreme environments without corrosion

SPECIFICATIONS

Inner Conductor	LHF-22DU: Smooth copper tube LHF-42DU: Corrugated copper tube
Dielectric	Foamed polyethylene
Outer Conductor	Annularly corrugated copper tube
Jacket	Black polyethylene
Recommended Operating Temperature °F (°C)	-40 to +185 (-40 to +80)

PART NUMBERS AND PHYSICAL CHARACTERISTICS

Part Number	Cable Size in (mm)	Nominal Diameter in (mm)				Minimum Bend Radius in (mm)	Approx. Weight lbs/kft (kg/km)	Flat Plate Crush Resistance lbs/in (kg/mm)	Maximum Pulling Force lbs (kg)
		Inner Conductor	Dielectric	Outer Conductor	Jacket				
LHF-22DU	7/8 (22)	0.37 (9.5)	0.91 (23.1)	1.00 (25.3)	1.11 (28.2)	9.84 (250)	316 (470)	100 (1.8)	323 (147)
LHF-42DUF	1 1/8 (42)	0.71 (18.1)	1.72 (43.6)	1.83 (46.6)	1.97 (50.0)	19.69 (500)	710 (1,059)	90 (1.6)	398 (181)

ELECTRICAL SPECIFICATIONS

Part Number	Cable Size in (mm)	Conductor DC Resistance Ohms/kft (Ohms/km)		Insulation Resistance mΩ km	Dielectric Strength for 1 minute DC Potential - Volts	Velocity of Propagation %	Peak Power Rating kW	Maximum Operating Frequency GHz	Characteristic Impedance Ohms	Typical Return Loss dB
		Inner	Outer							
LHF-22DU	7/8 (22)	0.6 (1.9)	0.6 (1.9)	10,000	6,000	91 ± 3	0.92	5.0	50 ± 1	28
LHF-42DUF	1 1/8 (42)	0.4 (1.6)	0.2 (0.7)	10,000	11,000	92 ± 3	2.77	2.5	50 ± 1	28

Frequency MHz	Average Power Rating at Ambient 40°C Inner Conductor 100°C kW			
	Attenuation at 20°C dB/100 ft (dB/100 m)			
	LHF-22D	LHF-42D	LHF-22DU	LHF-42DUF
450	0.73 (2.42)	0.43 (1.43)	-	-
700	0.93 (3.06)	0.55 (1.82)	-	-
824	1.02 (3.35)	0.61 (2.00)	2.49	3.60
894	1.07 (3.50)	0.64 (2.09)	2.38	3.44
960	1.11 (3.64)	0.66 (2.18)	-	-
1,700	1.52 (4.99)	0.92 (3.02)	1.67	2.38
1,800	-	-	1.61	2.30
2,000	1.66 (5.47)	1.01 (3.33)	1.54	2.16
2,400	1.85 (6.07)	1.13 (3.71)	-	-
3,000	2.10 (6.89)	-	-	-

Frequency MHz	V.S.W.R.	
	LHF-22DU	LHF-42DU
800-960	1.13	1.13
1,700-2,200	1.13	1.13

Standard Conditions: V.S.W.R. 1.0,

Ambient Temperature 20°C/Attenuation is typical value.



PRODUCT DESCRIPTION

HFSC Series cables are super flexible lightweight coaxial cables featuring a copper clad aluminum conductor, foamed polyethylene dielectric and corrugated copper metallic shield. This helically corrugated cable has the highest number of corrugations per inch and the lowest minimum bending radius, making it well-suited for jumper cable and installations where bending and tight spaces require a more flexible cable.

FEATURES

- Light weight and flexible
- Low passive intermodulation
- Easy connectorization
- Factory tested and inspected
- Rugged and durable

BENEFITS

- Easy to transport and install
- Outperforms the industry requirements for low passive intermodulation
- Full line of high-quality low intermodulation DIN and N connectors and cable preparation tools minimize installation time and expense
- 100% of all RF cables are inspected and tested to meet or exceed industry specifications including passive intermodulation
- High-quality materials result in rugged cables that are able to withstand extreme environments without corrosion

SPECIFICATIONS

Inner Conductor	Copper-clad aluminum wire
Dielectric	Foamed polyethylene
Outer Conductor	Helically corrugated copper tube
Jacket	Black polyethylene
Recommended Operating Temperature °F (°C)	-40 to +185 (-40 to +80)

PART NUMBERS AND PHYSICAL CHARACTERISTICS

Part Number	Cable Size in (mm)	Nominal Diameter in (mm)				Minimum Bend Radius in (mm)	Approx. Weight lbs/kft (kg/km)	Flat Plate Crush Resistance lbs/in (kg/mm)	Maximum Pulling Force lbs (kg)
		Inner Conductor	Dielectric	Outer Conductor	Jacket				
HFSC-12D	½ (12)	0.14 (3.6)	0.35 (8.9)	0.48 (12.2)	0.54 (13.6)	1.26 (32)	135 (201)	95g (1.7)	143 (65)

ELECTRICAL SPECIFICATIONS

Part Number	Cable Size in (mm)	Conductor DC Resistance Ohms/kft (Ohms/km)		Insulation Resistance mΩ km	Dielectric Strength for 1 minute DC Potential - Volts	Velocity of Propagation %	Peak Power Rating kW	Maximum Operating Frequency GHz	Characteristic Impedance Ohms	Typical Return Loss dB
		Inner	Outer							
HFSC-12D	½ (12)	0.87 (2.85)	0.99 (3.25)	10,000	2,500	81	15.6	10.0	50	28

Frequency MHz	Attenuation at 20°C dB/100 ft (dB/100 m)	Average Power Rating at Ambient 40°C Inner Conductor 100°C kW	
		Inner	Outer
30	0.55 (1.80)		4.87
100	1.01 (3.33)		2.62
150	1.25 (4.10)		2.12
450	2.22 (7.29)		1.19
824	3.08 (10.10)		0.85
894	3.20 (10.50)		0.82
960	3.35 (11.00)		0.79
1,000	3.41 (11.20)		0.77
1,700	4.57 (15.00)		0.57
1,800	4.72 (15.50)		0.55
2,000	5.00 (16.40)		0.52
2,400	5.55 (18.20)		0.47
3,000	6.31 (20.70)		0.41
4,000	7.44 (24.40)		0.35
6,000	9.45 (31.00)		0.27
10,000	12.89 (42.30)		0.20

Frequency MHz	V.S.W.R.
800-960	1.15
1,700-2,200	1.15

Standard Conditions: V.S.W.R. 1.0, Ambient Temperature 20°C/Attenuation is typical value.

Fiber-to-the-Antenna (FTTA)

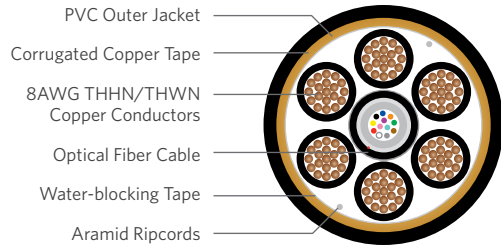

PRODUCT DESCRIPTION

Fiber-to-the-Antenna (FTFA) cables are designed to address the movement of electronics from the ground hut to the cell tower, allowing significant improvement in available bandwidth. Superior Essex offers two types of cable for this application: optical fiber and hybrid (containing both optical fibers and copper power conductors). Optical fiber cables are available with PFM™ gel; hybrid cables are available with either PFM gel components or tight buffered components. Each of the options provide a solution to the challenges of temperature changes, wind shear and vertical applications. The hybrid offering also has a copper shield option for lightning protection and a PVC jacket to increase the coefficient friction between the outer jacket and tower clamps.

APPLICATIONS

- Fiber-to-the-Antenna
- Fiber-to-the-Remote Radio Head

FEATURES

- PFM gel or tight buffer
- Hybrid designs
- Shield options
- Jacketing options
- Range of fibers
- Optional signaling component available

BENEFITS

- Proven performance in tower applications
- Reduces required number of cables
- Customer preference for lightning protection
- Customer preference for jacketing material
- Addresses multiple provider/capacity requirements
- Offers system feedback

FIBER COMPONENT SPECIFICATIONS

Tight Buffer	Tight Buffered Low Smoke Zero Halogen (LSZH), Riser Available in 2-fiber up to 12-fiber
Loose Tube	Stranded Loose Tube Indoor/Outdoor OFNR, Series 13 Available in 12-fiber up to 288-fiber
Central Tube	Single Loose Tube Indoor/Outdoor OFNR, Series 53 Available in 2-fiber up to 96-fiber
Performance Compliance	Telcordia GR-20-CORE

POWER COMPONENT SPECIFICATIONS

Conductor	Annealed stranded copper (19 strands)
AWG	Available in 8 AWG
Insulation	Polyvinyl Chloride (PVC) covered with colored Nylon (THHN/THWN-2)
Temperature Ratings	Rated at 90°C for dry locations Rated at 75°C for wet locations
Performance Compliance	ASTM B8 or ASTM B-787 UL 83
Other Compliance	Sunlight Resistant RoHS-compliant

ENVIRONMENTAL SPECIFICATIONS

Operation/Storage	-40°C to +70°C
Installation	-10°C to +65°C

PART NUMBERS AND PHYSICAL CHARACTERISTICS

Part Number	Conductor Count	AWG (mm)	Fiber Component	Fiber Count	Nominal Diameter in (mm)	Approx. Weight lbs/kft (kg/km)	Maximum Tensile Load		Minimum Bend Radius	
							Install lbs (N)	Long Term lbs (N)	Install in (mm)	Long Term in (mm)
53012K01Q	-	-	Central tube	12	0.37 (9.5)	52 (78)	600 (2,700)	200 (890)	7.4 (188)	3.7 (94)
53024K01Q	-	-	Central tube	24	0.37 (9.5)	53 (79)	600 (2,700)	200 (890)	7.4 (188)	3.7 (94)
53048J01Q	-	-	Central tube	48	0.37 (9.5)	54 (80)	600 (2,700)	200 (890)	7.4 (188)	3.7 (94)
GM012K221	6	8 (3.26)	Tight buffer	12	0.86 (21.8)	568 (847)	600 (2,700)	200 (890)	17.2 (236)	8.6 (218)
GM012K111	6	8 (3.26)	Central tube	12	0.87 (22.0)	568 (847)	600 (2,700)	200 (890)	17.4 (440)	8.7 (220)
GM012K011	6	8 (3.26)	Loose tube	12	0.95 (24.1)	614 (915)	600 (2,700)	200 (890)	19.0 (482)	9.5 (241)

Part numbers listed are TeraFlex Bend Resistant single mode optical fiber only. Other fiber types available. See "Optical Fiber Specifications" in the "Technical Information" section for detailed fiber type specifications.

PRODUCT DESCRIPTION

Jumper cables offer outstanding electrical performance along with high durability for tight routing and superior environmental sealing for long life reliability.

Available in 3/8 inch and 1/2 inch diameters, jumper cables are used in areas that require extremely small bending radius, such as between main feeders and antennas or between main feeders and RF equipment.

FEATURES/BENEFITS

- High pull-off strength
- Excellent V.S.W.R. performance
- Low and stable intermodulation
- Weatherproof



SPECIFICATIONS

Compatible Cable Type	HFSC-12D
Compatible Cable Size in (mm)	1/2 (12)
Minimum Bend Radius in (mm)	1.26 (32)
Typical V.S.W.R.	1.08 over Cellular, PCS and 3G-band
Intermodulation (PIM) dBc	< -158
Recommended Operating Temperature °F (°C)	-40 to +185 (-40 to +80)

PART NUMBERS AND PHYSICAL CHARACTERISTICS

Part Number	Interface Type		Standard Length ft (m)	Unit of Measure
	End 1	End 2		
J12-1DMDM	DIN Male, Straight	DIN Male, Straight	3.3 (1)	Each
J12-1NMNM	N Male, Straight	N Male, Straight	3.3 (1)	Each
J12-2DMDM	DIN Male, Straight	DIN Male, Straight	6.6 (2)	Each
J12-2NMNM	N Male, Straight	N Male, Straight	6.6 (2)	Each
J12-3DMDM	DIN Male, Straight	DIN Male, Straight	9.8 (3)	Each
J12-3NMNM	N Male, Straight	N Male, Straight	9.8 (3)	Each
J12-3NMNMR	N Male, Straight	N Male, Right Angle	9.8 (3)	Each
J12-4DMDM	DIN Male, Straight	DIN Male, Straight	13.1 (4)	Each
J12-4NMNM	N Male, Straight	N Male, Straight	13.1 (4)	Each
J12-5DMDM	DIN Male, Straight	DIN Male, Straight	16.4 (5)	Each
J12-5DMDMDF	DIN Male, Straight	DIN Female, Straight	16.4 (5)	Each
J12-5NMNM	N Male, Straight	N Male, Straight	16.4 (5)	Each
J12-6NMNMR	N Male, Straight	N Male, Right Angle	19.7 (6)	Each

EXPLANATION OF PART NUMBERS

J12-2DMDMR

Product Category	Compatible Cable Size	Jumper Length	Connector for End 1	Connector for End 2
J = Jumper Cable	12 = 1/2 inch (12 mm)	1 = 1 meter 2 = 2 meters 3 = 3 meters 4 = 4 meters 5 = 5 meters 6 = 6 meters	DM = DIN Male straight DMR = DIN Male Right angle DF = DIN Female straight DFR = DIN Female Right angle NM = N Male straight NMR = N Male Right angle NF = N Female NFR = N Female Right angle	DM = DIN Male straight DMR = DIN Male Right angle DF = DIN Female straight DFR = DIN Female Right angle NM = N Male straight NMR = N Male Right angle NF = N Female NFR = N Female Right angle

DIN Series for LHF



½ inch (12 mm)



¾ inch (22 mm)



1¼ inch (33 mm)



1 inch (42 mm)

SPECIFICATIONS

Bodies, Cap (Coupling Nut) Material	Brass/silver plated or Su Co (Alloy of Cu/Sn/Zn) plated
Back Nut Material	Brass/nickel plated
Pin Material	Male: Brass/silver plated or Su Co (Alloy of Cu/Sn/Zn) plated Female: Beryllium - copper/silver plated or Su Co (Alloy of Cu/Sn/Zn) plated
Insulator Material	Plated PTFE (Teflon®)
Gasket Material	Silicon rubber
Recommended Coupling Nut Torque Nm	25-30
Coupling Nut Retention Force Nm	1,000
Contact Captivation N	200
Mating Durability	500 times

PRODUCT DESCRIPTION

This DIN Series is compatible with the LHF Feeder Series. The connectors are manufactured from an alloy material of copper, tin and zinc to produce a highly polished, precise, and strong connector. This alloy combination allows a better operating temperature range and improved environmental performance.

FEATURES/BENEFITS

- Two-piece design is the industry standard
- Simple 6-step user friendly installation process
- Ordinary tools needed; available in a common installers tool bag
- Connector can be disassembled and re-used
- Offers stable connections

ELECTRICAL SPECIFICATIONS

Impedance Ω	50
Maximum Frequency Range GHz	7.5
V.S.W.R. (Mating) straight (right angle)	1 GHz: 1.08 (1.12) 2 GHz: 1.10 (1.15)
Maximum Insertion Loss dB @ 3 GHz	0.2
Intermodulation (PIM) dBc	< -155
Dielectric Withstanding Voltage kV rms @ 50 Hz	4.0
Working Voltage kV rms @ 50 Hz	2.7
Insulation Resistance GΩ	10
Contact Resistance mΩ	Inner: 0.4 Outer: 1.5

ENVIRONMENTAL SPECIFICATIONS

Temperature Range °F (°C)	-85 to +329 (-65 to +165)
Corrosion (Salt Spray Test)	IEC-68-2-11-Ka
Vibration	CECC 22000 Part 4.6.3
Waterproof	IP68

PART NUMBERS AND PHYSICAL CHARACTERISTICS

Part Number	DIN Interface Type		Compatible Cable Size in (mm)	Length in (mm)	Diameter in (mm)	Weight oz (g)
	Gender	Straight or Angle				
CLH-12DF	Female	Straight	½ (12)	2.65 (67.4)	0.86 (21.8)	5.3 (150)
CLH-12DFR	Female	Right Angle	½ (12)	-	-	-
CLH-12DM	Male	Straight	½ (12)	2.57 (65.4)	0.86 (21.8)	6.5 (183)
CLH-12DMR	Male	Right Angle	½ (12)	-	-	-
CLH-22DF	Female	Straight	¾ (22)	2.62 (66.5)	1.39 (35.2)	7.4 (210)
CLH-22DM	Male	Straight	¾ (22)	2.81 (71.5)	1.39 (35.2)	8.1 (230)
CLH-33DF	Female	Straight	1¼ (33)	3.50 (88.9)	1.87 (47.6)	19.8 (560)
CLH-33DM	Male	Straight	1¼ (33)	3.76 (95.4)	1.87 (47.6)	19.8 (560)
CLH-42DF	Female	Straight	1 inch (42)	3.92 (99.5)	2.35 (59.6)	35.3 (1,000)
CLH-42DM	Male	Straight	1 inch (42)	4.21 (107.0)	2.35 (59.6)	37.7 (1,070)



TECHNICAL GUIDELINE

Installation guidelines are available for these connectors. Refer to the "Resources" section on our site for the Technical Guideline, "DIN Connectors and N Connectors Installation Guidelines," for more information.

DIN Series for HFSC

PRODUCT DESCRIPTION

This DIN Series is compatible with the HFSC Feeder Series. The connectors are manufactured from an alloy material of copper, tin and zinc to produce a highly polished, precise, and strong connector. This alloy combination allows a better operating temperature range and improved environmental performance.

FEATURES/BENEFITS

- Two-piece design is the industry standard
- Simple 6-step user friendly installation process
- Ordinary tools needed; available in a common installers tool bag
- Connector can be disassembled and re-used
- Offers stable connections



½ inch (12 mm)

SPECIFICATIONS

Bodies, Cap (Coupling Nut) Material	Brass/silver plated or Su Co (Alloy of Cu/Sn/Zn) plated
Back Nut Material	Brass/nickel plated
Pin Material	Male: Brass/silver plated or Su Co (Alloy of Cu/Sn/Zn) plated Female: Beryllium - copper/silver plated or Su Co (Alloy of Cu/Sn/Zn) plated
Insulator Material	Plated PTFE (Teflon®)
Gasket Material	Silicon rubber
Recommended Coupling Nut Torque Nm	25-30
Coupling Nut Retention Force Nm	1,000
Contact Captivation N	200
Mating Durability	500 times

ELECTRICAL SPECIFICATIONS

Impedance Ω	50
Maximum Frequency Range GHz	7.5
V.S.W.R. (Mating) straight (right angle)	1 GHz: 1.08 (1.12) 2 GHz: 1.10 (1.15)
Maximum Insertion Loss dB @ 3 GHz	0.2
Intermodulation (PIM) dBc	< -155
Dielectric Withstanding Voltage kV rms @ 50 Hz	4.0
Working Voltage kV rms @ 50 Hz	2.7
Insulation Resistance GΩ	10
Contact Resistance mΩ	Inner: 0.4 Outer: 1.5

ENVIRONMENTAL SPECIFICATIONS

Temperature Range °F (°C)	-85 to +329 (-65 to +165)
Corrosion (Salt Spray Test)	IEC-68-2-11-Ka
Vibration	CECC 22000 Part 4.6.3
Waterproof	IP68

PART NUMBERS AND PHYSICAL CHARACTERISTICS

Part Number	DIN Interface Type		Compatible Cable Size in (mm)	Length in (mm)	Diameter in (mm)	Weight oz (g)
	Gender	Straight or Angle				
CHFS-12DF	Female	Straight	½ (12)	2.65 (67.4)	0.86 (21.8)	5.3 (150)
CHFS12DFR	Female	Right Angle	½ (12)	-	-	-
CHFS-12DM	Male	Straight	½ (12)	2.57 (65.4)	0.86 (21.8)	6.5 (183)
CHFS12DMR	Male	Right Angle	½ (12)	-	-	-



TECHNICAL GUIDELINE

Installation guidelines are available for these connectors. Refer to the "Resources" section on our site for the Technical Guideline, "DIN Connectors and N Connectors Installation Guidelines," for more information.

N Series for LHF



½ inch (12 mm)



¾ inch (22 mm)



1¼ inch (33 mm)



1½ inch (42 mm)

SPECIFICATIONS

Bodies, Cap (Coupling Nut) Material	Brass/silver plated or Su Co (Alloy of Cu/Sn/Zn) plated
Back Nut Material	Brass/nickel plated
Pin Material	Male: Brass/silver plated or Su Co (Alloy of Cu/Sn/Zn) plated Female: Beryllium - copper/silver plated or Su Co (Alloy of Cu/Sn/Zn) plated
Insulator Material	Plated PTFE (Teflon®)
Gasket Material	Silicon rubber
Recommended Coupling Nut Torque Nm	25-30
Coupling Nut Retention Force Nm	1,000
Contact Captivation N	200
Mating Durability	500 times

PRODUCT DESCRIPTION

This N Series is compatible with the LHF Feeder Series. The connectors are manufactured from an alloy material of copper, tin and zinc to produce a highly polished, precise, and strong connector. This alloy combination allows a better operating temperature range and improved environmental performance.

FEATURES/BENEFITS

- Two-piece design is the industry standard
- Simple 6-step user friendly installation process
- Ordinary tools needed; available in a common installers tool bag
- Connector can be disassembled and re-used
- Offers stable connections

ELECTRICAL SPECIFICATIONS

Impedance Ω	50
Maximum Frequency Range GHz	7.5
V.S.W.R. (Mating) straight (right angle)	1 GHz: 1.08 (1.12) 2 GHz: 1.10 (1.15)
Maximum Insertion Loss dB @ 3 GHz	0.2
Intermodulation (PIM) dBc	< -155
Dielectric Withstanding Voltage kV rms @ 50 Hz	4.0
Working Voltage kV rms @ 50 Hz	2.7
Insulation Resistance GΩ	10
Contact Resistance mΩ	Inner: 0.4 Outer: 1.5

ENVIRONMENTAL SPECIFICATIONS

Temperature Range °F (°C)	-85 to +329 (-65 to +165)
Corrosion (Salt Spray Test)	IEC-68-2-11-Ka
Vibration	CECC 22000 Part 4.6.3
Waterproof	IP68

PART NUMBERS AND PHYSICAL CHARACTERISTICS

Part Number	N Interface Type		Compatible Cable Size in (mm)	Length in (mm)	Diameter in (mm)	Weight oz (g)
	Gender	Straight or Angle				
CLH-12NF	Female	Straight	½ (12)	2.75 (69.8)	0.86 (21.8)	4.1 (115)
CLH-12NFR	Female	Right Angle	½ (12)	-	-	-
CLH-12NM	Male	Straight	½ (12)	2.75 (69.8)	0.86 (21.8)	4.2 (120)
CLH-12NMR	Male	Right Angle	½ (12)	-	-	-
CLH-22NF	Female	Straight	¾ (22)	2.75 (69.9)	1.39 (35.2)	7.6 (215)
CLH-22NM	Male	Straight	¾ (22)	2.86 (72.7)	1.39 (35.2)	7.6 (215)
CLH-33NF	Female	Straight	1¼ (33)	3.76 (95.5)	1.87 (47.6)	19.8 (560)
CLH-33NM	Male	Straight	1¼ (33)	3.86 (98.0)	1.87 (47.6)	19.8 (560)
CLH-42NF	Female	Straight	1½ (42)	41.3 (105.0)	2.35 (59.6)	35.3 (1,000)
CLH-42NM	Male	Straight	1½ (42)	4.25 (108.0)	2.35 (59.6)	37.7 (1,070)



TECHNICAL GUIDELINE

Installation guidelines are available for these connectors. Refer to the "Resources" section on our site for the Technical Guideline, "DIN Connectors and N Connectors Installation Guidelines," for more information.

N Series for HFSC

PRODUCT DESCRIPTION

This N Series is compatible with the HFSC Feeder Series. The connectors are manufactured from an alloy material of copper, tin and zinc to produce a highly polished, precise, and strong connector. This alloy combination allows a better operating temperature range and improved environmental performance.

FEATURES/BENEFITS

- Two-piece design is the industry standard
- Simple 6-step user friendly installation process
- Ordinary tools needed; available in a common installers tool bag
- Connector can be disassembled and re-used
- Offers stable connections



½ inch (12 mm)

SPECIFICATIONS

Bodies, Cap (Coupling Nut) Material	Brass/silver plated or Su Co (Alloy of Cu/Sn/Zn) plated
Back Nut Material	Brass/nickel plated
Pin Material	Male: Brass/silver plated or Su Co (Alloy of Cu/Sn/Zn) plated Female: Beryllium - copper/silver plated or Su Co (Alloy of Cu/Sn/Zn) plated
Insulator Material	Plated PTFE (Teflon®)
Gasket Material	Silicon rubber
Recommended Coupling Nut Torque Nm	25-30
Coupling Nut Retention Force Nm	1,000
Contact Captivation N	200
Mating Durability	500 times

ELECTRICAL SPECIFICATIONS

Impedance Ω	50
Maximum Frequency Range GHz	7.5
V.S.W.R. (Mating) straight (right angle)	1 GHz: 1.08 (1.12) 2 GHz: 1.10 (1.15)
Maximum Insertion Loss dB @ 3 GHz	0.2
Intermodulation (PIM) dBc	< -155
Dielectric Withstanding Voltage kV rms @ 50 Hz	4.0
Working Voltage kV rms @ 50 Hz	2.7
Insulation Resistance GΩ	10
Contact Resistance mΩ	Inner: 0.4 Outer: 1.5

ENVIRONMENTAL SPECIFICATIONS

Temperature Range °F (°C)	-85 to +329 (-65 to +165)
Corrosion (Salt Spray Test)	IEC-68-2-11-Ka
Vibration	CECC 22000 Part 4.6.3
Waterproof	IP68

PART NUMBERS AND PHYSICAL CHARACTERISTICS

Part Number	N Interface Type		Compatible Cable Size in (mm)	Length in (mm)	Diameter in (mm)	Weight oz (g)
	Gender	Straight or Angle				
CHFS-12NF	Female	Straight	½ (12)	2.75 (69.8)	0.86 (21.8)	4.1 (115)
CHFS12NFR	Female	Right Angle	½ (12)	-	-	-
CHFS-12NM	Male	Straight	½ (12)	2.75 (69.8)	0.86 (21.8)	4.2 (120)
CHFS12NMR	Male	Right Angle	½ (12)	-	-	-



TECHNICAL GUIDELINE

Installation guidelines are available for these connectors. Refer to the "Resources" section on our site for the Technical Guideline, "DIN Connectors and N Connectors Installation Guidelines," for more information.

DAS Hybrid

Fiber + Copper

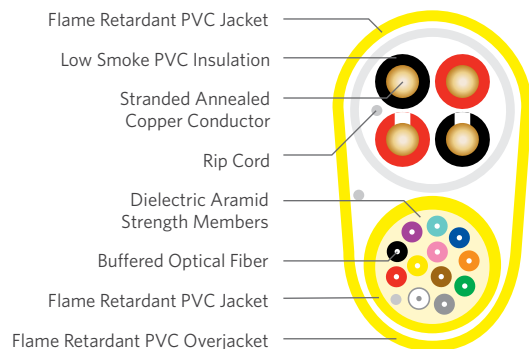

PRODUCT DESCRIPTION

A jacketed multi-strand optical fiber cable and a jacketed multi-conductor copper cable are covered with an overjacket to form a single hybrid cable. The optical fiber cable contains 12 flexible 900 μm tight buffered single mode fibers for voice and data communications. The non-shielded copper cable contains four 12 AWG conductors ideal for carrying power, control signals and video.

Hybrid cables are intended for applications that utilize centralized DC power and comply with NEC Article 725 for Class 2 power limited circuits. A hybrid cable reduces installation time and labor by allowing both fiber and copper cables to be pulled as a single cable, eliminating the need for two separate pulls. Labor costs are further minimized because the cable can be pulled by a telecom installer instead of an electrician.

APPLICATIONS

- Distributed Antenna Systems (DAS)
- CCTV
- Wi-Fi

FEATURES

- Two cables covered with an overjacket to form a single cable
- Overjacket design plus rip cord
- NEC Class 2 power limited circuit
- UL 13 CL2P plenum rated
- 900 μm tight buffered
- Large 12 AWG copper wires
- QuickCount® marking system in feet and meters

BENEFITS

- One pull eliminates the time and labor cost for a second pull
- Easy to separate and route fiber and copper to different termination points
- Installation doesn't have to be done by an electrician
- Cable can be installed throughout a building, including air carrying plenum space, without being enclosed in a raceway
- Easy connectorization in the field
- For long cable runs
- Provides remaining length of cable on reel, resulting in less scrap

COPPER COMPONENT SPECIFICATIONS

Configuration	Stranded bare copper with uniquely colored insulation, jacketed, non-shielded
Conductor Count	4 conductors
Conductor	Fully annealed, stranded bare copper
Conductor Type	19 x 0.185"
AWG (mm)	12 (2.05)
Insulation	Low smoke PVC
Insulation Colors	Conductor 1: Black Conductor 2: Red Conductor 3: Black with white stripe Conductor 4: Red with white stripe
Jacket	White, Flame Retardant (FR) PVC
Performance Compliance	NEC Article 725 NEC Article 800 NFPA 262
NRTL Programs	UL Listed CL3P

OPTICAL FIBER COMPONENT SPECIFICATIONS

Configuration	Flexible 900 μm tight buffered fibers, dielectric aramid yarns and overall jacket
Fiber Count	12
Fiber Type	Single mode TeraFlex® Bend Resistant G.657.A1
Maximum Tensile Loading lbs (N)	Install: 100 (400) Long Term: 30 (130)
Jacket	Yellow, FR PVC
Performance Compliance	UL 1651 CSA C22.2 No. 232 NFPA 262 Telcordia GR-409-CORE, Issue 2 ANSI/ICEA S-83-596 ANSI/TIA-568-C.3
NRTL Programs	UL, c(UL) Listed OFNP

COMPOSITE SPECIFICATIONS

Jacket	Yellow, FR PVC
Performance Compliance	NEC Article 725 ANSI/ICEA S-83-596 RoHS-compliant (RoHS 2 Directive 2011/65/EU)
NRTL Programs	UL Listed CL2P

ENVIRONMENTAL SPECIFICATIONS

Storage/Shipping	-40°C to +65°C
Operation	0°C to +75°C

PART NUMBERS AND PHYSICAL CHARACTERISTICS

Part Number	Copper Component Nominal Diameter in (mm)	Fiber Component Nominal Diameter in (mm)	Overall Nominal Diameter in (mm)		Approx. Weight lbs/kft	Maximum Tensile Loading		Minimum Bend Radius	
			Minor in (mm)	Major in (mm)		Install lbs	Long Term lbs	Install in (mm)	Long Term in (mm)
F4C2-012U13-6991-CE5	0.29 (7.31)	0.24 (6.2)	0.38 (9.66)	0.62 (15.76)	160	150	45	7.6 (193)	3.8 (96)

DAS Hybrid, Interlock Armored

Fiber + Copper

PRODUCT DESCRIPTION

A jacketed multi-strand optical fiber cable and a jacketed multi-conductor copper cable are covered with an overjacket to form a single hybrid cable. The optical fiber cable contains 12 flexible 900 μm tight buffered single mode fibers for voice and data communications. The non-shielded copper cable contains four 12 AWG conductors ideal for carrying power, control signals and video.

Hybrid cables are intended for applications that utilize centralized DC power and comply with NEC Article 725 for Class 2 power limited circuits. A hybrid cable reduces installation time and labor by allowing both fiber and copper cables to be pulled as a single cable, eliminating the need for two separate pulls. Labor costs are further minimized because the cable can be pulled by a telecom installer instead of an electrician.

APPLICATIONS

- Distributed Antenna Systems (DAS)
- CCTV
- Wi-Fi

FEATURES

- Two cables covered with an overjacket to form a single cable
- Overjacket design plus rip cord
- NEC Class 2 power limited circuit
- UL 13 CL2P plenum rated
- 900 μm tight buffered
- Large 12 AWG copper wires
- QuickCount® marking system in feet and meters

BENEFITS

- One pull eliminates the time and labor cost for a second pull
- Easy to separate and route fiber and copper to different termination points
- Installation doesn't have to be done by an electrician
- Cable can be installed throughout a building, including air carrying plenum space, without being enclosed in a raceway
- Easy connectorization in the field
- For long cable runs
- Provides remaining length of cable on reel, resulting in less scrap

COMPOSITE SPECIFICATIONS

Jacket	Yellow, FR PVC
Armor	Flexible heavy duty interlocking aluminum tape helically applied over the jacketed fiber and copper cables
Performance Compliance	NEC Article 725 ANSI/ICEA S-83-596 RoHS-compliant (RoHS 2 Directive 2011/65/EU)
NRTL Programs	UL Listed CL2P

ENVIRONMENTAL SPECIFICATIONS

Storage/Shipping	-40°C to +70°C
Operation	0°C to +70°C
Installation	0°C to +60°C

PART NUMBERS AND PHYSICAL CHARACTERISTICS

Part Number	Copper Component Nominal Diameter in (mm)	Fiber Component Nominal Diameter in (mm)	Overall Nominal Diameter in (mm)	Approx. Weight lbs/kft	Maximum Tensile Loading		Minimum Bend Radius	
					Install lbs	Long Term lbs	Install in (mm)	Long Term in (mm)
F2C2-012U13-6991-CE5	0.29 (7.31)	0.24 (6.2)	0.87 (22.0)	315	150	45	17.3 (440)	8.7 (220)

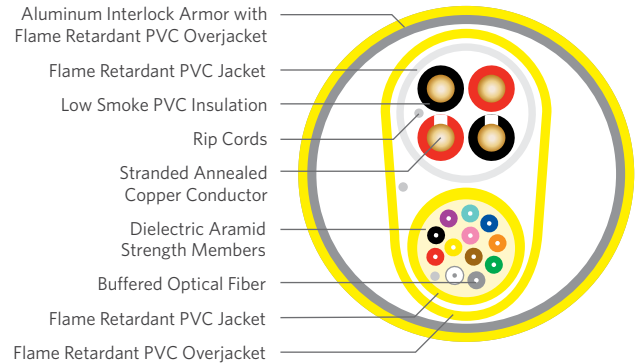

COPPER COMPONENT SPECIFICATIONS

Configuration	Stranded bare copper with uniquely colored insulation, jacketed, non-shielded
Conductor Count	4 conductors
Conductor	Fully annealed, stranded bare copper
Conductor Type	19 x 0.185"
AWG (mm)	12 (2.05)
Insulation	Low smoke PVC
Insulation Colors	Conductor 1: Black Conductor 2: Red Conductor 3: Black with white stripe Conductor 4: Red with white stripe
Jacket	White, Flame Retardant (FR) PVC
Performance Compliance	NEC Article 725 NEC Article 800 NFPA 262
NRTL Programs	UL Listed CL3P

OPTICAL FIBER COMPONENT SPECIFICATIONS

Configuration	Flexible 900 μm tight buffered fibers, dielectric aramid yarns and overall jacket
Fiber Count	12
Fiber Type	Single mode TeraFlex® Bend Resistant G.657.A1
Maximum Tensile Loading lbs (N)	Install: 100 (400) Long Term: 30 (130)
Jacket	Yellow, FR PVC
Performance Compliance	UL 1651 CSA C22.2 No. 232 NFPA 262 Telcordia GR-409-CORE, Issue 2 ANSI/ICEA S-83-596 ANSI/TIA-568-C.3
NRTL Programs	UL, c(UL) Listed OFNP

LHF Riser

Low Loss High Flexible Foam Dielectric Feeder

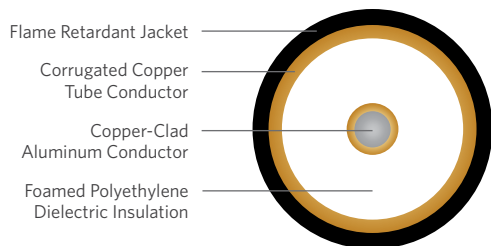

PRODUCT DESCRIPTION

LHF-12DR is a ½ inch, 50 Ohm Riser Rated RF coaxial cable that enables mobile communications inside buildings. Installed to eliminate dead zones and spotty coverage, this cable functions as the backbone cable of in-building DAS wireless systems. With its riser (CMR) rating, this coaxial cable offers flexibility and high crush resistance in a ½ inch size. Designed for high performance, its copper clad aluminum inner conductor, foamed PE dielectric insulation, corrugated copper outer conductor, and its black outer riser rated jacket exceed the requirements of all in-building DAS active systems.

APPLICATIONS

- In-building Wireless
- Distributed Antenna System (DAS)

FEATURES

- Lowest attenuation
- Low passive intermodulation
- Non-halogenated, fire retardant, black polyethylene jacket
- ETL Certified CMR (UL 1666)/CATVR (UL 1581)
- Full range of easy to install connectors and an automated cable prep tool

BENEFITS

- Highly efficient signal transfer
- Outperforms the industry requirements for low PIM
- Rugged and durable jacket slows the spread of flame without releasing toxic smoke
- Suitable for vertical cable runs in a shaft or that penetrate more than one floor within a building
- Shortens installation time and expenses

RELATED PRODUCTS

- Connectors CLH-12xx
- Cable prep tool T-LHF12DR

SPECIFICATIONS

Inner Conductor Material	Copper-clad aluminum
Dielectric Material	Foamed polyethylene
Outer Conductor Material	Corrugated copper tube
Jacket Material	Black, flame retardant PE
Recommended Operating Temperature °F (°C)	-22 to +167 (-30 to +75)

PART NUMBERS AND PHYSICAL CHARACTERISTICS

Part Number	Cable Size in (mm)	Nominal Diameter in (mm)				Minimum Bend Radius in (mm)	Approx. Weight lbs/kft (kg/km)	Flat Plate Crush Resistance lbs/in (kg/mm)	Maximum Pulling Force lbs (kg)
		Inner Conductor	Dielectric	Outer Conductor	Jacket				
LHF-12DR	½ (12)	0.19 (5.0)	0.49 (12.5)	0.55 (14.1)	0.64 (16.3)	4.90 (125)	165 (256)	112 (2.0)	249 (113)

ELECTRICAL SPECIFICATIONS

Part Number	Cable Size in (mm)	Conductor DC Resistance Ohms/kft (Ohms/km)		Minimum Insulation Resistance mΩ km	Dielectric Strength for 1 minute DC Potential - Volts	Velocity of Propagation %	Peak Power Rating kW	Maximum Operating Frequency GHz	Characteristic Impedance Ohms	Typical Return Loss dB
		Inner	Outer							
LHF-12DR	½ (12)	0.50 (1.6)	0.85 (2.8)	10,000	4,000	89	40	8.8	50 ± 1	23

Frequency MHz	Nominal Attenuation* dB/100 ft (dB/100 m)	Average Power Rating at Ambient 40°C Inner Conductor 100°C kW
30	0.35 (1.14)	6.10
100	0.65 (2.12)	3.32
150	0.79 (2.60)	2.71
450	1.40 (4.58)	1.55
824	1.92 (6.31)	1.13
890	2.00 (6.55)	1.09
960	2.08 (6.84)	1.05
1,000	2.13 (7.00)	1.03
1,700	2.84 (9.32)	0.78
1,800	2.93 (9.61)	0.76
2,000	3.11 (10.19)	0.71
2,400	3.38 (11.10)	0.65
3,000	3.95 (12.96)	0.58
4,000	-	0.50

Frequency MHz	V.S.W.R.
806-960	≤ 1.15
1,700-2,155	≤ 1.15

*The attenuation may rise by 0.2%/°C with rising temperature. Maximum attenuation shall not exceed 105% of nominal value. Standard Conditions: V.S.W.R. 1.0, Ambient Temperature 20°C/Attenuation is typical value.

LHF Plenum

Low Loss High Flexible Air Dielectric Feeder

PRODUCT DESCRIPTION

LHF-12DP is a ½ inch, low loss 50 Ohm Plenum Rated RF coaxial cable that is installed in the plenum space of a building as part of an in-building DAS system to eliminate dead zones and spotty coverage. Designed with a copper clad aluminum center conductor, air dielectric center structure, helically corrugated copper tube outer conductor, and Plenum Rated outer jacket, the LHF-12DP is a high performing cable with low loss attenuation.

APPLICATIONS

- In-building Wireless
- Distributed Antenna System (DAS)

FEATURES

- Lowest attenuation
- Low passive intermodulation
- High-quality, white PVDF jacket
- ETL Certified CMP (UL 444)
- Full range of easy to install connectors and an automated cable prep tool

BENEFITS

- Highly efficient signal transfer
- Outperforms the industry requirements for low PIM
- Flame retardant and low smoke; blends with background for optimal building aesthetics
- Safe to use throughout a building, including air carrying plenum space
- Shortens installation time and expenses

RELATED PRODUCTS

- Connectors CLHP-12xx
- Cable prep tool T-LHFA12DP

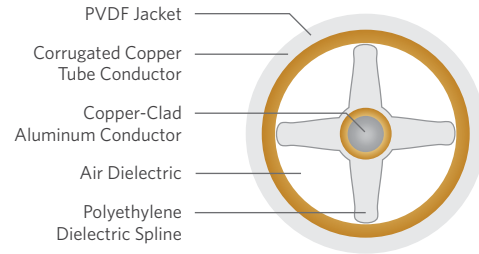

SPECIFICATIONS

Inner Conductor Material	Copper-clad aluminum
Dielectric Material	Polyethylene
Outer Conductor Material	Corrugated copper tube
Jacket Material	White, PVDF
Recommended Operating Temperature °F (°C)	-4 to +167 (-20 to +75)

PART NUMBERS AND PHYSICAL CHARACTERISTICS

Part Number	Cable Size in (mm)	Nominal Diameter in (mm)				Minimum Bend Radius in (mm)	Approx. Weight lbs/kft (kg/km)	Flat Plate Crush Resistance lbs/in (kg/mm)	Maximum Pulling Force lbs (kg)
		Inner Conductor	Dielectric	Outer Conductor	Jacket				
LHF-12DP	½ (12)	0.19 (4.8)	0.47 (12.0)	0.54 (13.8)	0.58 (14.8)	5.91 (150)	139 (207)	58 (1.05)	249 (113)

ELECTRICAL SPECIFICATIONS

Part Number	Cable Size in (mm)	Conductor DC Resistance Ohms/kft (Ohms/km)		Minimum Insulation Resistance mΩ km	Dielectric Strength for 1 minute DC Potential - Volts	Velocity of Propagation %	Peak Power Rating kW	Maximum Operating Frequency GHz	Characteristic Impedance Ohms	Typical Return Loss dB
		Inner	Outer							
LHF-12DP	½ (12)	0.50 (1.6)	0.85 (2.8)	10,000	4,000	88	40	8.8	50 ± 2	19

Frequency MHz	Nominal Attenuation* dB/100 ft (dB/100 m)	Average Power Rating at Ambient 40 °C Inner Conductor 100 °C kW
30	0.35 (1.15)	4.70
100	0.65 (2.14)	2.54
150	0.80 (2.64)	2.06
450	1.43 (4.68)	1.15
824	1.97 (6.46)	0.83
890	2.05 (6.73)	0.80
960	2.14 (7.02)	0.77
1,000	2.18 (7.17)	0.75
1,700	2.92 (9.58)	0.56
1,800	3.01 (9.89)	0.54
2,000	3.19 (10.48)	0.51
2,400	3.53 (11.60)	0.46
3,000	4.07 (13.37)	0.40

Frequency MHz	V.S.W.R.
806-960	≤ 1.25
1,700-2,155	≤ 1.25

*The attenuation may rise by 0.2%/°C with rising temperature. Maximum attenuation shall not exceed 105% of nominal value. Standard Conditions: V.S.W.R. 1.0, Ambient Temperature 20°C/Attenuation is typical value.

HFSC Riser

Super Flexible Foam Dielectric Feeder

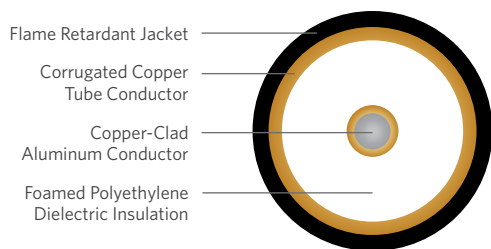

PRODUCT DESCRIPTION

HFSC-12DR is a ½ inch, 50 Ohm Riser Rated RF coaxial cable that enables mobile communications inside buildings. Installed to eliminate dead zones and spotty coverage, this cable functions as the backbone cable of in-building DAS wireless systems. With its riser (CMR) rating, this coaxial cable offers flexibility and high crush resistance in a ½ inch size. Designed for high performance, its copper clad aluminum inner conductor, foamed PE dielectric insulation, corrugated copper outer conductor and its black outer riser rated jacket exceed the requirements of all in-building DAS active systems.

APPLICATIONS

- In-building Wireless
- Distributed Antenna System (DAS)

FEATURES

- Low minimum bending radius and bending moment
- Low attenuation
- Low passive intermodulation
- Non-halogenated, fire retardant, black polyethylene jacket
- ETL Certified CMR (UL 1666)/CATVR (UL 1581)
- Full range of easy to install connectors and an automated cable prep tool

BENEFITS

- Super flexible cable is ideally suited for installations where multiple bends are required
- Highly efficient signal transfer
- Outperforms the industry requirements for low PIM
- Rugged and durable jacket slows the spread of flame without releasing toxic smoke
- Suitable for vertical cable runs in a shaft or that penetrate more than one floor within a building
- Shortens installation time and expenses

RELATED PRODUCTS

- Connectors CHFS-12xx
- Cable prep tool T-HFSC12DR
- Jumpers JR12xxxx

SPECIFICATIONS

Inner Conductor Material	Copper-clad aluminum
Dielectric Material	Foamed polyethylene
Outer Conductor Material	Corrugated copper tube
Jacket Material	Black, flame retardant PE
Recommended Operating Temperature °F (°C)	-22 to +167 (-30 to +75)

PART NUMBERS AND PHYSICAL CHARACTERISTICS

Part Number	Cable Size in (mm)	Nominal Diameter in (mm)				Minimum Bend Radius in (mm)	Approx. Weight lbs/kft (kg/km)	Flat Plate Crush Resistance lbs/in (kg/mm)	Maximum Pulling Force lbs (kg)
		Inner Conductor	Dielectric	Outer Conductor	Jacket				
HFSC-12DR	½ (12)	0.14 (3.6)	0.35 (8.9)	0.48 (12.2)	0.55 (13.9)	1.26 (32)	62 (204)	95 (1.7)	143 (65)

ELECTRICAL SPECIFICATIONS

Part Number	Cable Size in (mm)	Conductor DC Resistance Ohms/kft (Ohms/km)		Minimum Insulation Resistance mΩ km	Dielectric Strength for 1 minute DC Potential - Volts	Velocity of Propagation %	Peak Power Rating kW	Maximum Operating Frequency GHz	Characteristic Impedance Ohms	Typical Return Loss dB
		Inner	Outer							
HFSC-12DR	½ (12)	0.87 (2.85)	1.14 (3.75)	10,000	2,500	81	15.6	10.0	50 ± 2	23

Frequency MHz	Nominal Attenuation* dB/100 ft (dB/100 m)	Average Power Rating at Ambient 40°C Inner Conductor 100°C
		kW
30	0.55 (1.80)	4.87
100	1.02 (3.33)	2.62
150	1.25 (4.10)	2.12
450	2.20 (7.29)	1.19
824	3.08 (10.10)	0.85
890	3.20 (10.50)	0.82
960	3.35 (11.00)	0.79
1,000	3.41 (11.20)	0.77
1,700	4.57 (15.00)	0.57
1,800	4.72 (15.50)	0.55
2,000	5.00 (16.40)	0.52
2,400	5.55 (18.20)	0.47
3,000	6.31 (20.70)	0.41

Frequency MHz	V.S.W.R.
806-960	≤ 1.15
1,700-2,155	≤ 1.15

*The attenuation may rise by 0.2%/°C with rising temperature. Maximum attenuation shall not exceed 105% of nominal value. Standard Conditions: V.S.W.R. 1.0, Ambient Temperature 20°C/Attenuation is typical value.

PRODUCT DESCRIPTION

HFSC-12DP is a ½ inch, 50 ohm Plenum Rated RF coaxial cable that enables mobile communications inside buildings. Installed to eliminate dead zones and spotty coverage, this cable is normally installed in the plenum space on runs to ceiling antennas spaced through DAS wireless systems. With its Plenum (CMP) rating, this coaxial cable offers crush resistance in a ½ inch Super Flexible construction. Designed for high performance, its copper clad aluminum inner conductor, air dielectric center support, helically corrugated copper tube outer conductor and its white outer plenum rated jacket exceeds the RF requirements of all in-building DAS active systems.

APPLICATIONS

- In-building Wireless
- Distributed Antenna System (DAS)

FEATURES

- Low minimum bending radius and bending moment
- Low attenuation
- Low passive intermodulation
- High-quality, white PVDF jacket
- ETL Certified CMP (UL 444)
- Full range of easy to install connectors and an automated cable prep tool

BENEFITS

- Super flexible cable is ideally suited for installations where multiple bends are required
- Highly efficient signal transfer
- Outperforms the industry requirements for low PIM
- Flame retardant and low smoke; blends with background for optimal building aesthetics
- Safe to use throughout a building including air carrying plenum space
- Shortens installation time and expenses

RELATED PRODUCTS

- Connectors CHFSP12xx
- Cable prep tool T-HFSC12DP
- Jumpers JP12xxxxx

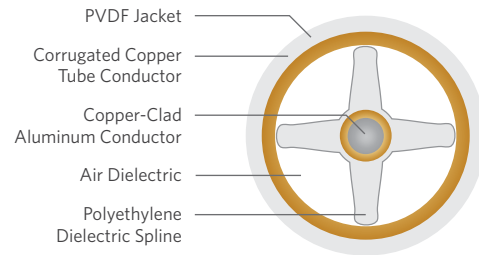

SPECIFICATIONS

Inner Conductor Material	Copper-clad aluminum
Dielectric Material	Polyethylene
Outer Conductor Material	Corrugated copper tube
Jacket Material	White, PVDF
Recommended Operating Temperature °F (°C)	-4 to +167 (-20 to +75)

PART NUMBERS AND PHYSICAL CHARACTERISTICS

Part Number	Cable Size in (mm)	Nominal Diameter in (mm)				Minimum Bend Radius in (mm)	Approx. Weight lbs/kft (kg/km)	Flat Plate Crush Resistance lbs/in (kg/mm)	Maximum Pulling Force (kg)
		Inner Conductor	Dielectric	Outer Conductor	Jacket				
HFSC-12DP	½ (12)	0.14 (3.6)	0.35 (8.9)	0.48 (12.2)	0.52 (13.2)	1.26 (32)	131 (195)	95 (1.7)	143 (65)

ELECTRICAL SPECIFICATIONS

Part Number	Cable Size in (mm)	Conductor DC Resistance Ohms/kft (Ohms/km)		Insulation Resistance mΩ km	Dielectric Strength for 1 minute DC Potential - Volts	Velocity of Propagation %	Peak Power Rating kW	Maximum Operating Frequency GHz	Characteristic Impedance Ohms	Typical Return Loss dB
		Inner	Outer							
HFSC-12DP	½ (12)	0.86 (2.85)	1.14 (3.75)	10,000	2,500	81	15.6	10.0	50 ± 2	23

Frequency MHz	Average Power Rating at Ambient 40°C Inner Conductor 100°C kW	
	Attenuation at 20°C dB/100 ft (dB/100 m)	HFSC-12DP
30	0.55 (1.80)	3.23
100	1.01 (3.33)	1.73
150	1.25 (4.10)	1.40
450	2.22 (7.29)	0.78
824	3.08 (10.10)	0.56
894	3.20 (10.50)	0.54
960	3.35 (11.00)	0.51
1,000	3.41 (11.20)	0.50
1,700	4.57 (15.00)	0.37
1,800	4.72 (15.50)	0.36
2,000	5.00 (16.40)	0.34
2,400	5.55 (18.20)	0.30
3,000	6.31 (20.70)	0.27

Frequency MHz	V.S.W.R.
806-960	≤ 1.25
1,700-2,155	≤ 1.25

Standard Conditions: V.S.W.R. 1.0, Ambient Temperature 20°C/Attenuation is typical value.

HFAC Riser

Low Loss High Flexible Foam Dielectric Feeder

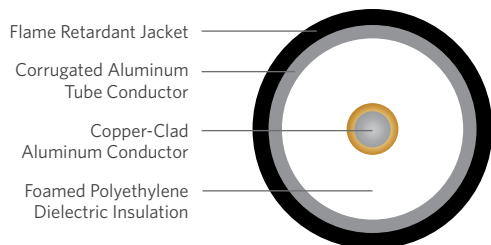

PRODUCT DESCRIPTION

HFAC-12DR is a ½ inch, 50 Ohm Riser Rated RF Coaxial Cable that enables mobile communications inside buildings. Installed to eliminate dead zones and spotty coverage, this cable functions as the backbone cable of in-building, DAS wireless systems. With its riser (CMR) rating, this coaxial cable offers flexibility and high crush resistance in a ½ inch size. Designed for high performance, its copper clad aluminum inner conductor, foamed PE dielectric insulation, corrugated aluminum outer conductor and its black outer riser rated jacket exceed the requirements of all in-building DAS active systems.

APPLICATIONS

- In-building Wireless
- Distributed Antenna System (DAS)

FEATURES

- Low attenuation
- Low passive intermodulation
- Non-halogenated, fire retardant, black polyethylene Jacket
- ETL Certified CMR(UL 1666)/CATVR (UL 1581)
- Full range of easy to install connectors and an automated cable prep tool

BENEFITS

- Highly efficient signal transfer
- Outperforms the industry requirements for low PIM
- Rugged and durable jacket slows the spread of flame without releasing toxic smoke
- Suitable for vertical cable runs in a shaft or that penetrate more than one floor within a building
- Shortens installation time and expenses

SPECIFICATIONS

Inner Conductor Material	Copper-clad aluminum
Dielectric Material	Foamed polyethylene
Outer Conductor Material	Corrugated aluminum tube
Jacket Material	Black, flame retardant PE
Recommended Operating Temperature °F (°C)	-22 to +167 (-30 to +75)

PART NUMBERS AND PHYSICAL CHARACTERISTICS

Part Number	Cable Size in (mm)	Nominal Diameter in (mm)				Minimum Bend Radius in (mm)	Approx. Weight lbs/kft (kg/km)	Flat Plate Crush Resistance lbs/in (kg/mm)	Maximum Pulling Force lbs (kg)
		Inner Conductor	Dielectric	Outer Conductor	Jacket				
HFAC-12DR	½ (12)	0.19 (4.8)	0.47 (12.0)	0.54 (13.8)	0.63 (15.9)	4.92 (125)	60 (198)	84 (1.5)	174 (79)

ELECTRICAL SPECIFICATIONS

Part Number	Cable Size in (mm)	Conductor DC Resistance Ohms/kft (Ohms/km)		Minimum Insulation Resistance mΩ km	Dielectric Strength for 1 minute DC Potential - Volts	Velocity of Propagation %	Peak Power Rating kW	Maximum Operating Frequency GHz	Characteristic Impedance Ohms	Typical Return Loss dB
		Inner	Outer							
HFAC-12DR	½ (12)	0.50 (1.6)	0.67 (2.2)	10,000	4,000	88	40	8.8	50 ± 1	21

Frequency MHz	Nominal Attenuation* dB/100 ft (dB/100 m)	Average Power Rating at Ambient 40°C Inner Conductor 100°C kW
30	0.39 (1.29)	5.95
100	0.72 (2.37)	3.24
150	0.89 (2.92)	2.63
450	1.57 (5.14)	1.50
824	2.15 (7.06)	1.09
890	2.24 (7.35)	1.05
960	2.33 (7.65)	1.01
1,000	2.38 (7.82)	0.99
1,700	3.16 (10.38)	0.75
1,800	3.26 (10.70)	0.73
2,000	3.45 (11.33)	0.69
2,400	3.81 (12.51)	0.62
3,000	4.32 (14.17)	0.55

Frequency MHz	V.S.W.R.
806-960	≤ 1.20
1,700-2,155	≤ 1.20

*The attenuation may rise by 0.2%/°C with rising temperature.
Maximum attenuation shall not exceed 110% of nominal value.
Standard Conditions: V.S.W.R. 1.0, Ambient Temperature 20°C/Attenuation is typical value.

RELATED PRODUCTS

- Connectors CHFA-12xx
- Cable prep tool T-HFA12DR

HFAC Plenum

Low Loss High Flexible Air Dielectric Feeder

PRODUCT DESCRIPTION

HFAC-12DP is a ½ inch, low loss 50 Ohm Plenum Rated RF coaxial cable that is installed in the plenum space of a building as part of an in-building DAS system to eliminate dead zones and spotty coverage. Designed with a copper clad aluminum center conductor, air dielectric center structure, helically corrugated aluminum tube outer conductor, and Plenum Rated outer jacket, the HFAC-12DP is a high performing cable with low loss attenuation.

APPLICATIONS

- In-building Wireless
- Distributed Antenna System (DAS)

FEATURES

- Low attenuation
- Low passive intermodulation
- High-quality, white PVDF jacket
- ETL Certified CMP (UL 444)
- Full range of easy to install connectors and an automated cable prep tool

BENEFITS

- Highly efficient signal transfer
- Outperforms the industry requirements for low PIM
- Flame retardant and low smoke; blends with background for optimal building aesthetics
- Safe to use throughout a building including air carrying plenum space
- Shortens installation time and expenses

RELATED PRODUCTS

- Connectors CHFAP-12xx
- Cable prep tool T-LHFA12DP

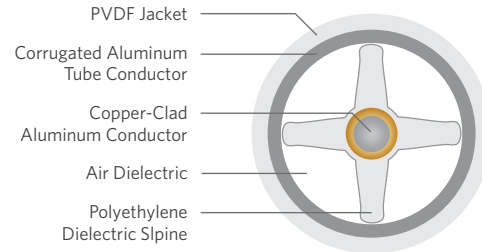

SPECIFICATIONS

Inner Conductor Material	Copper-clad aluminum
Dielectric Material	Polyethylene
Outer Conductor Material	Corrugated aluminum tube
Jacket Material	White, PVDF
Recommended Operating Temperature °F (°C)	-4 to +167 (-20 to +75)

PART NUMBERS AND PHYSICAL CHARACTERISTICS

Part Number	Cable Size in (mm)	Nominal Diameter in (mm)				Minimum Bend Radius in (mm)	Approx. Weight lbs/kft (kg/km)	Flat Plate Crush Resistance lbs/in (kg/mm)	Maximum Pulling Force lbs (kg)
		Inner Conductor	Dielectric	Outer Conductor	Jacket				
HFAC-12DP	½ (12)	0.19 (4.8)	0.47 (12.0)	0.54 (13.8)	0.58 (14.8)	5.91 (150)	111 (166)	39 (0.7)	174 (79)

ELECTRICAL SPECIFICATIONS

Part Number	Cable Size in (mm)	Conductor DC Resistance Ohms/kft (Ohms/km)		Minimum Insulation Resistance mΩ km	Dielectric Strength for 1 minute DC Potential - Volts	Velocity of Propagation %	Peak Power Rating kW	Maximum Operating Frequency GHz	Characteristic Impedance Ohms	Typical Return Loss dB
		Inner	Outer							
HFAC-12DP	½ (12)	0.50 (1.6)	0.67 (2.2)	10,000	4,000	88	40	8.8	50 ± 2	19

Frequency MHz	Nominal Attenuation* dB/100 ft (dB/100 m)	Average Power Rating at Ambient 40 °C Inner Conductor 100 °C kW
30	0.40 (1.32)	4.46
100	0.73 (2.41)	2.41
150	0.90 (2.97)	1.95
450	1.59 (5.22)	1.10
824	2.19 (7.19)	0.79
890	2.28 (7.49)	0.76
960	2.38 (7.81)	0.73
1,000	2.43 (7.98)	0.71
1,700	3.25 (10.66)	0.53
1,800	3.36 (11.03)	0.52
2,000	3.63 (11.90)	0.49
2,400	3.93 (12.90)	0.44
3,000	4.44 (14.57)	0.39

Frequency MHz	V.S.W.R.
806-960	≤ 1.25
1,700-2,155	≤ 1.25

*The attenuation may rise by 0.2%/°C with rising temperature. Maximum attenuation shall not exceed 110% of nominal value. Standard Conditions: V.S.W.R. 1.0, Ambient Temperature 20°C/Attenuation is typical value.

DAS Riser Jumper Cable



PRODUCT DESCRIPTION

Jumper cables offer outstanding electrical performance and reliability, high durability for tight routing, and superior environmental sealing for sustained longevity.

Available in ½ inch diameters, jumper cables are used in areas that require an extremely small bending radius between main feeders and antennas or between main feeders and RF equipment.

FEATURES/BENEFITS

- High pull-off strength
- Excellent V.S.W.R. performance
- Low and stable passive intermodulation
- Weatherproof

SPECIFICATIONS

Compatible Cable Type	HFSC-12DR
Compatible Cable Size in (mm)	½ (12)
Minimum Bend Radius in (mm)	1.38 (35)
Typical V.S.W.R.	1.08 over Cellular, PCS and 3G-band
Intermodulation (PIM) dBc	< -158

PART NUMBERS AND PHYSICAL CHARACTERISTICS

Part Number	Interface Type		Standard Length ft (m)	Unit of Measure
	End 1	End 2		
JR121NMNM	N Male Straight	N Male Straight	3.2 (1)	Each
JR122NMNM	N Male Straight	N Male Straight	6.6 (2)	Each
JR123NMNM	N Male Straight	N Male Straight	9.8 (3)	Each
JR121NMNF	N Male Straight	N Female Straight	3.2 (1)	Each
JR122NMNF	N Male Straight	N Female Straight	6.6 (2)	Each
JR123NMNF	N Male Straight	N Female Straight	9.8 (3)	Each
JR121NFnF	N Female Straight	N Female Straight	3.2 (1)	Each
JR122NFnF	N Female Straight	N Female Straight	6.6 (2)	Each
JR123NFnF	N Female Straight	N Female Straight	9.8 (3)	Each
JR121NMRM	N Male Straight	N Male Right Angle	3.2 (1)	Each
JR122NMRM	N Male Straight	N Male Right Angle	6.6 (2)	Each
JR123NMRM	N Male Straight	N Male Right Angle	9.8 (3)	Each
JR121NMRF	N Male Straight	N Female Right Angle	3.2 (1)	Each
JR122NMRF	N Male Straight	N Female Right Angle	6.6 (2)	Each
JR123NMRF	N Male Straight	N Female Right Angle	9.8 (3)	Each
JR121NFRF	N Female Straight	N Female Right Angle	3.2 (1)	Each
JR122NFRF	N Female Straight	N Female Right Angle	6.6 (2)	Each
JR123NFRF	N Female Straight	N Female Right Angle	9.8 (3)	Each

EXPLANATION OF PART NUMBERS

JR122NMNM

Product Category	Fire Safety Listing	Compatible Cable Size	Jumper Length	Connector for End 1	Connector for End 2
J = Jumper Cable	R = Riser Rating P = Plenum Rating	12 = ½ inch (12 mm)	1 = 1 meter 2 = 2 meters 3 = 3 meters	NM = N Male straight RM = N Right angle Male NF = N Female RF = N Right angle Female	NM = N Male straight RM = N Right angle Male NF = N Female RF = N Right angle Female

DAS Plenum Jumper Cable

PRODUCT DESCRIPTION

Jumper cables offer outstanding electrical performance and reliability, high durability for tight routing, and superior environmental sealing for sustained longevity.

Available in ½ inch diameters, jumper cables are used in areas that require an extremely small bending radius between main feeders and antennas or between main feeders and RF equipment.

FEATURES/BENEFITS

- High pull-off strength
- Excellent V.S.W.R. performance
- Low and stable passive intermodulation
- Weatherproof



SPECIFICATIONS

Compatible Cable Type	HFSC-12DP
Compatible Cable Size in (mm)	½ (12)
Minimum Bend Radius in (mm)	1.38 (35)
Typical V.S.W.R.	1.08 over Cellular, PCS and 3G-band
Intermodulation (PIM) dBc	< -158

PART NUMBERS AND PHYSICAL CHARACTERISTICS

Part Number	Interface Type		Standard Length ft (m)	Unit of Measure
	End 1	End 2		
JP121NMNM	N Male Straight	N Male Straight	3.2 (1)	Each
JP122NMNM	N Male Straight	N Male Straight	6.6 (2)	Each
JP123NMNM	N Male Straight	N Male Straight	9.8 (3)	Each
JP121NMNF	N Male Straight	N Female Straight	3.2 (1)	Each
JP122NMNF	N Male Straight	N Female Straight	6.6 (2)	Each
JP123NMNF	N Male Straight	N Female Straight	9.8 (3)	Each
JP121NFNF	N Female Straight	N Female Straight	3.2 (1)	Each
JP122NFNF	N Female Straight	N Female Straight	6.6 (2)	Each
JP123NFNF	N Female Straight	N Female Straight	9.8 (3)	Each
JP121NMRRM	N Male Straight	N Male Right Angle	3.2 (1)	Each
JP122NMRRM	N Male Straight	N Male Right Angle	6.6 (2)	Each
JP123NMRRM	N Male Straight	N Male Right Angle	9.8 (3)	Each
JP121NMRF	N Male Straight	N Female Right Angle	3.2 (1)	Each
JP122NMRF	N Male Straight	N Female Right Angle	6.6 (2)	Each
JP123NMRF	N Male Straight	N Female Right Angle	9.8 (3)	Each
JP121NFRF	N Female Straight	N Female Right Angle	3.2 (1)	Each
JP122NFRF	N Female Straight	N Female Right Angle	6.6 (2)	Each
JP123NFRF	N Female Straight	N Female Right Angle	9.8 (3)	Each

EXPLANATION OF PART NUMBERS

JR122NMNM

Product Category	Fire Safety Listing	Compatible Cable Size	Jumper Length	Connector for End 1	Connector for End 2
J = Jumper Cable	R = Riser Rating P = Plenum Rating	12 = ½ inch (12 mm)	1 = 1 meter 2 = 2 meters 3 = 3 meters	NM = N Male straight RM = N Right angle Male NF = N Female RF = N Right angle Female	NM = N Male straight RM = N Right angle Male NF = N Female RF = N Right angle Female

DIN Series for LHF



SPECIFICATIONS

Bodies, Cap (Coupling Nut) Material	Brass/silver plated or Su Co (Alloy of Cu/Sn/Zn) plated
Back Nut Material	Brass/nickel plated
Pin Material	Male: Brass/silver plated or Su Co (Alloy of Cu/Sn/Zn) plated Female: Beryllium - copper/silver plated or Su Co (Alloy of Cu/Sn/Zn) plated
Insulator Material	Plated PTFE (Teflon®)
Gasket Material	Silicon rubber

ELECTRICAL SPECIFICATIONS

Impedance Ω	50
Maximum Frequency Range GHz	7.5
V.S.W.R. (Mating) straight (right angle)	1 GHz: 1.08 (1.12) 2 GHz: 1.10 (1.15)
Maximum Insertion Loss dB @ 3 GHz	-0.2
Intermodulation (PIM) dBc	< -155
Dielectric Withstanding Voltage kV rms @ 50 Hz	4.0
Working Voltage kV rms @ 50 Hz	2.7
Insulation Resistance GΩ	10
Contact Resistance mΩ	Inner: ≤ 1.5 Outer: ≤ 1.5

PRODUCT DESCRIPTION

This DIN Series is compatible with the LHF In-Building Series. The connectors are manufactured from an alloy material of copper, tin and zinc to produce a highly polished, precise, and strong connector. This alloy combination allows a better operating temperature range and improved environmental performance.

FEATURES/BENEFITS

- Two-piece design is the industry standard
- Simple, user-friendly installation process
- Connector can be disassembled and re-used
- Offers stable connections

ENVIRONMENTAL SPECIFICATIONS

Temperature Range °F (°C)	-49 to +185 (-40 to +85)
Corrosion (Salt Spray Test)	IEC-68-2-11-Ka
Vibration	CECC 22000 Part 4.6.3
Waterproof	IP68

PART NUMBERS AND PHYSICAL CHARACTERISTICS

Part Number	Compatible Cable Type	Compatible Cable Size in (mm)	DIN Interface Type		Length in (mm)	Diameter in (mm)	Weight oz (g)
			Gender	Straight or Angle			
CLH-12DF	LHF Riser	½ (12)	Female	Straight	2.65 (67.4)	0.86 (21.8)	5.3 (150)
CLH-12DM	LHF Riser	½ (12)	Male	Straight	2.57 (65.4)	0.86 (21.8)	6.5 (183)
CLH-12DMR	LHF Riser	½ (12)	Male	Right Angle	-	-	-
CLHP-12DF	LHF Plenum	½ (12)	Female	Straight	2.26 (57.4)	0.86 (21.8)	5.3 (150)
CLHP-12DM	LHF Plenum	½ (12)	Male	Straight	2.18 (55.4)	0.86 (21.8)	5.3 (150)
CLHP12DMR	LHF Plenum	½ (12)	Male	Right Angle	-	-	-



TECHNICAL GUIDELINE

Installation guidelines are available for these connectors. Refer to the "Resources" section on our site for the Technical Guideline, "DIN Connectors and N Connectors Installation Guidelines," for more information.

DIN Series for HFSC

PRODUCT DESCRIPTION

This DIN Series is compatible with the HFSC In-Building Series. The connectors are manufactured from an alloy material of copper, tin and zinc to produce a highly polished, precise, and strong connector. This alloy combination allows a better operating temperature range and improved environmental performance.

FEATURES/BENEFITS

- Two-piece design is the industry standard
- Simple, user-friendly installation process
- Ordinary tools needed; available in a common installers tool bag
- Connector can be disassembled and re-used
- Offers stable connections



SPECIFICATIONS

Bodies, Cap (Coupling Nut) Material	Brass/silver plated or Su Co (Alloy of Cu/Sn/Zn) plated
Back Nut Material	Brass/nickel plated
Pin Material	Male: Brass/silver plated or Su Co (Alloy of Cu/Sn/Zn) plated Female: Beryllium - copper/silver plated or Su Co (Alloy of Cu/Sn/Zn) plated
Insulator Material	Plated PTFE (Teflon®)
Gasket Material	Silicon rubber

ELECTRICAL SPECIFICATIONS

Impedance Ω	50
Maximum Frequency Range GHz	7.5
V.S.W.R. (Mating) straight (right angle)	1 GHz: 1.08 (1.12) 2 GHz: 1.10 (1.15)
Maximum Insertion Loss dB @ 3 GHz	-0.2
Intermodulation (PIM) dBc	< -155
Dielectric Withstanding Voltage kV rms @ 50 Hz	4.0
Working Voltage kV rms @ 50 Hz	2.7
Insulation Resistance GΩ	10
Contact Resistance mΩ	Inner: 0.4 Outer: 1.5

ENVIRONMENTAL SPECIFICATIONS

Temperature Range °F (°C)	-85 to +329 (-65 to +165)
Corrosion (Salt Spray Test)	IEC-68-2-11-Ka
Vibration	CECC 22000 Part 4.6.3
Waterproof	IP68

PART NUMBERS AND PHYSICAL CHARACTERISTICS

Part Number	Compatible Cable Type	Compatible Cable Size in (mm)	DIN Interface Type		Length in (mm)	Diameter in (mm)	Weight oz (g)
			Gender	Straight or Angle			
CHFS-12DF	HFSC Riser	½ (12)	Female	Straight	2.65 (67.4)	0.86 (21.8)	5.3 (150)
CHFS-12DM	HFSC Riser	½ (12)	Male	Straight	2.57 (65.4)	0.86 (21.8)	6.5 (183)
CHFS12DMR	HFSC Riser	½ (12)	Male	Right Angle	-	-	-
CHFSP12DF	HFSC Plenum	½ (12)	Female	Straight	2.21 (56.2)	0.92 (23.4)	5.3 (150)
CHFSP12DM	HFSC Plenum	½ (12)	Male	Straight	2.25 (57.3)	0.92 (23.4)	6.5 (183)
CHFSP12DMR	HFSC Plenum	½ (12)	Male	Right Angle	-	-	-



TECHNICAL GUIDELINE

Installation guidelines are available for these connectors. Refer to the "Resources" section on our site for the Technical Guideline, "DIN Connectors and N Connectors Installation Guidelines," for more information.

DIN Series for HFAC



SPECIFICATIONS

Bodies, Cap (Coupling Nut) Material	Brass/silver plated or Su Co (Alloy of Cu/Sn/Zn) plated
Back Nut Material	Brass/nickel plated
Pin Material	Male: Brass/silver plated or Su Co (Alloy of Cu/Sn/Zn) plated Female: Beryllium - copper/silver plated or Su Co (Alloy of Cu/Sn/Zn) plated
Insulator Material	Plated PTFE (Teflon®)
Gasket Material	Silicon rubber

ELECTRICAL SPECIFICATIONS

Impedance Ω	50
Maximum Frequency Range GHz	7.5
V.S.W.R. (Mating) straight (right angle)	1 GHz: 1.08 (1.12) 2 GHz: 1.10 (1.15)
Maximum Insertion Loss dB @ 3 GHz	-0.2
Intermodulation (PIM) dBc	< -155
Dielectric Withstanding Voltage kV rms @ 50 Hz	4.0
Working Voltage kV rms @ 50 Hz	2.7
Insulation Resistance GΩ	10
Contact Resistance mΩ	Inner: 0.4 Outer: 1.5

PRODUCT DESCRIPTION

This DIN Series is compatible with the HFAC In-Building Series. The connectors are manufactured from an alloy material of copper, tin and zinc to produce a highly polished, precise, and strong connector. This alloy combination allows a better operating temperature range and improved environmental performance.

FEATURES/BENEFITS

- Two-piece design is the industry standard
- Simple, user-friendly installation process
- Ordinary tools needed; available in a common installers tool bag
- Connector can be disassembled and re-used
- Offers stable, low PIM connections

ENVIRONMENTAL SPECIFICATIONS

Temperature Range °F (°C)	-85 to +329 (-65 to +165)
Corrosion (Salt Spray Test)	IEC-68-2-11-Ka
Vibration	CECC 22000 Part 4.6.3
Waterproof	IP68

PART NUMBERS AND PHYSICAL CHARACTERISTICS

Part Number	Compatible Cable Type	Compatible Cable Size in (mm)	DIN Interface Type		Length in (mm)	Diameter in (mm)	Weight oz (g)
			Gender	Straight or Angle			
CHFA-12DF	HFAC Riser	½ (12)	Female	Straight	2.65 (67.4)	0.86 (21.8)	5.3 (150)
CHFA-12DM	HFAC Riser	½ (12)	Male	Straight	2.57 (65.4)	0.86 (21.8)	6.5 (183)
CHFA12DMR	HFAC Riser	½ (12)	Male	Right Angle	-	-	-
CHFAP12DF	HFAC Plenum	½ (12)	Female	Straight	2.26 (57.4)	0.86 (21.8)	5.3 (150)
CHFAP12DM	HFAC Plenum	½ (12)	Male	Straight	2.18 (55.4)	0.86 (21.8)	5.3 (150)
CHFAP12DMR	HFAC Plenum	½ (12)	Male	Right Angle	-	-	-



TECHNICAL GUIDELINE

Installation guidelines are available for these connectors. Refer to the "Resources" section on our site for the Technical Guideline, "DIN Connectors and N Connectors Installation Guidelines," for more information.

N Series for LHF

PRODUCT DESCRIPTION

This N Series connector is compatible with the LHF Series In-building Cable. The connectors are manufactured from an alloy material of copper, tin and zinc to produce a highly polished, strong connector. This alloy combination allows for a better operating temperature range and improved environmental performance.

FEATURES/BENEFITS

- Two-piece design is the industry standard
- Simple user friendly installation process
- Connector can be disassembled and re-used
- Offers stable, low PIM connections



TECHNICAL GUIDELINE

Installation guidelines are available for these connectors. Refer to the "Resources" section on our site for an instructional video or the Technical Guideline, "DIN Connectors and N Connectors Installation Guidelines," for more information.



SPECIFICATIONS

Bodies, Cap (Coupling Nut) Material	Brass/silver plated or Su Co (Alloy of Cu/Sn/Zn) plated
Back Nut Material	Brass/nickel plated
Pin Material	Male: Brass/silver plated or Su Co (Alloy of Cu/Sn/Zn) plated Female: Beryllium - copper/silver plated or Su Co (Alloy of Cu/Sn/Zn) plated
Insulator Material	Plated PTFE (Teflon®)
Gasket Material	Silicon rubber
Recommended Coupling Nut Torque Nm	0.68-1.13
Coupling Nut Retention Force Nm	1,000
Contact Captivation N	200
Mating Durability	500 times

ELECTRICAL SPECIFICATIONS

Impedance Ω	50
Maximum Frequency Range GHz	7.5
V.S.W.R. @ 700-2,200 MHz straight (right angle)	1.08 (1.15)
Maximum Insertion Loss dB @ 700-2,200 MHz straight (right angle)	0.1 (0.15)
Intermodulation (PIM) dBc	-155
Dielectric Withstanding Voltage kV rms @ 50 Hz	4.0
Working Voltage kV rms @ 50 Hz	2.7
Peak Power kW	10
Insulation Resistance M Ω	$\geq 5,000$
Contact Resistance m Ω	Inner: ≤ 1.0 Outer: ≤ 1.0

ENVIRONMENTAL SPECIFICATIONS

Temperature Range $^{\circ}\text{F}$ ($^{\circ}\text{C}$)	-40 to +185 (-40 to +85)
Corrosion (Salt Spray Test)	IEC-68-2-11-Ka
Vibration	CECC 22000 Part 4.6.3
Waterproof	IP68

PART NUMBERS AND PHYSICAL CHARACTERISTICS

Part Number	Compatible Cable Type	Compatible Cable Size in (mm)	N Interface Type		Length in (mm)	Diameter in (mm)	Weight oz (g)
			Gender	Straight or Angle			
CLH-12NF	LHF Riser	½ (12)	Female	Straight	2.75 (69.8)	0.86 (21.8)	4.1 (115)
CLH-12NFR	LHF Riser	½ (12)	Female	Right Angle	-	-	-
CLH-12NM	LHF Riser	½ (12)	Male	Straight	2.75 (69.8)	0.86 (21.8)	4.2 (120)
CLH-12NMR	LHF Riser	½ (12)	Male	Right Angle	-	-	-
CLHP-12NF	LHF Plenum	½ (12)	Female	Straight	2.75 (69.8)	0.86 (21.8)	4.1 (115)
CLHP12NFR	LHF Plenum	½ (12)	Female	Right Angle	-	-	-
CLHP12NM	LHF Plenum	½ (12)	Male	Straight	2.75 (69.8)	0.86 (21.8)	4.2 (120)
CLHP12NMR	LHF Plenum	½ (12)	Male	Right Angle	-	-	-

N Series for HFSC



SPECIFICATIONS

Bodies, Cap (Coupling Nut) Material	Brass/silver plated or Su Co (Alloy of Cu/Sn/Zn) plated
Back Nut Material	Brass/nickel plated
Pin Material	Male: Brass/silver plated or Su Co (Alloy of Cu/Sn/Zn) plated Female: Beryllium - copper/silver plated or Su Co (Alloy of Cu/Sn/Zn) plated
Insulator Material	Plated PTFE (Teflon®)
Gasket Material	Silicon rubber
Recommended Coupling Nut Torque Nm	25-30
Coupling Nut Retention Force Nm	1,000
Contact Captivation N	200
Mating Durability	500 times

ELECTRICAL SPECIFICATIONS

Impedance Ω	50
Maximum Frequency Range GHz	7.5
V.S.W.R. @ 700-2,200 MHz straight (right angle)	1.08 (1.10)
Maximum Insertion Loss dB @ @ 700-2,200 MHz straight (right angle)	0.1 (0.15)
Intermodulation (PIM) dBc	-155
Dielectric Withstanding Voltage kV rms @ 50 Hz	4.0
Working Voltage kV rms @ 50 Hz	2.7
Peak Power kW	10
Insulation Resistance M Ω	$\geq 5,000$
Contact Resistance m Ω	Inner: 1.0 Outer: 1.0

PART NUMBERS AND PHYSICAL CHARACTERISTICS

Part Number	Compatible Cable Type	Compatible Cable Size in (mm)	N Interface Type		Length in (mm)	Diameter in (mm)	Weight oz (g)
			Gender	Straight or Angle			
CHFS-12NF	HFSC Riser	½ (12)	Female	Straight	2.75 (69.8)	0.86 (21.8)	4.1 (115)
CHFS12NFR	HFSC Riser	½ (12)	Female	Right Angle	-	-	-
CHFS-12NM	HFSC Riser	½ (12)	Male	Straight	2.75 (69.8)	0.86 (21.8)	4.2 (120)
CHFS12NMR	HFSC Riser	½ (12)	Male	Right Angle	-	-	-
CHFSP12NF	HFSC Plenum	½ (12)	Female	Straight	2.75 (69.8)	0.86 (21.8)	4.1 (115)
CHFSP12NFR	HFSC Plenum	½ (12)	Female	Right Angle	-	-	-
CHFSP12NM	HFSC Plenum	½ (12)	Male	Straight	2.75 (69.8)	0.86 (21.8)	4.2 (120)
CHFSP12NMR	HFSC Plenum	½ (12)	Male	Right Angle	-	-	-

PRODUCT DESCRIPTION

This N Series connector is compatible with the HFSC Series In-building Cable. The connectors are manufactured from an alloy material of copper, tin and zinc to produce a highly polished, strong connector. This alloy combination allows for a better operating temperature range and improved environmental performance.

FEATURES/BENEFITS

- Two-piece design is the industry standard
- Simple user-friendly installation process
- Connector can be disassembled and re-used
- Offers stable, low PIM connections



TECHNICAL GUIDELINE

Installation guidelines are available for these connectors. Refer to the "Resources" section on our site for an instructional video or the Technical Guideline, "DIN Connectors and N Connectors Installation Guidelines," for more information.

ENVIRONMENTAL SPECIFICATIONS

Temperature Range °F (°C)	-40 to +185 (-40 to +85)
Corrosion (Salt Spray Test)	IEC-68-2-11-Ka
Vibration	CECC 22000 Part 4.6.3
Waterproof	IP68

N Series for HFAC

PRODUCT DESCRIPTION

This N Series connector is compatible with the HFAC Series In-building Cable. The connectors are manufactured from an alloy material of copper, tin and zinc to produce a highly polished, strong connector. This alloy combination allows for a better operating temperature range and improved environmental performance.

FEATURES/BENEFITS

- Two-piece design is the industry standard
- Simple user-friendly installation process
- Connector can be disassembled and re-used
- Offers stable, low PIM connections



TECHNICAL GUIDELINE

Installation guidelines are available for these connectors. Refer to the "Resources" section on our site for an instructional video or the Technical Guideline, "DIN Connectors and N Connectors Installation Guidelines," for more information.



SPECIFICATIONS

Bodies, Cap (Coupling Nut) Material	Brass/silver plated or Su Co (Alloy of Cu/Sn/Zn) plated
Back Nut Material	Brass/nickel plated
Pin Material	Male: Brass/silver plated or Su Co (Alloy of Cu/Sn/Zn) plated Female: Beryllium - copper/silver plated or Su Co (Alloy of Cu/Sn/Zn) plated
Insulator Material	Plated PTFE (Teflon®)
Gasket Material	Silicon rubber
Recommended Coupling Nut Torque Nm	0.68-1.13
Coupling Nut Retention Force Nm	1,000
Contact Captivation N	200
Mating Durability	500 times

ELECTRICAL SPECIFICATIONS

Impedance Ω	50
Maximum Frequency Range GHz	7.5
V.S.W.R. @ 700-2,200 MHz straight (right angle)	1.08 (1.10)
Maximum Insertion Loss dB @ 700-2,200 MHz straight (right angle)	0.1 (0.15)
Intermodulation (PIM) dBc	-155
Dielectric Withstanding Voltage kV rms @ 50 Hz	4.0
Working Voltage kV rms @ 50 Hz	2.7
Peak Power kW	10
Insulation Resistance G Ω	$\geq 5,000$
Contact Resistance m Ω	Inner: ≤ 1.0 Outer: ≤ 1.0

ENVIRONMENTAL SPECIFICATIONS

Temperature Range °F (°C)	-40 to +185 (-40 to +85)
Corrosion (Salt Spray Test)	IEC-68-2-11-Ka
Vibration	CECC 22000 Part 4.6.3
Waterproof	IP68

PART NUMBERS AND PHYSICAL CHARACTERISTICS

Part Number	Compatible Cable Type	Compatible Cable Size in (mm)	N Interface Type		Length in (mm)	Diameter in (mm)	Weight oz (g)
			Gender	Straight or Angle			
CHFA-12NF	HFAC Riser	½ (12)	Female	Straight	2.75 (69.8)	0.86 (21.8)	4.1 (115)
CHFA12NFR	HFAC Riser	½ (12)	Female	Right Angle	-	-	-
CHFA-12NM	HFAC Riser	½ (12)	Male	Straight	2.75 (69.8)	0.86 (21.8)	4.2 (120)
CHFA12NMR	HFAC Riser	½ (12)	Male	Right Angle	-	-	-
CHFAP12NF	HFAC Plenum	½ (12)	Female	Straight	2.75 (69.8)	0.86 (21.8)	4.1 (115)
CHFAP12NFR	HFAC Plenum	½ (12)	Female	Right Angle	-	-	-
CHFAP12NM	HFAC Plenum	½ (12)	Male	Straight	2.75 (69.8)	0.86 (21.8)	4.2 (120)
CHAP12NMR	HFAC Plenum	½ (12)	Male	Right Angle	-	-	-

Cable Preparation Tools



Manual Cutting Tools

Automated Cutting Tool

Flare Tool

Blade Replacement Kit

PRODUCT DESCRIPTION

Connector termination is one of the most important factors affecting Radio Frequency (RF) transmission line operation. Cable cutting tools are offered in sizes ranging from ½ to 1½ inches (12 to 42 mm). These precision tools are designed to cut the jacket and outer conductor quickly and easily.

Cutting tools make accurate cuts in the cable at exact distance requirements for easy connector assembly. The automated cable cutting tools fit standard cordless 18V drills. Blade replacement kits are available to extend the useful life of the automated cutting tools.

The foam separator and flare tool removes foam dielectric from riser cable and flares the top of the outer conductor over top of riser and plenum connectors.

FEATURES/BENEFITS

- Accurate termination
- Easy handling

CUTTING TOOLS

Part Number	Tool Type	Capability	Compatible Cable Size in (mm)	Compatible Cable Type	Unit of Measure
L-CT-12D	Manual	Cuts jacket and outer conductor	½ (12)	LHF Feeder, HFAC Feeder	Each
L-CT-12DS	Manual	Cuts inner/outer jackets	½ (12)	HFSC Feeder	Each
L-CT-22D	Manual	Cuts jacket, inner/outer conductors and dielectric	7/8 (22)	LHF Feeder	Each
T-LHFA12DP	Automated	Cuts jacket, outer conductor and dielectric	½ (12)	LHF-12DP, HFAC-12DP	Each
T-HFSC12DP	Automated	Cuts jacket, outer conductor and dielectric	½ (12)	HFSC-12DP	Each
T-LHF12DR	Automated	Cuts jacket, outer conductor and dielectric	½ (12)	LHF-12DR	Each
T-HFAC12DR	Automated	Cuts jacket, outer conductor and dielectric	½ (12)	HFAC-12DR	Each
T-HFSC12DR	Automated	Cuts jacket, outer conductor and dielectric	½ (12)	HFSC-12DR	Each

FLARE TOOLS

Part Number	Description	Compatible Cable Size in (mm)	Compatible Cable Type	Unit of Measure
TF-LHFA12	Foam separator and flare tool	½ (12)	LHF-12DP, LHF-12DR, HFAC-12DP, HFAC-12DR	Each
TF-HFSC12	Foam separator and flare tool	½ (12)	HFSC-12DP, HFSC-12DR	Each
L-FT-42D	T-handle flare tool	1½ (42)	LHF-42D, LHF-42DU, LHF-42DUF	Each

BLADE REPLACEMENT KITS

Part Number	Description	Compatible Tools	Each Kit Includes	Unit of Measure
TBK-HFSC12	Blade replacement kit for HFSC automated tools	T-HFSC12DP, T-HFSC12DR	<ul style="list-style-type: none"> • Three (3) replacement blades • Three (3) set screws • One (1) Allen wrench 	Kit
TBK-LHFA12	Blade replacement kit for LHF and HFAC automated tools	T-LHFA12DP, T-LHF12DR, T-HFAC12DR	<ul style="list-style-type: none"> • Four (4) replacement blades • Four (4) set screws • One (1) Allen wrench 	Kit

Cushion and Boot Assembly Kit

PRODUCT DESCRIPTION

These innovative boot assembly kits feature a boot assembly and standard cushion insert in one convenient package. The unique boot assembly features a split, one-piece design that dramatically reduces installation time and difficulty. Boot assembly kits are designed to be fitted onto EP-series entry panels in wall/roof feed-thru applications.

APPLICATION

- Entry solutions

FEATURES/BENEFITS

- One-piece design simplifies installation



SPECIFICATIONS

Size	Versions for coax
Design	Compression boot kit for aluminum entry panels
Mounts to	4 inch (102 mm) entry panels
Material	EPDM rubber
Each Kit Includes	<ul style="list-style-type: none"> ▪ One (1), 4 inch (101.6 mm) pre-molded grooved boot ▪ One (1) cushion insert with appropriately sized hole(s) for corrugated coax or flexible coax ▪ One (1), #80 round member hose clamp ▪ One (1), #64 round member hose clamp ▪ One (1) installation instruction sheet
Not Included (Order Separately)	4 inch (102 mm) entry panel

PART NUMBERS AND PHYSICAL CHARACTERISTICS

Part Number	Compatible Cable Size in (mm)	Compatible Cable Type	Number of Holes	Weight lbs (kg)	Unit of Measure
LBA-12-1A	½ (12)	Corrugated Coax	1	1.6 (0.7)	Kit
LBA-12-2A	½ (12)	Corrugated Coax	2	1.6 (0.7)	Kit
LBA-12-3A	½ (12)	Corrugated Coax	3	1.6 (0.7)	Kit
LBA-12-4A	½ (12)	Corrugated Coax	4	1.6 (0.7)	Kit
LBA-12-5A	½ (12)	Corrugated Coax	5	1.6 (0.7)	Kit
LBA-22-1A	⅞ (22)	Corrugated Coax	1	1.6 (0.7)	Kit
LBA-22-2A	⅞ (22)	Corrugated Coax	2	1.6 (0.7)	Kit
LBA-22-3A	⅞ (22)	Corrugated Coax	3	1.6 (0.7)	Kit
LBA-22-4A	⅞ (22)	Corrugated Coax	4	1.6 (0.7)	Kit
LBA-33-1A	1¼ (33)	Corrugated Coax	1	1.6 (0.7)	Kit
LBA-42-1A	1⅝ (42)	Corrugated Coax	1	1.6 (0.7)	Kit
LBA-57-1A	2¼ (57)	Corrugated Coax	1	1.6 (0.7)	Kit

Universal Weatherproofing Kit



PRODUCT DESCRIPTION

Universal weatherproofing kits include mastic and electrical tapes to provide a multi-layer, long-term environmental seal over multiple connections.

APPLICATION

- Coax protection

FEATURES/BENEFITS

- Multi-connection protection
- Tape kit for multi-layer wrap

SPECIFICATIONS

Material	Butyl and vinyl tape
Each Kit Includes	<ul style="list-style-type: none"> ▪ Five (5) rolls of butyl mastic tape 3.75 inches x 2 feet (95 mm x 0.6 m) ▪ Two (2) rolls of electrical tape 0.75 inch x 44 feet (19 mm x 13 m) ▪ One (1) roll of electrical tape 2 inch x 20 feet (51 mm x 6 m) ▪ One (1) installation instruction sheet

PART NUMBERS AND PHYSICAL CHARACTERISTICS

Part Number	Weight lbs (kg)	Unit of Measure
L-WK-U	3.4 (1.5)	Kit

PRODUCT DESCRIPTION

Hoisting grips provide an effective means for hoisting coax and elliptical waveguide into position. Grips can be used to provide additional support once in place. The lace-up design allows the hoisting grip to be attached even when the run has been connectorized, and it facilitates easy positioning at 200 feet (61 m) increments on long coax runs.

Pre-laced hoisting grips feature a closed-mesh design which simplifies installation over traditional split, lace-up style grips. The unique design allows the pre-laced hoisting grip to slip over an unterminated end of a coax cable. The grip securely tightens when pulled, providing an effective means to hoist coax into position, while providing additional support for the coax once in place.

Hoisting grip kits include a self-locking clip and sealing tape, giving additional support both during and after installation.

APPLICATION

- Coax
- Coax support

FEATURES/BENEFITS

- Lace-up installation at any point on coax
- Pre-laced to simplify installation
- Mesh grip with single eye support

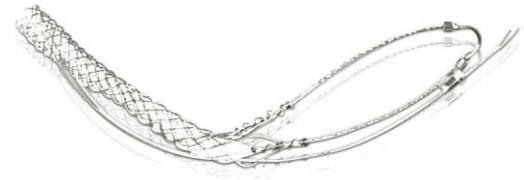

SPECIFICATIONS

Compatible Cable Type	Corrugated coax
Compatible Cable Size in (mm)	Fits ½ (12) to 1½ (42) corrugated coax
Material	Tinned bronze
Each Includes	<ul style="list-style-type: none"> • One (1) mesh grip • One (1) self-locking clip • Installation instructions

PART NUMBERS AND PHYSICAL CHARACTERISTICS

Part Number	Hoisting Grip Model	Compatible Cable Size in (mm)	Weight lbs (kg)	Unit of Measure
L-HG-12	Lace-Up	½ (12)	0.3 (0.1)	Each
L-HG-22	Lace-Up	⅞ (22)	0.6 (0.3)	Each
L-HG-33	Lace-Up	1¼ (33)	0.6 (0.3)	Each
L-HG-42	Lace-Up	1½ (42)	1.3 (0.6)	Each
L-HG-12L	Pre-Laced	½ (12)	0.4 (0.2)	Each
L-HG-22L	Pre-Laced	⅞ (22)	0.5 (0.2)	Each
L-HG-33L	Pre-Laced	1¼ (33)	0.5 (0.2)	Each
L-HG-42L	Pre-Laced	1½ (42)	0.5 (0.2)	Each

Clip-On Grounding Kit



SPECIFICATIONS

Compatible Cable Type	Corrugated coax
Compatible Cable Size in (mm)	Fits ½ (12) to 1¾ (42)
Mounts to	Coax outer conductor
Material	Copper strap
Each Kit Includes	<ul style="list-style-type: none"> One (1) 6 AWG, 7-strand copper ground lead measuring 4.92 feet (1.5 m) long One (1) roll of electrical tape 2 inch x 20 feet (51 mm x 6 m) One (1) roll of butyl mastic tape 3.75 inch x 2 feet (95 mm x 0.6 m) Necessary hardware for ground bar attachment One (1) 2-hole universal lug compatible with ½ inch (12 mm) coax

PART NUMBERS AND PHYSICAL CHARACTERISTICS

Part Number	Compatible Cable Size in (mm)	Weight lbs (kg)	Unit of Measure
L-GK-C12	½ (12)	1.4 (0.6)	Kit
L-GK-C22	⅞ (22)	1.4 (0.6)	Kit
L-GK-C33	1¼ (33)	1.4 (0.6)	Kit
L-GK-C42	1¾ (42)	1.5 (0.7)	Kit

*Note: 0.375 inch (10 mm) two-hole lugs are universal to accommodate 0.75 inch to 1 inch (19 mm to 25 mm) spacing requirements. Versions of these kits are available with 0.25 inch (6 mm) two-hole lugs or with your choice of lug pre-attached.

PRODUCT DESCRIPTION

Clip-on ground kits, as part of an advanced coax grounding solution, provide easy installation coupled with dependable protection of your coaxial cable system. The unique clip design and pre-formed strap allows the clip-on ground kits to slip easily over the outer conductor of the coax and firmly latch into place. The latch mechanism has been optimized to provide a secure fit, maximizing performance by ensuring proper contact surface area and pressure. The innovative design of the clip-on ground kits greatly simplifies installation, and minimizes installation time over traditional coiled and bolt-on grounding kits. This design also eliminates the danger of over tightening, which reduces the chance of costly errors in the field. The clip-on ground kits comply with MIL-STD-188-124A, protecting coax from the damaging effects of lightning current in excess of 200 kA. Each kit includes a 6 AWG 7-strand copper ground lead. All bus bar attachment hardware is included along with required mastic and electric tape for weatherproofing each kit.

APPLICATION

- Coax protection

FEATURES/BENEFITS

- Easy-to-install clip design
- One-piece style with three lead/lug options

Universal Snap-in Hanger Kit

PRODUCT DESCRIPTION

The next-generation Universal Snap-in Hangers incorporate numerous innovative design features that ensure secure, dependable support and simplified installation for your coaxial cable system. The unique internal coax fingers securely grip the coax, yet float freely within the hanger to ensure flexibility during installation. The tension and thickness of steel has been optimized to minimize stiffness and allow easy insertion into a 3/4 inch (19 mm) mounting hole. The advanced snap-in fingers are specifically designed to eliminate inadvertent pop-out. The unique curved finger-tips provide a powerful barrier to pop-out and offer additional security when faced with excessive galvanizing or rounded edges. The Universal Snap-in Hangers internal ribbing and dog-eared internal fingers provide a firm grip to resist coax slippage. The stainless steel construction guarantees exceptional integrity in highly corrosive environments and extreme weather conditions.

APPLICATION

- Coax support

FEATURES

- One-piece hanger solution

BENEFITS

- Simplified coax installation



SPECIFICATIONS

Compatible Cable Type	Corrugated coax
Compatible Cable Size in (mm)	1/2 (12) to 2 1/4 (58)
Mounts to in (mm)	3/4 (19) holes
Material	Stainless steel
Each Kit Includes	<ul style="list-style-type: none"> 10 appropriately sized snap-in hangers One (1) installation instruction sheet
Not Included (Order Separately)	Brackets

PART NUMBERS AND PHYSICAL CHARACTERISTICS

Part Number	Compatible Cable Size in (mm)	Weight lbs (kg)	Unit of Measure
L-SH-U12	1/2 (12)	0.7 (0.3)	Kit
L-SH-U22	7/8 (22)	1.2 (0.5)	Kit
L-SH-U33	1 1/4 (33)	1.3 (0.6)	Kit
L-SH-U42	1 5/8 (42)	1.5 (0.7)	Kit

Stackable Snap-in Hanger Kit

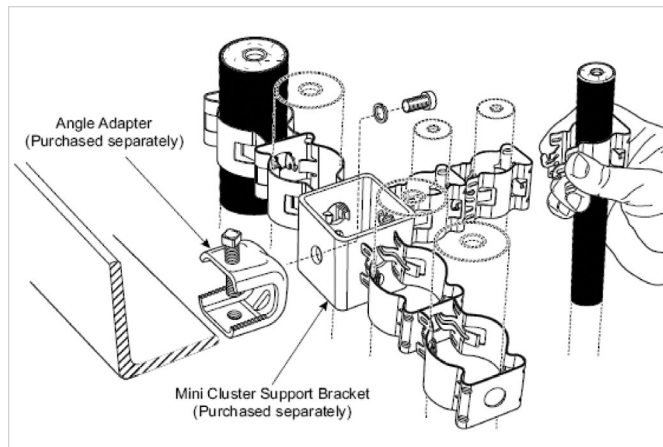

PRODUCT DESCRIPTION

The self contained design of the Stackable Snap-in Hanger eliminates the need for mounting hardware, while also providing a compact solution for supporting coaxial cable. The hanger can be stacked up to three runs high when using $\frac{3}{8}$ " , $\frac{1}{2}$ " and $\frac{7}{8}$ " coaxial cable, or two runs high when using $1\frac{1}{4}$ " and $1\frac{1}{2}$ " coaxial cable.

Each hanger accommodates one run of coaxial cable. The advanced design of the retention tabs gives the hanger the ability to absorb vibration, making the hanger resistant to pop-out. This unique design also reduces movement in the runs of coaxial cable, therefore reducing stress on the connections. Manufactured from stainless steel, this product ensures long term integrity in extreme environments including mountain tops, coastal and industrial applications.

APPLICATION

- Coax support

FEATURES

- One-piece hanger solution

BENEFITS

- Eliminates the need for mounting hardware for a simplified coax installation

SPECIFICATIONS

Compatible Cable Type	Corrugated coax
Compatible Cable Size in (mm)	$\frac{3}{8}$ (9.5) to $1\frac{1}{2}$ (42)
Material	Stainless steel
Each Kit Includes	<ul style="list-style-type: none"> 10 appropriately sized stackable snap-in hangers One (1) installation instruction sheet
Not Included (Order Separately)	Brackets

PART NUMBERS AND PHYSICAL CHARACTERISTICS

Part Number	Compatible Cable Size in (mm)	Stack Height	Weight lbs (kg)	Unit of Measure
SSHAK3812*	$\frac{3}{8}$ (9.5)	3 Runs	3.1 (1.4)	Kit
L-SH-S12	$\frac{1}{2}$ (12)	3 Runs	0.7 (0.3)	Kit
L-SH-S22	$\frac{7}{8}$ (22)	3 Runs	1.2 (0.5)	Kit
L-SH-S33	$1\frac{1}{4}$ (33)	2 Runs	1.3 (0.6)	Kit
L-SH-S42	$1\frac{1}{2}$ (42)	2 Runs	1.5 (0.7)	Kit

*Includes grommet.

Standard Hanger Kit

PRODUCT DESCRIPTION

The Standard Hangers provide a dependable solution for supporting single runs of coaxial cable in wireless systems. The pre-formed design greatly simplifies installation, allowing the coax to be quickly slipped into the Standard Hanger and then secured using the included captivated bolt. Corrosion-resistant stainless steel construction ensures long term integrity in extreme weather applications. Integrated cable grippers bite into the coax jacketing, to provide additional support in heavy wind and ice-loading conditions.

APPLICATION

- Coax support

FEATURES

- Pre-formed bolt-on single run hanger

BENEFITS

- Reduces installation time



SPECIFICATIONS

Compatible Cable Type	Corrugated coax
Compatible Cable Size in (mm)	Fits ½ (12) to 1½ (42)
Mounts to in (mm)	¾ (9.5) hardware
Material	Stainless steel
Each Kit Includes	<ul style="list-style-type: none"> 10 appropriately sized stainless steel hangers without hardware 10 captive ¼ inch (6.4 mm) slotted hex head bolts One (1) installation instruction sheet
Not Included (Order Separately)	Brackets

PART NUMBERS AND PHYSICAL CHARACTERISTICS

Part Number	Compatible Cable Size in (mm)	Weight lbs (kg)	Unit of Measure
LBHS12NH	½ (12)	0.8 (0.4)	Kit
LBHS22NH	¾ (22)	1.1 (0.5)	Kit
LBHS33NH	1¼ (33)	1.3 (0.6)	Kit
LBHS42NH	1½ (42)	1.8 (0.8)	Kit

$\lambda/4$ Wave Surge Arrestor



PRODUCT DESCRIPTION

Surge arrestors provide excellent lightning protection and outstanding RF performance. All designs have low return loss, low insertion loss and low intermodulation.

FEATURES/BENEFITS

- Outstanding RF performance
- Completely weatherproof
- Available with Type N or DIN interface
- Maintenance-free operation ($\lambda/4$ wave shorting stubs)

SPECIFICATIONS

Outer Conductor Material	Brass/silver or Su Co plated
Inner Conductor Material	Be Cu (Female)/silver or Su Co plated
Other Metal Parts Materials	Brass/nickel plated
Temperature Range °C	-40 to +100
Moisture Resistance	Waterproof
Frequency Band MHz	700-2,700

ELECTRICAL SPECIFICATIONS

Impedance (Nominal) Ω	50
V.S.W.R.	< 1.1
Insertion Loss dB	< 0.1
Intermodulation (PIM) dBc	-155
Max. Impulse Spark-Over Voltage	> 600

PART NUMBERS AND PHYSICAL CHARACTERISTICS

Part Number	Surge Arrestor Model	Frequency Band MHz	Interface Type	Unit of Measure
ATNMNF700	$\lambda/4$ wave	700-2,700	N Male/N Female	Each
ATDMDF700	$\lambda/4$ wave	700-2,700	DIN Male/DIN Female	Each
AT-NMNF-W	$\lambda/4$ wave	800-2,700	N Male/N Female	Each
AT-DMDF-W	$\lambda/4$ wave	800-2,700	DIN Male/DIN Female	Each

Gas Tube Surge Arrestor

PRODUCT DESCRIPTION

A surge arrestor is a gas discharge tube type for lightning strike protection, used most widely with $\lambda/4$ stub type systems. The surge arrestor allows for replaceable gas discharge tubes between the internal and outer conductor. When activated, this unit discharges electron pulse energy instantaneously.

FEATURES/BENEFITS

- Outstanding Broadband RF performance (up to 2,700 MHz)
- DC pass capability
- High tensional internal conductor structure
- Waterproof
- Available with 0.4375 in (11.1 mm) DIN type

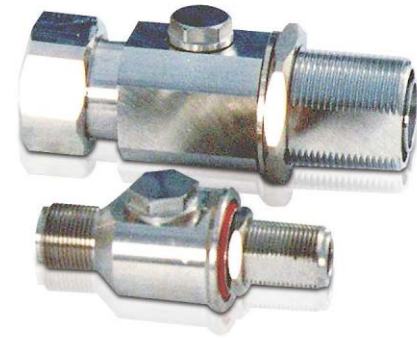

SPECIFICATIONS

Outer Conductor Material	Brass / Silver or Su Co Plated
Inner Conductor Material	Be Cu (Female) / Silver or Su Co Plated
Other Metal Parts Materials	Brass / Nickel Plated
Temperature Range °C	-40 to +100
Moisture Resistance	Waterproof
Maximum Frequency Range MHz	2,700

ELECTRICAL SPECIFICATIONS

Impedance (Nominal) Ω	50
V.S.W.R.	< 1.1
Insertion Loss dB	< 0.1
Max. Impulse Spark-Over Voltage	> 600

PART NUMBERS AND PHYSICAL CHARACTERISTICS

Part Number	Surge Arrestor Model	Interface Type	Unit of Measure
AGDMDF02	Gas Tube	DIN Male/DIN Female	Each
AG-NFNF	Gas Tube	N Female/N Female	Each

Round Adapter Kit



PRODUCT DESCRIPTION

The Round Adapter Kit provides an easy method for supporting transmission lines to small diameter pipes or poles. The round adapter kit contains ten adjustable hose clamps.

APPLICATION

- Coax hanger support

SPECIFICATIONS

Compatible Pipe/Pole Diameter in (mm)	Fits 1 (25.4) to 4 (101.6)
Material	Stainless steel
Each Kit Includes	<ul style="list-style-type: none"> 10 adjustable hose clamps One (1) installation instruction sheet
Not Included (Order Separately)	Hanger Kits Brackets

PART NUMBERS AND PHYSICAL CHARACTERISTICS

Part Number	Adjustable Diameter in (mm)	Height in (mm)	Weight lbs (kg)	Unit of Measure
RM-A100	1 to 2 (25.4 to 50.8)	0.5 (12.7)	0.8 (0.4)	Kit
RM-A300	3 to 4 (76.2 to 101.6)	0.5 (12.7)	1.2 (0.5)	Kit

Stand-Off Adapter Kit

PRODUCT DESCRIPTION

Stand-Off Adapter Kits enable hangers to be mounted to 1.5 inch (31.8 mm) or larger round adapters. The stand-off adapter is available in stainless steel to provide excellent corrosion resistance and ensure long term integrity in extreme weather applications.

APPLICATION

- Coax hanger support

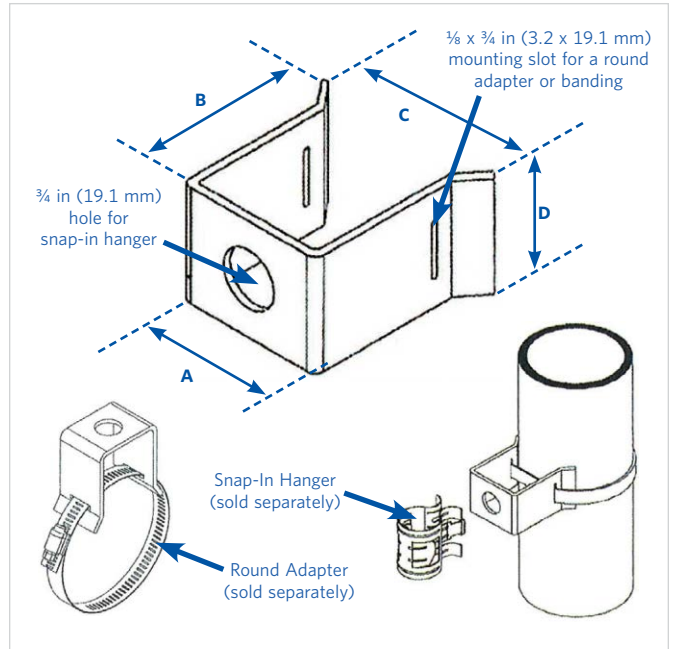

SPECIFICATIONS

Size in (mm)	A = 1.75 (44.5) B = 2.25 (57.2) C = 2.375 (60.3) D = 1.50 (38.1)
Mounts to	Round adapters 1.5 to 4.5 inch (38.1 to 114.3 mm)
Material	Stainless steel
Each Kit Includes	<ul style="list-style-type: none"> 10 stand-off adapters One (1) installation instruction sheet
Not Included (Order Separately)	Round Adapter Kit Snap-In Hanger Kit

PART NUMBERS AND PHYSICAL CHARACTERISTICS

Part Number	Compatible Round Adapter Size in (mm)	Unit of Measure
SA-SS200	1.5 to 3.5 (38.1 to 88.9)	Kit
SA-SS300	2 to 4.5 (50.8 to 114.3)	Kit

Three-Way Stand-Off Adapter Kit

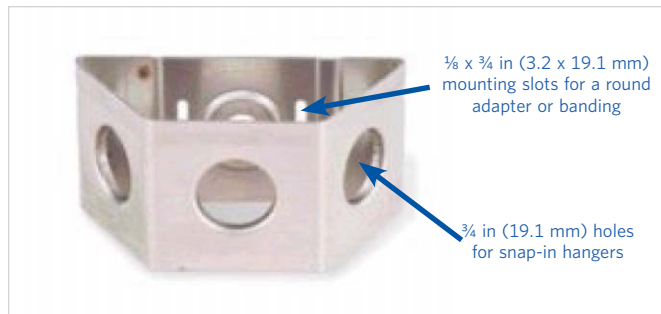

SPECIFICATIONS

Mounts to	Round adapters
Material	Stainless steel
Each Kit Includes	<ul style="list-style-type: none"> • 10 three-way stand-off adapters • One (1) installation instruction sheet
Not Included (Order Separately)	Round Adapter Kit Snap-In Hanger Kit

PART NUMBERS AND PHYSICAL CHARACTERISTICS

Part Number	Outside Length in (mm)	Outside Width in (mm)	Unit of Measure
L-SA-38	7.6 (19.3)	3.8 (98.0)	Kit

Angle Adapter Kit



SPECIFICATIONS

Compatible Solid Angle Member Thickness in (mm)	Fits up to 7/8 inch (22.2 mm)
Material	Stainless steel
Each Kit Includes	<ul style="list-style-type: none"> • 10 stainless steel angle adapters • 10 captive 3/8 inch (9.5 mm) set bolts • One (1) installation instruction sheet
Not Included (Order Separately)	Hanger Kits

PART NUMBERS AND PHYSICAL CHARACTERISTICS

Part Number	Unit of Measure
AA-SL	Kit

PRODUCT DESCRIPTION

The Three-Way Stand-Off Adapter Kit enables hangers to be mounted to round adapters. Each adapter accommodates up to three (3) snap-in hangers for supporting coaxial cable runs. The three-way stand-off adapter is available in stainless steel to provide excellent corrosion resistance and ensure long term integrity in extreme weather applications.

APPLICATION

- Coax hanger support

PRODUCT DESCRIPTION

The Angle Adapter Kit allows the installer to easily secure hangers to solid angle members or in areas where mounting holes are not easily accessible. The stainless steel bolt locks the angle adapter to standard tower members or to mounting surfaces less than 7/8 inch (22.2 mm) thick. The toothed jaw effectively secures large volumes of coax in heavy wind and ice-loading conditions.

Three (3), 3/8 inch (9.5 mm) tapped holes enable the angle adapter to accommodate hanger types which utilize 3/8 inch (9.5 mm) mounting hardware. Angle adapter kits include 10 angle adapters and 10 set bolts.

APPLICATION

- Coax hanger support

Ground Bus Bar Kit

PRODUCT DESCRIPTION

The Ground Bus Bar Kit provides a single, versatile solution to create a central ground point at your site. The ground bus bars are manufactured from ¼ inch (6.3 mm) thick solid, tinned copper, and they incorporate 26 pairs of 7/16 inch (11.1 mm) holes and 26 pairs of ¼ inch (6.4 mm) holes. By slotting one hole in each pair of 7/16 inch holes, the ground bus bar accommodates any lug hole spacing from ¾ inch (19.1 mm) to 1 inch (25.4 mm). Six (6) pairs of 7/16 inch holes are incorporated for lug connections to the ground system.

APPLICATION

- Coax protection



SPECIFICATIONS

Material

Bus bar: solid, tinned copper
 Mounting hardware: stainless steel
 Mounting brackets: galvanized steel

Each Kit Includes

- One (1) universal ground bar
¼ inch x 24 inch (6.4 mm x 0.6 m)
- One (1) mounting hardware set
- One (1) mounting bracket set
- One (1) installation instruction sheet

PART NUMBERS AND PHYSICAL CHARACTERISTICS

Part Number	Thickness in (mm)	Height in (mm)	Width in (mm)	Weight lbs (kg)	Unit of Measure
GB0424TU	0.25 (6.3)	4 (102)	24 (610)	8 (3.6)	Kit

Weather Proofing Shell



PRODUCT DESCRIPTION

The Weather Proofing Shell seals and protects connector joints from the environment. The shell also provides easy and fast installation of weather proofing on connector joints. The weather proofing shell is reusable.

APPLICATION

- Coax/connector protection

SPECIFICATIONS

Material	Long glass PP and silicon rubber
Temperature Range °F (°C)	-40 to +140 (-40 to +60)
Standards Compliance	UV Resistant UL and CL IP 68 IEC60529 ANSI C91191 RoHS-compliant

PART NUMBERS AND PHYSICAL CHARACTERISTICS

Part Number	Connector Joint Compatibility	Unit of Measure
WPSANT12D	Antenna to ½ inch (12 mm) DIN Connector	Each
WPS12158D	½ inch (12 mm) to 1½ inch (42 mm) DIN Connector	Each

Anti-Theft Hardware Kit

PRODUCT DESCRIPTION

The Anti-Theft Hardware Kit is used to prevent removal of parts easily when bolted. The kit includes four (4) anti-theft bolts and a star head allen key.

APPLICATION

- Coax protection



SPECIFICATIONS

Bolt Material	Stainless steel
Each Kit Includes	<ul style="list-style-type: none"> ▪ Four (4) anti-theft bolts measuring 3/4 inch x 1 inch (19.1 mm x 25.4 mm) ▪ One (1) star head allen key ▪ One (1) installation instruction sheet

PART NUMBERS AND PHYSICAL CHARACTERISTICS

Part Number	Unit of Measure
WATS-38	Kit

Metric Conversions

Superior Essex uses the U.S. customary system of weights and measures as well as the metric equivalents. If you need help calculating these figures, please consult the conversion charts below.

INTO METRIC CONVERSIONS			
	If You Know	Multiply By	To Get
Length	milli-inch (mil)	25.40	microns (μm)
	inches (in)	25.40	millimeters (mm)
	inches (in)	2.54	centimeters (cm)
	feet (ft)	30.48	centimeters (cm)
	yards (yd)	0.91	meters (m)
	miles (mi)	1.61	kilometers (km)
Area	sq. inches (in^2)	6.45	sq. centimeters (cm^2)
	sq. feet (ft^2)	0.09	sq. meters (m^2)
	sq. yards (yd^2)	0.84	sq. meters (m^2)
	sq. miles (mi^2)	2.59	sq. kilometers (km^2)
	acres	0.40	hectares (ha)
Mass (Weight)	ounces (oz)	28.35	grams (g)
	pounds (lbs)	0.45	kilograms (kg)
	short tons	0.91	tons (t)
Temperature	Fahrenheit ($^{\circ}\text{F}$)	Subtract 32, then multiply by 0.56	Celsius ($^{\circ}\text{C}$)
Mass per Length	pounds per 1,000 feet (lbs/kft)	1.49	kilograms per kilometers (kg/km)
Force	pounds force (lbf)	4.45	newtons (N)
	foot-pounds (ft-lbs)	1.36	newtons-meters (N-m)
	pounds force per inches (lbf/in)	1.75	newtons per centimeters (N/cm)
	pounds per sq. inches (PSI)	6.89	kiloPascals (kPa)

OUT OF METRIC CONVERSIONS			
	If You Know	Multiply By	To Get
Length	microns (μm)	0.04	milli-inch (mil)
	millimeters (mm)	0.04	inches (in)
	centimeters (cm)	0.39	inches (in)
	meters (m)	3.28	feet (ft)
	meters (m)	1.09	yards (yd)
	kilometers (km)	3,280.84	feet (ft)
	kilometers (km)	0.62	miles (mi)
Area	sq. centimeters (cm^2)	0.16	sq. inches (in^2)
	sq. meters (m^2)	1.20	sq. yards (yd^2)
	sq. kilometers (km^2)	0.39	sq. miles (mi^2)
	hectares (ha)	2.47	acres
Weight	grams (g)	0.04	ounces (oz)
	kilograms (kg)	2.20	pounds (lbs)
	tons (t)	1.10	short tons
Temperature	Celsius ($^{\circ}\text{C}$)	Multiply by 1.80, then add 32	Fahrenheit ($^{\circ}\text{F}$)
Weight per Unit Length	kilograms per kilometers (kg/km)	0.67	pounds per 1,000 feet (lbs/kft)
Force	newtons (N)	0.22	pounds force (lbf)
	newtons-meters (N-m)	0.74	foot-pounds (ft-lbs)
	newtons per centimeters (N/cm)	0.57	pounds force per inches (lbf/in)
	kilo Pascals (kPa)	0.15	pounds per sq. inches (PSI)

American Wire Gauge Sizes

The table below shows various data for copper and aluminum stranded conductors.

AMERICAN WIRE GAUGE (AWG) SIZES						
AWG/kcmil	Diameter ¹		Copper DC Resistance @ 20°C		Aluminum DC Resistance @ 20°C	
	in	mm	(Ω/kft)	(Ω/km)	(Ω/kft)	(Ω/km)
1,000	1.117	28.372	0.0106	0.0348	0.0173	0.0568
750	0.968	24.587	0.0141	0.0462	0.0231	0.0758
600	0.866	21.996	0.0177	0.0581	0.0289	0.0948
500	0.789	20.041	0.0212	0.0695	0.0035	0.1140
400	0.706	17.932	0.0264	0.0866	0.0434	0.1420
350	0.661	16.789	0.0302	0.0991	0.0495	0.1620
300	0.611	15.519	0.0353	0.1160	0.0578	0.1870
250	0.558	14.173	0.0423	0.1390	0.0694	0.2280
0000 (4/0)	0.512	13.005	0.0500	0.1640	0.0820	0.2690
000 (3/0)	0.456	11.582	0.0630	0.2070	0.1030	0.3380
00 (2/0)	0.405	10.287	0.7950	0.2610	0.1300	0.4270
0 (1/0)	0.362	9.195	0.1000	0.3280	0.1640	0.5380
1	0.322	8.179	0.1270	0.5220	0.2070	0.6790
2	0.283	7.188	0.1590	0.6590	0.2610	0.8560
4	0.225	5.715	0.2530	1.0500	0.4160	1.3600
6	0.178	4.521	0.4030	1.3200	0.6610	2.1700
8	0.142	3.607	0.6400	2.1000	1.0500	3.4400
10	0.126	3.200	1.0200	3.3500	1.6700	5.4800
12	0.113	2.870	1.6300	5.3500	2.6700	8.7600
14	0.071	1.803	2.5800	8.4600	4.2200	13.8000
16	0.0576	1.463	4.1000	13.4000	6.7100	22.0000
18	0.0456	1.158	6.5400	21.4000	10.7000	35.1000
20	0.0363	0.922	10.3000	33.8000	16.9000	55.4000
22	0.0288	0.732	16.4000	53.8000	-	-
24	0.0228	0.579	26.1000	85.6000	-	-
25	0.0179	0.455	106.2000	32.3700	-	-
26	0.0159	0.405	133.9000	40.8100	-	-
27	0.0142	0.361	168.9000	51.4700	-	-
28	0.0126	0.321	212.9000	64.9000	-	-

¹14 AWG through 1000 kcmil, Reverse Concentric Compressed Class B, ASTM B8

Standard and Cut To Length Wood Reels

STANDARD LENGTH WOOD REELS

Part Number	Cable Size in (mm)	Standard Length ft (m)	Standard Reel Dimensions			Reel Weight lbs (kg)
			Hole Size in (mm)	Flange in (mm)	Traverse in (mm)	
LHF-12D	½ (12)	1,640 (500)	3.0 (75)	33 (850)	17 (430)	99 (45)
HFSC-12D	½ (12)	1,640 (500)	3.0 (75)	33 (850)	17 (430)	99 (45)
LHF-22DU	¾ (22)	1,640 (500)	4.3 (110)	47 (1,200)	26 (650)	352 (160)
LHF-22DWH	¾ (22)	1,640 (500)	4.3 (110)	47 (1,200)	26 (650)	352 (160)
LHF-33D	1¼ (33)	1,640 (500)	4.3 (110)	69 (1,700)	30 (750)	551 (250)
LHF-42DU	1½ (42)	1,640 (500)	4.3 (110)	83 (2,100)	40 (1,020)	1,069 (485)
LHF-42DWH	1½ (42)	1,640 (500)	4.3 (110)	83 (2,100)	40 (1,020)	1,069 (485)

CUT TO LENGTH WOOD REELS

Part Number	Cable Size in (mm)	Max. Cut Length ft (m)	Standard Reel Dimensions			Reel Weight lbs (kg)
			Hole Size in (mm)	Flange in (mm)	Traverse in (mm)	
LHF-12D	½ (12)	1,000 (305)	3.1 (79)	36 (914)	26 (650)	94 (43)
HFSC-12D	½ (12)	1,000 (305)	3.1 (79)	36 (914)	26 (650)	94 (43)
LHF-22DU	¾ (22)	400 (122)	3.1 (79)	36 (914)	26 (650)	94 (43)
LHF-22DWH	¾ (22)	400 (122)	3.1 (79)	36 (914)	26 (650)	94 (43)
LHF-33D	1¼ (33)	400 (122)	3.1 (79)	67 (1,702)	30 (762)	408 (185)
LHF-42DU	1½ (42)	400 (122)	3.1 (79)	67 (1,702)	30 (762)	408 (185)
LHF-42DWH	1½ (42)	400 (122)	3.1 (79)	67 (1,702)	30 (762)	408 (185)

Note: Reels meet the ISPN Publication No.15 Guidelines for regulating wood packaging material.

Flange x Traverse x Drum (F x T x D)

F = Flange Diameter





T = Traverse (inside width between flanges)

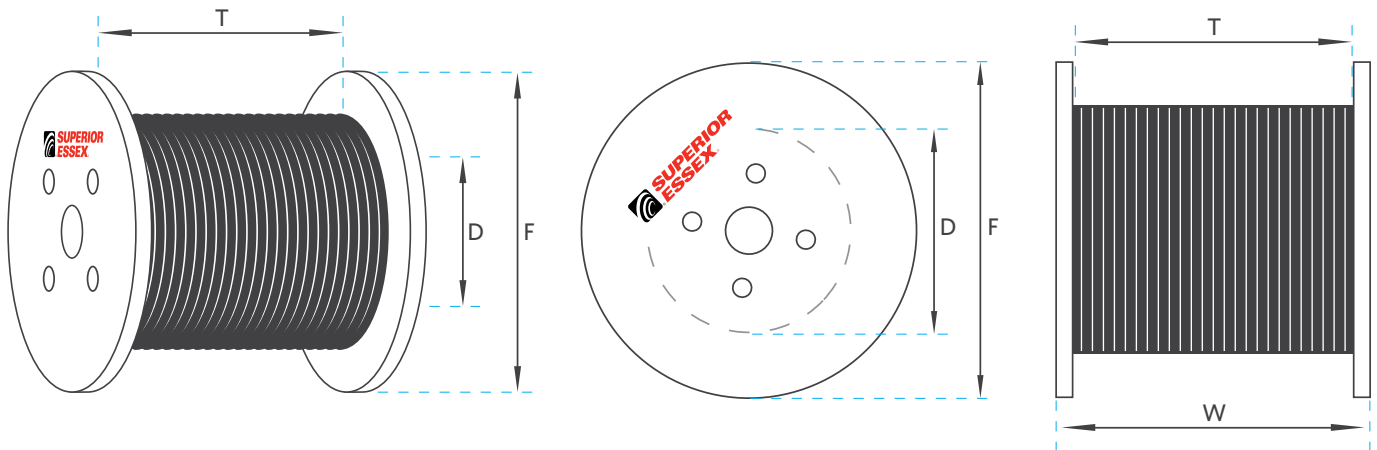



D = Drum Diameter

W = Overall Width (includes flanges)



Cable and Prep Tool Matrix

				
1/2" Riser/RF Feeder Cables	Riser Connectors	Cable Prep Drill Tool	Drill Tool Blade Replacement Kit	Flaring Tool
LHF-12DR / LHF-12D	CLH-12NM CLH-12NF CLH-12NMR CLH-12NFR	T-LHF12DR	TBK-LHFA12	TF-LFHA12
HFAC-12DR	CHFA-12NM CHFA-12NF CHFA12NMR CHFA12NFR	T-HFAC12DR		
HFSC-12DR / HFSC-12D	CHFS-12NM CHFS-12NF CHFS12NMR CHFS12NFR	T-HFSC12DR	TBK-HFSC12	TF-HFSC12

				
1/2" Plenum Cables	Plenum Connectors	Cable Prep Drill Tool	Drill Tool Blade Replacement Kit	Flaring Tool
LHF-12DP	CLHP-12NM CLHP-12NF CLHP12NMR CLHP12NFR	T-LHFA12DP	TBK-LHFA12	TF-LFHA12
HFAC-12DP	CHFAP12NM CHFAP12NF CHFAP12NMR CHFAP12NFR			
HFSC-12DP	CHFSP12NM CHFSP12NF CHFSP12NMR CHFSP12NFR	T-HFSC12DP	TBK-HFSC12	TF-HFSC12

SINGLE MODE OPTICAL FIBER

Single mode fiber (SMF) is used primarily for intermediate and long distance Outside Plant (OSP) applications that have distances between connections of up to 80 km (50 mi). It is the exceptional information carrying capacity and low-loss properties of this fiber that make it ideal for these demanding applications.

The core, or light-carrying region of the fiber, is approximately 8.3 μm in diameter. This narrows the transmission pathway allowing for only a single path, or mode, for each pulse of light traveling down the core of the fiber. The light transmission technology is laser-based for all single mode communications applications. By combining the extremely high bandwidth properties of SMF with high precision laser-based transceivers, equipment and network systems designers can create networks capable of sending simultaneous voice and data transmission well beyond 10 Gbps over many miles.

Superior Essex offers many types of single mode optical fibers for communications applications. Based on the application, Superior Essex can recommend the following SMF types.

Standard SMF offered by Superior Essex is an excellent choice for patch cords, local area network (LAN), wide area network (WAN) and metropolitan area networks (MAN). This fiber has operating wavelengths centered at 1310 nm and 1550 nm. Refer to the table on page X-4 for performance information.

Reduced Water Peak (RWP) SMF, which has been designed to have low attenuation at 1383 nm, is becoming the most commonly recommended optical fiber for all types of network applications. Standard optical fiber displays an attenuation increase at or about 1383 nm. This wavelength is known as the water-peak region and is where light is strongly absorbed by naturally occurring water-like end groups in the glass, causing high attenuation or signal loss. Specifically, hydroxyl end groups, which make up half of a water molecule, are always present at some level within the glass core and cause increased attenuation over this wavelength region. Superior Essex RWP SMF reduces this effect and allows all the wavelengths between 1300 nm and 1550 nm to be usable. This optical fiber is therefore, not only an excellent choice for traditional applications, but also for more advanced systems such as coarse wavelength division multiplexing (CWDM) and dense wavelength division multiplexing (DWDM) technologies. RWP SMF is the standard single mode optical fiber for all Superior Essex premises cables. Refer to the table on page X-4 for performance information.

Zero Water Peak SMF offers further reductions to the attenuation at 1383 nm. Attenuation improvement at 1383 nm is usually 0.03 to 0.04 dB per km. Refer to the table on page X-4 for performance information.

Non-Zero Dispersion Shifted (NZDS) fiber is used for very high data rates over very long distances (> 30 km). Because of core/cladding modifications, this fiber is more expensive than standard SMF. The advantage of NZDS is that it allows for longer distances between repeaters and therefore lowers the overall system cost for long distance networks. Refer to the table on page X-4 for performance information.

TeraFlex® bend resistant optical fiber is a SMF that complies with ITU-T G.652.D and G.657.A. The bend sensitivity of this optical fiber has been improved so that it can be coiled into a 20 mm diameter loop with ≤ 0.5 dB incurred loss at 1625 nm and ≤ 0.2 dB incurred loss at 1550 nm – five times better bending performance than leading RWP optical fibers. TeraFlex offers excellent Polarized Mode Dispersion (PMD) of ≤ 0.1 ps/ $\sqrt{\text{km}}$ per individual fiber. TeraFlex is an ideal choice for FTTP applications where small enclosures are normal and space is at a premium.

MULTIMODE OPTICAL FIBER

Multimode fiber (MMF) is identified by the physical size of the core as measured in microns (μm) and the applications for which it is typically used. MMF, the most common types having 62.5/125 μm and 50/125 μm core/cladding dimensions, are used for data communications links with the local area network (LAN). The term “multimode” refers to the way the light travels down the optical fiber. For each pulse of light launched into the optical fiber by light source (transceiver), the light signal energy travels within the optical fiber core along multiple paths, or modes. These modes travel at different speeds, resulting in the pulse of light spreading out. This effect limits the bandwidth and distances that can be supported by MMF. For this reason, MMF is used in short distance LAN applications usually less than 2 km (6,560 ft) between connections. Typical network applications include building-to-building and communications closet-to-closet backbones, intelligent highway systems and fiber-to-the-desk. MMF is the choice for these short distance applications cables because of the large core size, which allows for inexpensive connectivity, greater durability and the use of low-cost light sources.

Typically, a light emitting diode (LED), operating at a nominal wavelength of 850 nm, is used as the light source for MMF cable applications. The use of LED-based transceivers, MMF cables and inexpensive MMF connector systems have provided network designers with a relatively low-cost, high-bandwidth technology for campus-like networks. Recent technology breakthroughs in optical fiber transceiver technology have led to a new light source that extends the distance and increases the signal carrying capacity of MMF. This next-generation light source uses a vertical cavity surface emitting laser, or VCSEL (pronounced “vicsel”).

The use of VCSEL transceivers, when compared to traditional LED-based transmission systems, allows for greater distances for traditional applications such as 100 Mbps and for higher bandwidth applications such as 1 Gigabit Ethernet (1 GbE) and 10 Gigabit Ethernet (10 GbE). The VCSEL source transmits light through the center region of the optical fiber core. This has created the requirement for laser-optimized MMF. One of the most popular emerging applications for VCSEL-based LAN application is 10 GbE. By using laser-optimized optical fibers, network engineers can improve transmission performance over greater distances.

TeraGain® optical fibers are available in 62.5/125 μm and 50/125 μm fiber types. These optical fibers have been designed to provide greater data rate and distance support compared to other manufacturers’ optical fiber cables. In particular, the bandwidths of TeraGain optical fibers are greater than the standard MMF offered by other manufacturers and exceed the requirements specified in TIA-568. TeraGain optical fibers can be used with either LED or laser (VCSEL) transmission equipment. Refer to the table on page X-5 for specific performance information.

TeraGain 10G 50/125 multimode fibers are specifically optimized for 850 nm lasers (or VCSELs) that are the heart of the new 10 GbE systems specified in TIA-568. These optical fibers exceed industry specifications for both bandwidth and for differential modal dispersion. TeraGain 10G optical fibers support 10 GbE applications in three ranges: 150, 300 and 550 meters. These ranges allow engineers to cost effectively design the right optical fiber for their application requirements. Superior Essex offers TeraGain 10G/150 as its standard 50 μm MMF in all its premises optical fiber cables. Refer to the table on page X-5 for specific performance information.

Like the TeraGain 10G 50/125 multimode fibers, TeraFlex 10G multimode fibers are specifically optimized for 850 nm lasers (or VCSELs) but with the added benefit of Macrobend Resistance. These optical fibers exceed industry specifications for not only bandwidth and differential modal dispersion, but for minimum bend radii allowing use where tight bend radii are encountered. This is especially important for applications, like 40 GbE and 100 GbE, where channel margins are tight. TeraFlex 10G optical fibers support 10 GbE applications in three ranges: 150 (OM2+), 300 (OM3) and 550 (OM4) meters. Refer to the table on page X-5 for specific performance information.

Optical Fiber Selection Chart

Single Mode

Single Mode Fiber Types	Reduced Water Peak	Zero Water Peak	TeraFlex® Bend Resistant			
			G.657.A1	G.657.A2	G.657.B3	NZDS
9-Digit Part Number Designator	3	2	K	K	L	8
16-Digit Part Number Designator	10	17	13	14	15	19

Parameter	Test Method/Standard	Units	Wavelength	Cable Type									
Maximum Attenuation	ANSI/TIA-455-78-B-2002	dB/km	1310 nm	Tight Buffer	0.70	0.70	0.70	0.70	0.70	-			
				Loose Tube	0.35	0.35	0.35	0.35	0.35	-			
			1383 nm	Tight Buffer	0.70	0.70	0.70	0.70	0.70	-			
				Loose Tube	0.35	0.31	0.35	0.35	0.35	-			
			1490 nm	Tight Buffer	0.70	0.70	0.70	0.70	0.70	0.70			
				Loose Tube	0.25	0.25	0.25	0.25	0.25	0.30			
			1550 nm	Tight Buffer	0.70	0.70	0.70	0.70	0.70	0.70			
				Loose Tube	0.25	0.25	0.25	0.25	0.25	0.30			
			Typical Attenuation	ANSI/TIA-455-78-B-2002	dB/km	1310 nm	Tight Buffer	0.41	0.41	0.41	0.41	0.41	-
							Loose Tube	0.34	0.34	0.34	0.34	0.34	-
1383 nm	Tight Buffer	0.41				0.41	0.41	0.41	0.41	-			
	Loose Tube	0.33				0.31	0.31	0.31	0.31	-			
1550 nm	Tight Buffer	0.41				0.41	0.41	0.41	0.41	0.41			
	Loose Tube	0.19				0.19	0.19	0.19	0.19	0.25			

Parameter	Test Method/Standard	Units	Conditions						
Nominal Group Refractive Index	-	-	1310 nm	1.467	1.467	1.467	1.467	1.467	1.467
			1550 nm	1.468	1.468	1.468	1.468	1.468	1.468
Maximum Individual Fiber Polarization Mode Dispersion	ANSI/TIA/EIA-455-113-96	ps/v/km	-	0.2	0.2	0.2	0.2	0.2	0.2
Cable Cutoff Wavelength	ANSI/TIA-455-80-C-2003	nm	-	1260	1260	1260	1260	1260	1260
Zero Chromatic Dispersion Wavelength	ANSI/TIA-455-175-B-2003	nm	-	1300-1324	1300-1324	1300-1324	1304-1324	1304-1324	N/A
Typical Chromatic Dispersion Slope	ANSI/TIA-455-175-B-2003	ps/nm2-km	-	0.087	0.087	0.087	0.087	0.087	0.047
Proof Strength	ANSI/TIA/EIA-455-31-C-2005	kpsi GPa	On-line	100	100	100	100	100	100
			Off-line	0.69	0.69	0.69	0.69	0.69	0.69
Mode Field Diameter	ANSI/TIA-455-191-B-2003	µm	1310 nm	8.8-9.6	8.8-9.6	8.8-9.6	8.2-9.2	8.2-9.2	N/A
			1550 nm	9.9-10.9	9.9-10.9	9.9-10.9	9.1-10.1	9.1-10.1	7.8-10.0
Maximum Macrobend Attenuation Increase	ANSI/TIA-455-62-B-2003	dB	1310 nm 100 turns on 50 mm mandrel	0.05	0.05	0.01	0.01	0.01	0.05
			1550 nm 1 turn on 15 mm mandrel	-	-	-	0.40	0.40	-
			1550 nm 1 turn on 10 mm mandrel	-	-	-	0.10	0.10	-
			1550 nm 1 turn on 10 mm mandrel	-	-	-	0.10	0.10	-
Cladding Diameter	ANSI/TIA-455-176-A-2003	µm	-	125.0 ± 0.9	125.0 ± 0.9	125.0 ± 0.7	125.0 ± 0.7	125.0 ± 0.7	125.0 ± 0.7
Coating Diameter	ANSI/TIA-455-176-A-2003	micron	-	250 ± 10	250 ± 10	250 ± 10	250 ± 10	250 ± 10	250 ± 10
Maximum Core/Clad Concentricity Error	ANSI/TIA-455-176-A-2003	µm	-	0.5	0.5	0.5	0.5	0.5	0.5
Maximum Cladding Non-Circularity	ANSI/TIA-455-176-A-2003	%	-	1	1	1	0.7	0.7	0.7
Maximum Coating/Cladding Concentricity Error	ANSI/TIA-455-176-A-2003	µm	-	12	12	12	12	12	12

Data Rate	Protocol	Units	Wavelength	Maximum Transmission Distances (meters)					
1 Gbps	1000BASE-LH, 1000BASE-LH-LX	km	1310 nm	10	10	10	10	10	10
	1000BASE-ZX	km	1550 nm	70	70	70	70	70	70
10 Gbps	10GBASE-LR	km	1310 nm	25	25	25	25	25	25
	10GBASE-ER	km	1550 nm	40	40	40	40	40	40
	10GBASE-ZR	km	1550 nm	80	80	80	80	80	80
40 Gbps	40GBASE-LR4	km	1550 nm	10	10	10	10	10	10
100 Gbps	100GBASE-LR4	km	1550 nm	10	10	10	10	10	10
	100GBASE-ER4	km	1550 nm	40	40	40	40	40	40

Standards	ISO/IEC	Tight Buffer	11801: OS1	11801: OS1	11801: OS1	11801: OS1	11801: OS1	-
		Loose Tube	24702: OS2	24702: OS2	24702: OS2	24702: OS2	24702: OS2	-
Telcordia	GR-20-CORE							
	ITU-T	G.652.D	G.652.D	G.652.D G.657.A1	G.652.D G.657.A2	G.652.D G.657.B3	G.655.C, E G.656	
TIA-492	CAAB	CAAB	CAAB	CAAB	CAAB	CAAB	N/A	
IEC 60793-2-50 Type	B1.3	B1.3	B1.3	B1.3	B1.3	B1.3	-	
ANSI/ICEA	Tight Buffer	S-83-596						
	Loose Tube	S-87-640						
RUS	Loose Tube	PE-90						

Optical Fiber Selection Chart

Multimode

TABLE OF CONTENTS

RF FEEDER

IN-BUILDING WIRELESS

ACCESSORIES

TECH INFO

INDEX

Multimode Fiber Types	TeraGain® 62.5/125	TeraGain 50/125	TeraGain Laser Optimized 50/125			TeraFlex® Bend Resistant Laser Optimized 50/125		
			10G/150	10G/300	10G/550	10G/150	10G/300	10G/550
9-Digit Part Number Designator	6	5	A	B	F	M	N	P
16-Digit Part Number Designator	23	21	27	29	31	28	30	32

Cable Performance	Parameter	Test Method/Standard	Units	Wavelength	Cable Type									
	Maximum Attenuation		TIA/EIA-455-78	dB/km	850 nm	Tight Buffer/ Loose Tube	3.5	3.5	3.5	3.5	3.5	3.5	3.5	3.5
TIA/EIA-455-78			dB/km	1300 nm	Tight Buffer/ Loose Tube	1.5	1.5	1.5	1.5	1.5	1.5	1.5	1.5	
Typical Attenuation		TIA/EIA-455-78	dB/km	850 nm	Tight Buffer	3.0	3.0	3.0	3.0	3.0	3.0	3.0	3.0	
					Loose Tube	2.7	2.2	2.2	2.2	2.2	2.2	2.2	2.2	
		TIA/EIA-455-78	dB/km	1300 nm	Tight Buffer	1.0	1.0	1.0	1.0	1.0	1.0	1.0	1.0	1.0
					Loose Tube	0.6	0.5	0.5	0.5	0.5	0.5	0.5	0.5	0.5

Fiber Performance	Parameter	Test Method/Standard	Units	Conditions									
	Numerical Aperture	ANSI/TIA-455-177-B-2003	-	-	-	0.275 ± 0.015	0.200 ± 0.015	0.200 ± 0.015	0.200 ± 0.015	0.200 ± 0.015	0.200 ± 0.015	0.200 ± 0.015	0.200 ± 0.015
Nominal Group Refractive Index	OTDR	-	-	850 nm	1.496	1.483	1.483	1.483	1.483	1.483	1.483	1.483	
				1300 nm	1.491	1.479	1.479	1.479	1.479	1.479	1.479	1.479	
Macrobend Attenuation Change	ANSI/TIA-455-62-B-2003	dB	-	100 turns on 75 mm Mandrel	850 nm	≤ 0.5	≤ 0.5	≤ 0.5	≤ 0.5	≤ 0.5	≤ 0.5	≤ 0.5	≤ 0.5
				1300 nm	≤ 0.5	≤ 0.5	≤ 0.5	≤ 0.5	≤ 0.5	≤ 0.5	≤ 0.5	≤ 0.5	
				2 turns on 30 mm Mandrel	850 nm	-	-	-	-	-	≤ 0.1	≤ 0.1	≤ 0.1
				1300 nm	-	-	-	-	-	≤ 0.3	≤ 0.3	≤ 0.3	
				2 turns on 15 mm Mandrel	850 nm	-	-	-	-	-	≤ 0.2	≤ 0.2	≤ 0.2
				1300 nm	-	-	-	-	-	≤ 0.5	≤ 0.5	≤ 0.5	
Proof Strength	TIA/EIA-455-31	-	kpsi	On-line	100	100	100	100	100	100	100	100	
			GPa	On-line	0.69	0.69	0.69	0.69	0.69	0.69	0.69	0.69	
Cladding Diameter	ANSI/TIA-455-176-A-2003	micron	-	-	125 ± 2	125 ± 2	125 ± 2	125 ± 2	125 ± 2	125 ± 2	125 ± 2	125 ± 2	
Coating Diameter	ANSI/TIA-455-176-A-2003	micron	-	-	250 ± 10	250 ± 10	250 ± 10	250 ± 10	250 ± 10	250 ± 10	250 ± 10	250 ± 10	
Core/Clad Concentricity Error	ANSI/TIA-455-176-A-2003	microns	-	-	1.5	1.5	1.5	1.5	1.5	1.5	1.5	1.5	
Cladding Non-Circularity	ANSI/TIA-455-176-A-2003	%	-	-	1.5%	1.5%	1.5%	1.5%	1.5%	1.5%	1.5%	1.5%	
Coating/Clad Concentricity Error	ANSI/TIA-455-176-A-2003	microns	-	-	12 μm	12 μm	12 μm	12 μm	12 μm	12 μm	12 μm	12 μm	
Minimum Bandwidth: Overfilled Launch	TIA/EIA-455-124-2000	MHz-km	-	850 nm	220	500	700	1,500	3,500	700	1,500	3,500	
				1300 nm	600	500	500	500	500	500	500	500	
Minimum Bandwidth: Laser Effective Modal Bandwidth	TIA-455-220-A	MHz-km	-	850 nm	N/A	N/A	950	2,000	4,700	950	2,000	4,700	
				1300 nm	N/A	N/A	500	500	500	500	500	500	

Guaranteed Supportable Ethernet Distances	Data Rate	Protocol	Units	Wavelength	Maximum Transmission Distances (meters)							
	10 Mbps	10BASE-FL	meters	850 nm	1,250	1,250	1,250	1,250	1,250	1,250	1,250	1,250
500					750	1,000	1,000	1,000	1,000	1,000	1,000	1,000
100 Mbps	100BASE-SX	meters	850 nm	2,000	2,000	2,000	2,000	2,000	2,000	2,000	2,000	2,000
				100BASE-FX	meters	1300 nm	300	750	1,000	1,000	1,040	1,000
1 Gbps	1000BASE-SX	meters	850 nm	600*	600*	600	600	600	600	600	600	600
				1000BASE-LX	meters	1300 nm	35	82	150	300	550	150
10 Gbps	10GBASE-SR	meters	850 nm	300	300	300	300	300	300	300	300	300
				10GBASE-LRM	meters	1300 nm	-	-	-	100	125	-
40 Gbps	40GBASE-SR4	meters	850 nm	-	-	-	100	125	-	100	125	
100 Gbps	100GBASE-SR10	meters	850 nm	-	-	-	100	125	-	100	125	

*Mode conditioning patch cord required

Standards	ISO/IEC 11801	OM1	OM2	OM2	OM3	OM4	OM2	OM3	OM4		
	Telcordia	GR-20-CORE									
	ITU-T	G.651.1									
	TIA-492	AAAA-A	AAAB	AAAB	AAAC-A	AAAD	AAAB-A	AAAC-B	AAAD		
	IEC 60793-2-10 Type	A1b	A1a.1	A1a.1	A1a.2	A1a.3	A1a.1	A1a.2	A1a.3		
	ANSI/CEA	Tight Buffer	S-83-596								
		Loose Tube	S-87-640								

Terms and Conditions of Sale

For Communication and Energy Cable, Wire and Connectivity Products

1. GENERAL

These Terms and Conditions of Sale (the "Terms") govern Buyer's purchase of any communication and energy cable, wire and connectivity products (the "Products") from Superior Essex International LP ("Seller"). Buyer's purchase of the Products is limited to the terms and conditions contained herein. If these Terms are first tendered to Buyer before Buyer tenders a purchase order or similar document to Seller, these Terms are in lieu of any terms later submitted by Buyer and Seller rejects all additional or different terms and conditions of Buyer, whether confirmatory or otherwise. If Seller tenders these terms after the tender by Buyer of other terms, whether as part of a purchase order or otherwise, then Seller's acceptance of any offer by Buyer associated with Buyer's terms is expressly conditioned upon Buyer's acceptance of these Terms exclusively and to the exclusion of any proffered Buyer terms or conditions, regardless of whether these Terms contain any terms additional to, or different from, any terms proffered by Buyer. Buyer's performance, or acceptance of, or payment for, any products from Seller will constitute Buyer's acceptance of these Terms exclusively. If there is an executed written sales agreement or quotation in effect between the parties (a "Sales Agreement"), these Terms form a part thereof. Waiver by Seller of any breach, remedy or provision of these Terms shall not be construed to be a waiver of any succeeding breach or any other provision or legal remedy of Seller. The section headings of these Terms are for ease of reference only and shall not be admissible in any action to alter, modify or interpret the contents of any section hereof. The International Convention on the Sale of Goods shall have no application to any sales of Products hereunder.

2. PRICE, CHARGES AND PAYMENT

Orders are not binding upon Seller until accepted by Seller in its sole discretion. No order submitted by Buyer shall be deemed accepted by Seller unless and until either confirmed in writing by Seller or by delivery of the Product specified in the order, and then only on these Terms. Seller may modify Buyer's order where necessary as follows: (a) substituting the latest or correct part number or part description for the part number or part description set forth on the order; (b) substituting Seller's prices in effect as applicable to the order; (c) substituting an estimated delivery schedule which is reasonable (considering Seller's stock availability and lead time); and (d) correcting any stenographical or typographical error. The price of any Product sold to Buyer shall be Seller's price in effect at time of order entry. Prices for energy cable products will be adjusted at the time of shipment to reflect the closing COMEX metal price on the date prior to the ship date. Seller's current ancillary charges apply as applicable to the order such as parallel, cut, wood lagging, gas pressure, pulling eye and lift gate charges.

Fees for and relating to the Products are subject to adjustment in the event there are cost increases created by circumstances such as, but not limited to, changes in government energy policies, fuel and energy increases, metal premium or metal processing charges, chemical or material price increases, material and supply shortages, transportation and shipping costs. Any accepted order requiring special manufacturing processes, inspection, specified weight, packaging, test results, certification, etc., is subject to additional charges.

Unless otherwise agreed to by Seller in writing, Buyer agrees to pay all amounts due to Seller within thirty (30) days from the date of invoice. Overdue payments shall bear interest and service charges from the due date until paid at a rate of 1.5% (015) per month or the maximum legal rate, whichever is less, and any collection costs of Seller. FAILURE TO PAY ANY AMOUNT WHEN DUE VOIDS ALL WARRANTIES.

Credit is extended at the sole discretion of Seller. If credit has been extended, the amount of credit may be changed or credit withdrawn by Seller at any time, in its sole discretion. If a cash discount is stipulated, it is subject to Buyer's entire account being current. Any discounts given to Buyer by Seller in relation to the price of the Products are conditional upon payment for the Products being made strictly in accordance with the Sales Agreement and these Terms and to Buyer's entire account for all products purchased from Seller being current.

3. DELIVERY, TITLE, RISK OF LOSS, AND SHIPPING OF PRODUCTS

Title to and risk of loss of the Products shall pass to Buyer upon tender of such Products to Buyer at Seller's factory or a common carrier. Unless otherwise agreed by Seller in writing, shipping terms shall be Ex Works (Incoterms 2010) Seller's factory or warehouse. Seller's weights shall govern provisional and final settlement. Any shipping date provided by Seller is the Seller's best estimate and will not operate to bind Seller to ship or make deliveries on such date. All shipments shall be subject to Seller's then current shipment terms, including its Freight Policies, Freight Damage Policies, and minimum order values.

Buyer must thoroughly inspect the Products at the time of receipt for signs of damage, discrepancies or a shortage. Inspections of the Products at the time of delivery shall be commenced in the presence of the carrier's driver and Buyer shall note on the freight bill any shortages, discrepancies or damages of any Product received on the carrier's receipt. If concealed loss or damage is discovered, Buyer must report it to the carrier within 15 days from the date of receipt.

4. LIMITED WARRANTIES AND DISCLAIMERS

Seller warrants to Buyer that at the time of delivery the Products will conform substantially to Seller's specifications identified in the applicable Product Data Sheets ("Specifications"). As Buyer's sole and exclusive remedy and Seller's entire liability for any breach of the foregoing warranty, Seller will, at its sole option and expense, either refund the purchase price paid, repair or replace the Product which fails to meet this warranty upon return of the nonconforming Product; provided, Buyer notifies Seller of noncompliance in writing:

- (i) for Fiber to the Premises Closure Products ("FTTP"), within ten (10) years of delivery for external plastic and metal parts of the closure and within one (1) year of delivery for internal fiber splice, attachment and management components; and
- (ii) for all other Products, within one (1) year of delivery of such Product.

Transportation charges to and from Seller's location for the return of all nonconforming Products to Seller and their re-shipment to Buyer and the risk of loss thereof will be borne by Seller. Buyer shall use Seller's designated carrier for all re-shipments. These warranties do not apply to any Product that was not properly stored or handled by the Buyer, that was repaired or altered or was otherwise subject to abuse, neglect or improper use by Buyer or a third party, or that has any stage of processing performed on it which causes the defect. EXCEPT WITH RESPECT TO THE SPECIFIC WARRANTIES SET FORTH IN THIS SECTION 4 OF THESE TERMS, SELLER MAKES NO OTHER WARRANTIES WHATSOEVER, EXPRESS OR IMPLIED, REGARDING THE PRODUCTS OR PERFORMANCE OF ITS OBLIGATIONS HEREUNDER, AND SPECIFICALLY DISCLAIMS ANY WARRANTIES OF MERCHANTABILITY OR FITNESS FOR A PARTICULAR PURPOSE. Without limitation, under no circumstances shall Seller be liable for any costs associated with reworking, re-manufacturing or scrapping goods in which defective Product supplied by Seller was incorporated, for any costs associated with production stoppages, machinery breakdown or recall campaigns, or for any troubleshooting, administrative or engineering charges.

5. CLAIMS OF PATENT INFRINGEMENT

Seller shall conduct, at its own expense, the entire defense of any claim, suit, action or other proceedings ("Claim") brought against Buyer by a third party alleging that any Product manufactured by Seller infringes upon any United States patent of any third party, provided, however: (i) Seller receives prompt written notice of the Claim; (ii) Seller has full control of the defense and all related settlement negotiations; (iii) the Products are made according to a specification or design furnished by Seller, or if a process patent is involved, the process performed by the Products are recommended in writing by Seller; and (iv) Buyer provides Seller with all necessary assistance, information and authority to perform the defense and negotiate settlement thereof. Provided all four of the foregoing conditions are met, Seller shall, at its own expense, either settle said Claim or shall pay all damages (excluding incidental, consequential, statutory, or punitive damages) and costs awarded by the court therein. If the use or resale of such Products is finally enjoined, Seller shall, at Seller's option, procure for Buyer the right to use or resell the Products, replace them with equivalent non-infringing Products, modify them so they become non-infringing but equivalent, or remove them and refund the purchase price (less a reasonable allowance for use, damage or obsolescence). Buyer shall indemnify and hold Seller harmless from all Claims based upon (i) the use of a Product customized for Buyer based on Buyer's ideas, specifications or designs, (ii) the performance of a process performed by the Products not recommended in writing by Seller, or (iii) the use or sale of the Products delivered hereunder in combination with other products not delivered to Buyer by Seller.

6. EXCUSABLE PERFORMANCE

Seller is excused from performing any of its obligations under these Terms, any order or Sales Agreement if its performance is prevented, hindered or delayed by delays of suppliers, acts of God, nature, governments or their agencies, terrorism, war or

sabotage, compliance in good faith with any applicable foreign or domestic governmental regulation or order (whether or not it proves to be invalid), fires, riots, inability to supply or obtain products, materials, raw materials, supplies, fuel or utilities from normal sources of supply, labor disputes, work stoppages, lockouts, delays in transportation, earthquakes, floods, storms or other severe weather conditions, power shortages or power failures or any other events or circumstances beyond Seller's reasonable control (an "Event"). To the extent an Event delays Seller's performance, such performance shall be extended for as many days beyond the due date until the delay concludes; provided, however, if Seller is unable to perform any of its obligations under any order due to an Event for more than thirty (30) days, it may in its sole option terminate, without liability or penalty, any Sales Agreement, order or obligation in whole or in part. It is expressly understood that the Seller has available a limited source for the materials used by Seller in the manufacture of the Products. If there is an interference, limitation or cessation of any material from Seller's source of supply for any reason, Buyer agrees to relieve the Seller temporarily, proportionately, or permanently of liability under these Terms or any Sales Agreement or order, depending upon whether the interruption of the source of supply is a temporary interruption, a reduced delivery of materials, or a permanent cessation of supply. In the event there is a Product shortage pursuant to this section, Seller may ration and distribute such Products as it deems appropriate.

7. TAXES AND EXPORTS

Any and all taxes (not including any U.S. income or excess profit taxes attributable to Seller) which may be imposed by any taxing authority, arising from the sale, delivery or use of the Products and for which Seller may be held responsible for collection or payment, either on its own behalf or that of Buyer, shall be paid by Buyer to Seller upon Seller's demand. Export orders are subject to applicable export regulations and requirements. Buyer disclaims in favor of Seller any right or interest in, the drawback of duty, taxes or surcharges paid on imported material contained in the Products.

8. FINANCIAL RESPONSIBILITY OF BUYER

Buyer's solvency is a condition of Seller's performance and Seller may, at any time, in its sole discretion for credit reasons (including a good faith belief that a current or future payment is or may be impaired) or because of Buyer's breach of this or any other agreement with Seller, suspend or change credit terms, fix a limit on credit, require progress payments, demand payment in full of any outstanding balance, withhold shipments, demand COD or request other assurances of payment, cancel or terminate any order or agreement or repossess all Products previously delivered, which Products shall become the absolute property of Seller subject to credit therefore. Buyer grants to Seller a security interest in Products delivered hereunder to secure Buyer's obligations under these Terms and any Sales Agreement and grants to Seller the right to execute, deliver, and/or file any financing statement or do any other thing reasonably necessary to perfect Seller's security interest. Notwithstanding any other provision of these Terms, Seller reserves the right in its absolute discretion from time to time to require payment in full of the price of the Products before delivery of all or any of the Products.

Seller may terminate any order or Sales Agreement by written notice to Buyer if (i) a receiver or trustee is appointed for any of Buyer's property; (ii) Buyer is adjudicated or voluntarily becomes bankrupt or a debtor under any bankruptcy, dissolution or reorganization laws or similar law; (iii) Buyer becomes insolvent or makes an assignment for the benefit of creditors; (iv) an execution is issued pursuant to a judgment rendered against Buyer; or (v) Buyer is unable or refuses to make payment to Seller. If any order or Sales Agreement is terminated by Seller pursuant to this section, Seller shall be relieved of any further obligation to Buyer and Buyer shall reimburse Seller for its termination costs and expenses and a reasonable allowance for profit.

In addition to any right of set off or recoupment provided by law, Buyer agrees that all its accounts with Seller will be administered on a net settlement basis and that Seller may set off debits and credits, including Seller's attorney fees and costs of enforcement, against any of Buyer's accounts regardless of the basis for such debits and credits and without advance notice. In this section, "Seller" includes Seller's parent, subsidiaries and affiliates, and "Buyer" includes Buyer's parent, subsidiaries and affiliates.

9. CANCELLATIONS AND RETURNS

All orders accepted by Seller are non-cancelable unless (i) such order is cancelled in writing thirty (30) days prior to the scheduled ship date and (ii) the Products ordered were not manufactured as special or customized items. A cancellation fee of 10% of the quoted price shall apply. If paid for, cancelled Products may be returned for credit only. Return of any Product must be authorized by Seller. Seller will provide Buyer a Return Material Authorization number which must be shown on the returned Product and associated shipping documents. Standard stock items are returnable at invoice price less a 20% restocking charge, freight prepaid by Buyer to the plant of manufacture or Seller's designated location. Non-stock items and/or special items are not subject to return. All material must be returned to Seller undamaged and in the original packaging.

10. CHANGES — PROCESS, MATERIAL AND PRODUCT DESIGN

Seller continually develops and uses new processes, materials and product designs in an effort to improve its Products, while maintaining conformity to the Specifications. If Buyer's applications of the Products rely upon any performance, dimensional or constant criteria other than as required by the applicable Specifications, Buyer must conduct regular testing or evaluation of those specific Products. Seller makes no warranty or representation of any nature that any material shipped conforms to any material of like product description as may have previously been delivered to Buyer.

11. LIMITATION OF LIABILITY

IN NO EVENT WILL SELLER BE LIABLE TO BUYER FOR ANY INDIRECT, INCIDENTAL, SPECIAL, PUNITIVE, DELAY, OR CONSEQUENTIAL DAMAGES, INCLUDING WITHOUT LIMITATION, LOSS OF DIRECT OR INDIRECT PROFITS, REVENUE, OR USE, WHETHER ARISING IN CONTRACT, TORT, OR OTHERWISE, EVEN IF BUYER OR ANY OTHER PARTY HAS BEEN ADVISED OF THE POSSIBILITY OF SUCH DAMAGES. IN NO EVENT WILL SELLER'S AGGREGATE LIABILITY TO BUYER EXCEED ALL AMOUNTS ACTUALLY PAID BY BUYER TO SELLER. THESE LIMITATIONS SHALL APPLY NOTWITHSTANDING ANY FAILURE OF ESSENTIAL PURPOSE OF THE LIMITED REMEDY SET FORTH IN SECTION 4.

12. CONFIDENTIALITY

Buyer will not disclose to third persons any proprietary or confidential information of Seller concerning its business and operations, including without limitation, pricing information, for a period of five (5) years from the date such confidential information was learned or for confidential information meeting the definition of "trade secret" under applicable law, until such information is no longer a "trade secret." The obligations of confidentiality in this Section 12 do not apply to Confidential Information to the extent that the Confidential Information becomes readily ascertainable by proper means by the public other than through breach of this Section 12 by Buyer.

13. CHOICE OF LAW

These Terms and all accepted orders shall be construed in accordance with the laws of the State of Georgia, United States of America without regard to its conflict of law principles. Buyer agrees that any and all disputes with Seller, including contract and tort claims, shall be resolved in the state and federal courts situated in Georgia, and that these courts shall have the exclusive jurisdiction over all such disputes and Buyer consents to the personal jurisdiction in these courts. Any action brought by Buyer against Seller shall be within one (1) year after the cause of action arises or it shall be deemed forever waived.

14. ADDITIONAL TERMS

The provisions of these Terms and the Sales Agreement, if any, constitute the entire agreement between Buyer and Seller with respect to the matter contained herein and supersedes any prior oral or written communications, understanding, representations, proposals or agreements with respect to such subject matter. Seller may revise these Terms from time to time. These Terms may not be amended or modified by the Buyer except upon the execution of a written agreement signed by both parties indicating an intent to modify these Terms. Neither Buyer nor Seller may assign any of its rights or obligations hereunder or under any order; provided, however, that Seller shall be permitted to assign any of its rights or obligations under these Terms, Sales Agreement or any order in connection with the sale or transfer of all or substantially all of its business, whether by merger, reorganization, consolidation, transfer of assets, transfer of equity interests, or otherwise. If any provision of these Terms or a Sale Agreement is invalid, unenforceable or in conflict with any law, such provision shall be deemed severed from these Terms and/or the Sale Agreement and the validity of the remainder of these Terms and/or the Sale Agreement shall not be affected thereby. The provisions of these Terms that by their nature are reasonably intended by the parties to survive the expiration or termination of the Terms or any accepted order, including without limitation sections 4, 5, 11, 12, 13 and this section 14, shall survive the expiration or termination of the Terms or any accepted order.

Part Number Index

Part Number	Page	Part Number	Page	Part Number	Page	Part Number	Page	Part Number	Page
53012K01Q	D-6	CHFSP12NF	D-26	HFAC-12DP	D-19	JR122NFRF	D-20	L-HG-12L	D-31
53024K01Q	D-6	CHFSP12NMR	D-26	HFAC-12DR	D-18	JR122NMNF	D-20	L-HG-12	D-31
53048J01Q	D-6	CHFSP12NM	D-26	HFSC-12DP	D-17	JR122NMNM	D-20	L-HG-22L	D-31
AA-SL	D-40	CLH-12DFR	D-8	HFSC-12DR	D-16	JR122NMRF	D-20	L-HG-22	D-31
AGDMDF02	D-37	CLH-12DF	D-22	HFSC-12D	D-5	JR122NMRM	D-20	L-HG-33L	D-31
AG-NFNF	D-37	CLH-12DF	D-8	J12-1DMDM	D-7	JR123NFNF	D-20	L-HG-33	D-31
ATDMDF700	D-36	CLH-12DMR	D-22	J12-1NMNM	D-7	JR123NFRF	D-20	L-HG-42L	D-31
AT-DMDF-W	D-36	CLH-12DMR	D-8	J12-2DMDM	D-7	JR123NMNF	D-20	L-HG-42	D-31
ATNMNF700	D-36	CLH-12DM	D-22	J12-2NMNM	D-7	JR123NMNM	D-20	L-SA-38	D-40
AT-NMNF-W	D-36	CLH-12DM	D-8	J12-3DMDM	D-7	JR123NMRF	D-20	L-SH-S12	D-34
CHAP12NMR	D-27	CLH-12NFR	D-10	J12-3NMNMR	D-7	JR123NMRM	D-20	L-SH-S22	D-34
CHFA-12DF	D-24	CLH-12NFR	D-25	J12-3NMNM	D-7	LBA-12-1A	D-29	L-SH-S33	D-34
CHFA-12DMR	D-24	CLH-12NF	D-10	J12-4DMDM	D-7	LBA-12-2A	D-29	L-SH-S42	D-34
CHFA-12DM	D-24	CLH-12NF	D-25	J12-4NMNM	D-7	LBA-12-3A	D-29	L-SH-U12	D-33
CHFA12NFR	D-27	CLH-12NMR	D-10	J12-5DMDF	D-7	LBA-12-4A	D-29	L-SH-U22	D-33
CHFA-12NF	D-27	CLH-12NMR	D-25	J12-5DMDM	D-7	LBA-12-5A	D-29	L-SH-U33	D-33
CHFA12NMR	D-27	CLH-12NM	D-10	J12-5NMNM	D-7	LBA-22-1A	D-29	L-SH-U42	D-33
CHFA-12NM	D-27	CLH-12NM	D-25	J12-6NMNMR	D-7	LBA-22-2A	D-29	L-WK-U	D-30
CHFAP12DF	D-24	CLH-22DF	D-8	JP121NFNF	D-21	LBA-22-3A	D-29	RM-A100	D-38
CHFAP12DMR	D-24	CLH-22DM	D-8	JP121NFRF	D-21	LBA-22-4A	D-29	RM-A300	D-38
CHFAP12DM	D-24	CLH-22NF	D-10	JP121NMNF	D-21	LBA-33-1A	D-29	SA-SS200	D-39
CHFAP12NFR	D-27	CLH-22NM	D-10	JP121NMNM	D-21	LBA-42-1A	D-29	SA-SS300	D-39
CHFAP12NF	D-27	CLH-33DF	D-8	JP121NMRF	D-21	LBA-57-1A	D-29	SSHAK3812*	D-34
CHFAP12NM	D-27	CLH-33DM	D-8	JP121NMRM	D-21	LBHS12NH	D-35	TBK-HFSC12	D-28
CHFS12DFR	D-9	CLH-33NF	D-10	JP122NFNF	D-21	LBHS22NH	D-35	TBK-LHFA12	D-28
CHFS-12DF	D-23	CLH-33NM	D-10	JP122NFRF	D-21	LBHS33NH	D-35	TF-HFSC12	D-28
CHFS-12DF	D-9	CLH-42DF	D-8	JP122NMNF	D-21	LBHS42NH	D-35	TF-LHFA12	D-28
CHFS12DMR	D-23	CLH-42DM	D-8	JP122NMNM	D-21	L-CT-12DS	D-28	T-HFAC12DR	D-28
CHFS12DMR	D-9	CLH-42NF	D-10	JP122NMRF	D-21	L-CT-12D	D-28	T-HFSC12DP	D-28
CHFS-12DM	D-23	CLH-42NM	D-10	JP122NMRM	D-21	L-CT-22D	D-28	T-HFSC12DR	D-28
CHFS-12DM	D-9	CLHP-12DF	D-22	JP123NFNF	D-21	L-FT-42D	D-28	T-LHF12DR	D-28
CHFS12NFR	D-11	CLHP12DMR	D-22	JP123NFRF	D-21	L-GK-C12	D-32	T-LHFA12DP	D-28
CHFS12NFR	D-26	CLHP-12DM	D-22	JP123NMNF	D-21	L-GK-C22	D-32	WATS-38	D-43
CHFS-12NF	D-11	CLHP12NFR	D-25	JP123NMNM	D-21	L-GK-C33	D-32	WPS12158D	D-42
CHFS-12NF	D-26	CLHP-12NF	D-25	JP123NMRF	D-21	L-GK-C42	D-32	WPSANT12D	D-42
CHFS12NMR	D-11	CLHP12NMR	D-25	JP123NMRM	D-21	LHF-12DP	D-15		
CHFS12NMR	D-26	CLHP12NM	D-25	JR121NFRF	D-20	LHF-12DR	D-14		
CHFS-12NM	D-11	F2C2-012U13-6991-CE5	D-13	JR121NFRF	D-20	LHF-12D	D-2		
CHFS-12NM	D-26	F4C2-012U13-6991-CE5	D-12	JR121NMNF	D-20	LHF-22DU	D-4		
CHFSP12DF	D-23	GB0424TU	D-41	JR121NMNM	D-20	LHF-22DWH	D-3		
CHFSP12DMR	D-23	GM012K011	D-6	JR121NMRF	D-20	LHF-33D	D-2		
CHFSP12DM	D-23	GM012K111	D-6	JR121NMRM	D-20	LHF-42DUF	D-4		
CHFSP12NFR	D-26	GM012K221	D-6	JR122NFNF	D-20	LHF-42DWH	D-3		



6120 Powers Ferry Road, Suite 150
Atlanta, Georgia 30339

P 770.657.6000
T 800.551.8948
F 877.291.7919

SuperiorEssex.com