

Wiring Duct & Wiring Trough

In this section...



Wiring Duct & Wiring Trough

Ty-Duct® Wiring Duct	C-68-C-77
Wiring Duct Tools and Accessories	C-78-C-81
Wiring Duct Technical Information	C-82-C-86
Carlon® Wiring Trough and Accessories	C-87-C-89
Wiring Trough Technical Information.....	C-90-C-92

Ty-Duct® Wiring Duct

Ty-Duct® — The versatile configurations you need for routing and concealing wiring!

Thomas & Betts' innovative new Ty-Duct products offer a total solution for routing and concealing wiring in control panels. Many different sizes are available to accommodate anything from the smallest wallmount panel to the larger integrated systems!

Here are some of the impressive features incorporated into our wiring duct solutions.

Ty-Duct® Features

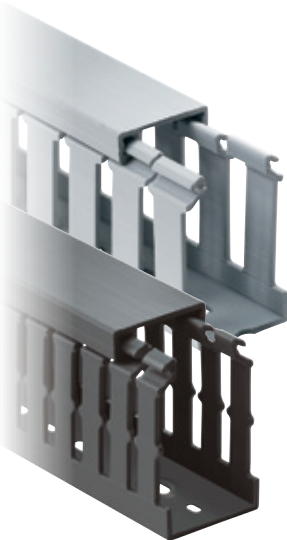

- Available in Wide and Narrow Slot versions to meet your capacity and flexibility needs
- Widths from .75" to 6" and depths from 1" to 5"
- Complete selection of accessories and tools for installation
- Lead-free construction
- Lightweight halogen-free material available for Wide Slot Wiring Duct



Ty-Duct® Certifications

- UL® Recognized Continuous-Use Temperature —
122° F (50° C) for Standard PVC Material
203° F (95° C) for Halogen-Free Material
- UL® 94 Flammability —
Rating of V-0 for Standard PVC Material
Rating of V-1 for Halogen-Free Material
- Conforms with NFPA 79-2011 Section 13.3.1
Requirement for Flame-Retardant Material
- CE compliant for European shipping
- CSA Certified
- RoHS Certified



Available in 2 Colors

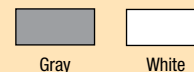

Ty-Duct® Wiring Duct

Ty-Duct®

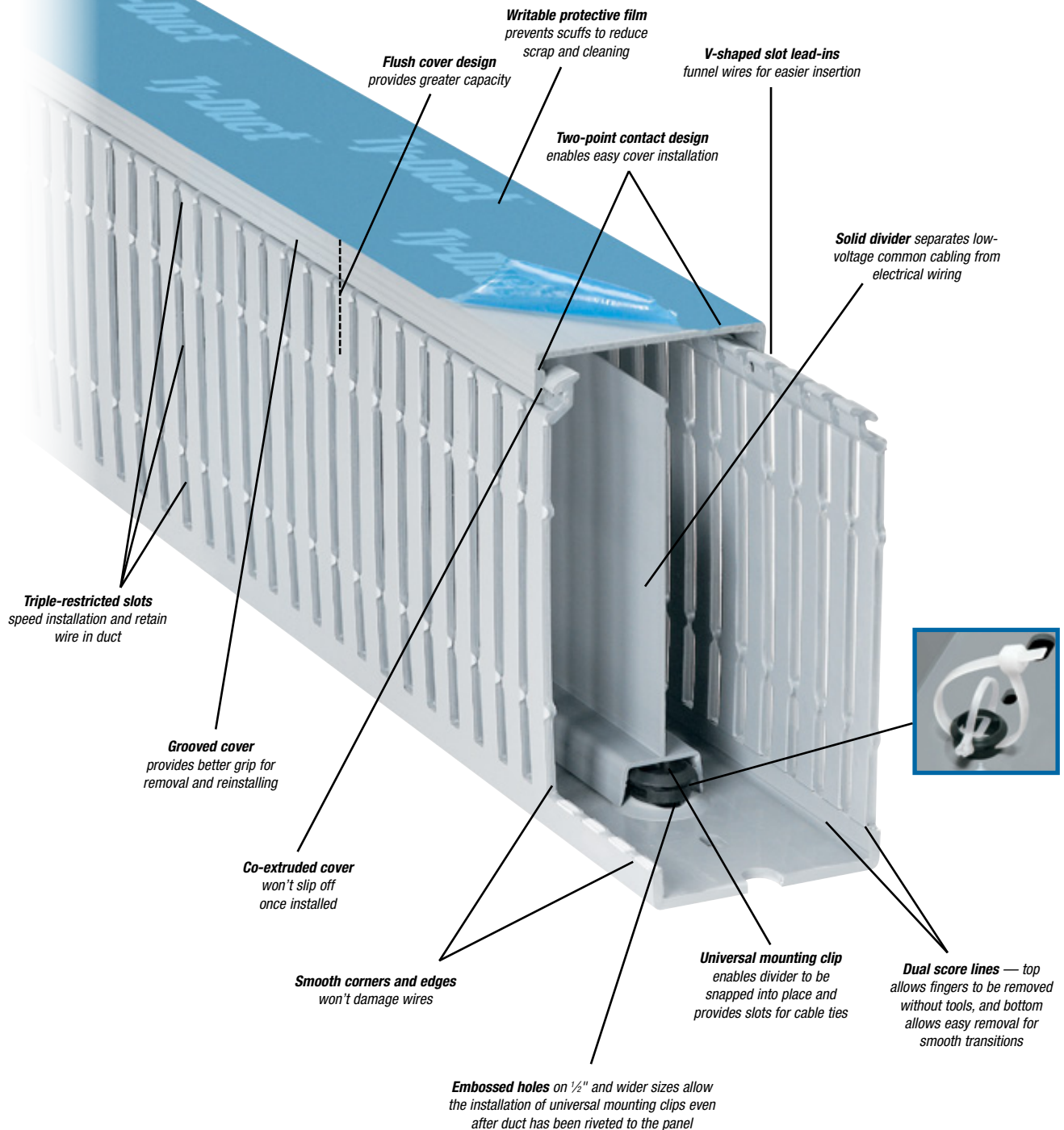

Ty-Duct® Wiring Duct

Ordering the Ty-Duct® products you need is easy!

Select the appropriate Ty-Duct® solutions for your application.

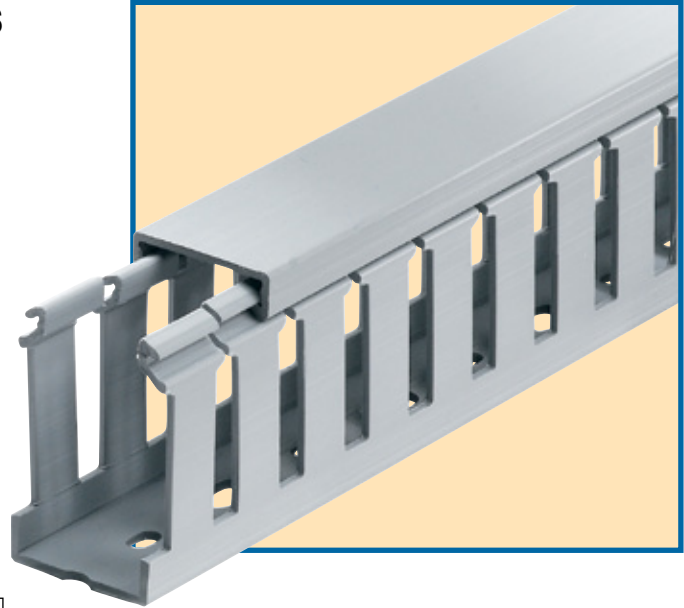

For Ty-Duct® Wiring Duct:

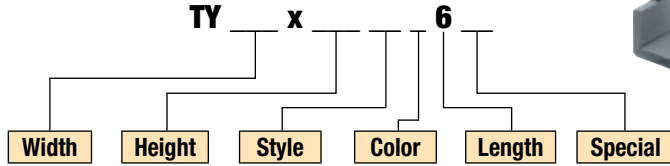

For Ty-Duct® Covers:

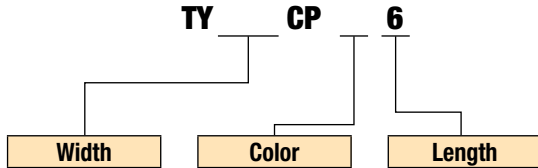

[_] = space for color identifier:

G = Gray

W = White

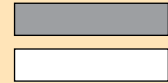

2 To order duct without mounting holes, add suffix NM to catalog number. **Example:** TY75X1WPG6NM is a .75" x 1" wide slot gray duct with no mounting holes.

CAT. NO.	DESCRIPTION	Nominal Width x Nominal Height		COVER CAT. NO.	Standard Carton Quantity		
		IN.	MM		DUCT CTN. QTY.	STD. COVER CTN. QTY.	LENGTH (FT.)
TY75X1WP[G]6NM	.75 x 1 Wide Slot Duct	.94	1.09	23.9 x 27.7	120		
TY75X15WP[W]6	.75 x 1.5 Wide Slot Duct	.94	1.56	23.9 x 39.6	120	120	6
TY75X2WP[W]6	.75 x 2 Wide Slot Duct	.94	2.07	23.9 x 52.6	120		

WP = Wide Slot
NP = Narrow Slot

1 Catalog Number must be completed by adding suffix **G** for Gray, **W** for White. **Example:** TY75x2WPW6 is a .75" x 2" wide slot white duct. Cover color must be specified also.

Standard lengths are 6 feet.

Note: See product expiration date on packages with adhesive. Periodically check product for adhesion and replace as needed. Product is for wire management only and is not intended for use as a primary support of wire, cable, etc.

Ty-Duct® Wiring Duct

Order Ty-Duct® Accessories

For Ty-Duct® Dividers:

Catalog Number must be completed by adding suffix SP for Solid or WP for Wide Slot.
Example: TY2DSPG6 is a 2" high solid wall gray divider.

CAT. NO.	DESCRIPTION	LENGTH (FT.)	STD. CTN. QTY
TY2D[SP][G]6	2" High Wall Divider	6	120

Catalog Number must be completed by adding suffix G for Gray, W for White.



Ty-Duct® Wiring Duct

Greater sidewall rigidity with increased versatility!

Wide Slot Wiring Duct — PVC

- Wide fingers and slots increase rigidity and enable insertion of bundles
- Non-slip cover does not slide easily and resists vibration
- Rounded edges keep hands and wires free of abrasion
- V-shaped slot lead-in enables easier and faster wire installation
- Dual score lines are designed to yield clean breakoffs at the base of the slot and the duct
- Restricted slot design makes sure that wires are held with or without the cover inserted
- Cover attaches flush with sidewall for finished look and increased wire capacity
- Versatile North American and DIN Standard mounting holes enables same duct for multiple applications

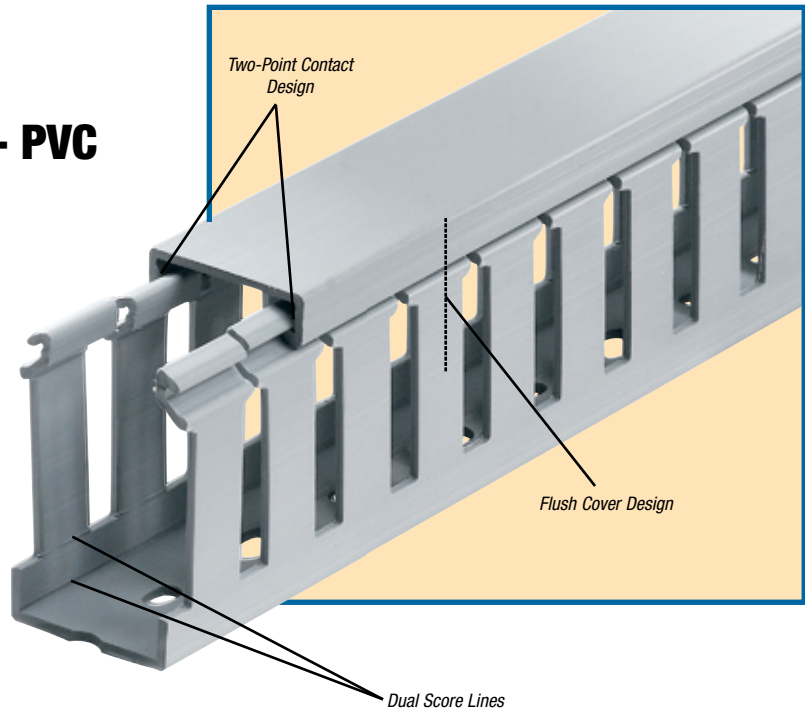

- Constructed of flame-retardant PVC
- Lead-free construction

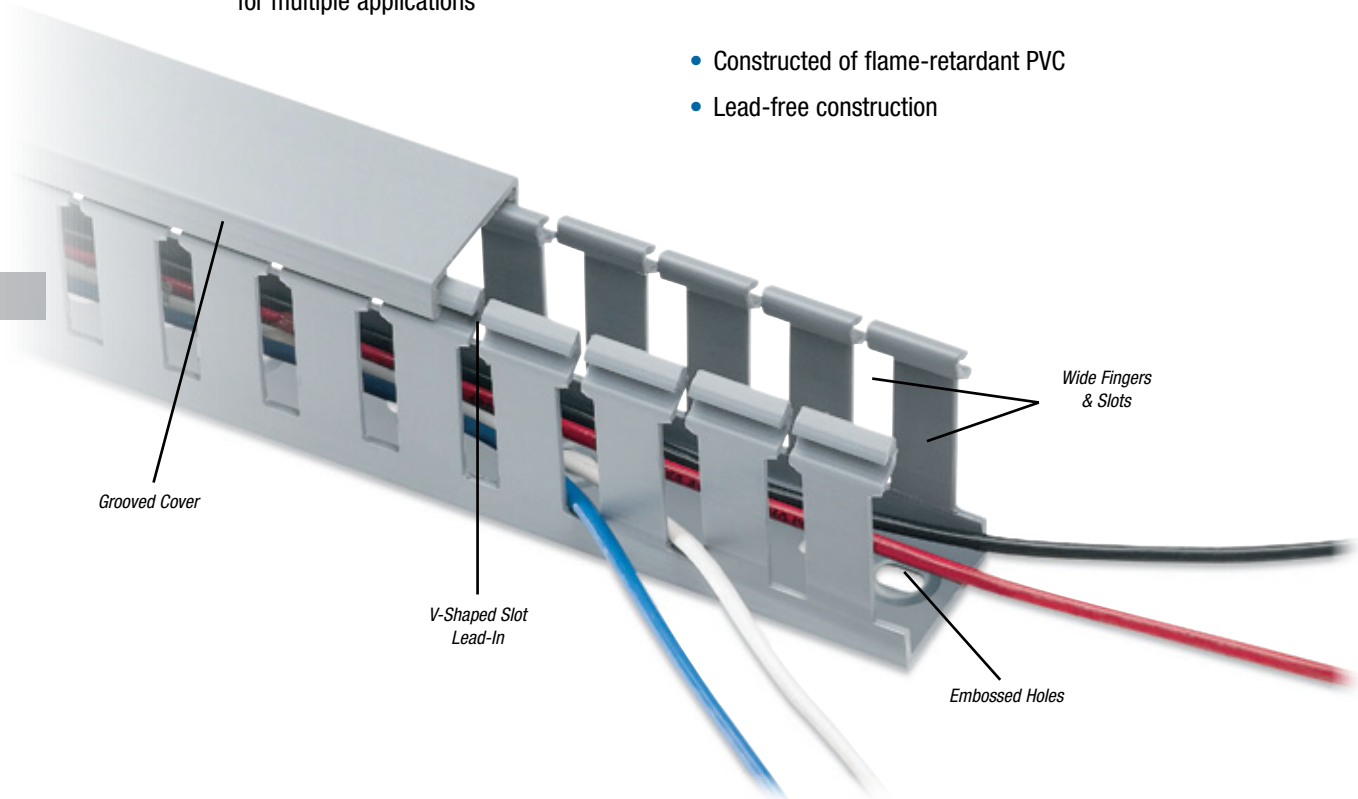

Ty-Duct® Wiring Duct

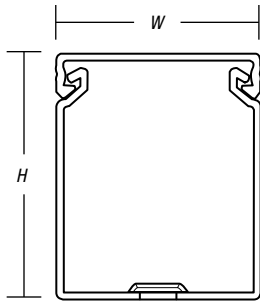

Front View with Cover

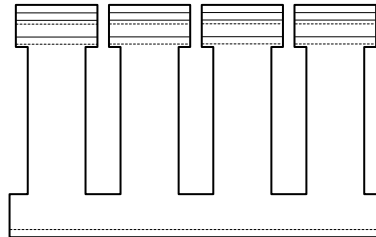

Side View without Cover

For a complete listing of Wide Slot mounting and dimensional details, see page C-84.



CAT. NO.*	DESCRIPTION	SIZE (W X H)		COVER CAT. NO.*	DUCT STD. CTN. QTY.	COVER STD. CTN. QTY.	LENGTH (FT.)
		IN.	MM				
TY75X15WP[_]6	.75" x 1.5"	.94 x 1.70	23.9 x 43.2	TY75CP[_]6	120	120	6
TY75X2WP[_]6	.75" x 2"	.94 x 2.19	23.9 x 55.6		120		
TY1X1WP[_]6	1" x 1"	1.25 x 1.24	31.8 x 31.5		120		
TY1X15WP[_]6	1" x 1.5"	1.25 x 1.70	31.8 x 43.2		120		
TY1X2WP[_]6	1" x 2"	1.25 x 2.19	31.8 x 55.6	TY1CP[_]6	120	120	6
TY1X3WP[_]6	1" x 3"	1.25 x 3.14	31.8 x 79.8		120		
TY1X4WP[_]6	1" x 4"	1.25 x 4.46	31.8 x 113.3		60		
TY15X15WP[_]6	1.5" x 1.5"	1.75 x 1.70	44.5 x 43.2		120		
TY15X2WP[_]6	1.5" x 2"	1.75 x 2.19	44.5 x 55.6	TY15CP[_]6	120	120	6
TY15X3WP[_]6	1.5" x 3"	1.75 x 3.14	44.5 x 79.8		120		
TY15X4WP[_]6	1.5" x 4"	1.75 x 4.46	44.5 x 113.3		60		
TY2X1WP[_]6	2" x 1"	2.25 x 1.24	57.2 x 31.5		120		
TY2X15WP[_]6	2" x 1.5"	2.25 x 1.70	57.2 x 43.2		120		
TY2X2WP[_]6	2" x 2"	2.25 x 2.19	57.2 x 55.6	TY2CP[_]6	120	120	6
TY2X3WP[_]6	2" x 3"	2.25 x 3.14	57.2 x 79.8		60		
TY2X4WP[_]6	2" x 4"	2.25 x 4.46	57.2 x 113.3		60		
TY2X5WP[_]6	2" x 5"	2.25 x 5.15	57.2 x 130.8		60		
TY25X2WP[_]6	2.5" x 2"	2.75 x 2.19	69.9 x 55.6		120		
TY25X3WP[_]6	2.5" x 3"	2.75 x 3.14	69.9 x 79.8	TY25CP[_]6	60	120	6
TY25X4WP[_]6	2.5" x 4"	2.75 x 4.46	69.9 x 113.3		60		
TY3X1WP[_]6	3" x 1"	3.25 x 1.24	82.6 x 31.5		120		
TY3X2WP[_]6	3" x 2"	3.25 x 2.19	82.6 x 55.6		60		
TY3X3WP[_]6	3" x 3"	3.25 x 3.14	82.6 x 79.8	TY3CP[_]6	60	120	6
TY3X4WP[_]6	3" x 4"	3.25 x 4.46	82.6 x 113.3		60		
TY3X5WP[_]6	3" x 5"	3.25 x 5.15	82.6 x 130.8		60		
TY4X3WP[_]6	4" x 3"	4.25 x 3.14	108.0 x 79.8	TY4CP[_]6	60	120	6
TY4X4WP[_]6	4" x 4"	4.25 x 4.46	108.0 x 113.3		30		
TY4X5WP[_]6	4" x 5"	4.25 x 5.15	108.0 x 130.8		30		
TY6X4WP[_]6	6" x 4"	6.25 x 4.46	158.8 x 113.3	TY6CP[_]6	30	60	6

[_] = space for color identifier:

G = Gray

W = White

* Catalog Number must be completed by adding suffix G for Gray, W for White.
Example: TY75X1WPG6 is a .75" x 1" wide slot gray duct.

To order duct without mounting holes, add suffix NM to catalog number.

Example: TY75X1WPG6NM is a .75" x 1" wide slot gray duct with no mounting holes.

PVC duct is UL® Recognized , CSA Certified and CE Compliant.

Ty-Duct® Wiring Duct

Designed to fit the spacing of high-density terminal blocks!

Narrow Slot Wiring Duct

- Smaller, higher number of fingers for more concise harnessing
- Non-slip cover does not slide easily and resists vibration
- Rounded edges keep hands and wires free of abrasion
- V-shaped slot lead-in enables easier and faster wire installation
- Restricted slot design makes sure that wires are held with or without the cover inserted
- Cover attaches flush with sidewall for finished look and increased wire capacity
- Versatile North American and DIN Standard mounting holes enable same duct for multiple applications
- Dual score lines are designed to yield clean breakoffs at the base of the slot and the duct

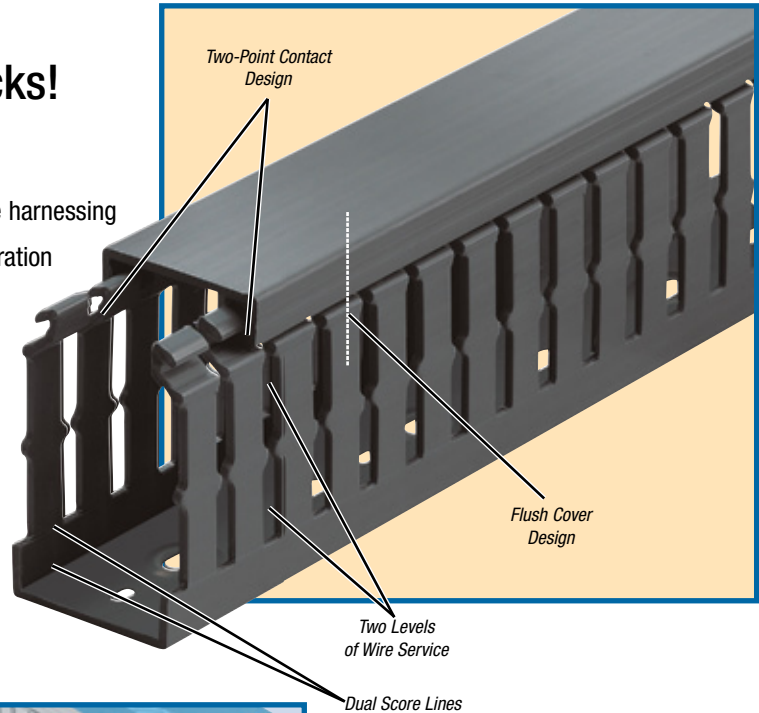

- Lead-free construction
- Constructed of flame-retardant PVC

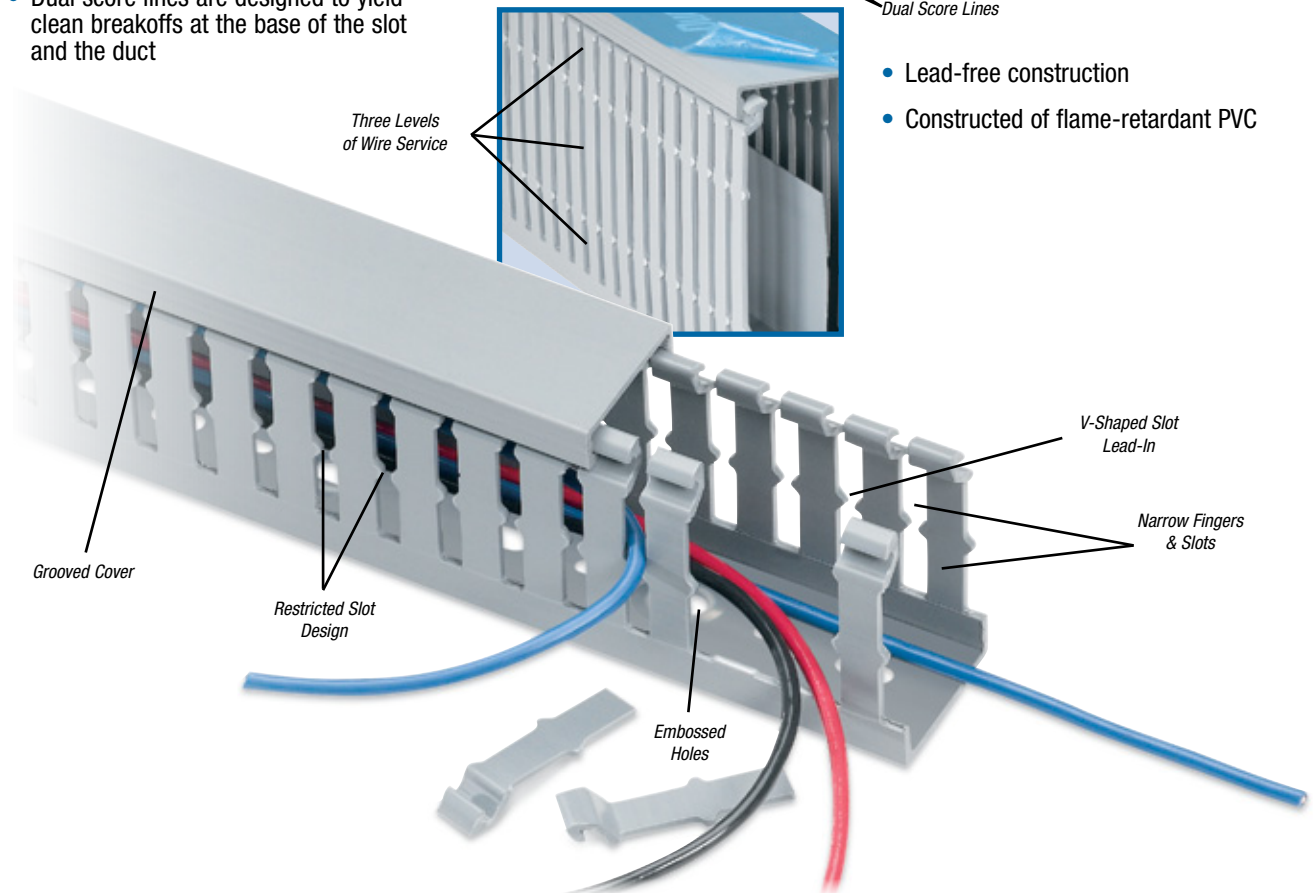

Ty-Duct® Wiring Duct

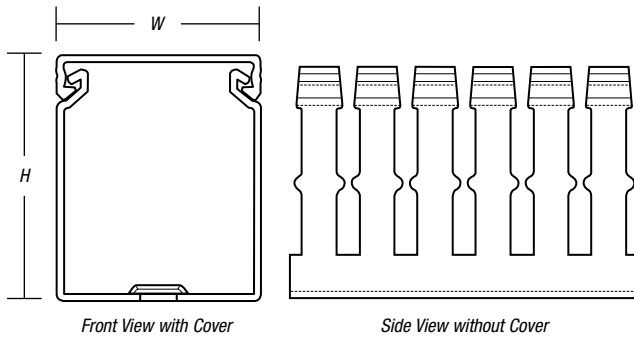

For a complete listing of Narrow Slot mounting and dimensional details, see page C-85.



CAT. NO.*	DESCRIPTION	SIZE (W X H)		COVER CAT. NO.*	DUCT STD. CTN. QTY.	COVER STD. CTN. QTY.	LENGTH (FT.)
		IN.	MM				
TY75X15NP[_]J6	.75" x 1.5"	.94 x 1.70	23.9 x 43.2	TY75CP[_]J6	120	120	6
TY1X1NP[_]J6	1" x 1"	1.25 x 1.24	31.8 x 31.5		120		
TY1X15NP[_]J6	1" x 1.5"	1.25 x 1.70	31.8 x 43.2		120		
TY1X2NP[_]J6	1" x 2"	1.25 x 2.19	31.8 x 55.6	TY1CP[_]J6	120	120	6
TY1X3NP[_]J6	1" x 3"	1.25 x 3.14	31.8 x 79.8		120		
TY1X4NP[_]J6	1" x 4"	1.25 x 4.46	31.8 x 113.3		60		
TY15X1NP[_]J6	1.5" x 1"	1.75 x 1.24	44.5 x 31.5		120		
TY15X15NP[_]J6	1.5" x 1.5"	1.75 x 1.70	44.5 x 43.2		120		
TY15X2NP[_]J6	1.5" x 2"	1.75 x 2.19	44.5 x 55.6	TY15CP[_]J6	120	120	6
TY15X3NP[_]J6	1.5" x 3"	1.75 x 3.14	44.5 x 79.8		120		
TY15X4NP[_]J6	1.5" x 4"	1.75 x 4.46	44.5 x 113.3		60		
TY2X1NP[_]J6	2" x 1"	2.25 x 1.24	57.2 x 31.5		120		
TY2X15NP[_]J6	2" x 1.5"	2.25 x 1.70	57.2 x 43.2		120		
TY2X2NP[_]J6	2" x 2"	2.25 x 2.19	57.2 x 55.6	TY2CP[_]J6	120	120	6
TY2X3NP[_]J6	2" x 3"	2.25 x 3.14	57.2 x 79.8		60		
TY2X4NP[_]J6	2" x 4"	2.25 x 4.46	57.2 x 113.3		60		
TY2X5NP[_]J6	2" x 5"	2.25 x 5.15	57.2 x 130.8		60		
TY25X2NP[_]J6	2.5" x 2"	2.75 x 2.19	69.9 x 55.6		120		
TY25X3NP[_]J6	2.5" x 3"	2.75 x 3.14	69.9 x 79.8	TY25CP[_]J6	60	120	6
TY25X4NP[_]J6	2.5" x 4"	2.75 x 4.46	69.9 x 113.3		60		
TY3X1NP[_]J6	3" x 1"	3.25 x 1.24	82.6 x 31.5		120		
TY3X2NP[_]J6	3" x 2"	3.25 x 2.19	82.6 x 55.6		60		
TY3X3NP[_]J6	3" x 3"	3.25 x 3.14	82.6 x 79.8	TY3CP[_]J6	60	120	6
TY3X4NP[_]J6	3" x 4"	3.25 x 4.46	82.6 x 113.3		60		
TY3X5NP[_]J6	3" x 5"	3.25 x 5.15	82.6 x 130.8		60		
TY4X2NP[_]J6	4" x 2"	4.25 x 2.19	108.0 x 55.6		60		
TY4X3NP[_]J6	4" x 3"	4.25 x 3.14	108.0 x 79.8	TY4CP[_]J6	60	120	6
TY4X4NP[_]J6	4" x 4"	4.25 x 4.46	108.0 x 113.3		30		
TY4X5NP[_]J6	4" x 5"	4.25 x 5.15	108.0 x 130.8		30		

[] = space for color identifier:

G = Gray

W = White

* Catalog Number must be completed by adding suffix G for Gray, W for White.
Example: TY75X15NPB6 is a .75" x 1.5" narrow slot black duct.
 To order duct without mounting holes, add suffix NM to catalog number.
Example: TY75X15NPB6NM is a .75" x 1.5" narrow slot black duct with no mounting holes.
 PVC duct is UL Recognized , CSA Certified and CE Compliant.

Ty-Duct® Wiring Duct

Perfect for passenger or crew areas where smoke toxicity is a concern!

Halogen-Free Wide Slot Wiring Duct

- Halogen-free construction — RoHS Compliant
- Higher temperature rating than standard PVC material (203° F/95° C)
- UL94V-1 flammability rating
- Wide fingers and slots increase rigidity and enable for insertion of bundles
- Non-slip cover does not slide easily and resists vibration
- Dual score lines are designed to yield clean breakoffs at the base of the slot and the duct
- V-shaped slot lead-in enables easier and faster wire installation

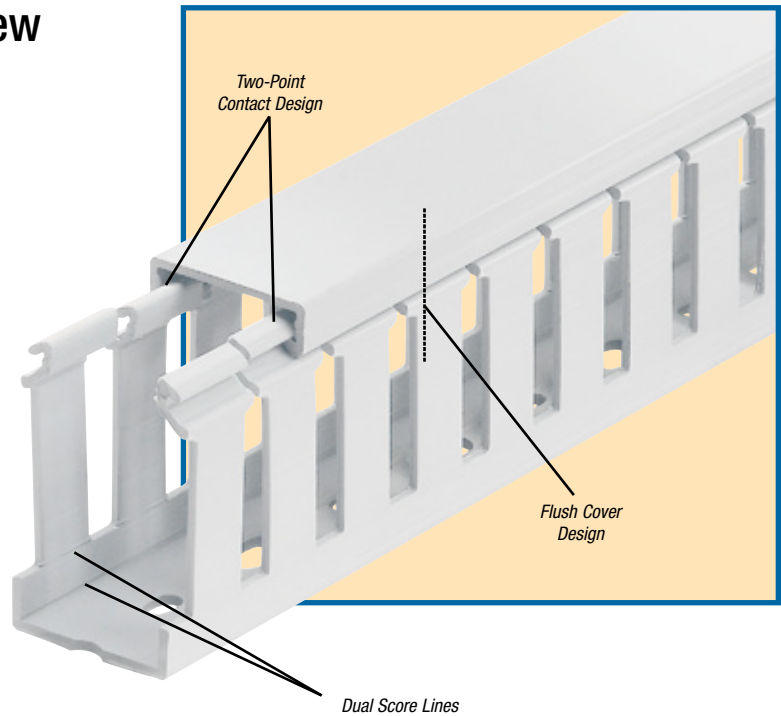

- Light weight
- Typical applications include rail/mass transit/subway cars, shops and offshore oil and gas platforms

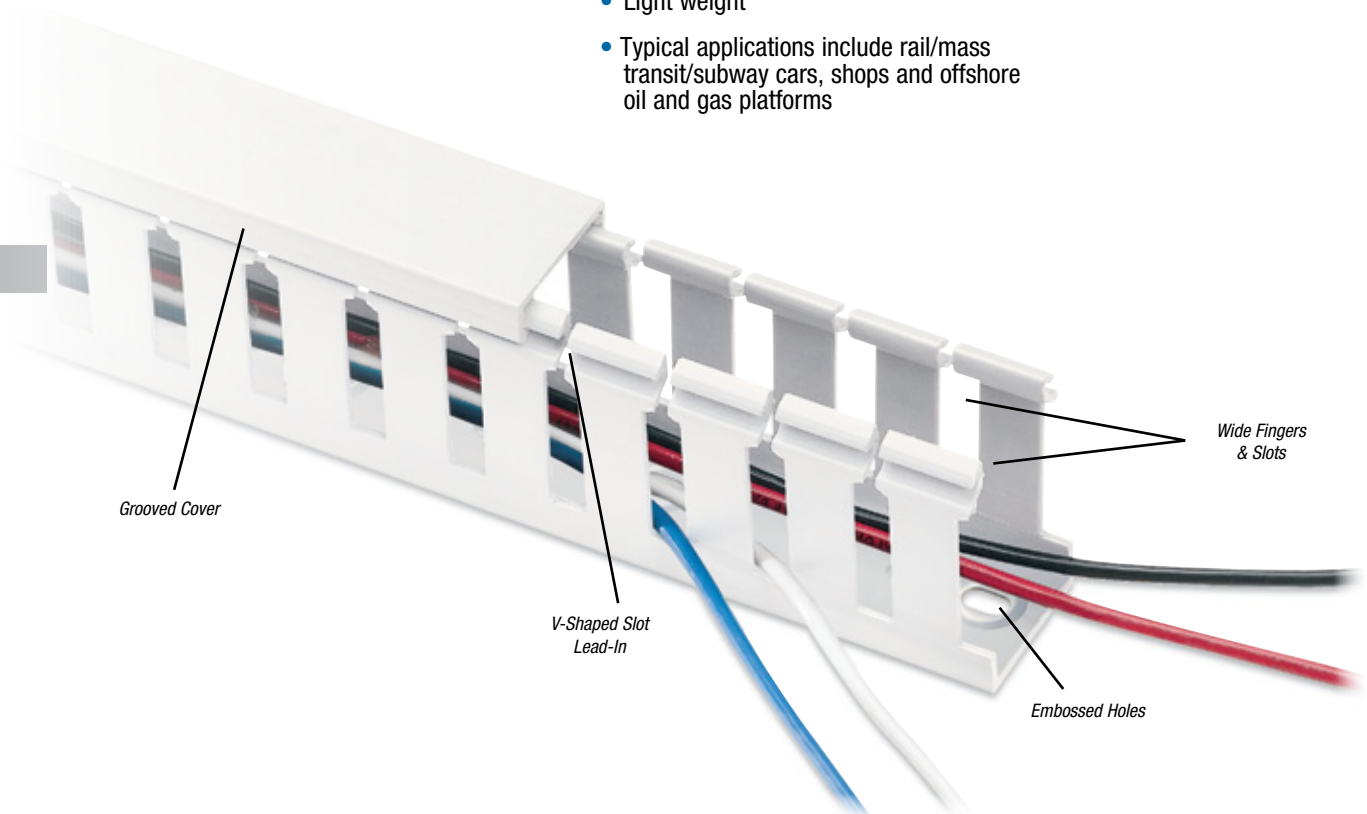

Ty-Duct® Wiring Duct

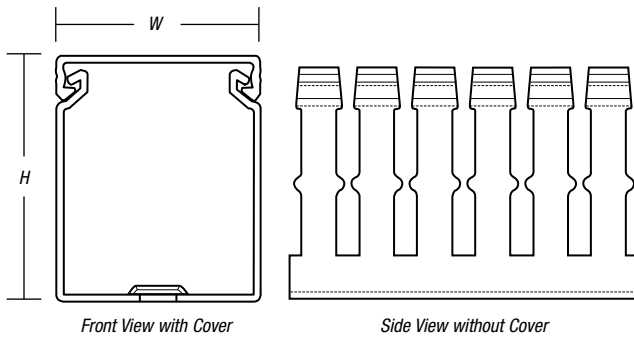

For a complete listing of Solid Wall mounting and dimensional details, see page C-84.



CAT. NO.	DESCRIPTION	SIZE (W X H)		COVER CAT. NO.	DUCT STD. CTN. QTY.	COVER STD. CTN. QTY.	LENGTH (FT.)
		IN.	MM				
TY1X1WHW6	1" x 1"	1.25 x 1.24	31.8 x 31.5		120		
TY1X15WHW6	1" x 1.5"	1.25 x 1.70	31.8 x 43.2		120		
TY1X2WHW6	1" x 2"	1.25 x 2.19	31.8 x 55.6	TY1CHW6	120	120	6
TY1X3WHW6	1" x 3"	1.25 x 3.14	31.8 x 79.8		120		
TY1X4WHW6	1" x 4"	1.25 x 4.46	31.8 x 113.3		60		
TY15X15WHW6	1.5" x 1.5"	1.75 x 1.70	44.5 x 43.2		120		
TY15X2WHW6	1.5" x 2"	1.75 x 2.19	44.5 x 55.6	TY15CHW6	120	120	6
TY15X3WHW6	1.5" x 3"	1.75 x 3.14	44.5 x 79.8		120		
TY15X4WHW6	1.5" x 4"	1.75 x 4.46	44.5 x 113.3		60		
TY2X1WHW6	2" x 1"	2.25 x 1.24	57.2 x 31.5		120		
TY2X2WHW6	2" x 2"	2.25 x 2.19	57.2 x 55.6	TY2CHW6	120	120	6
TY2X3WHW6	2" x 3"	2.25 x 3.14	57.2 x 79.8		60		
TY2X4WHW6	2" x 4"	2.25 x 4.46	57.2 x 113.3		60		
TY3X1WHW6	3" x 1"	3.25 x 1.24	82.6 x 31.5		120		
TY3X2WHW6	3" x 2"	3.25 x 2.19	82.6 x 55.6		60		
TY3X3WHW6	3" x 3"	3.25 x 3.14	82.6 x 79.8	TY3CHW6	60	120	6
TY3X4WHW6	3" x 4"	3.25 x 4.46	82.6 x 113.3		60		
TY3X5WHW6	3" x 5"	3.25 x 5.15	82.6 x 130.8		60		
TY4X2WHW6	4" x 2"	4.25 x 2.19	108.0 x 55.6		60		
TY4X3WHW6	4" x 3"	4.25 x 3.14	108.0 x 79.8	TY4CHW6	60	120	6
TY4X4WHW6	4" x 4"	4.25 x 4.46	108.0 x 113.3		30		
TY4X5WHW6	4" x 5"	4.25 x 5.15	108.0 x 130.8		30		

Halogen-Free Wiring Duct Solid Divider Wall



CAT. NO.	FITS DUCT TRADE SIZE	STD. CTN. QTY.	LENGTH (FT.)
TY1DSHW6	1" H	120	6
TY1.5DSHW6	1½" H	120	6
TY2DSHW6	2" H	120	6
TY3DSHW6	3" H	1120	6
TY4DSHW6	4" H	120	6
TY5DSHW6	5" H	120	6

W = White

To order duct without mounting holes, add suffix NM to catalog number.
Example: TY1XWHW6NM is a 1" x 1" wide slot halogen-free white duct with no mounting holes.
 Halogen-free (modified PPE) duct is UL® Recognized CSA Certified and meets the JIC requirements.

Fastening Systems — Wiring Duct & Wiring Trough

Wiring Duct Tools and Accessories

Create multiple channels inside wiring ducts!

Divider Wall

- Separates high and low voltage to reduce shortages and interference
- Mount inside any Ty-Duct® PVC wiring duct using Universal Mounting Clips
- Solid and Wide Slotted style



CAT. NO.	DESCRIPTION	LENGTH (FT.)	STD. CTN. QTY.
TY1D[_]P[_]6	1" High Wall Divider	6	120
TY1.5D[_]P[_]6	1.5" High Wall Divider	6	120
TY2D[_]P[_]6	2" High Wall Divider	6	120
TY3D[_]P[_]6	3" High Wall Divider	6	120
TY4D[_]P[_]6	4" High Wall Divider	6	120
TY5D[_]P[_]6	5" High Wall Divider	6	120

+Catalog number must be completed first by adding S for Solid divider or W for Wide Finger Slotted divider and then by adding G for Gray, W for White.

Examples: TY2DSPG6 is a 2" high solid wall gray divider.
TY2DWPG6 is a 2" high slotted gray divider.

One size fits all!

Universal Mounting Clips

- Added before or after the duct is in place, without additional hardware
- Twists into place — holds securely
- Installs easily using a screwdriver
- Accommodates up to 40 lb. cable ties
- Black polycarbonate
- For ½" and wider wiring duct sizes



CAT. NO.	DESCRIPTION	QTY.
UMC	Universal Fastener Mount	100 pk

Wiring Duct Tools and Accessories

Ideal for high-temperature environments!

Mounting Clips

- Speeds duct mounting
- Enables duct removal
- Provides a stand-off between panel and duct to prevent direct heat transfer — ideal for high-temperature environments

NEW!

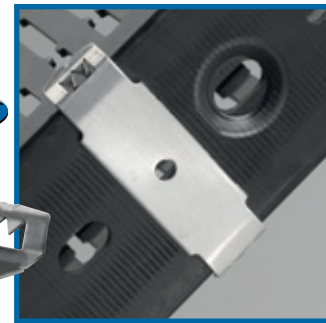

CAT. NO.	WIDTH (IN.)	STD. CTN. QTY.
TY1MC	1	100
TY15MC	1.5	100
TY2MC	2	100
TY3MC	3	100

All are .75"D x .35"H and made of Type 316 stainless steel.

Plastic rivets make mounting ducts easy!

Plastic Rivets



- Fast installation
- Durable and economical
- Used with panel thickness from .030"–.125" thick
- Recommended Panel Hole size: .196" ± .02

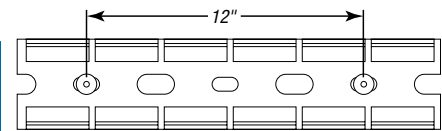

Minimum mounting rivet distance for ducts less than 1/2" wide.

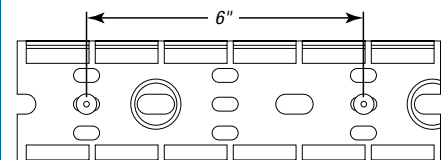

Minimum mounting rivet distance for ducts 1/2" to 2/2" wide.

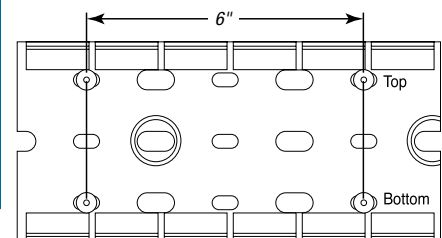

Minimum mounting rivet distance for ducts greater than 2/2" wide. Installed top and bottom.

STD. CAT. NO.	DESCRIPTION	QTY.
08200C	3/16" Plastic Rivet	100 pk
08200M	3/8" Plastic Rivet	1,000 pk

Wiring Duct Tools and Accessories

The wiring duct tools you need for every application!

Features include:

- Duct Cutting Tools for a clean professional finish
- Finger Cutting Tools that make modifications simple
- Notching Tools for duct sidewalls to facilitate tee and corner junctions
- Benchmark Cutting Tools for fast, high volume duct cutting
- Rivet Installation Tools for quick duct mounting

Lightweight and durable!

Duct/ Cover Cutting Tool



**Improved
Performance!**

- All-steel construction
- Sharp cutting surface
- Replaceable blades available

CAT. NO.	DESCRIPTION
CC125	Handheld Duct Cutter
SX-25TB	Handheld Duct Cutter — Long

Cut duct fingers easily!

Finger Cutting Tool



- Rugged die-cast construction with insulated handles for a comfortable, non-slip grip
- Removes duct fingers in tight places
- Works with all slotted wiring duct
- Also cuts round and solid wall duct
- Spring loaded

CAT. NO.	DESCRIPTION
DK-65TB	Duct Finger Cutter

Wiring Duct Tools and Accessories

For fast, high-volume duct cutting!

Benchmount Cutting Tool

- Engineered for use with Ty-Duct® plastic wiring ducts and covers
- All-steel construction lasts for years
- Adjustable gauge sets the desired length of duct
- Easy-to-read measuring indicator
- Adjustable stop for easy repeated cutting
- Sharp, easy-to-replace blades

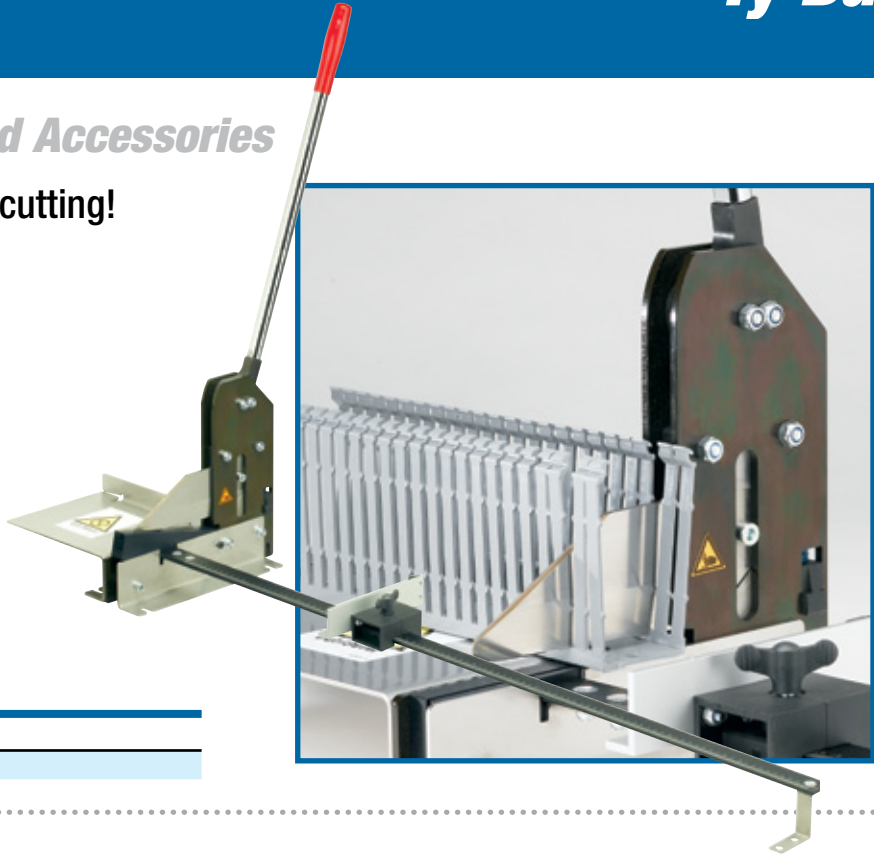

CAT. NO.	DESCRIPTION
DC-125TB	Benchmount Duct Cutter

Notch duct sidewalls fast!

Notching Tool



- Notches sidewalls to bottom scoreline
- Facilitates tee and corner junctions
- Rugged design
- Easy to use
- Spring loaded

CAT. NO.	DESCRIPTION
DNT-100TB	Duct Notching Tool

Mount ducts quickly!

Rivet Installation Tool

- Use for setting duct rivets
- Pressure on the tool head secures the rivet in place



You may also need...



Plastic Rivets
(see page C-79)

CAT. NO.	DESCRIPTION
08205	08200 Series Rivet Installation Tool

Wiring Duct Technical Information

Wiring Duct — Wire Fill Capacity

Note: Wire fill is based on 50% fill of duct area.

NORMAL DUCT SIZE (IN.)			ELECTRICAL											DATA CABLE						
			8 AWG		10 AWG		12 AWG		14 AWG			16 AWG		18 AWG		22 AWG		24 AWG		
			0.216	0.153	0.122	0.158	0.105	0.139	0.165	0.096	0.125	0.084	0.113	0.065	0.217	0.250	0.422			
W	H	AREA (INCHES ²)	THHN	THHN	THHN	MTW	THHN	MTW	MTW	THHN	MTW	THHN	MTW	MTW	UTP/CM CAT5E	UTP/CM CAT6	UTP/CM			
.75	X	1.00	.750	5	9	14	9	19	11	8	23	14	30	17	51	5	3	1		
.75	X	1.50	1.125	7	14	22	13	29	17	12	35	21	46	25	76	7	5	2		
.75	X	2.00	1.500	9	18	29	17	39	22	16	47	27	61	34	101	9	7	2		
1.00	X	1.00	1.000	6	12	19	11	26	15	10	31	18	40	22	68	6	5	2		
1.00	X	1.50	1.500	9	18	29	17	39	22	16	47	27	61	34	101	9	7	2		
1.00	X	2.00	2.000	12	24	38	23	52	30	21	62	37	81	45	135	12	9	3		
1.00	X	3.00	3.000	18	37	58	34	78	44	31	93	55	121	67	203	18	14	5		
1.00	X	4.00	4.000	24	49	77	46	104	59	42	124	73	162	90	270	24	18	6		
1.50	X	1.00	1.500	9	18	29	17	39	22	16	47	27	61	34	101	9	7	2		
1.50	X	1.50	2.250	14	27	43	26	58	33	24	70	41	91	50	152	14	10	4		
1.50	X	2.00	3.000	18	37	58	34	78	44	31	93	55	121	67	203	18	14	5		
1.50	X	3.00	4.500	27	55	86	52	117	67	47	140	82	182	101	304	27	21	7		
1.50	X	4.00	6.000	36	73	115	69	155	89	63	186	110	243	134	406	36	27	10		
2.00	X	1.00	2.000	12	24	38	23	52	30	21	62	37	81	45	135	12	9	3		
2.00	X	1.50	3.000	18	37	58	34	78	44	31	93	55	121	67	203	18	14	5		
2.00	X	2.00	4.000	24	49	77	46	104	59	42	124	73	162	90	270	24	18	6		
2.00	X	3.00	6.000	36	73	115	69	155	89	63	186	110	243	134	406	36	27	10		
2.00	X	4.00	8.000	48	98	154	92	207	118	84	248	146	324	179	541	49	37	13		
2.00	X	5.00	10.000	60	122	192	114	259	148	105	310	183	405	224	676	61	46	16		
2.50	X	2.00	5.000	30	61	96	57	130	74	52	155	91	202	112	338	30	23	8		
2.50	X	3.00	7.500	45	92	144	86	194	111	79	233	137	304	168	507	46	34	12		
2.50	X	4.00	10.000	60	122	192	114	259	148	105	310	183	405	224	676	61	46	16		
3.00	X	1.00	3.000	18	37	58	34	78	44	31	93	55	121	67	203	18	14	5		
3.00	X	2.00	6.000	36	73	115	69	155	89	63	186	110	243	134	406	36	27	10		
3.00	X	3.00	9.000	54	110	173	103	233	133	94	279	165	364	201	609	55	41	14		
3.00	X	4.00	12.000	72	146	230	137	311	177	126	372	219	486	269	811	73	55	19		
3.00	X	5.00	15.000	90	183	288	172	389	222	157	465	274	607	336	1014	91	69	24		
4.00	X	1.50	6.000	36	73	115	69	155	89	63	186	110	243	134	406	36	27	10		
4.00	X	2.00	8.000	48	98	154	92	207	118	84	248	146	324	179	541	49	37	13		
4.00	X	3.00	12.000	72	146	230	137	311	177	126	372	219	486	269	811	73	55	19		
4.00	X	4.00	16.000	96	195	307	183	415	237	168	496	293	648	358	1082	97	73	26		
4.00	X	5.00	20.000	120	244	384	229	518	296	210	620	366	810	448	1352	121	91	32		
6.00	X	4.00	24.000	144	293	461	275	622	355	252	744	439	972	537	1623	146	110	39		

Formula for Calculating Fill Capacity

$$\text{Number of wires} = \frac{\text{Duct } W \times H}{1.75 \times (\text{Wire O.D.})^2} \div 2$$

Wiring Duct Technical Information

Properties of Materials Used in Wiring Duct

PROPERTY	UNITS	ASTM TEST	PVC	HALOGEN FREE
Specific Gravity		D792	1.43	1.10
IZOD	ft.-lb./in.	D256	2	5.0
Flexural Strength	psi	D790	10,900	12,800
Flexural Modulus	psi	D790	382,000	360,000
Tensile Strength	psi	D638	5,500	7,800
Compressive Strength	psi	D695	8,600	16,000
Water Absorption	24 hrs.—%	D570	.10	.07
Hardness	Rockwell	D785	R-111	R-115
	Duro D	D676	78	
Dielectric Strength		D149		
60Hz, 25° C, s/t	vpm			400
Dielectric Constant		D150		
	60Hz, Dry		1.9	2.65
	1MHz, Dry			2.64
Volume Resistivity	ohm-cm	D257		1017
Heat Deflecting (° F@ 264 psi)	° F	D648	158	212
Flammability			94 V-0	94 V-1

The above information is believed reliable. The user should, however, check the applicable specifications to verify values.

Rigid Polyvinyl Chloride (PVC)

- General-purpose material for indoor applications
- UL94 flammability rating of V-0
- UL® Recognized for use in temperatures up to 50° C (122° F)
- Economical wiring duct material

Halogen Free

- For use in halogen-free or high-temperature applications
- UL94 flammability rating of V-1
- UL® Recognized for use in higher temperatures up to 95° C (203° F)
- 20% lighter than PVC

Wiring Duct Technical Information

Ty-Duct® Wide Slot Wiring Duct Dimensions

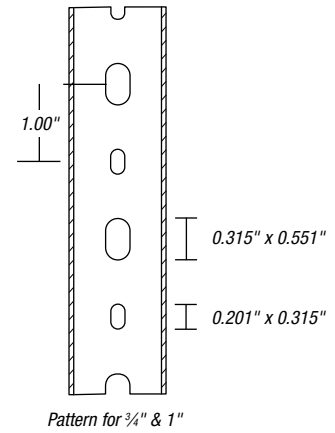
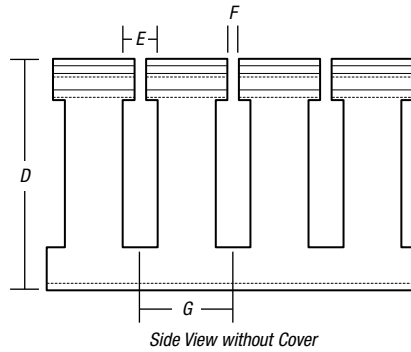
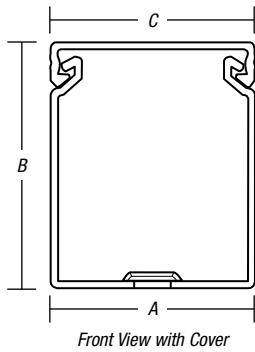

TRADE SIZE		DIMENSIONS (INCHES)						
W	H	A	B	C	D	E	F	G
.75	X 1.00	.94	1.24	.94	1.03	.30	.10	.80
.75	X 1.50	.94	1.70	.94	1.50	.30	.10	.80
.75	X 2.00	.94	2.19	.94	2.01	.30	.10	.80
1.00	X 1.00	1.25	1.24	1.25	1.03	.30	.10	.80
1.00	X 1.50	1.25	1.70	1.25	1.50	.30	.10	.80
1.00	X 2.00	1.25	2.19	1.25	2.01	.30	.10	.80
1.00	X 3.00	1.25	3.14	1.25	2.99	.30	.10	1.00
1.00	X 4.00	1.25	4.46	1.25	4.32	.30	.10	1.00
1.50	X 1.00	1.75	1.24	1.75	1.03	.30	.10	.80
1.50	X 1.50	1.75	1.70	1.75	1.50	.30	.10	.80
1.50	X 2.00	1.75	2.19	1.75	2.01	.30	.10	.80
1.50	X 3.00	1.75	3.14	1.75	2.99	.30	.10	1.00
1.50	X 4.00	1.75	4.46	1.75	4.32	.30	.10	1.00
2.00	X 1.00	2.25	1.24	2.25	1.05	.30	.10	.80
2.00	X 1.50	2.25	1.70	2.25	1.52	.30	.10	.80
2.00	X 2.00	2.25	2.19	2.25	2.03	.30	.10	.80
2.00	X 3.00	2.25	3.14	2.25	3.00	.30	.10	1.00
2.00	X 4.00	2.25	4.46	2.25	4.33	.30	.10	1.00
2.00	X 5.00	2.25	5.15	2.25	5.02	.38	.10	1.33
2.50	X 2.00	2.75	2.19	2.75	2.03	.30	.10	.80
2.50	X 3.00	2.75	3.14	2.75	3.00	.30	.10	1.00
2.50	X 4.00	2.75	4.46	2.75	4.33	.30	.10	1.00
3.00	X 1.00	3.25	1.24	3.25	1.06	.30	.10	.80
3.00	X 2.00	3.25	2.19	3.25	2.08	.30	.10	.80
3.00	X 3.00	3.25	3.14	3.25	3.06	.30	.10	1.00
3.00	X 4.00	3.25	4.46	3.25	4.39	.30	.10	1.00
3.00	X 5.00	3.25	5.15	3.25	5.06	.38	.10	1.33
4.00	X 1.50	4.25	1.70	4.25	1.58	.30	.10	.80
4.00	X 2.00	4.25	2.19	4.25	2.08	.30	.10	.80
4.00	X 3.00	4.25	3.14	4.25	3.06	.30	.10	1.00
4.00	X 4.00	4.25	4.46	4.25	4.39	.30	.10	1.00
4.00	X 5.00	4.25	5.15	4.25	5.06	.38	.10	1.33
6.00	X 4.00	6.25	4.46	6.25	4.39	.30	.10	1.00

Dimensions shown are for reference only. Contact T&B for specific dimensional needs.

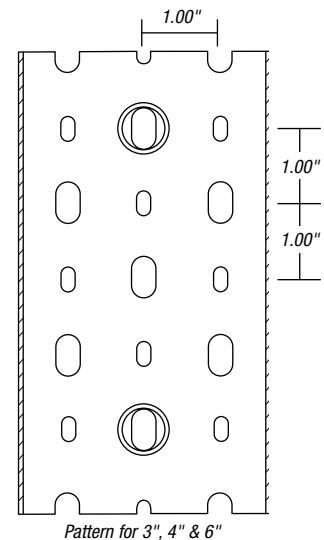
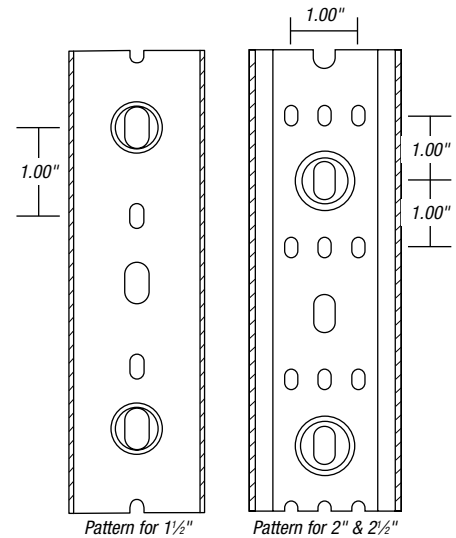

Wiring Duct Technical Information

Ty-Duct® Narrow Slot Wiring Duct Dimensions

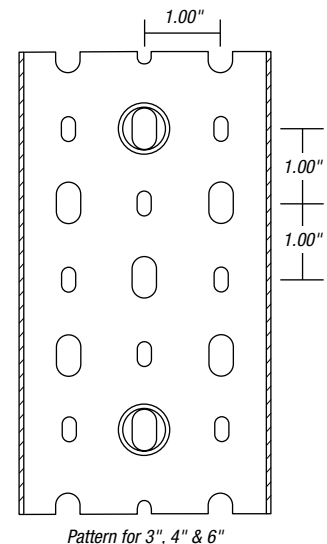
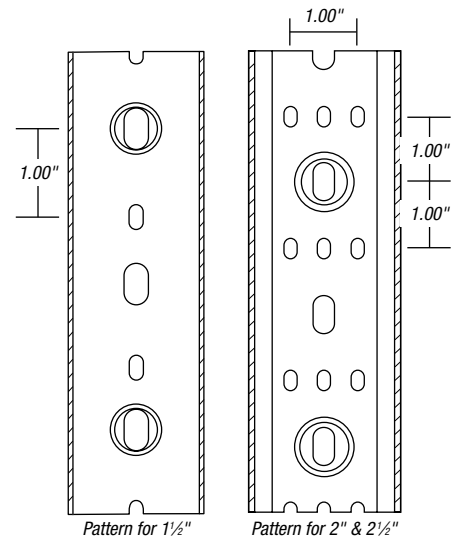
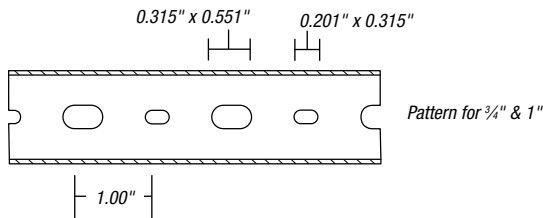
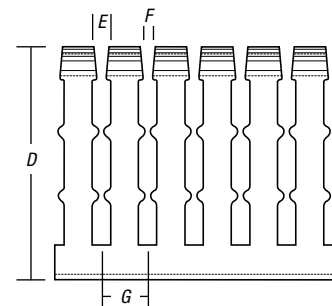
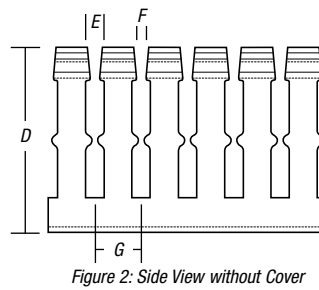
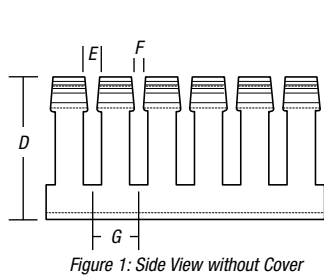
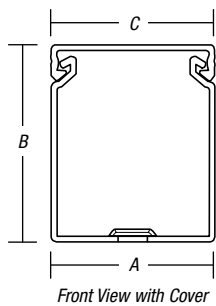

TRADE SIZE		FIG.	DIMENSIONS (INCHES)						
W	H		A	B	C	D	E	F	G
.75	X 1.50	1	.94	1.70	.94	1.70	.195	.10	.50
1.00	X 1.00	1	1.25	1.24	1.25	1.24	.195	.10	.50
1.00	X 1.50	1	1.25	1.70	1.25	1.70	.195	.10	.50
1.00	X 2.00	2	1.25	2.19	1.25	2.19	.195	.10	.50
1.00	X 3.00	3	1.25	3.14	1.25	3.14	.195	.10	.50
1.00	X 4.00	3	1.25	4.46	1.25	4.46	.195	.10	.50
1.50	X 1.00	1	1.75	1.24	1.75	1.24	.195	.10	.50
1.50	X 1.50	1	1.75	1.70	1.75	1.70	.195	.10	.50
1.50	X 2.00	2	1.75	2.19	1.75	2.19	.195	.10	.50
1.50	X 3.00	3	1.75	3.14	1.75	3.14	.195	.10	.50
1.50	X 4.00	3	1.75	4.46	1.75	4.46	.195	.10	.50
2.00	X 1.00	1	2.25	1.24	2.25	1.05	.195	.10	.50
2.00	X 1.50	1	2.25	1.70	2.25	1.52	.195	.10	.50
2.00	X 2.00	2	2.25	2.19	2.25	2.03	.195	.10	.50
2.00	X 3.00	3	2.25	3.14	2.25	3.00	.195	.10	.50
2.00	X 4.00	3	2.25	4.46	2.25	4.33	.195	.10	.50
2.00	X 5.00	3	2.25	5.15	2.25	5.02	.195	.10	.50
2.50	X 2.00	2	2.75	2.19	2.75	2.03	.195	.10	.50
2.50	X 3.00	3	2.75	3.14	2.75	3.00	.195	.10	.50
2.50	X 4.00	3	2.75	4.46	2.75	4.33	.195	.10	.50
3.00	X 1.00	1	3.25	1.24	3.25	1.06	.195	.10	.50
3.00	X 2.00	2	3.25	2.19	3.25	2.08	.195	.10	.50
3.00	X 3.00	3	3.25	3.14	3.25	3.06	.195	.10	.50
3.00	X 4.00	3	3.25	4.46	3.25	4.39	.195	.10	.50
3.00	X 5.00	3	3.25	5.15	3.25	5.06	.195	.10	.50
4.00	X 2.00	2	4.25	2.19	4.25	2.08	.195	.10	.50
4.00	X 3.00	3	4.25	3.14	4.25	3.06	.195	.10	.50
4.00	X 4.00	3	4.25	4.46	4.25	4.39	.195	.10	.50
4.00	X 5.00	3	4.25	5.15	4.25	5.06	.195	.10	.50

Dimensions shown are for reference only. Contact T&B for specific dimensional needs.

Wiring Duct Technical Information

Ty-Duct® Wiring Duct meets all of the prominent agency approvals and standards.

Agency Approvals

Thomas & Betts Ty-Duct® wiring duct is UL® recognized for all requirements set forth in UL standard 1565 "Positioning Device."



Ty-Duct® wiring duct meets all applicable requirements of the Canadian Standard Association as described in CSA C22.2 No. 18.5.



All Ty-Duct® wiring duct components comply with the European Directives for CE (Conformite Europeen) Marking.



All materials used in the making of the Ty-Duct® wiring duct comply with the European Directives 2002/95/EC (RoHS), 2002/96/EC (WEEE), and 2003/11/EC.

Standards

NFPA-79-2011

Thomas & Betts Ty-Duct® wiring duct is compliant with the National Fire Protection Agency NFPA-79-2011. All materials used in the manufacturing of the Ty-Duct® components are selected from flame-retardant material and comply with IEC 60332-1. The testing is required in order to comply with NFPA-79-2011, Section 13.3.1.

UL 508/UL 508A

As required in UL508/UL508A a factory-installed conductor shall be separated from a conductor used in a different circuit when the conductors are not insulated for the maximum voltage of either circuit. The Ty-Duct® wiring duct with a divider wall creates the required separation to meet this requirement.

DIN 43 659

This European standard specifies dimensions for slotted trunkings installed in electrical switchgear assemblies. The standard defines the following dimensions:

- The mounting hole pattern
- The mounting hole slot dimensions
- The mounting hole pitch and location
- The minimum overall product length

Carlon® Wiring Trough and Accessories

No wires to pull, no hard-to-work-with metal components.

Carlon® Wire Safe® Wireway and Wiring Trough

Carlon® leads the way with the world's broadest line of non-metallic wiring management products designed for easier installation, greater performance and lower installed cost. That includes our Carlon® Wire Safe® wireway, wiring trough and fittings. It's the perfect solution for containing electrical, electronic and communication wire and cable. That's because it's easy to install, provides durable protection and eliminates the need to pull conductors, too. Just compare it point for point against the competition and you'll see why it's the best alternative for you.



Easy to Cut and Assemble.

Wireway and trough can be cut easily and cleanly with either a hacksaw or fine-tooth saw to make field fabrication a snap. And it's equally easy to couple components with either Carlon® primer and PVC cement or non-metallic push rivets.

Rugged Yet Lightweight.

UV-stabilized, high-impact resistant PVC provides a strong, durable, non-corrosive, non-conductive housing for wire and cable. At the same time, components are so light and easy to handle that installation can be done by one person.



Application Flexibility.

Wireway and trough are suitable for a wide range of applications, from the most demanding commercial and industrial uses, including food service companies and chemical plants, to communication and computer facilities. Both wireway and trough can be used on walls, ceilings or across supports.

A Complete Non-Metallic System.

Both wireway and trough are available in 2" x 2", 3" x 3", 4" x 4" and 6" x 6" dimensions. Wireway comes cut in easy-to-use 10' lengths for larger jobs, and for tighter spaces, we offer specific lengths of wiring trough to fit distances of 1' to 10'. Both can be used with our non-metallic enclosures, conduit and fittings to create a total non-metallic wire and cable management system far superior to metal counterparts.



Fastening Systems — Wiring Duct & Wiring Trough



No Wires to Pull.

Once your wireway or trough is installed, just lay your wire and cable in, pop the cover on and you're done. It's as easy as that, and that's a lot easier than pulling wire or cable.

Easy to Rewire.

Clip-on cover design enables easy access for adding or removing wire and cable after initial installation.



Improved NEMA 12 Wireway End Caps.

Our new wireway end caps are now made with pre-installed adhesive-backed gaskets. This new design makes them easier to use and also qualifies them for a NEMA 12 rating.

Carlton® Wiring Trough and Accessories

Wire Safe® Wireway

CAT. NO.	OUTSIDE NOMINAL DIMENSIONS (IN.)	LENGTH (FT.)	STD. CTN.	STD. WT. (LBS.) PER 10'
17011	2 x 2	10	1	4.7
17013	3 x 3	10	1	11.2
17015	4 x 4	10	1	11.2
17017	6 x 6	10	1	21.4

Note: Endcaps are not supplied with this series.

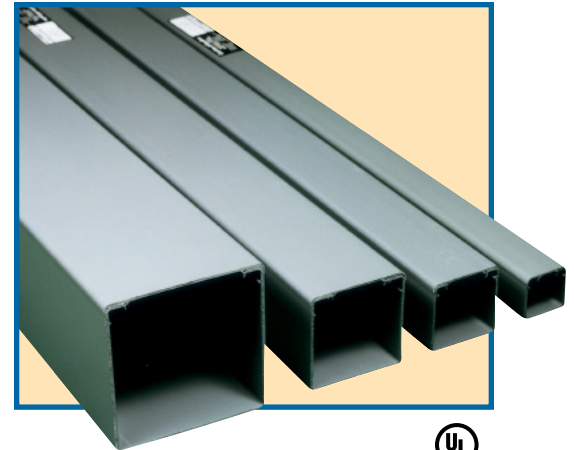

Wire Safe® Wiring Trough

CAT. NO.	OUTSIDE NOMINAL DIMENSIONS (IN.)	STD. CTN.	STD. WT. (LBS.)
12" Trough			
18111	2 x 2	1	.6
18113	3 x 3	1	1.0
18115	4 x 4	1	1.4
18117	6 x 6	1	3.1
24" Trough			
18211	2 x 2	1	1.1
18213	3 x 3	1	1.8
18215	4 x 4	1	2.6
18217	6 x 6	1	5.3
36" Trough			
18311	2 x 2	1	1.5
18313	3 x 3	1	2.6
18315	4 x 4	1	3.7
18317	6 x 6	1	7.4
48" Trough			
18411	2 x 2	1	2.0
18413	3 x 3	1	3.3
18415	4 x 4	1	4.8
18417	6 x 6	1	9.6
60" Trough			
18511	2 x 2	1	2.5
18513	3 x 3	1	4.1
18515	4 x 4	1	5.9
18517	6 x 6	1	11.7
72" Trough			
18611	2 x 2	1	2.9
18613	3 x 3	1	4.9
18615	4 x 4	1	7.1
18617	6 x 6	1	13.8
120" Trough			
18011	2 x 2	1	4.8
18013	3 x 3	1	8.1
18015	4 x 4	1	11.6
18017	6 x 6	1	22.4

All wiring trough is made to order and is supplied with a pair of end caps.

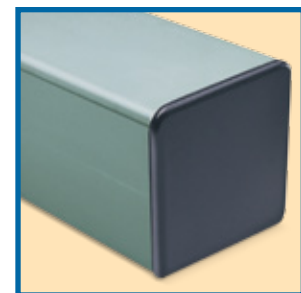
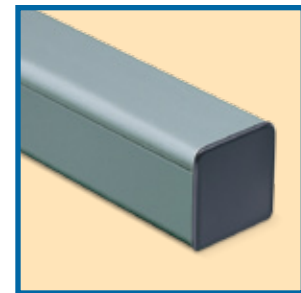
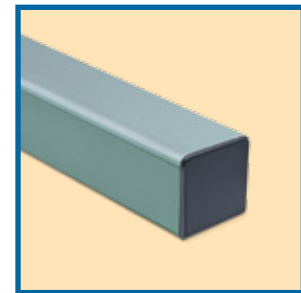

Carlon® Wiring Trough and Accessories

 Except where noted by ►
E151021

Wire Safe® Fittings

Flat Cross (Clip-On Cover)

CAT. NO.	SIZE (IN.)	STD. CTN.	STD. WT. (LBS.)
EGFCJ *	2 x 2	1	.5
EGFCL *	3 x 3	1	1.3
EGFCN †	4 x 4	1	1.7
EGFCR †	6 x 6	1	4.8

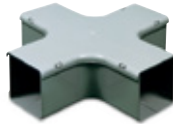

90° Bend Internal Cover (Clip-On Cover)

CAT. NO.	SIZE (IN.)	STD. CTN.	STD. WT. (LBS.)
EGLIJ *	2 x 2	1	.3
EGLIL †	3 x 3	1	.7
EGLIN †	4 x 4	1	1.1
EGLIR †	6 x 6	1	3.0

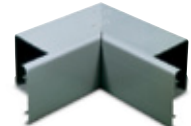

90° Bend Flat Cover (Clip-On Cover)

CAT. NO.	SIZE (IN.)	STD. CTN.	STD. WT. (LBS.)
EGLFJ *	2 x 2	1	.3
EGLFL *	3 x 3	1	.6
EGLFN †	4 x 4	1	1.1
EGLFR †	6 x 6	1	3.3



Tee Flat Cover (Clip-On Cover)

CAT. NO.	SIZE (IN.)	STD. CTN.	STD. WT. (LBS.)
EGTFJ *	2 x 2	1	.4
EGTFL *	3 x 3	1	.9
EGTFN †	4 x 4	1	1.4
EGTFR †	6 x 6	1	3.8

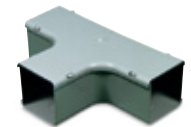

90° Bend External Cover (Clip-On Cover)

CAT. NO.	SIZE (IN.)	STD. CTN.	STD. WT. (LBS.)
EGLEJ *	2 x 2	1	.3
EGLEL †	3 x 3	1	.8
EGLEN †	4 x 4	1	1.2
EGLER †	6 x 6	1	3.3

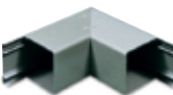

Tee External Cover (Clip-On Cover)

CAT. NO.	SIZE (IN.)	STD. CTN.	STD. WT. (LBS.)
EGTEJ †	2 x 2	1	.4
EGTEL †	3 x 3	1	.9
EGTEN †	4 x 4	1	1.4
EGTER †	6 x 6	1	3.8

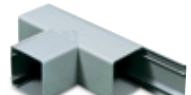

Flange

CAT. NO.	SIZE (IN.)	STD. CTN.	STD. WT. (LBS.)
EGFJ ►	2 x 2	10	1.1
EGFL ►	3 x 3	10	1.4
EGFN ►	4 x 4	10	2.2
EGFR ►	6 x 6	10	3.0



Internal Coupling

CAT. NO.	SIZE (IN.)	STD. CTN.	STD. WT. (LBS.)
EGCIJ ►	2 x 2	10	1.3
EGCIL ►	3 x 3	10	2.2
EGCIN ►	4 x 4	10	2.5
—	6 x 6	N/A	N/A



End Cap (UL NEMA 12 Rated)

CAT. NO.	SIZE (IN.)	STD. CTN.	STD. WT. (LBS.)
EGSEJ *	2 x 2	10 Pair	.6
EGSEL *	3 x 3	10 Pair	.9
EGSEN *	4 x 4	10 Pair	1.6
EGSER ††	6 x 6	10 Pair	5.0



Push Rivets

CAT. NO.	SIZE (IN.)	STD. CTN.	STD. WT. (LBS.)
EGPR ►	N/A	200	.4



External Coupling

CAT. NO.	SIZE (IN.)	STD. CTN.	STD. WT. (LBS.)
EGCEJ	2 x 2	10	1.3
EGCEL	3 x 3	10	2.2
EGCEN	4 x 4	10	2.5
EGCER	6 x 6	10	7.8



Hangers

CAT. NO.	SIZE (IN.)	STD. CTN.	STD. WT. (LBS.)
EGSBJ ►	2 x 2	10	.9
EGSBL ►	3 x 3	10	1.3
EGSBN ►	4 x 4	10	1.9
EGSBR ►	6 x 6	10	2.8



* Molded fitting — couplings not needed

† Fabricated fitting — order couplings separately

†† No coupling is required for 6" fabricated end cap

Wiring Trough Technical Information

Installation Instructions

Description.

Carlon® Wire Safe® Wireway and Wiring Trough is manufactured from extruded PVC. The standard color is gray. The wireway consists of a base channel that is formed to receive a clip-on cover. Wiring troughs include a pair of ready-to-install end caps.

Cover Installation and Removal.

The cover can be installed by exerting hand pressure along its front face in such a manner as to engage and clip projections on the side walls of the base channel. The cover can be removed by inserting a tool (i.e., a screwdriver shaft) into one end of the wireway enclosure and exerting pressure against the underside of the cover, which is then "peeled off" from the base.

Wireway Fittings.

Fittings enable the wireway to be positioned around corners and enable tees and crosses to be created without detracting from the protective characteristics. Interconnecting pieces can be assembled using couplings and rivets or cement as necessary.

Molded fittings do not require couplings because they fit on the exterior of the wireway. However, primer and solvent cement are needed. See cementing instructions on the following page.

Fabricated fittings do require internal or external couplings, and these must be ordered separately. To install fittings, a 3/32"-diameter hole should be drilled in the wireway to match the external coupling hole. A push rivet should be used to connect the two pieces. To connect an internal coupling to the inside of a fitting, use Carlon® Quick-Set Clear Cement.

Applications.

These systems are designed for use in commercial and industrial areas. They may be used for the containment of electrical wiring/cables for power and lighting circuits and also communication and computer facilities. They are suitable for mounting on the surface of walls or ceilings or suspended across suitably positioned supports. Ambient temperatures should not exceed 122° F.

Installation.

1. Mark the surface upon which the wireway is to be mounted.
2. Measure the run and identify position of fittings.
3. Remove cover from wireway, starting at one end, with a peeling action (use of a screwdriver or similar lever is recommended).
4. Drill mounting holes through base at 36" centers maximum. To evenly distribute the load, drill two rows of mounting holes adjacent to each wall of the wireway.
5. The holes in the wireway should be drilled oversize to enable expansion. Mount washers under the head of the mounting device. Do not fully tighten the mounting head.
6. Mount the wireway using screws or bolts.
7. Affix the wireway cover by aligning it to the wireway base. Starting at one end, press the cover into its engaged position.
8. Overlap the cover to the base joint to improve rigidity of the joint.

Engineering Specifications

Code Approvals.

Carlon® Wire Safe® Wireway and Wiring Trough is recognized by the current National Electrical Code®, Article 378, for non-metallic wireways. It is UL Listed for electrical wiring up to 600 volts. UL File Numbers: UL E151021.

Specification for Carlon® Wire Safe Wireway and Wiring Trough.

- The wireway and wiring troughs shall be Carlon® Wire Safe Wireway and Wiring Trough.
- The Carlon® Wire Safe Wireway and Wiring Trough shall provide protection for electrical, low-voltage, data and communication wiring or cables.
- The Carlon® Wire Safe Wireway and Wiring Trough shall be listed and installed per the NEC® Article 378 for non-metallic wireways.
- The Carlon® Wire Safe Wireway and Wiring Trough shall be manufactured from gray precision-extruded Polyvinyl Chloride (PVC) meeting UL 94 V-0 requirements and shall be suitable for field painting.
- The Carlon® Wire Safe Wireway and Wiring Trough shall include base, cover, fittings, etc.
- The Carlon® Wire Safe Wireway and Wiring Trough shall provide all fittings required to form a complete, integrated surface raceway system. End caps shall be gasketed and shall have a NEMA Type 12 rating.

- The Carlon® Wire Safe Wireway and Wiring Trough shall provide raceway with the following cross sectional areas:

1. 2 x 2 — 3.165 in. ² (20.4 cm ²)	3. 4 x 4 — 13.694 in. ² (88 cm ²)
2. 3 x 3 — 7.378 in. ² (47 cm ²)	4. 6 x 6 — 31.871 in. ² (205 cm ²)

Fittings.

Internal and external elbow shall be a fitting cover that snaps onto the main base. Flat elbows and flat tees shall be a fitting cover that snaps on to the main base. End caps shall be gasketed and NEMA Type 12 rated.

Installation.

Install in accordance with the manufacturer's instructions, NFPA 70 and NEC® standard. Install base, cover, fittings, accessories, etc., as necessary for a complete system.

NEC and National Electrical Code are registered trademarks of the National Fire Protection Association, Inc.

Wiring Trough Technical Information

Cementing Instructions

1. Make a square cut using a miter box or precisely marked line on the wireway to provide a smooth connection.
2. Make certain surfaces to be bonded are free of dirt, dust, etc., by wiping them clean with a rag and by removing sawcut burrs with a knife or rasp.
3. With a dauber, place a coating of Carlon® Clear Primer on the wireway and its mating parts. Thoroughly coat the surfaces to be mated.
4. Allow the Carlon® Clear Primer a few seconds to soften the PVC surface (the time may need to be adjusted depending upon the temperature).
5. Apply a complete coating of Carlon® Quick-Set Clear Cement to matching ends that will be joined.
6. Hold the parts in position by exerting pressure on the surfaces with clamps.
7. Allow 15 minutes or more before removing clamps.

Expansion And Contraction

Wireway will expand or contract with variations in temperature. To compensate for this expansion and contraction, during installation leave a .25" gap at joint, glue only one side of internal coupling or use external coupling with push rivets. All mounting holes should be drilled oversize and fasteners should not be tightened fully to allow for expansion and contraction.

Materials

PVC Homopolymer (ASTM F1784)	minimum cell class 12354B
Specific Gravity (ASTM D792)	1.46
Thermal Conductivity (ASTM C177)	1.3 BTU/hr./ft. ² /°F/in.
Heat-Deflection Temperature @ 264 psi (ASTM D648)	70° C
Tensile Strength (ASTM D638)	6000 psi
Flammability (UL 94)	V-0

Physical Properties

SIZE (IN.)	CRUSH STRENGTH ¹ (LBS.)	IMPACT STRENGTH ² (FT.-LBS.)
2 x 2	650	40
3 x 3	500	30
4 x 4	500	40
6 x 6	600	50

- 1 — Load on 6" long sample just prior to wall buckling; fully recoverable.
 2 — 5-lb. weight with 1¼" dia. face at 73° F.

Dimensions

OUTSIDE NOMINAL SIZE (IN.)	OUTSIDE ACTUAL SIZE (IN.)	INSIDE HEIGHT (IN.)	INSIDE WIDTH (IN.)	INSIDE AREA (IN. ²)	WIREWAY THICKNESS (IN.)	COVER THICKNESS (IN.)	WT./FT. (LB./FT.)
2 x 2	1.97 x 1.97	1.8	1.79	3.31	.09	.08	.6
3 x 3	2.96 x 2.96	2.8	2.76	7.94	.10	.08	.85
4 x 4	3.94 x 3.94	3.75	3.72	14.39	.11	.08	1.48
6 x 6	5.91 x 5.91	5.67	5.67	13.48	.12	.12	2.29

All information represents typical values and does not represent a minimum performance specification.

Clear Primer

CAT. NO.	STANDARD SIZE	STD. CTN.	STD. WT. (LBS.)
VC9903	Pint, Dauber Top	24	27.0
VC9902	Quart, Dauber Top	12	25.0

Cement and primer not needed for end caps.

All-Weather Quick-Set Clear Cement

CAT. NO.	STANDARD SIZE	STD. CTN.	STD. WT. (LBS.)
VC9984	Half-Pint, Dauber Top	10	7.0
VC9983	Pint, Dauber Top	24	30.0
VC9982	Quart, Dauber Top	12	29.0
VC9981P	Gallon, Pour Top	6	54.0

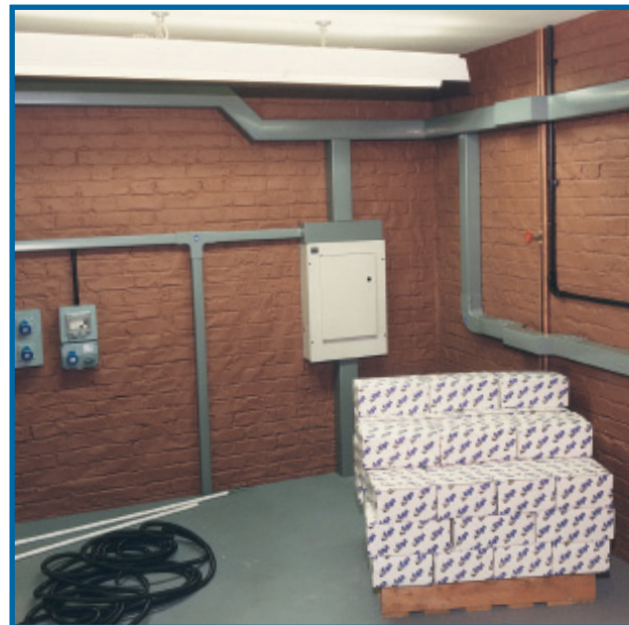

Wiring Trough Technical Information

Wire Fill Chart

CONDUCTOR SIZE AWG/KCMIL	AREA OF CONDUCTOR (SQ. IN.)				WIRE SAFE® WIREWAY SIZE AND MAXIMUM NUMBER OF CONDUCTORS ALLOWED (AREAS SHOWN ARE 20% OF THE FULL INTERIOR CROSS SECTIONAL AREA OF THE WIREWAY)															
	A	B	C	D	2 x 2 (.6 IN. ²)				3 x 3 (1.5 IN. ²)				4 x 4 (2.7 IN. ²)				6 x 6 (6.4 IN. ²)			
	RFH-2, RH, RHH, RHW***, SF-2****	TF, THW, TW†	TFN, THHN, THWN	XHHW, ZW††	A	B	C	D	A	B	C	D	A	B	C	D	A	B	C	D
#18 AWG	.0167	.0088	.0062	—	36	68	96	—	89	170	241	—	161	306	435	—	383	727	1032	—
#6 AWG	.0196	.0109	.0079	—	31	55	76	—	76	137	189	—	137	247	341	—	326	587	810	—
#14 AWG	.0230	.0135	.0087	—	26	44	69	—	65	111	172	—	117	200	310	—	278	474	735	—
#14 AWG	.0327*	—	—	—	18	—	—	—	45	—	—	—	82	—	—	—	195	—	—	—
#14 AWG	—	.0206†	—	.0131	—	29	—	46	—	72	—	114	—	131	—	206	—	310	—	488
#12 AWG	.0278	.0172	.0117	—	21	35	51	—	53	87	128	—	97	156	230	—	230	372	547	—
#12 AWG	.0384*	—	—	—	16	—	—	—	39	—	—	—	70	—	—	—	166	—	—	—
#12 AWG	—	.0252†	—	.0167	—	24	—	36	—	59	—	89	—	107	—	161	—	253	—	383
#10 AWG	.0460	.0222	.0184	—	13	27	33	—	32	67	81	—	58	121	146	—	139	288	347	—
#10 AWG	—	.0311	—	.0216	—	19	—	28	—	48	—	69	—	86	—	125	—	205	—	296
#8 AWG	.0845	.0471	.0373	—	7	13	16	—	17	31	40	—	31	57	72	—	75	135	171	—
#8 AWG	—	.0598†	—	.0456	—	10	—	13	—	25	—	32	—	45	—	59	—	107	—	140
#6 AWG	.1238	.0819	.0519	.0625	4	7	11	10	12	18	28	24	21	32	52	43	51	78	123	102
#4 AWG	.1605	.1087	.0845	.0845	4	6	7	7	9	13	17	17	16	24	31	31	39	58	75	75
#3 AWG	.1817	.1263	.0995	.0995	3	5	6	6	8	11	15	15	14	21	27	27	35	50	64	64
#2 AWG	.2067	.1473	.1182	.1182	3	4	5	5	7	10	12	12	13	18	22	22	30	43	54	54
#1 AWG	.2715	.2027	.1590	.1590	2	3	4	4	5	7	9	9	9	13	16	16	23	31	40	40
1/0 AWG	.3107	.2367	.1893	.1893	2	2	3	3	4	6	7	7	8	11	14	14	20	27	33	33
2/0 AWG	.3578	.2781	.2265	.2265	1	2	2	2	4	5	6	6	7	9	11	11	17	23	28	28
3/0 AWG	.4151	.3288	.2715	.2715	1	1	2	2	3	4	5	5	6	8	9	9	15	19	23	23
4/0 AWG	.4840	.3904	.3278	.3278	1	1	1	1	3	4	4	4	5	6	8	8	13	16	19	19
250 kcmil	.5917	.4877	.4026	.4026	1	1	1	1	2	3	3	3	4	5	6	6	10	13	15	15
300 kcmil	.6837	.5581	.4669	.4669	—	1	1	1	2	2	3	3	3	4	5	5	9	11	13	13
350 kcmil	.7620	.6291	.5307	.5307	—	—	1	1	1	2	2	2	3	4	5	5	8	10	12	12
400 kcmil	.8365	.6969	.5931	.5931	—	—	1	1	1	2	2	2	3	3	4	4	7	9	10	10
500 kcmil	.9834	.8316	.7163	.7163	—	—	—	—	1	1	2	2	2	3	3	3	6	7	8	8
600 kcmil	1.1940	1.0261	.8791	.9043	—	—	—	—	1	1	1	1	2	2	3	3	5	6	7	7
700 kcmil	1.3355	1.1575	1.0011	1.0297	—	—	—	—	1	1	1	1	2	2	2	2	4	5	6	6
750 kcmil	1.4082	1.2252	1.0623	1.0936	—	—	—	—	1	1	1	1	1	2	2	2	4	5	6	5
800 kcmil	1.4784	1.2908	1.1234	1.1499	—	—	—	—	1	1	1	1	1	2	2	2	4	4	5	5
900 kcmil	1.6173	1.4208	1.2449	1.2668	—	—	—	—	—	1	1	1	1	1	2	2	3	4	5	5
1000 kcmil	1.7530	1.5482	1.3623	1.3893	—	—	—	—	—	—	1	1	1	1	1	1	3	4	4	4
1250 kcmil	2.2062	1.9532	—	1.7671	—	—	—	—	—	—	—	—	1	1	—	1	2	3	—	3
1500 kcmil	2.5475	2.2751	—	2.0612	—	—	—	—	—	—	—	—	1	1	—	1	2	2	—	3
1750 kcmil	2.8832	2.5930	—	2.3779	—	—	—	—	—	—	—	—	—	1	—	1	2	2	—	2
2000 kcmil	3.2079	2.9013	—	2.6590	—	—	—	—	—	—	—	—	—	—	—	1	1	2	—	2

* Dimensions of RHH and RHW.

*** Dimensions of RHH and RHW without outer covering are the same as THW No. 18 through No. 10, solid as well as No. 8 and larger, stranded.

† Dimensions of THW in sizes No. 14 through No. 8. No. 6 THW and larger are same dimension as TW.

†† No. 14 through No. 2.

Notes:

1) The ampacities of the conductors shall be reduced as shown in the table below.

2) Refer to the National Electrical Code® for ambient temperature correction factors.

NUMBER OF CONDUCTORS	COLUMN A — PERCENT OF VALUES IN TABLES AS ADJUSTED FOR AMBIENT TEMPERATURE IF NECESSARY	NUMBER OF CONDUCTORS	COLUMN B** — PERCENT OF VALUES IN TABLES AS ADJUSTED FOR AMBIENT TEMPERATURE IF NECESSARY
4 through 6	80	4 through 6	80
7 through 9	70	7 through 9	70
10 through 24*	70	10 through 20	50
25 through 42*	60	21 through 30	45
43 and above*	50	31 through 40	40
—	—	41 through 60	35

* These factors include the effects of a load diversity of 50 percent. ** No diversity.