

Metenova Mixer ZG3 Tank Plate

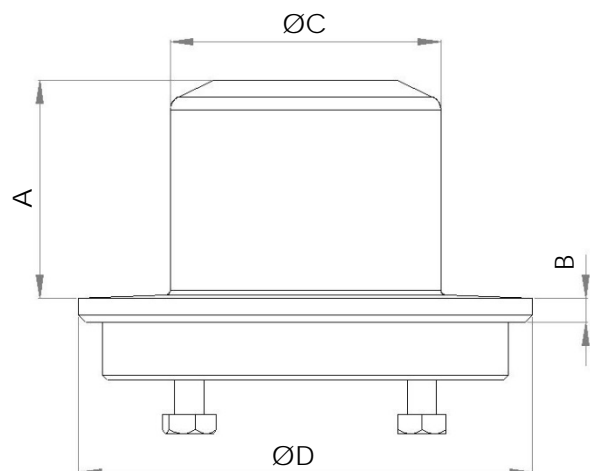

Part #	Description
ZG12506-E00206	ZG3 Tank Plate AL6XN Welded

General information

A mm (in)	B mm (in)	ØC mm (in)	Welding Diameter ØD mm (in)	Weight kg (lb)
45 (1.77)	5 (0.20)	56 (2.20)	94 (3.70)	1.4 (3.1)

Material:	AL6XN ASME SB-691
Certificate:	3.1
Surface Roughness:	Ra ≤ 0.5 µm (20 µin)
Surface Treatment:	Manually polished. Non animal origin polishing compounds are used.
Operating Temp:	5°C - 150°C (41°F - 302°F)
pH Range:	1 - 14
Design Pressure:	-1 - 7 barg (-14.7 - 103 psig)

- Items are individually packed and for traceability purposes marked with item & id no.
- Metenova Quality Assurance System ensures the quality and traceability at all stages of the process.