

# Metenova Mixer ZG7 Tank Plate

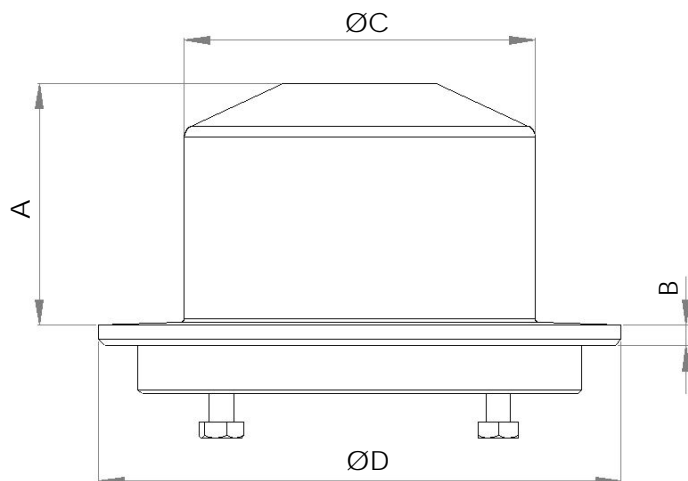

Part #	Description
ZG23506-B00288	ZG7 Tank Plate 904L/1.4539 Welded

## General information

A mm (in)	B mm (in)	ØC mm (in)	Welding Diameter ØD mm (in)	Weight kg (lb)
60 (2.36)	5 (0.20)	87 (3.42)	129.5 (5.1)	4.2 (9.2)

Material:	Stainless Steel 904L/1.4539 ASME SB-649 EN10272 (PED)
Certificate:	3.1
Surface Roughness:	Ra ≤ 0.5 µm (20 µin)
Surface Treatment:	Manually polished. Non animal origin polishing compounds are used.
Operating Temp:	5°C - 150°C (41°F - 302°F)
pH Range:	1 - 14
Design Pressure:	-1 - 10 barg (-14.7 - 145 psig)

- Items are individually packed and for traceability purposes marked with item & id no.
- Metenova Quality Assurance System ensures the quality and traceability at all stages of the process.