

Metenova Mixer ZG9 Drive Unit

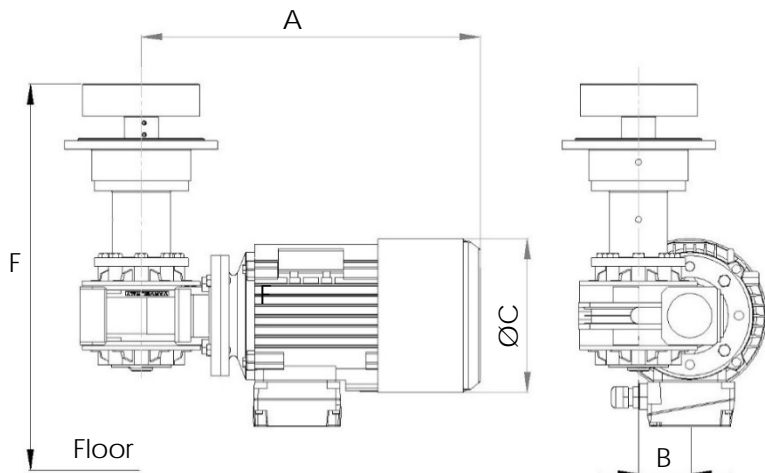

Option 1: RPM Sensor, Mix Head

Option 2: RPM Sensor, Shaft reading

Option 3: Lowering Device



Part #	Description	
ZG14502-F00432	ZG9 Drive Unit AC, E100, IE3	
ZG00014-03083	RPM Sensor, Mix Head	Option 1
ZG00014-03193	RPM Sensor, Shaft	Option 2
ZG14502-02011	ZG9 Lowering Device E100	Option 3

A mm (in)	B mm (in)	ØC mm (in)	F mm (in)	Weight kg (lb)
397 (15.63)	60 (2.36)	180 (7.1)	500 (19.7)	32.0 (70.4)

Motor: 1.5 kW/ 2.0 hp @ 50 Hz / 1.8 kW/ 2.4 hp @ 60 Hz (4-pole - 7:1 Gear Box)
Voltage: Δ230 / Y400 VAC @ 50Hz / Y460 VAC @ 60Hz (±5%)
Current: 6.0A @ 230V/50Hz - 3.4A @ 400V/50Hz - 3.4A @ 460V/60Hz
Efficiency Performance Class: IE3
Thermistors: 2
Certified: CE / C-UL-US
Protection class: IP 55
Environment temp: 0°C - 40°C (32°F - 104°F)
Min - Max rpm: 24 - 245
Color: In compliance with FDA
Gear box oil: Food grade in compliance with FDA



- VFD with soft start must be used when operating the mixer.
- Items are individually packed and for traceability purposes marked with item & id no.
- Metenova Quality Assurance System ensures the quality and traceability at all stages of the process.

Option 1: RPM Sensor, Mix Head

Pulses/turn: 1
 Output function: 3-wire, NO contact PNP
 Indicator: Yellow LED
 Temperature range: -25°C-70°C (-13°F-158°F)
 Operating voltage: 10..65 VDC
 Protection class: IP67

Option 2: RPM Sensor, Shaft

Pulses/turn: 4
 Output function: 4-wire, NO/NC contacts PNP
 Indicator: Yellow LED
 Temperature range: -25°C-70°C (-13°F-158°F)
 Operating voltage: 10..30 V
 Protection class: IP67

Option 3: Lowering Device

Allows preventative maintenance of Mix Head and Male Post without having to remove the Drive Unit from the tank.