





RY Series Miniature Relays

DPDT and 4PDT contacts (3A) Bifurcated contacts are also available

The RY series are general purpose miniature relays with a 3A contact capacity. A wide variety of terminals styles and coil voltages meet a wide range of applications. All 4PDT have arc barriers. The 4PDT also available with reverse polarity diode and LED.

Applicable Standards	Mark	Certification Organization/ File No.
UL508		UL recognized, File No. E55996
CSA C22.2 No. 14		CSA File No. LR35144
EN61810-1		TÜV SÜD
		EU Low Voltage Directive



Plug-in Terminal

Terminal	Style	DPDT		4PDT	
		Part No.	Coil Voltage Code *	Part No.	Coil Voltage Code *
Standard	Basic	RY2S-U* ★	AC6, AC12, AC24, AC50, AC100, AC110, AC115, AC120, AC200, AC220, AC230, AC240 DC6, DC12, D24, DC48, DC100, DC110	RY4S-U* ★	AC6, AC12, AC24, AC50, AC100-110, AC110-120, AC200-220, AC220-240 DC6, DC12, DC24, DC48, DC100-110
	With Indicator	RY2S-UL* ★		RY4S-UL* ★	
	With Reverse Polarity Indicator	—		RY4S-UL1* ★	
	With Check Button	—		RY4S-UC* ★	
	With Indicator and Check Button	—		RY4S-ULC* ★	
	Top Bracket Mounting	RY2S-UT* ★	RY4S-UT* ★		
	With Diode (DC coil only)	RY2S-UD* ★	DC6, DC12, DC24, DC48, DC100, DC110	RY4S-UD* ★	DC6, DC12, DC24, DC48, DC100-110
	With Reverse Polarity Diode (DC coil only)	—		RY4S-UD1*	
	With Indicator and Diode (DC coil only)	RY2S-ULD*		RY4S-ULD* ★	
	With Indicator and Reverse Polarity Diode (DC coil only)	—		RY4S-UL1D1*	

PC Board Terminal

Terminal	Style	DPDT		4PDT	
		Part No.	Coil Voltage Code *	Part No.	Coil Voltage Code *
Standard	Standard	RY2V-U* ★	AC6, AC12, AC24, AC50, AC100, AC110, AC115, AC120, DC6, DC12, DC24, DC48	RY4V-U* ★	AC6, AC12, AC24, AC50, AC100-110, AC110-120, AC200-220, AC220-240 DC6, DC12, DC24, DC48, DC100-110
	With Indicator	RY2V-UL* ★		RY4V-UL* ★	
	With Diode (DC coil only)	RY2V-UD* ★	DC6, DC12, DC24, DC48, DC100, DC110	—	—

Part numbers marked with ★ in the tables above are UL-recognized, CSA-certified, and TÜV-approved.

Part No. Development

When ordering, specify the Part No. and coil voltage code.

(Example) **RY4S-U** | **AC100-110**
 Part No. | Coil Voltage Code

Ry Series Miniature Relays

Coil Ratings

Rated Voltage (V)	Rated Current (mA) ±15% at 20°C						Coil Resistance (Ω) ±10% at 20°C		Operation Characteristics (against rated values at 20°C)		
	DPDT	4PDT	50Hz		60Hz		DPDT	4PDT	Max. Continuous Applied Voltage	Min. Pickup Voltage	Dropout Voltage
AC (50/60Hz)	6	6	170	240	150	200	18.8	9.34	110%	80% maximum	30% minimum
	12	12	86	121	75	100	76.8	39.3			
	24	24	42	60.5	37	50	300	152			
	50	50	20.5	28.9	18	24	1,280	676			
	100	100-110	10.5	10.3-11.8	9	9.1-10.0	5,220	3,360			
	110	—	9.6	—	8.4	—	6,950	—			
	115	110-120	8.9	9.4-10.8	7.8	8.0-9.2	7,210	4,290			
	120	—	8.6	—	7.5	—	8,100	—			
	200	200-220	5.6	5.1-5.9	4.9	4.3-5.0	21,442	13,690			
	220	—	4.7	—	4.1	—	25,892	—			
	230	220-240	4.7	4.7-5.4	4.1	4.0-4.6	26,710	18,820			
240	—	4.9	—	4.3	—	26,710	—				
DC	DPDT	4PDT	DPDT		4PDT		DPDT	4PDT	110%	80% maximum	10% minimum
	6	6	128		150		47	40			
	12	12	64		75		188	160			
	24	24	32		36.9		750	650			
	48	48	18		18.5		2,660	2,600			
	100	100-110	10		8.2-9.0		10,000	12,250			
	110	—	8		—		13,800	—			

Contact Ratings

Contact	Continuous Current	Maximum Contact Capacity				
		Allowable Contact Power		Rated Load		
		Resistive Load	Inductive Load	Voltage	Resistive Load	Inductive Load
Standard Contact DPDT 4PDT	3A	660 VA AC 90W DC	176 VA AC 45W DC	110V AC	3A	1.5A
				220V AC	3A	0.8A
				30V DC	3A	1.5A

Note: Inductive load for the rated load — $\cos \phi = 0.3$, $L/R = 7$ ms

Standard Ratings

RY2

UL Ratings (Standard Contact)

Voltage	Resistive	General use
240V AC	3A	0.8A
120V AC	—	1.5A
100V DC	0.2A	0.2A
30V DC	3A	3A

CSA Ratings (Standard Contact)

Voltage	Resistive	General use
240V AC	3A	0.8A
120V AC	3A	1.5A
100V DC	—	0.2A
30V DC	3A	1.5A

TÜV Ratings (Standard Contact)

240V AC	3A
30V DC	3A

AC $\cos \phi = 1.0$,
DC $L/R = 0$ ms

RY4

UL Ratings (Standard Contact)

Voltage	Resistive	General use
240V AC	5A	5A
100V DC	0.2A	0.2A
30V DC	5A	5A

CSA Ratings (Standard Contact)

Voltage	Resistive	General use
240V AC	5A	5A
100V DC	—	0.2A
30V DC	5A	1.5A

TÜV Ratings (Standard Contact)

240V AC	5A
30V DC	5A

AC $\cos \phi = 1.0$,
DC $L/R = 0$ ms

Relays

RJ

RU

RY

RM

RH

RR

RV8H

RF1V

RF2

Sockets

SJ

DF

SU

SF1V

Relay
Sockets

R_Y Series Miniature Relays

Specifications

Contact	Standard Contact	
	DPDT	4PDT
Contact Material	Gold-plated silver	
Contact Resistance *1	50 mΩ maximum	
Minimum Applicable Load	5V DC, 10 mA (reference value)	1V DC, 1 mA (reference value)
Operate Time *2	20 ms maximum	
Release Time *2	20 ms maximum	
Power Consumption (approx.)	AC: 1.1 VA (50 Hz), 1 VA (60 Hz) DC: 0.8W	AC: 1.4 VA (50 Hz), 1.2 VA (60 Hz) DC: 0.9W
Insulation Resistance	100 MΩ minimum (500V DC megger)	
Dielectric Strength	Between live and dead parts: 1500V AC, 1 minute Between contact and coil: 1500V AC, 1 minute *3 Between contacts of different poles: 1500V AC, 1 minute Between contacts of the same pole: 1000V AC, 1 minute	Between live and dead parts: 2000V AC, 1 minute Between contact and coil: 2000V AC, 1 minute Between contacts of different poles: 2000V AC, 1 minute Between contacts of the same pole: 1000V AC, 1 minute
Operating Frequency	Electrical: 1,800 operations/h maximum Mechanical: 18,000 operations/h maximum	
Vibration Resistance	Damage limits: 10 to 55 Hz, amplitude 0.5 mm Operating extremes: 10 to 55 Hz, amplitude 0.5 mm	
Shock Resistance	Damage limits: 1,000 m/s ² Operating extremes: 100 m/s ² (DPDT), 200 m/s ² (4PDT)	
Mechanical Life	50,000,000 operations	
Electrical Life	200,000 operations (220V AC, 3A)	
Operating Temperature *4	-25 to +50°C (no freezing)	
Operating Humidity	45 to 85% RH (no condensation)	
Storage Temperature	-55 to +70°C (no freezing)	
Storage Humidity	45 to 85% RH (no condensation)	
Weight (approx.)	23g	34g

Note: Above values are initial values.

*1: Measured using 5V DC, 1A voltage drop method

*2: Measured at the rated voltage (at 20°C), excluding contact bouncing
Release time of relays with diode: 40 ms maximum

*3: Relays with indicator or diode: 1000V AC, 1 minute

*4: For use under different temperature conditions, refer to Continuous Load Current vs. Operating Temperature Curve.
The operating temperature range of relays with indicator or diode is -25 to +40°C.

Characteristics (Reference Data)

Maximum Switching Capacity

(R_Y2)

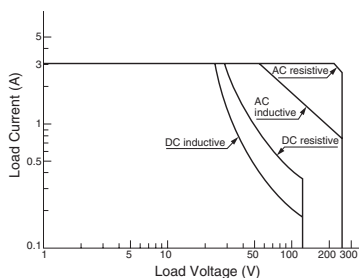

(R_Y4)

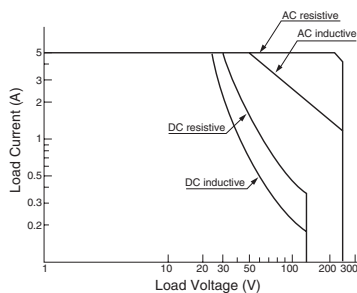

Continuous Load Current vs. Operating Temperature Curve (Basic, With Check Button, and Top Bracket Mounting)

(R_Y2)

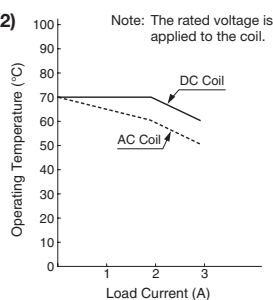

(R_Y4)

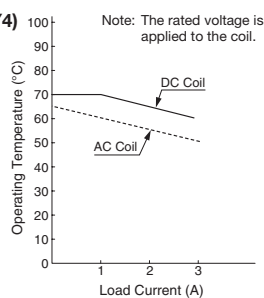

Ry Series Miniature Relays

Electrical Life Curve

**AC Load
(RY2/4)**

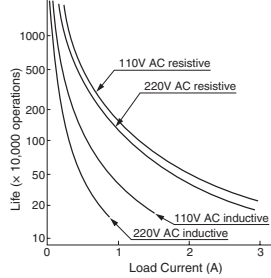

**DC Load
(RY2/4)**

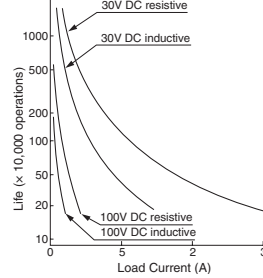

Internal Connection (Bottom View)

Basic (-U, UT)

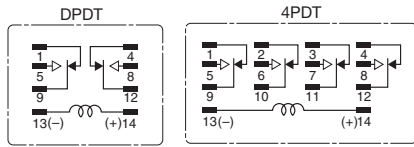

With Check Button

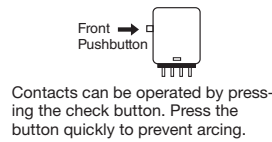

With Indicator and Diode (-ULD)

This type contains an operation indicator and a surge absorber, and has the same height as the basic type.

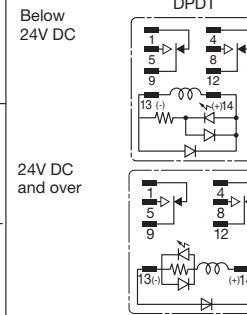

With Indicator (-UL)

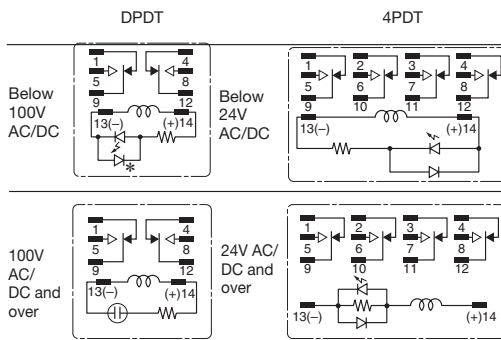

With Indicator (-UL1) (reverse polarity)

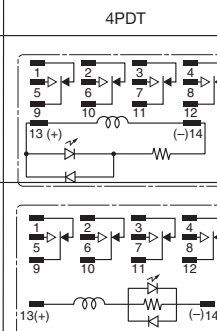

When the relay is energized, the indicator goes on.
* The LED protection diode is not contained in DPDT relays for below 100V DC.

With Diode (-UD)

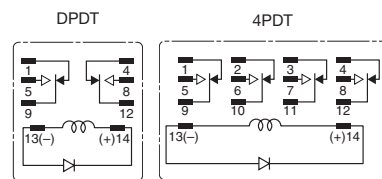

With Diode (-UD1) (reverse polarity)

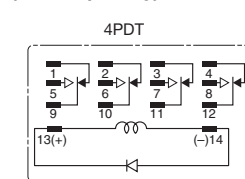

This type contains a diode to absorb the counter emf generated when the coil is deenergized. The release time is slightly longer.

- Diode Characteristics
Reverse withstand voltage: 1,000V
Forward current: 1A

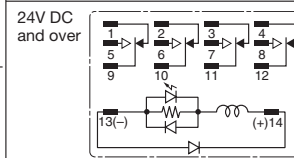

With Indicator and Diode (-UL1D1) (reverse polarity)

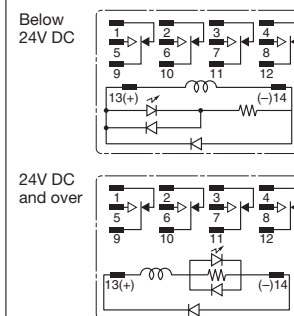

Relays

RJ

RU

RY

RM

RH

RR

RV8H

RF1V

RF2

Sockets

SJ

DF

SU

SF1V

Relay
Sockets

RY Series Miniature Relays

Dimensions

Plug-in Terminal

RY2S-U/RYS2S-UL
RY2S-UD



(Photo: RY2S-U)

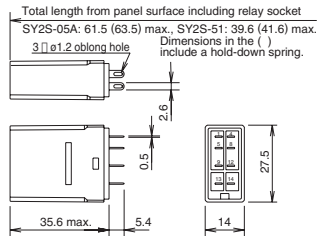

Applicable Socket and Hold-down Spring

Mounting Style	Socket	
	Part No.	Hold-down Spring
DIN Rail Mount Socket	SY2S-05*	SFA-101 SFA-202
Panel Mount Socket	SY2S-51	SY4S-51F1 SFA-301 SFA-302
PC Board Mount Socket	SY2S-61	

RY4S-U/RYS4S-UL/RYS4S-UD/RYS4S-ULD/
RY4S-UL1/RYS4S-UD1/RYS4S-UL1D1



(Photo: RY4S-U)

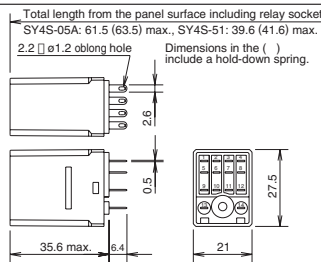

Applicable Socket and Hold-down Spring

Mounting Style	Socket	
	Part No.	Hold-down Spring
DIN Rail Mount Socket	SY4S-05*	SFA-101 SFA-202 SFA-502
Panel Mount Socket	SY4S-51	SY4S-51F1 SFA-301 SFA-302
PC Board Mount Socket	SY4S-61	(SY4S-02F1)

• (SY4S-02F1) is for the relay with check button.

PC Board Terminal

RY2V-U/RYS2V-UL/RYS2V-UD



(Photo: RY2V-U)

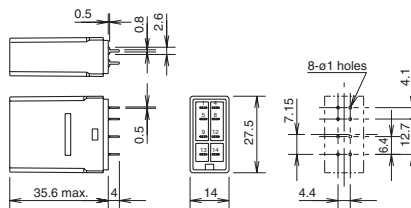

RY4V-U/RYS4V-UL



(Photo: RY4V-U)

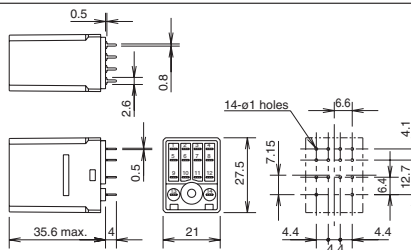

Top Bracket Mounting (Plug-in Terminal)

RY2S-UT

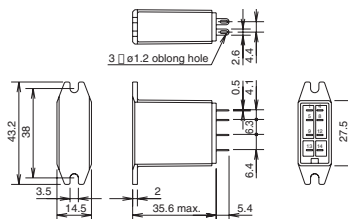

RY4S-UT

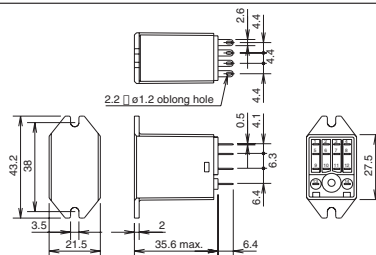

All dimensions in mm.