

Think Automation and beyond...



Ø16 A6/L6

Key Selector Switches (Wave-key Type)

Seven different keys available



Wave-keys are hard to duplicate and provide increased security.



Installed with flush silhouette bezels



IDEC CORPORATION

∅16 A6 Series Key Selector Switches (Wave-key Type)

Unibody 22mm deep, Light duty

- Seven different keys are available.
- Hard-to-duplicate wave-keys
- Gold-clad cross-bar contacts
- IP40 and IP65 (IEC60529)
- UL recognized, CSA certified, EN compliant (EN60947-1, EN60947-5-1)

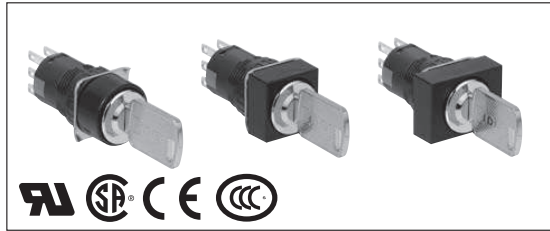

Specifications

Operating Temperature	-25 to +55°C (no freezing)
Storage Temperature	-30 to +80°C
Humidity	45 to 85% RH (no condensation)
Contact Resistance	50 mΩ maximum (initial value)
Insulation Resistance	100 MΩ minimum (500V DC megger)
Dielectric Strength	Between live part and ground: 2000V AC, 1 minute Between terminals of different poles: 2000V AC, 1 minute Between terminals of the same pole: 1000V AC, 1 minute
Vibration Resistance	Operating extremes: 5 to 55 Hz, amplitude 0.75 mm Damage limits: 5 to 55 Hz, amplitude 0.75 mm
Shock Resistance	Operating extremes: 200 m/s ² Damage limits: 500 m/s ²
Mechanical Life	250,000 operations minimum
Electrical Life	100,000 operations minimum (operating frequency 1200 operations/hour)
Degree of Protection	IP40, IP65 (IEC 60529)
Terminal Style	Solder/tab terminal #110
Weight	Approx. 21g (AS6H-2KS2B)

Contact Ratings

Rated Insulation Voltage (Ui)		250V				
Rated Thermal Current (Ith)		3A				
Rated Operating Voltage (Ue)		12V	24V	110V	220V	
Rated Operating Current (Ie)	AC 50/60Hz	Resistive Load (AC-12)	—	—	1.0A	0.5A
		Inductive Load (AC-15)	—	—	0.7A	0.5A
	DC	Resistive Load (DC-12)	1.0A	1.0A	0.2A	—
		Inductive Load (DC-13)	0.7A	0.7A	0.1A	—
Contact Material		Gold-clad silver				

• Minimum applicable load (reference value): 5V AC/DC, 1 mA

Dimensions

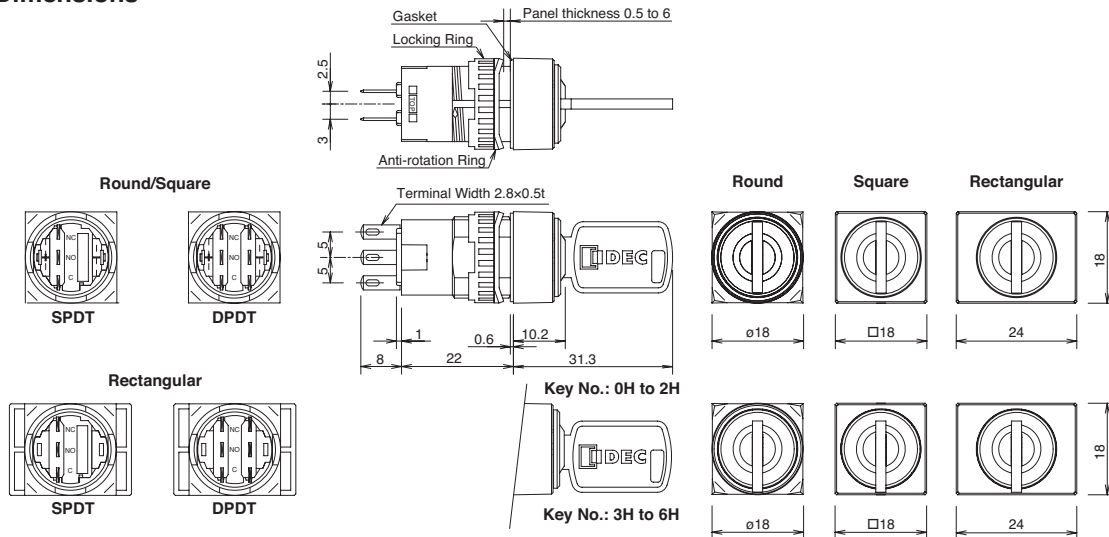

Terminal Arrangement (Bottom View)

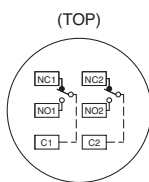

Mounting Hole Layout

• Round/Square

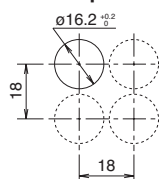

• Rectangular

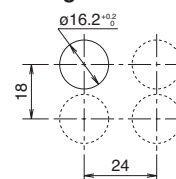

























Note:
Determine mounting centers to ensure easy operation.

All dimensions in mm.

A6 Series Key Selector Switches (Wave-key Type) ø16

A6 Series Key Selector Switches (Wave-key Type)

Package quantity: 1

Shape	Position	Key Retained at ●	Contact	Type No.			
				IP40	IP65		
<p>AS6□</p> <p>Bezel Style M: Round Q: Square H: Rectangular</p>  <p>AS6M (Round)</p>  <p>AS6Q (Square)</p>  <p>AS6H (Rectangular)</p> 	90° 2-position Maintained	A		SPDT	AS6□-2KS1A	AS6□-2KS1PA	
				DPDT	AS6□-2KS2A	AS6□-2KS2PA	
		B		SPDT	AS6□-2KS1B	AS6□-2KS1PB	
				DPDT	AS6□-2KS2B	AS6□-2KS2PB	
		C		SPDT	AS6□-2KS1C	AS6□-2KS1PC	
				DPDT	AS6□-2KS2C	AS6□-2KS2PC	
	90° 2-position Spring return from right	B			SPDT	AS6□-21KS1B	AS6□-21KS1PB
					DPDT	AS6□-21KS2B	AS6□-21KS2PB
		A			DPDT	AS6□-3KS2A	AS6□-3KS2PA
					DPDT	AS6□-3KS2B	AS6□-3KS2PB
					DPDT	AS6□-3KS2C	AS6□-3KS2PC
					DPDT	AS6□-3KS2D	AS6□-3KS2PD
					DPDT	AS6□-3KS2E	AS6□-3KS2PE
					DPDT	AS6□-3KS2G	AS6□-3KS2PG
	45° 3-position Maintained	H			DPDT	AS6□-3KS2H	AS6□-3KS2PH
		B			DPDT	AS6□-31KS2B	AS6□-31KS2PB
					DPDT	AS6□-31KS2D	AS6□-31KS2PD
					DPDT	AS6□-31KS2G	AS6□-31KS2PG
45° 3-position Spring return from right	D			DPDT	AS6□-32KS2C	AS6□-32KS2PC	
				DPDT	AS6□-32KS2D	AS6□-32KS2PD	
				DPDT	AS6□-32KS2H	AS6□-32KS2PH	
45° 3-position Spring return from left	H			DPDT	AS6□-32KS2C	AS6□-32KS2PC	
				DPDT	AS6□-32KS2D	AS6□-32KS2PD	
				DPDT	AS6□-32KS2H	AS6□-32KS2PH	
45° 3-position Spring return two-way	D			DPDT	AS6□-33KS2D	AS6□-33KS2PD	























- Bezel style code: M (round), Q (square), H (rectangular)
 - Key is retained in ● positions and removable in ○ positions.
 - Two keys are supplied.
 - Besides the standard key (key number 0H), six other keys are also available.
- To order other keys, specify the key number as shown below:

AS6M-2KS1PA-1H

↑ (blank): Standard key (0H)
1H to 2H: Reversible key
3H to 6H: Non-reversible key

Note:
Key number is indicated on the key cylinder.
Standard keys do not have a key number indication.

Contact Operation

Key Operator Position and Contact Operation (Top View)						
Position		Contact	↙ Left	↑ Center	↘ Right	
90° 2-position	 Maintained  Spring return from right	SPDT		—		
		DPDT		—		
45° 3-position	 Manual  Spring return from right  Spring return from left  Spring return two-way	DPDT				
						
						
						

∅16 L6 Series Key Selector Switches (Wave-key Type)

Removable contact block allows for single-board control panels

- Seven different keys are available.
- Hard-to-duplicate wave-keys
- Gold-clad or silver cross-bar contacts
- IP65 (IEC60529)
- UL recognized, CSA certified, EN compliant (EN60947-1, EN60947-5-1, TÜV Rheinland)

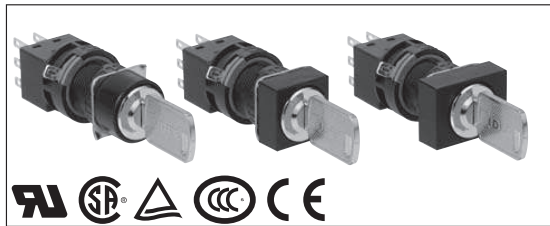

Specifications

Operating Temperature	-25 to +55°C (no freezing)
Storage Temperature	-30 to +80°C
Humidity	45 to 85% RH (no condensation)
Contact Resistance	50 mΩ maximum (initial value)
Insulation Resistance	100 MΩ minimum (500V DC megger)
Electric Shock Protection	Class II (IEC61140)
Dielectric Strength	Between live part and ground: 2500V AC, 1 minute
	Between terminals of different poles: 2500V AC, 1 minute
	Between terminals of the same pole: 1000V AC, 1 minute
Vibration Resistance	Operating extremes: 5 to 55 Hz, amplitude 0.5 mm
	Damage limits: 5 to 55 Hz, amplitude 0.5 mm
Shock Resistance	Operating extremes: 100 m/s ²
	Damage limits: 1000 m/s ²
Mechanical Life	250,000 operations minimum
Electrical Life	100,000 operations minimum (operating frequency 1200 operations/hour)
Degree of Protection	IP65 (IEC 60529)
Terminal Style	Solder/tab terminal #110, PC board terminal
Weight	Approx. 27g (LA3K-2SC6B)

Contact Ratings

• Gold Contact (Switch base: Blue)

Rated Insulation Voltage (Ui)	250V	
Rated Thermal Current (Ith)	3A	
Rated Operating Voltage (Ue)	125V AC	30V DC
Rated Operating Current (Ie)	0.1A	0.1A
Contact Material	Gold-clad silver	

Minimum applicable load (reference value): 5V AC/DC, 1 mA

• Silver Contact (Switch base: Gray)

Rated Insulation Voltage (Ui)	250V				
Rated Thermal Current (Ith)	5A				
Rated Operating Voltage (Ue)	30V	125V	250V		
Rated Operating Current (Ie)	AC 50/60Hz	Resistive Load (AC-12)	—	3A	2A
		Inductive Load (AC-15)	—	2A	1.5A
	DC	Resistive Load (DC-12)	2A	0.4A	—
		Inductive Load (DC-13)	1A	0.2A	—
Contact Material	Silver				

AC inductive load: PF = 0.6 to 0.7
DC inductive load: L/R = 7 ms maximum

Dimensions

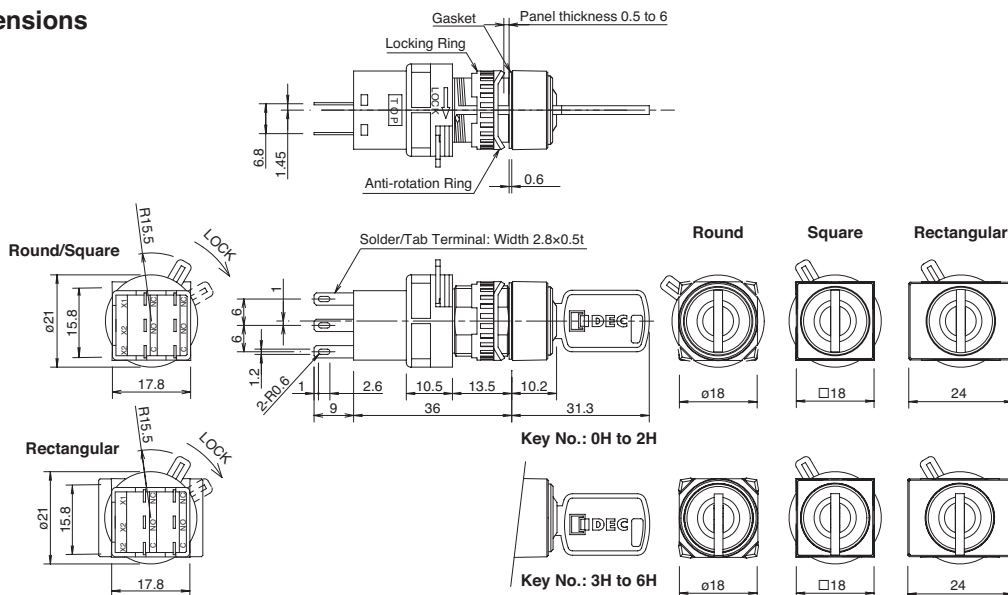

Terminal Arrangement (Bottom View)

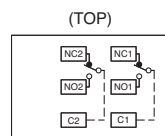

Mounting Hole Layout

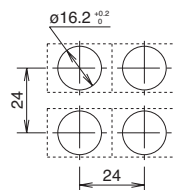





Note:
Determine mounting centers to ensure easy operation.

All dimensions in mm.

L6 Series Key Selector Switches (Wave-key Type) ø16

L6 Series Key Selector Switches (Wave-key Type)

Package quantity: 1

Shape	Position	Key Retained at ●	Contact Material	Contact	Type No.					
					Solder/Tab Terminal	PC Board Terminal				
LA□K Bezel Style 1: Round 2: Square 3: Rectangular  LA1K (Round)  LA2K (Square)  LA3K (Rectangular) 	90° 2-position Maintained	A	●	Gold	SPDT	LA□K-2SC1A	LA□K-2SC1VA			
				Silver	DPDT	LA□K-2SC2A	LA□K-2SC2VA			
			B	●	Gold	SPDT	LA□K-2SC5A	—		
					Silver	DPDT	LA□K-2SC6A	—		
			C	●	Gold	SPDT	LA□K-2SC1B	LA□K-2SC1VB		
					Silver	DPDT	LA□K-2SC2B	LA□K-2SC2VB		
		90° 2-position Spring return from right	B	●	Gold	SPDT	LA□K-2SC5B	—		
					Silver	DPDT	LA□K-2SC6B	—		
				○	Gold	SPDT	LA□K-2SC1C	LA□K-2SC1VC		
					Silver	DPDT	LA□K-2SC2C	LA□K-2SC2VC		
				45° 3-position Maintained	A	●	Gold	DPDT	LA□K-3SC2A	LA□K-3SC2VA
							Silver	DPDT	LA□K-3SC6A	—
	B	●	Gold			DPDT	LA□K-3SC2B	LA□K-3SC2VB		
			Silver			DPDT	LA□K-3SC6B	—		
	C	○	Gold			DPDT	LA□K-3SC2C	LA□K-3SC2VC		
			Silver			DPDT	LA□K-3SC6C	—		
	45° 3-position Spring return from right	D	●		Gold	DPDT	LA□K-3SC2D	LA□K-3SC2VD		
					Silver	DPDT	LA□K-3SC6D	—		
		E	○		Gold	DPDT	LA□K-3SC2E	LA□K-3SC2VE		
					Silver	DPDT	LA□K-3SC6E	—		
		G	○		Gold	DPDT	LA□K-3SC2G	LA□K-3SC2VG		
					Silver	DPDT	LA□K-3SC6G	—		
	45° 3-position Spring return from left	H	●	Gold	DPDT	LA□K-3SC2H	LA□K-3SC2VH			
				Silver	DPDT	LA□K-3SC6H	—			
B		○	Gold	DPDT	LA□K-31SC2B	LA□K-31SC2VB				
			Silver	DPDT	LA□K-31SC6B	—				
D		○	Gold	DPDT	LA□K-31SC2D	LA□K-31SC2VD				
			Silver	DPDT	LA□K-31SC6D	—				
45° 3-position Spring return two-way	G	○	Gold	DPDT	LA□K-31SC2G	LA□K-31SC2VG				
			Silver	DPDT	LA□K-31SC6G	—				
	C	○	Gold	DPDT	LA□K-32SC2C	LA□K-32SC2VC				
			Silver	DPDT	LA□K-32SC6C	—				
	D	○	Gold	DPDT	LA□K-32SC2D	LA□K-32SC2VD				
			Silver	DPDT	LA□K-32SC6D	—				
H	○	Gold	DPDT	LA□K-32SC2H	LA□K-32SC2VH					
		Silver	DPDT	LA□K-32SC6H	—					

- Bezel style code: 1 (round), 2 (square), 3 (rectangular)
- Key is retained in ● positions and removable in ○ positions.
- Two keys are supplied.
- L-shaped lever contact types are also available for collective mounting.
To order L-shaped lever contacts, specify "T" in place of "C" in the Type No.

Example: (Straight lever contact) LA1K-2SC1A (L-shaped lever contact) LA1K-2ST1A

- Besides the standard key (key number 0H), six other keys are also available.
To order other keys, specify the key number as shown below:

LA1K-2SC2VA-1H
 (blank): Standard key (0H)
 1H to 2H: Reversible key
 3H to 6H: Non-reversible key

Note:
Key number is indicated on the key cylinder.
Standard keys do not have a key number indication.

ø16 A6/L6 Series Key Selector Switches (Wave-key Type)

L6 Series Key Selector Switches (Wave-key Type)

Contact Operation

Key Operator Position and Contact Operation (Top View)					
Position		Contact	↙ Left	↑ Center	↘ Right
90° 2-position	Maintained	SPDT		—	
	Spring return from right	DPDT		—	
45° 3-position	Maintained	DPDT			
	Spring return from right				
	Spring return from left				
	Spring return two-way				

Collective Mounting

- The L6 series are available with L-shaped lever contact blocks which allow for collective mounting on 18-mm horizontal centers (round and square types) or 24-mm horizontal centers (rectangular types).

Dimensions

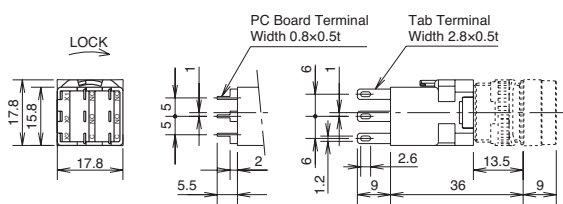

Mounting Hole Layout

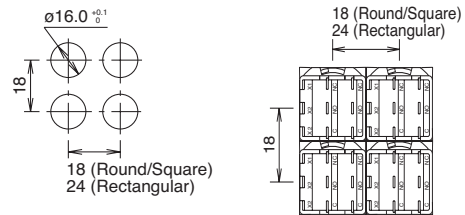

All dimensions in mm.

A6/L6 Series Key Selector Switches (Wave-key Type) Common Information

Accessories

Shape	Material	Type No.	Ordering Type No.	Package Quantity	Remarks
	Metal	LA9Z-SK-□	LA9Z-SK-□PN02	2	Specify a key number in place of □ in the Type No. 0H: Standard key (reversible) 1H to 2H: Reversible key 3H to 6H: Non-reversible key
	Metal (nickel-plated brass)	MT-001	MT-001	1	• Used to tighten the locking ring when installing an A6 or L6 control unit to a panel. • Tighten the locking ring to a torque of 0.88 N·m maximum.

- For other accessories, see A6 and L6 control unit pages in the Industrial Automation Catalog A101.

A6/L6 Series Key Selector Switches (Wave-key Type) ø16

Safety Precautions

- Turn off the power to A6/L6 control units before installation, removal, wiring, maintenance, and inspection. Failure to turn power off may cause electrical shocks or fire hazard.
- For wiring, use wires of proper size to meet the voltage and current requirements. Solder the wires correctly. Improper soldering may cause overheating and create a fire hazard. When using quick connect receptacles, use applicable receptacles of the proper size.

Instructions

Key Selector Switches

Observe the following instructions to prevent malfunction or damage.

- Insert the key to the bottom of the key hole.
- Do not attempt to remove the key from any key retained position.
- Besides the standard key (key number 0H), six other key numbers are available. Use a key of the matching number with the key cylinder. The standard key does not have a key number indication.
- Keys are available in two types.
Key numbers 0H (standard), 1H, and 2H are reversible keys which can be inserted in two ways.
Key numbers 3H, 4H, 5H, and 6H are non-reversible keys. Make sure of correct insertion direction.

Panel Mounting

• A6/L6 series

To install the A6/L6 unit to a panel cut-out, use the optional locking ring wrench (MT-001) and tighten the locking ring to a torque of 0.88 N·m. Do not use pliers and do not tighten the locking ring excessively, otherwise the locking ring may be damaged.

• L6 series

Remove the operator from the contact block, insert the operator into the panel cut-out from the front of the panel, then attach the contact block.

To remove the contact block, turn the locking lever in the direction opposite to the arrow on the housing, and pull out the operator from the contact block.

To install the contact block, align the TOP markings on the contact block and the operator in the same direction, then lock the lever in the direction of the arrow.

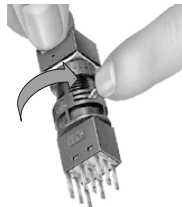

Other Notes

• A6/L6 series

• Operating and storage environment
Make sure that the ambient temperature and humidity are within the rated values.

• Do not use IP40 selector switches in places where the switches are subject to oil and water splashes. In such areas, use IP65 selector switches.

• Microswitch contacts

Do not connect NO and NC contacts of a microswitch to different voltages or different power sources to prevent a dead short-circuit.

• IP65 selector switches

IP65 selector switches are evaluated with conventional cutting and cooling oils, and cannot be used with some special oils. Contact IDEC for resistance against specific oils.

• L6 series

• Operating and storage environment

Make sure that the ambient temperature and humidity are within the rated values.

• Connection

Positive lock connectors and easy-lock connectors can be used on the tab terminals.

• Recommended connectors

Item	Positive-lock Connector (Tyco Electronics)		Easy-lock Connector (Nichifu Co., Ltd.)	
	0.2 to 0.5 mm ²	175412-1	0.2 to 0.3 mm ²	OSS-62852F3
Terminal	0.5 to 1.25 mm ²	174778-1	0.5 to 1.25 mm ²	OSS-62815F3
	174779-1		NET1-28-1P	
Housing	174779-1		NET1-28-1P	

Note: Positive-lock is a registered trademark of Tyco Electronics.

- For other details about operating instructions, see the A6 and L6 pages in the Industrial Control & Automation Catalog A101.

Wiring

Solder the terminal at 350°C within 3 seconds using a 60W soldering iron. Use lead-free Sn-Ag-Cu solder. Use a non-corrosive rosin flux.

When soldering, do not touch the switch housing with the soldering iron. Also, ensure that no tensile force is applied to the terminal. Do not bend the terminal or apply excessive force to the terminal.

Flush Silhouette A6/L6 Series Accessories

Flush silhouette bezels for A6/L6 series miniature control units protrude only 2 mm from the panel surface to provide stylish panel appearance. Smaller protrusion reduces dust accumulation to increase cleanliness.

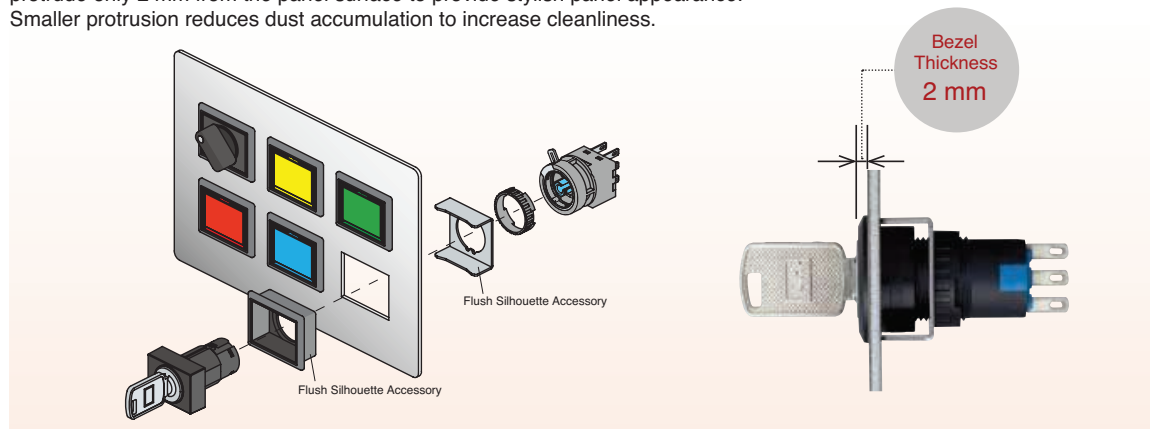





Flush Silhouette Bezel

- A6/L6 series control units can be installed in the flush silhouette style.
- Available in metal bezel and black plastic bezel.
- Degree of protection depends on that of the control unit.

Types

Package quantity: 1

Shape	Specification	Type No.
 Metal Bezel Round	Bezel: Aluminum Gasket: Nitrile Mounting Bracket: Stainless steel	LA9Z-SM61
 Black Plastic Bezel Round		LA9Z-S61B
 Black Plastic Bezel Square	Bezel: Polyamide Gasket: Nitrile Mounting Bracket: Stainless steel	LA9Z-S71B
 Black Plastic Bezel Rectangular		LA9Z-S81B

Dimensions

• A6 Series

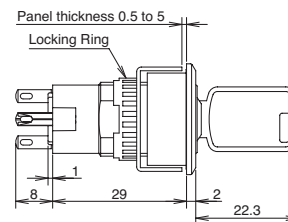

• L6 Series

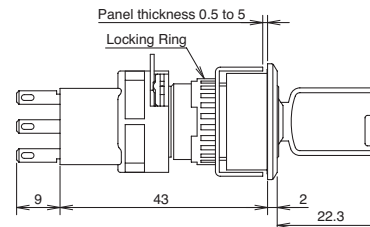

• Mounting Hole Layout

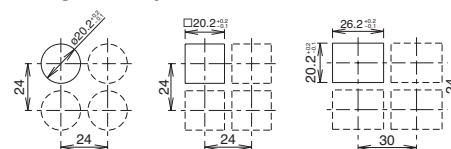

All dimensions in mm.

Specifications and other descriptions in this catalog are subject to change without notice.



IDEC CORPORATION

IDEC CORPORATION (USA)
Tel: +1-408-747-0550 / (800) 262-IDEC (4332)
Fax: +1-408-744-9055 / (800) 635-6246
E-mail: openccontact@iddec.com
IDEC CANADA LIMITED
Tel: +1-905-890-8561, Toll Free: (888) 317-4332
Fax: +1-905-890-8562
E-mail: sales@ca.iddec.com
IDEC AUSTRALIA PTY. LTD.
Tel: +61-3-9763-3244, Toll Free: 1800-68-4332
Fax: +61-3-9763-3255
E-mail: sales@au.iddec.com

7-31, Nishi-Miyahara 1-Chome, Yodogawa-ku, Osaka 532-8550, Japan
Tel: +81-6-6398-2571, Fax: +81-6-6392-9731
E-mail: marketing@iddec.co.jp

IDEC ELECTRONICS LIMITED

Tel: +44-1256-321000, Fax: +44-1256-327755
E-mail: sales@uk.iddec.com

IDEC ELEKTROTECHNIK GmbH

Tel: +49-40-25 30 54 - 0, Fax: +49-40-25 30 54 - 24
E-mail: service@iddec.de

IDEC (SHANGHAI) CORPORATION

Tel: +86-21-5353-1000, Fax: +86-21-5353-1263
E-mail: iddec@cn.iddec.com

IDEC (BEIJING) CORPORATION

Tel: +86-10-6581-6131, Fax: +86-10-6581-5119

IDEC (SHENZHEN) CORPORATION

Tel: +86-755-8356-2977, Fax: +86-755-8356-2944

IDEC IZUMI (H.K.) CO., LTD.

Tel: +852-2803-8889, Fax: +852-2565-0171
E-mail: info@hk.iddec.com

IDEC TAIWAN CORPORATION

Tel: +886-2-2698-3929, Fax: +886-2-2698-3931
E-mail: service@tw.iddec.com

IDEC IZUMI ASIA PTE. LTD.

Tel: +65-6746-1155, Fax: +65-6844-5995
E-mail: info@sg.iddec.com

www.idec.com

Cat. No. EP1275-0 NOVEMBER 2009 PDF