

Switching Power Supplies

PS5R-V



Space-saving DIN-rail switching power supplies.



• See website for details on approvals and standards.

Suitable for global and semiconductor applications

Meets SEMI F47 Sag Immunity

Voltage sag ride-through capabilities for semiconductor process equipment, metering equipment and automatic test equipment. (approved at 208V AC input)

	Part No.	Input Voltage	Output Capacity	Output Voltage / Output Current
	PS5R-VB05	100 to 240V AC (Voltage range: 85 to 264V AC / 100 to 370V DC)	10W	5V/2.0A
	PS5R-VB12		15W	12V/1.3A
	PS5R-VB24			24V/0.65A
	PS5R-VC12		30W	12V/2.5A
	PS5R-VC24			24V/1.3A
	PS5R-VD24		60W	24V/2.5A
	PS5R-VE24		90W	24V/3.75A
	PS5R-VF24		120W	24V/5.0A
	PS5R-VG24		240W	24V/10.0A

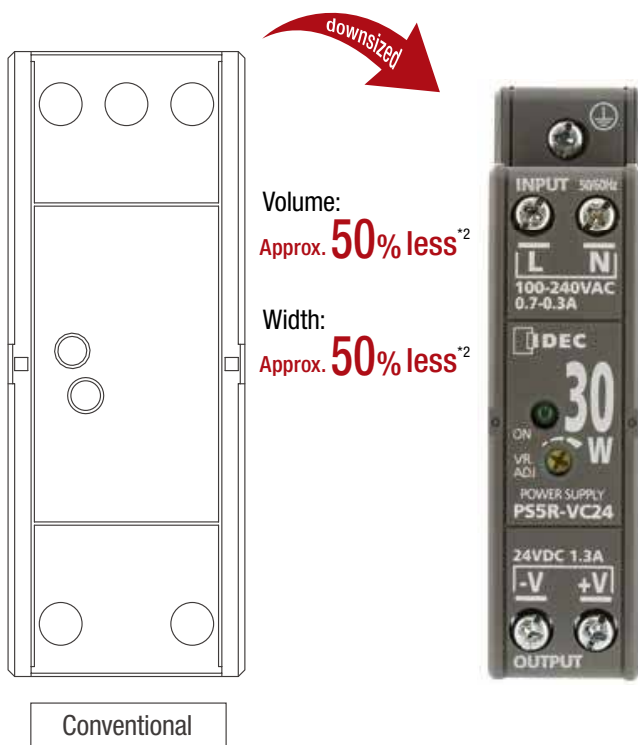

Conventional

Reduced installation space

- Required space between the switching power supplies reduced to half
- Size is reduced to the smaller output capacity (30W/90W/120W) *1

Reduced wiring & flexible installation

- Less wiring required
- Can be installed in six directions

Improved reliability

- Five-year warranty
- Operating temperature -25 to +75°C

*1 Compared with conventional PS5R-S model.
*2 Compared with conventional PS5R-S output capacity 30W model.

- APEM
- Switches & Pilot Lights
- Control Boxes
- Emergency Stop Switches
- Enabling Switches
- Safety Products
- Explosion Proof
- Terminal Blocks
- Relays & Sockets
- Circuit Protectors
- Power Supplies**
- LED Illumination
- Controllers
- Operator Interfaces
- Sensors
- AUTO-ID

Reduces installation space inside the panel

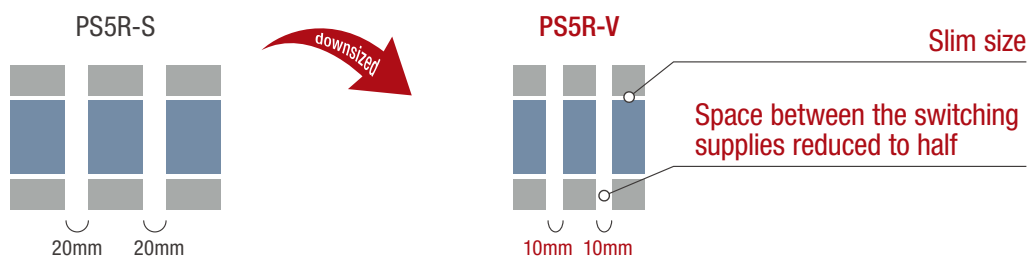

PS5R-S

PS5R-V

Slim size

Space between the switching supplies reduced to half

PS5R-V

PS6R

Reduced wiring & flexible installation

Reduced wiring



Spring-up terminals accepts wiring of ring terminals. No need to worry about losing screws .

Six mounting directions

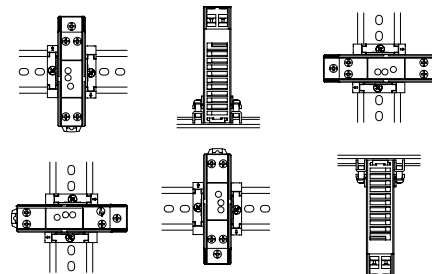

Download catalogs and CAD from <http://asia.idec.com/downloads>

PS5R-V Switching Power Supplies

Space-saving DIN-rail switching power supplies

PS5R-V

Package Quantity: 1

Shape	10W/15W	30W	60W/90W	120W	240W
Output Capacity	10W	15W	30W	60W	90W
Part No.	PS5R-VB05	PS5R-VB12	PS5R-VB24	PS5R-VC12	PS5R-VC24
Input Voltage	100 to 240V AC (Voltage range: 85 to 264V AC / 100 to 370V DC)				
Output Voltage	5V	12V	24V	12V	24V
Output Current	2.0 A	1.3 A	0.65A	2.5 A	1.3 A
				24V	2.5 A
				24V	2.5 A
				24V	3.75A
				24V	5.0 A
				24V	10.0 A

DIN Rail (35mm-wide)

Length	Part No.	Material	Weight	Package Quantity	Remarks
1,000mm	BAA1000PN10	Aluminum	200g	10	See H-071 for DIN rail products.
	BAP1000PN10	Steel	320g	10	

End Clip

Part No.	Package Quantity	Remarks
BNL6PN10	10	Applicable rail: BAA,BAP Weight: approx.15g

Panel Mounting Bracket *1

Applicable Switching Power Supply	Ordering No.	Remarks
PS5R-VB	PS9Z-5R1B	—
PS5R-VC	PS9Z-5R2B	For side mounting
PS5R-VD	PS9Z-5R1C	—
PS5R-VE	PS9Z-5R1E	—
PS5R-VF	PS9Z-6R1F	—
PS5R-VG	PS9Z-6R2F	For side mounting

*1: Used for direct panel mounting.

Part No. Development

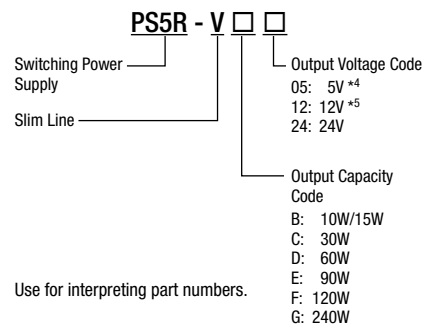

*4: PS5R-VB only
*5: PS5R-VB/VC only

PS5R-V Switching Power Supplies

Power Supplies

Specifications

Part No.		(10W/15W) PS5R-VB05 PS5R-VB12 PS5R-VB24	(30W) PS5R-VC12 PS5R-VC24	(60W) PS5R-VD24	(90W) PS5R-VE24	(120W) PS5R-VF24	(240W) PS5R-VG24	
Input	Rated Input Voltage (Single-phase two-wire)(*)1, *2	100 to 240V AC (Voltage range: 85 to 264V AC/100 to 370V DC) (Load ≤ 80% at 100-105V DC)						
	Frequency	50/60 Hz						
	Input Current (Typ.)	100V AC	5V: 0.25A 12V, 24V: 0.35A	0.7A	1.3A	1.1A	1.4A	2.7A
		230V AC	5V: 0.14A 12V, 24V: 0.19A	0.3A	0.8A	0.6A	0.7A	1.2A
	Inrush Current (Typ.)	100V AC	18A (Ta = 25°C, cold start)					14A max. (Ta = 25°C, cold start)
		230V AC	45A (Ta = 25°C, cold start)					30A max. (Ta = 25°C, cold start)
	Leakage Current	120V AC	0.5 mA max.					
		230V AC	1.0 mA max.					
	Efficiency (Typ.) (at rated output) (*3)	100V AC	5V: 77%, 12V: 82%, 24V: 84%	12V: 83%, 24V: 85%	86%	88%		89%
		230V AC	5V: 73%, 12V: 80%, 24V: 81%	12V: 85%, 24V: 87%	86%	89%		90%
Power Factor (Typ.)	100V AC	—		—	0.99			
	230V AC	—		—	0.86		0.92	
Output	Rated Voltage/Current	5V/2.0A(*4), 12V/1.3A, 24V/0.65A	12V/2.5A, 24V/1.3A	24V/2.5A	24V/3.75A	24V/5A	24V/10A	
	Adjustable Voltage Range	±10%				±5%	±10%	
	Output Holding Time (Typ.) (at rated output)	100V AC	5V: 53ms 12V: 34ms 24V: 36ms	12V: 13ms 24V: 15ms	13ms	20ms	30ms	30ms
		230V AC	5V: 330ms 12V: 215ms 24V: 230ms	12V: 110ms 24V: 110ms	105ms	30ms	33ms	40ms
	Start Time (at rated input and output)	500 ms max.		600 ms max.	800 ms max.		700 ms max.	800 ms max.
	Rise Time (at rated input and output)	5V, 12V: 200ms max. 24V: 250ms max.		200ms max.				
	Regulation	Input Fluctuation	0.4% max.					
		Load Fluctuation	5V: 2.5% max. 12V, 24V: 1.0% max.	1.0% max.				
	Temperature Change	0.05%/°C max. (-10 to +65°C)		12V: 0.05%/°C max. (-10 to +50°C) 24V: 0.05%/°C max. (-10 to +55°C)	0.05%/°C max. (-10 to +55°C)		0.05%/°C max. (-25 to +55°C)	
		Ripple (including noise)	5V: 8% p-p max. (-25 to -10°C) 12V: 6% p-p max. (-25 to -10°C) 24V: 4% p-p max. (-25 to -10°C)		12V: 6% p-p max. (-25 to -10°C) 24V: 4% p-p max. (-25 to -10°C)	4% p-p max. (-25 to -10°C)		4% p-p max. (-25 to -10°C)
5V: 5% p-p max. (-10 to +0°C) 12V: 2.5% p-p max. (-10 to +0°C) 24V: 1.5% p-p max. (-10 to +0°C)			12V: 2.5% p-p max. (-10 to +0°C) 24V: 1.5% p-p max. (-10 to +0°C)	1.5% p-p max. (-10 to +0°C)		1.5% p-p max. (-10 to +0°C)		
5V: 2.5% p-p max. (0 to +65°C) 12V: 1.5% p-p max. (0 to +65°C) 24V: 1% p-p max. (0 to +65°C)		12V: 1.5% p-p max. (0 to +50°C) 24V: 1% p-p max. (0 to +55°C)	1% p-p max. (0 to +55°C)		1% p-p max. (0 to +55°C)			
Supplementary Functions	Overcurrent Protection	105% min. (auto reset)			101% min. (auto reset)	105% min. (auto reset)		
	Operation Indicator	LED (green)						
Dielectric Strength		Between input and output terminals: 3,000V AC, 1 minute Between input and ground terminals: 2,000V AC, 1 minute Between output and ground terminal: 500V AC, 1 minute						
Insulation Resistance		Between input and output terminals: 100MΩ min. (500V DC megger), Between input and ground terminal: 100MΩ min. (500V DC megger)						
Operating Temperature (*2)		-25 to +75°C (no freezing)	-25 to +70°C (no freezing)		-25 to +65°C (no freezing)			
Operating Humidity		20 to 90% RH (no condensation)						
Storage Temperature		-25 to +75°C (no freezing)						
Storage Humidity		20 to 90% RH (no condensation)						
Vibration Resistance		10 to 55 Hz, amplitude 0.375mm, 2 hours each in 3 axes (when used with part no. BNL6 mounting clips)			10 to 55 Hz, amplitude 0.33mm, 2 hours each in 3 axes (when used with part no. BNL6 mounting clips) 10 to 55 Hz, amplitude 0.375mm, 2 hours each in 3 axes (when used with part no. BNL8 mounting clips)		10 to 55 Hz, amplitude 0.21mm, 2 hours each in 3 axes (when used with part no. BNL6 mounting clips) 10 to 55 Hz, amplitude 0.375mm, 2 hours each in 3 axes (when used with part no. BNL6 mounting clips)	
Shock Resistance		300 m/s ² , 3 times each in 6 directions						
EMC	EMI	EN61204-3 (Class B)						
	EMS	EN61204-3 (industrial)						
Safety Standards		UL508 (Listing), UL1310 Class 2, ANSI/ISA-12.12.01, CSA C22.2 No. 107.1, 213, 223 EN60950-1, EN50178, SELV (UL60950-1, EN60950-1)				UL508 (Listing), ANSI/ISA-12.12.01, CSA C22.2 No. 107.1, 213, EN60950-1, EN50178, SELV (EN60950-1)		
Other Standard		SEMI F47 (at 208V AC input only)						
Degree of Protection		IP20 (EN60529)						
Dimensions (mm)		90H × 22.5W × 95D		95H × 36W × 108D		115H × 46W × 121D	125H × 60W × 125D	
Weight (approx.)		140g	150g	260g	310g	470g	960g	
Terminal Screw		M3.5						

At normal temperature and humidity unless otherwise specified.

*1: DC input voltage is not subject to safety standards. When using on DC input, connect a fuse to the input terminal for DC input protection.

*2: See the output derating curves on J-008. *3: Under stable state.

*4: PS5R-VB05 (5V DC/2.0A) is 10W (Up to 3.0A at Ta = 0 to 40°C. Not subject to safety standards at 2.0A and over.)

Reference Value

Expected Life (*5)	8 years minimum (at the rated input, 50% load, operating temperature +40°C, standard mounting direction)
--------------------	--

*5: Calculation of the expected life is based on the actual life of the aluminum electrolytic capacitor. The expected life depends on operating conditions.



Download catalogs and CAD from <http://asia.idec.com/downloads>

J-006

PS5R-V Switching Power Supplies

Block Diagrams

PS5R-VB

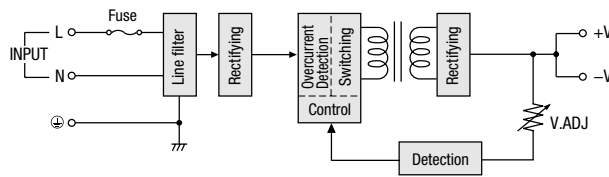

PS5R-VC/PS5R-VD

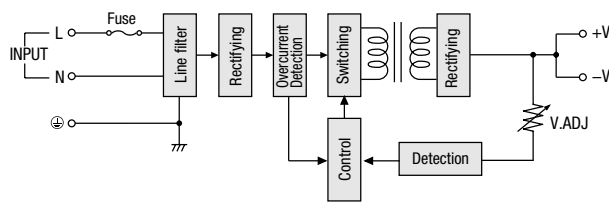

PS5R-VE24

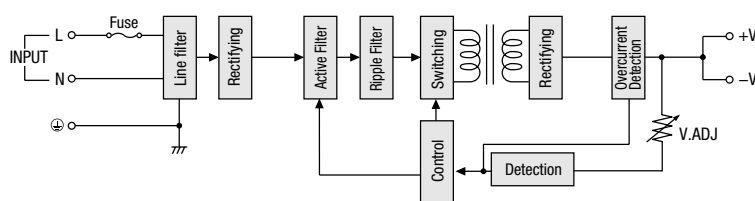

PS5R-VF24

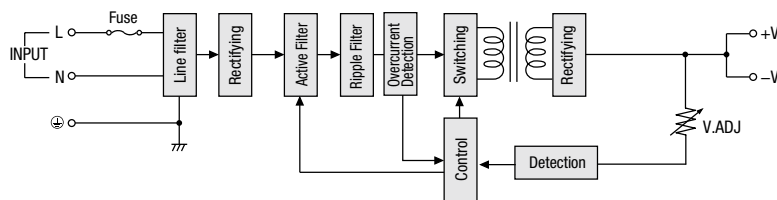

PS5R-VG24

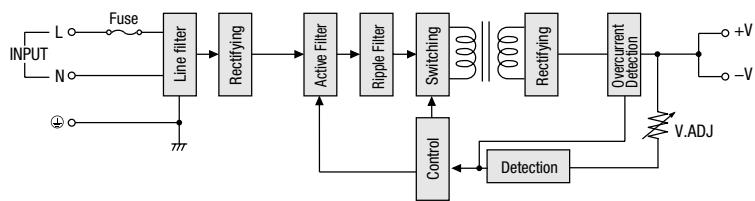

- APEM
- Switches & Pilot Lights
- Control Boxes
- Emergency Stop Switches
- Enabling Switches
- Safety Products
- Explosion Proof
- Terminal Blocks
- Relays & Sockets
- Circuit Protectors
- Power Supplies**
- LED Illumination
- Controllers
- Operator Interfaces
- Sensors
- AUTO-ID

- PS5R-V**
- PS6R

PS5R-V Switching Power Supplies

Power Supplies

Characteristics

Operating Temperature vs. Output Current (Derating Curves)

Conditions: Natural air cooling (Operating temperature is the temperature around the switching power supply.)

PS5R-VB05, -VB12, -VB24

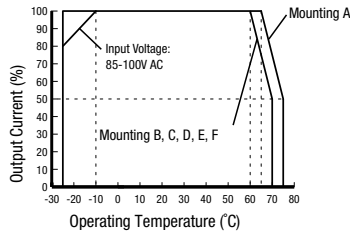

PS5R-VC12

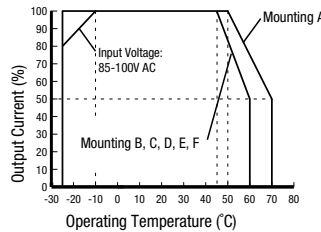

PS5R-VC24

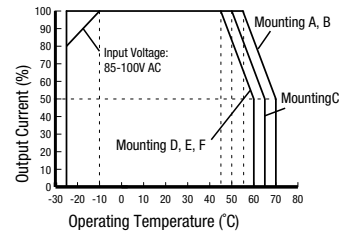

PS5R-VD24

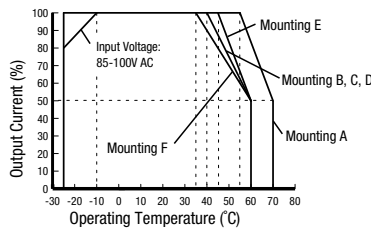

PS5R-VE24

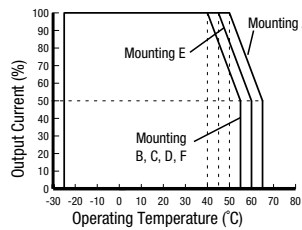

PS5R-VF24

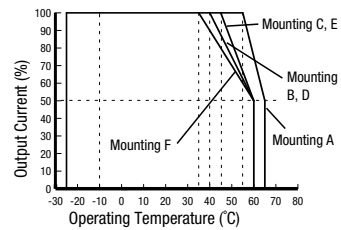

PS5R-VG24

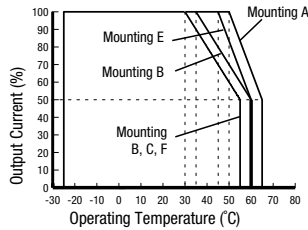

Operating Temperature Approved by Safety Standards (°C)

Part No.	UL508, CSA C22.2 No.107.1, ANSI/ISA12.12.01, EN60950-1, EN50178					
	Mounting A	Mounting B	Mounting C	Mounting D	Mounting E	Mounting F
PS5R-VB05, -VB12, -VB24	65	60	60	60	60	60
PS5R-VC12	50	45	45	45	45	45
PS5R-VC24	55	55	50	45	45	45
PS5R-VD24	55	40	40	40	45	35
PS5R-VE24	50	40	40	40	45	40
PS5R-VF24	55	40	45	40	45	35
PS5R-VG24	50	35	30	30	45	30

Mounting Style

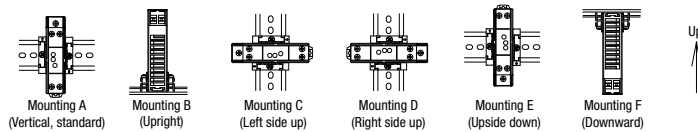

Output Current vs. Input Voltage (derating curves)

PS5R-VG24

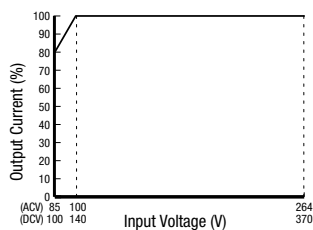

Download catalogs and CAD from <http://asia.idec.com/downloads>

J-008

- APEM
- Switches & Pilot Lights
- Control Boxes
- Emergency Stop Switches
- Enabling Switches
- Safety Products
- Explosion Proof
- Terminal Blocks
- Relays & Sockets
- Circuit Protectors
- Power Supplies**
- LED Illumination
- Controllers
- Operator Interfaces
- Sensors
- AUTO-ID

PS5R-V

PS6R

PS5R-V Switching Power Supplies

Overcurrent Protection Characteristics

PS5R-VB/VC/VD/VE

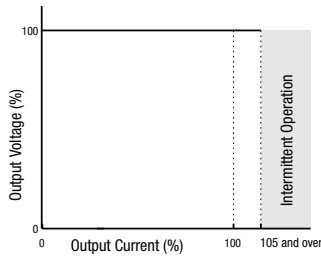

PS5R-VE24

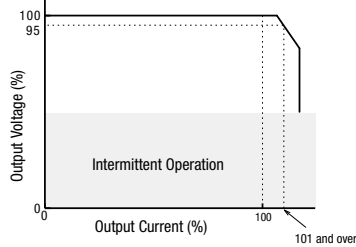

PS5R-VG24

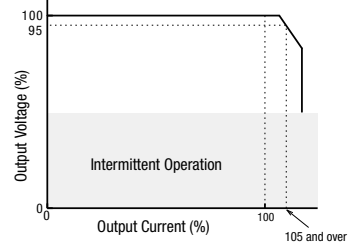

Parts Description

PS5R-VB/VC

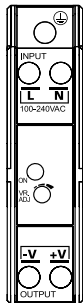

PS5R-VD/VE/VE

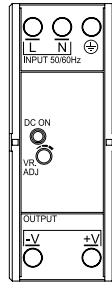

PS5R-VG

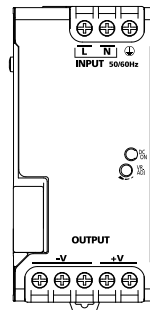

Marking	Name	Description
L, N	AC Input Terminal	Voltage range: 85 to 264V AC/100 to 370V DC
⊕	Ground Terminal	Be sure to connect this terminal to a proper ground.
+V, -V	DC Output Terminals	+V: Positive output terminal -V: Negative output terminal
VR.ADJ	Output Voltage Adjustment	Turning clockwise increases the output voltage. Turning counterclockwise decreases the output voltage.
DC ON	Operation Indicator (green)	Lights when the output voltage is on.

PS5R-V Switching Power Supplies

Power Supplies

Dimensions

PS5R-VB/VC

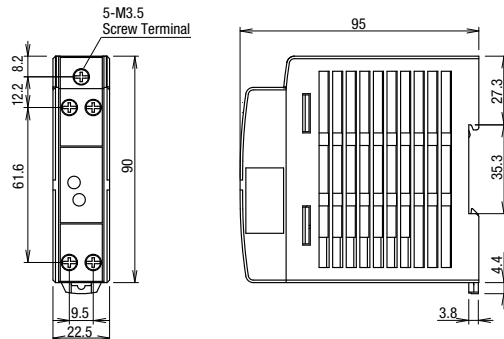

PS5R-VD/VE

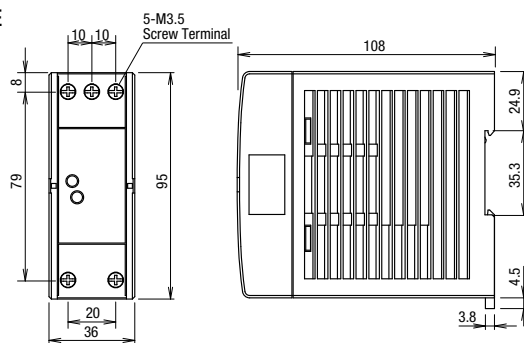

PS5R-VF

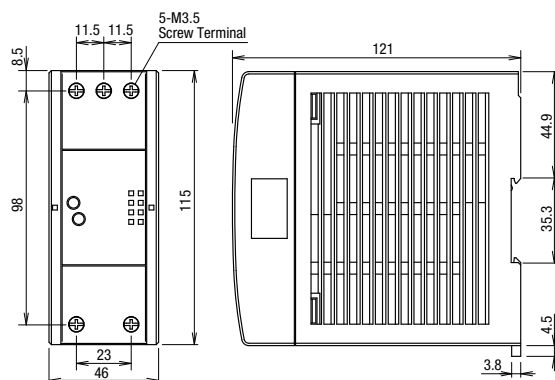

PS5R-VG

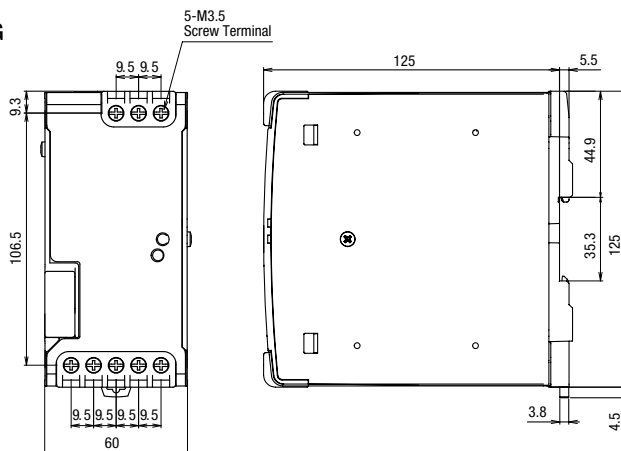

All dimensions in mm.
Tolerance: ± 1 mm

- APEM
- Switches & Pilot Lights
- Control Boxes
- Emergency Stop Switches
- Enabling Switches
- Safety Products
- Explosion Proof
- Terminal Blocks
- Relays & Sockets
- Circuit Protectors
- Power Supplies
- LED Illumination
- Controllers
- Operator Interfaces
- Sensors
- AUTO-ID

PS5R-V

PS6R

Download catalogs and CAD from <http://asia.idec.com/downloads>

J-010

PS5R-V Switching Power Supplies

Dimensions

Panel Mounting Bracket

PS9Z-5R1B

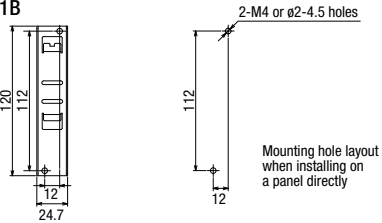

When installed on switching power supply

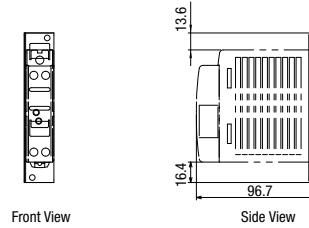

PS9Z-5R2B Side-mount

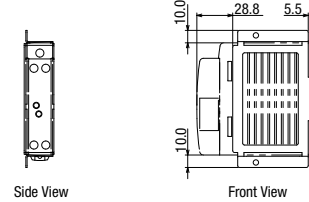
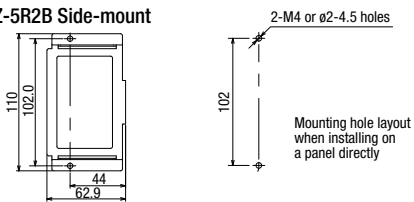

PS9Z-5R1C

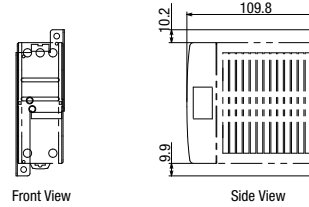
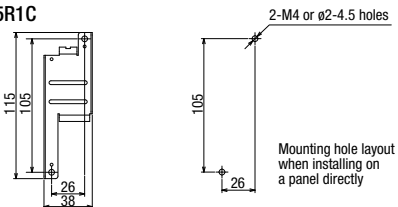

PS9Z-5R1E

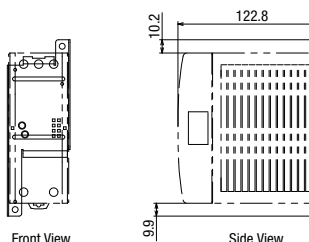
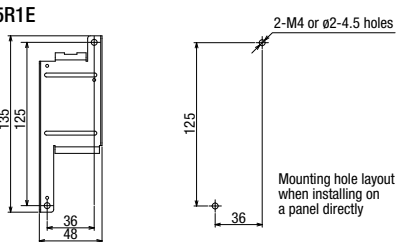

PS9Z-6R1F

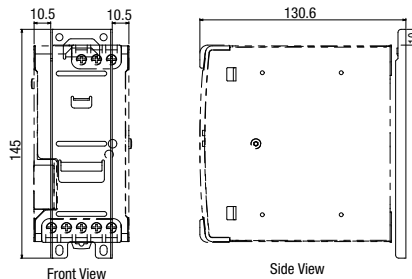
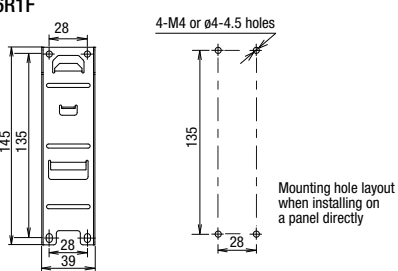

PS9Z-6R2F Side-mount

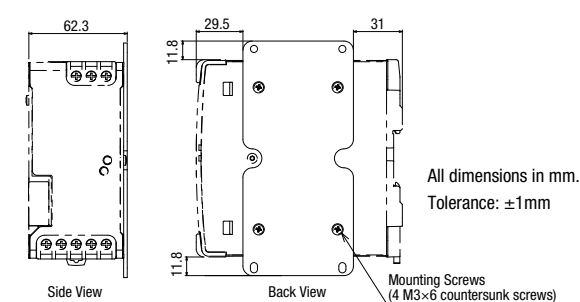
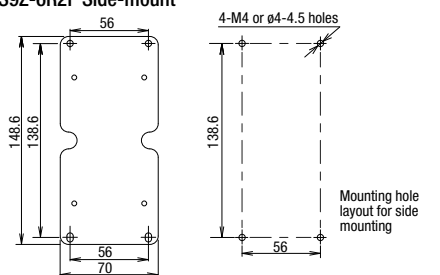

⚠ Safety Precautions

Mount the PS5R-V in an enclosure. Do not use the PS5R-V alone as an Electric Facilities for General Use.
Use the PS5R-V for electric facilities for business use only.

- Do not use switching power supplies with electric equipment whose malfunction or inadvertent operation may damage the human body or life directly.
- Make sure that the input voltage and output current do not exceed the ratings. If the input voltage and output current exceed the ratings, electric shock, fire, or malfunction may occur.
- Do not touch the terminals of the switching power supply while input voltage is applied, otherwise electric shock may occur.
- Provide the final product with protection against malfunction or damage that may be caused by malfunction of the switching power supply.

- Operating temperatures should not exceed the ratings. Be sure to note the derating characteristics. If the operating temperature exceeds the ratings, electric shock, fire, or malfunction may occur.
- Blown fuses indicate that the internal circuits are damaged. Contact IDEC for repair. Do not just replace the fuse and reoperate, otherwise electric shock, fire, or malfunction may occur.
- Do not use the switching power supplies to charge rechargeable batteries.
- Do not overload or short-circuit the switching power supply for a long period of time, otherwise the internal elements may be damaged.
- Do not disassemble, repair, or modify the power supplies, otherwise the high voltage internal part may cause electric shock, fire, or malfunction.
- The fuse inside the PS5R-V switching power supply is for AC input. Use a DC fuse for DC input.

Operating Instructions

Notes for installation

- Do not close the top and bottom openings of the PS5R-V to allow for heat radiation by convection.
- Maintain a minimum of 10 mm clearance around the PS5R-V, except for the top and bottom openings.
- When mounting multiple PS5R-V switching power supplies side by side, maintain a minimum of 10 mm clearance. Observe the derating curves in consideration of the ambient temperature.

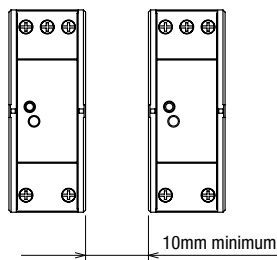

- When the derating voltage may exceed the recommended value, provide forced air-cooling.
- Make sure to wire the ground terminal correctly.
- For wiring, use wires of heat resistance of 60°C or higher (PS5R-VB: 80°C or higher). Use copper wire of the following sizes, according to the rated current.

Terminal	Wire Size (allowable current)	Wire Type
Input	AWG18 to 14	Copper Solid/Stranded
Output	AWG18 to 14 (AWG18: 7A, AWG16: 10A, AWG14: 15A)	

Cross-sectional area
AWG18: 0.82mm², AWG16: 1.31mm², AWG14: 2.0mm²

Note: Wires of the above size must be used to comply with UL508, CSA C22.2 No. 107.1.

Applicable crimp terminal (reference)

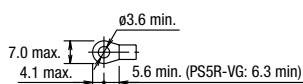

- Recommended tightening torque of the input and output terminals is 1.0 to 1.3 N·m (0.8 N·m for UL).

Mounting on DIN Rails

1. Use a 35mm-wide DIN rail.
2. Fasten the DIN rail to a mounting plate using screws.
3. Place the PS5R-V on the DIN rail as shown with input terminal side up (①), and press the PS5R-V towards the DIN rail (②). Make sure that the PS5R-V is installed firmly.
4. Use BNL6 mounting clips for fastening the PS5R-V on the DIN rail. Use of BNL8 mounting clips is recommended when excessive vibration or shock is anticipated. Do not use the PS5R-V when it is subject to vibration constantly.

Removal

- Insert a flat screwdriver into the slot in the clamp, and pull out the clamp until it clicks (③). The lock mechanism is released and the PS5R-V can be removed (④). When mounting the PS5R-V again, push in the latch first.

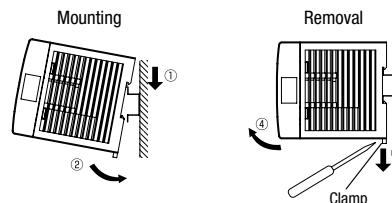

- APEM
- Switches & Pilot Lights
- Control Boxes
- Emergency Stop Switches
- Enabling Switches
- Safety Products
- Explosion Proof
- Terminal Blocks
- Relays & Sockets
- Circuit Protectors
- Power Supplies**
- LED Illumination
- Controllers
- Operator Interfaces
- Sensors
- AUTO-ID

- PS5R-V**
- PS6R

Download catalogs and CAD from <http://asia.idec.com/downloads>

PS5R-V Switching Power Supplies

Operating Instructions

Installing the Panel Mounting Bracket

<Installing PS9Z-5R1□ Panel Mounting Bracket>

Panel Mounting Bracket (PS9Z-5R1□)

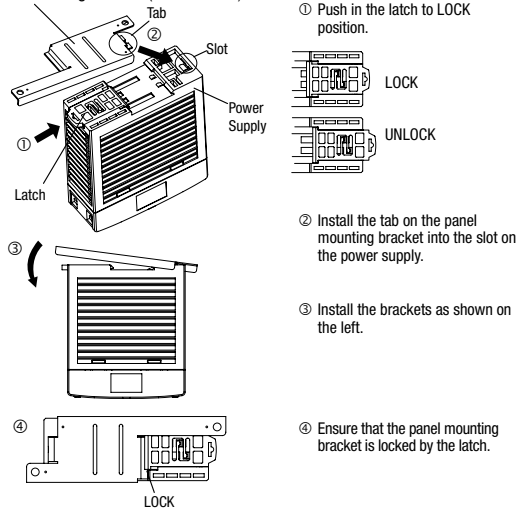

<Installing PS9Z-5R2B Panel Mounting Bracket>

Panel Mounting Bracket (PS9Z-5R2B)

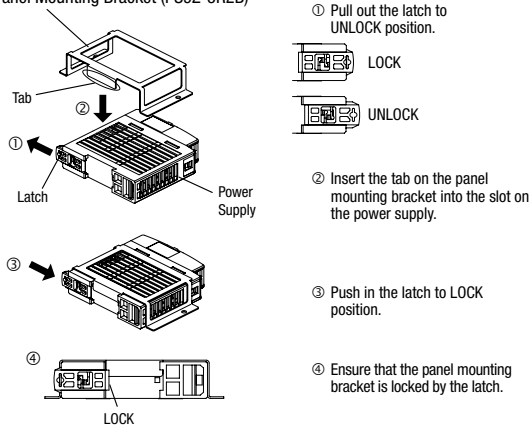

Installing PS9Z-6R2F Side-mount Panel Mounting Bracket

Install the bracket on the switching power supply using four M3 × 6 countersunk screws supplied with the bracket.

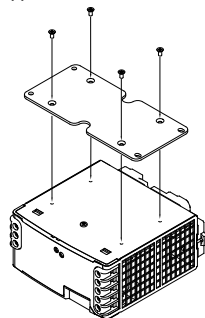

Adjustment of Output Voltage

The output voltage can be adjusted within $\pm 10\%$ of the rated output voltage (PS5R-VE: $\pm 5\%$) by using the VR.ADJ control on the front. Turning the VR.ADJ clockwise increases the output voltage. Turning the VR.ADJ counterclockwise decreases the output voltage.

Overcurrent Protection

The output voltage drops automatically when an overcurrent flows due to an overload or short circuit. Normal voltage is automatically restored when the load returns to normal conditions.

Insulation/Dielectric Test

When performing an insulation/dielectric test, short-circuit the input (between L and N) and output (between +V and -V). Do not apply or interrupt the voltage quickly, otherwise surge voltages may be generated and the PS5R-V may be damaged.

Notes for Operation

- Output interruption may indicate blown fuses. Contact IDEC.
- The PS5R-V switching power supply contains an internal fuse for AC input. When using with DC input, install an external fuse for DC input. To avoid blown fuses, select a fuse in consideration of the rated current of the internal fuse.

Rated Current of Internal Fuses

Part No.	Internal Fuse Rated Current
PS5R-VB/VC	2A
PS5R-VD/VE/VE/F	4A
PS5R-VG	6.3A

- Avoid overload and short-circuit for a long period of time, otherwise the internal elements may be damaged.
- DC input operation is not subject to safety standards.

Rust and Scratches on Metal parts

Hot-dip galvanized steel and bonderized steel are used for the PS5R-V. Rust on the edge and scratches on the surfaces may be developed depending on the storage condition, but the performance of the PS5R-V is not affected.

Noise

Small acoustic noise inside the PS5R-V may be heard depending on the input voltage and load, but the performance of the PS5R-V is not affected.

Operating Instructions

Series Operation

The following series operation is allowed. In (b) series operation, connect Schottky barrier diodes. Choose (a) series operation when using the PS5R-V as positive and negative output power supply. Insert a Schottky barrier diode for loads such as operational amplifier where outputs of two power supplies may be connected in series (Load 3). Select a Schottky diode in consideration of the rated current.

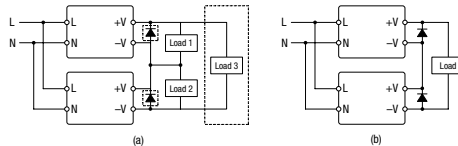

Parallel Operation

Parallel operation is not possible to increase the output capacity, because the internal elements and load may be damaged.

Backup Operation

Backup operation is a connection method of two switching power supplies in parallel for emergency. Normally one switching power supply has a sufficient output. If one switching power supply fails, another one operates to continue the output. Make sure that the sum of power consumption by load and diode is not greater than the rated wattage (rated voltage × rated current) of one switching power supply.

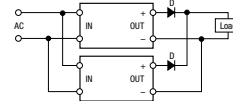

Select a diode in consideration of:

Diode's current must be more than double the PS5R-V's output current. Take heat dissipation into consideration.

Warranty

Warranty

IDEC warrants the PS5R-V switching power supplies for a period of five years from the date of shipment.

Scope

IDEC agrees to repair or replace the PS5R-V switching power supply if the product has been operated under the following conditions. The maximum value of output capacity is within the range shown in "Operating Temperature vs. Output Current" on **J-008**.

1. Average operating temperature (ambient temperature of switching power supply) is 40°C maximum.
2. The load is 80% maximum.
3. Input voltage is the rated input voltage.
4. Standard mounting style

IDEC shall not be liable for other damages including consequential, contingent or incidental damages. Warranty does not apply if the PS5R-V switching power supply was subject to:

1. Inappropriate handling, or operation beyond the specifications.
2. Modification or repair by other than IDEC.
3. Failure caused by other than the PS5R-V switching power supply.
4. Failure caused by natural disasters.



Download catalogs and CAD from <http://asia.idec.com/downloads>

J-014

APEM

Switches & Pilot Lights

Control Boxes

Emergency Stop Switches

Enabling Switches

Safety Products

Explosion Proof

Terminal Blocks

Relays & Sockets

Circuit Protectors

Power Supplies

LED Illumination

Controllers

Operator Interfaces

Sensors

AUTO-ID

PS5R-V

PS6R