

Emergency Stop Switches

X6 Series



Excellent safety and design.
The shortest depth behind the
panel in its class.



• See website for details on approvals and standards.

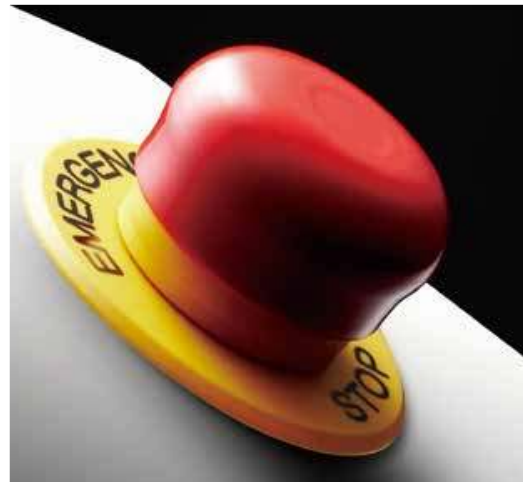

Excellent safety

Third-generation

Reverse Energy Structure

IDEC's unique Reverse Energy Structure, achieved as a result of in-depth failure analysis of emergency stop switches, has resulted in this innovative emergency stop switch. X6 series emergency stop switches provide the highest level of safety, because the unibody design eliminates the possibility of the contact blocks falling off the switch.

Unparalleled design

The smooth button is ideal for applications that require utmost cleanliness, such as food processing machines or semiconductor manufacturing equipment. Also suitable for applications requiring a sleek design of emergency stop switches, such as medical equipment.



Only 19.5 mm depth behind the panel

The short depth behind the panel reduces the required mounting space.
Depth: 30% reduction
Volume: 70% reduction
(Compared with conventional emergency stop switches)
Thus equipment and control panels can be made much smaller.



*1: Solder terminal.
Solder/tab terminal: 23.9mm

Prevents dust build-up

The smooth and ridge-less button surface prevents dust built-up, and is also easy to clean.

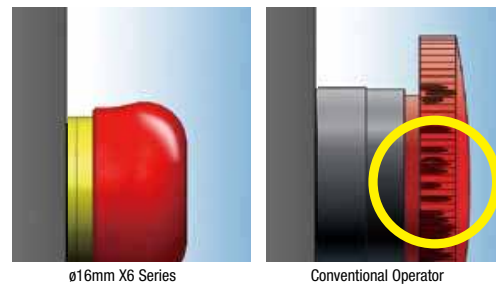

Two ways to reset, two button sizes, two wiring methods.

The X6 emergency stop switch can be reset either by pulling or turning. The button is available in ø30 mm and ø40 mm sizes. In addition to a red button, a yellow button is also available as a stop switch. Solder terminals and solder/tab terminals are available.

Two ways to reset



Pull to reset

Turn to reset

Two connection methods



Solder Terminal

Solder/Tab Terminal #110

- APEM
- Switches & Pilot Lights
- Control Boxes
- Emergency Stop Switches
- Enabling Switches
- Safety Products
- Explosion Proof
- Terminal Blocks
- Relays & Sockets
- Circuit Protectors
- Power Supplies
- LED Illumination
- Controllers
- Operator Interfaces
- Sensors
- AUTO-ID

- X6
- XA
- XW
- XN
- SEMI

Download catalogs and CAD from <http://eu.idec.com/downloads>

D-008

ø16 X6 Series Emergency Stop Switches (Unibody)

Third-generation emergency stop switch with Reverse Energy Structure Smallest in its class

- Two button sizes—ø30mm and ø40mm
- Two ways of resetting —pulling and turning.
- Safety lock mechanism (IEC 60947-5-5; 6.2)
- Direct opening action (IEC 60947-5-5; 5.2, IEC 60947-5-1, Annex K)
- Degree of protection: IP65 (IEC60529)



APEM

Switches & Pilot Lights

Control Boxes

Emergency Stop Switches

Enabling Switches

Safety Products

Explosion Proof

Terminal Blocks

Relays & Sockets

Circuit Protectors

Power Supplies

LED Illumination

Controllers

Operator Interfaces

Sensors

AUTO-ID

X6

XA

XW

XN

SEMI

Standards and Specifications

Contact Ratings

Rated Insulation Voltage (Ui)		250V				
Rated Thermal Current (Ith)		5A				
Rated Operating Voltage (Ue)		30V	125V	250V		
Rated Operating Current (Note)	Main Contacts	AC 50/60 Hz	Resistive Load (AC-12)	–	5A	3A
			Inductive Load (AC-15)	–	1.5A	0.75A
	DC	Resistive Load (DC-12)	2A	0.4A	0.2A	
		Inductive Load (DC-13)	1A	0.22A	0.1A	

- Minimum applicable load: 5V AC/DC, 1 mA (reference value) (May vary depending on the operating conditions and load)
- Operational current represents the classification by making and breaking currents (IEC 60947-5-1).

Note:
TUV/CCC rating: AC-15 0.75A/250V, DC-13 1A/30V
UL rating: Standard Duty AC 0.75A/250V
Standard Duty DC 1A/30V

Specifications

Applicable Standards	IEC 60947-5-1, EN 60947-5-1 IEC 60947-5-5 (Note), EN 60947-5-5 (Note) JIS C8201-5-1, JIS C8201-5-5, UL508 CSA C22.2 No.14, GB14048.5
Operating Temperature	–25 to +60°C (no freezing)
Operating Humidity	45 to 85% RH (no condensation)
Storage Temperature	–45 to +80°C (no freezing)
Operating Force	Push to lock: 10.5N Pull to reset: 8.8N Turn to reset: 0.17 N·m
Minimum Force Required for Direct Opening Action	40N
Minimum Operator Stroke Required for Direct Opening Action	4.5 mm
Maximum Operator Stroke	4.5 mm
Contact Resistance	50 mΩ maximum (initial value)
Insulation Resistance	100 MΩ minimum (500V DC megger)
Overvoltage Category	II
Impulse Withstand Voltage	2.5 kV
Pollution Degree	3
Operation Frequency	900 operations/hour
Shock Resistance	Operation extremes: 150 m/s ² Damage limits: 1000 m/s ²
Vibration Resistance	Operation extremes: 10 to 500 Hz amplitude 0.35 mm, acceleration 50 m/s ² Damage limits: 10 to 500 Hz, amplitude 0.35 mm, acceleration 50 m/s ²
Mechanical Life	100,000 operations minimum
Electrical Life	100,000 operations minimum
Degree of Protection	IP65 (IEC 60529)
Short-circuit Protection	250V/10A fuse (Type aM IEC 60269-1/IEC 60269-2)
Conditional Short-circuit Current	1000A
Terminal Style	Solder terminal, Solder/tab terminal #110
Recommended Tightening Torque for Locking Ring	0.88 N·m
Applicable Wire Size	1.25 mm ² maximum (AWG16 maximum)
Terminal Soldering Condition	310 to 350°C, within 3 seconds
Weight (approx.)	ø30mm button: 13g ø40mm button: 16g

ø16 X6 Series Emergency Stop Switches (Unibody)



Emergency Stop Switches

Pushlock Pull/Turn Reset Switch (Solder Terminal)

Unmarked

Pushlock Pull/Turn Reset Switch

Package quantity: 1

Shape	Main Contact (NC)	Part No.	
		Solder Terminal	Solder/tab Terminal #110
 ø30mm Mushroom	1NC	AB6E-3BV01PRH	AB6E-3BV01PTRH
	2NC	AB6E-3BV02PRH	AB6E-3BV02PTRH
 ø40mm Mushroom	1NC	AB6E-4BV01PRH	AB6E-4BV01PTRH
	2NC	AB6E-4BV02PRH	AB6E-4BV02PTRH

• Pushlock pull/turn reset switches are locked when pressed, and reset when pulled or turned clockwise.

Arrow Marked

Pushlock Pull/Turn Reset Switch

Package quantity: 1

Shape	Main Contact (NC)	Part No.	
		Solder Terminal	Solder/tab Terminal #110
 ø30mm Mushroom	1NC	AB6E-3BV01PRM	AB6E-3BV01PTRM
	2NC	AB6E-3BV02PRM	AB6E-3BV02PTRM
 ø40mm Mushroom	1NC	AB6E-4BV01PRM	AB6E-4BV01PTRM
	2NC	AB6E-4BV02PRM	AB6E-4BV02PTRM

• Pushlock pull/turn reset switches are locked when pressed, and reset when pulled or turned clockwise.

- APEM
- Switches & Pilot Lights
- Control Boxes
- Emergency Stop Switches
- Enabling Switches
- Safety Products
- Explosion Proof
- Terminal Blocks
- Relays & Sockets
- Circuit Protectors
- Power Supplies
- LED Illumination
- Controllers
- Operator Interfaces
- Sensors
- AUTO-ID
- X6
- XA
- XW
- XN
- SEMI

 Download catalogs and CAD from <http://eu.idec.com/downloads>

D-010

ø16 X6 Series Emergency Stop Switches (Unibody)

Dimensions

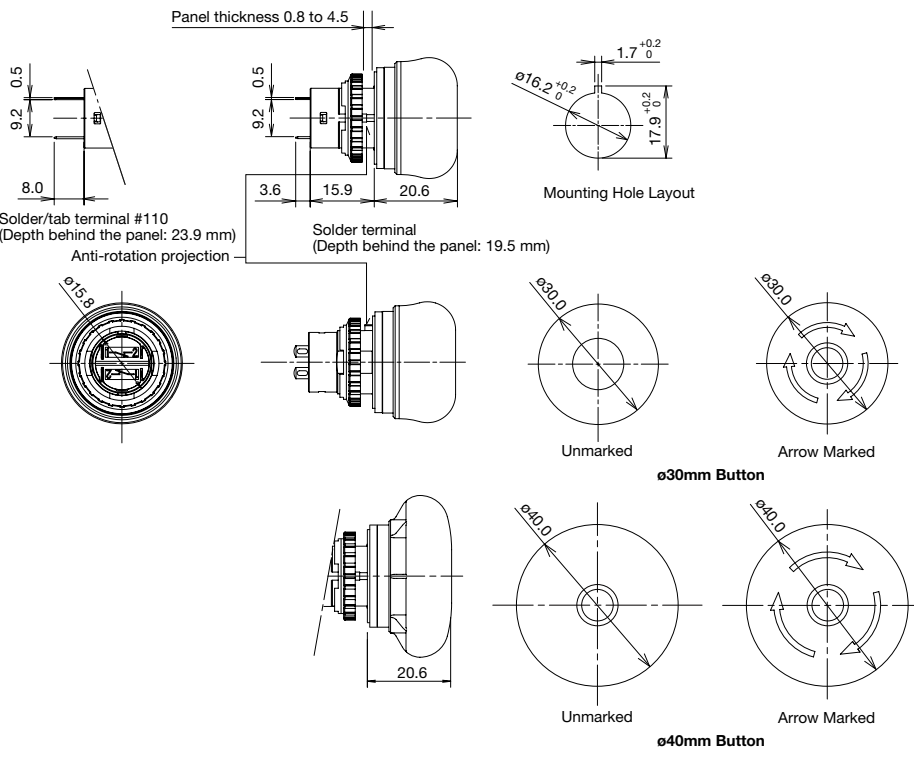

All dimensions in mm.

Mounting Hole Layout

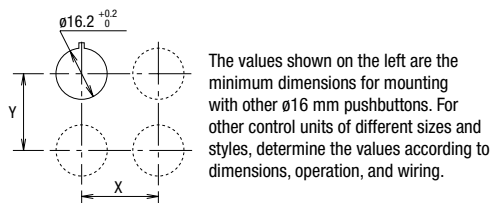

	X	Y
ø30 mm Button	40 mm min.	40mm min.
ø40 mm Button	50 mm min.	50mm min.

• See **D-047** for accessories and replacement parts.

Terminal Arrangement (Bottom View)

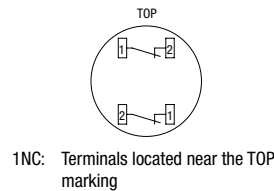

ø16 X6 Series Emergency Stop Switches (Unibody)

Emergency Stop Switches

⚠ Safety Precautions

- Turn off power to the X6 series units before installation, removal, wiring, maintenance, and inspection. Failure to turn power off may cause electrical shocks or fire hazard.
- For wiring, use wires of proper size to meet the voltage and current requirements and solder properly. Improper soldering may cause overheating and create fire hazards.

Instructions

Panel Mounting

Remove the locking ring from the operator and check that the rubber gasket is in place. Insert the operator from panel front into the panel hole. Face the side with the projection upward, and tighten the locking ring using the locking ring wrench MT-001.

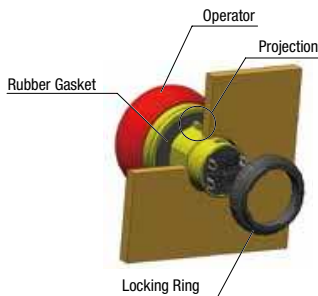

Notes for Panel Mounting

Using the locking ring wrench MT-001, tighten the locking ring to a torque of 0.88 N-m. Do not use pliers. Do not apply excessive force, otherwise the locking ring will become damaged.

Wiring

1. Applicable wire size is 1.25 mm² maximum.
2. Solder the terminals using a soldering iron at 310 to 350°C for 3 seconds maximum. Do not use flow or dip soldering. SnAgCu type lead-free solder is recommended. Make sure that the soldering iron touches the terminals only, not plastic parts. Do not apply external force such as bending the terminals or applying tensile force on the wires.
3. Use a non-corrosive rosin flux. To prevent the flux from entering the switch while soldering, face the terminals downward.

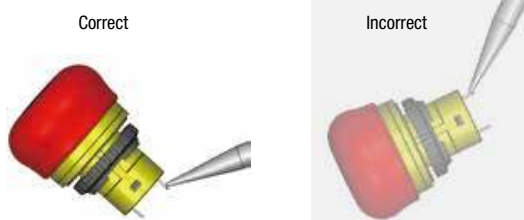

4. Because the terminal spacing is narrow, use protective tubes or heat shrinkable tubes to avoid burning the wire sheath or short circuit.
5. Apply force on the terminals in the vertical direction to the panel only, otherwise the terminals will be damaged.

Notes for Solder/tab terminal #110

1. Use quick connect of #110 and 0.5mm tab thickness.
2. To prevent short-circuit between different poles, use protective tubes or heat shrink tubes.
3. Apply force on the terminals in the vertical direction to the panel only, otherwise the terminals will be damaged.

Contact Bounce

When the button is reset by pulling or turning, the NC contacts will bounce. When designing a control circuit, take the contact bounce time into consideration (reference value: 20 ms).

Handling

Do not expose the switch to excessive shock and vibrations, otherwise the switch may be deformed or damaged, causing malfunction or operation failure.

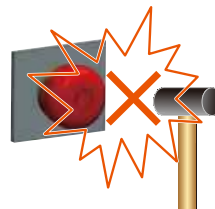

- APEM
- Switches & Pilot Lights
- Control Boxes
- Emergency Stop Switches
- Enabling Switches
- Safety Products
- Explosion Proof
- Terminal Blocks
- Relays & Sockets
- Circuit Protectors
- Power Supplies
- LED Illumination
- Controllers
- Operator Interfaces
- Sensors
- AUTO-ID

- X6
- XA
- XW
- XN
- SEMI

[Download catalogs and CAD from http://eu.idec.com/downloads](http://eu.idec.com/downloads)

D-012