



## OPERATOR'S GUIDE

TruFade Artificial  
Light Fastness Tester

Touch Screen  
Operation Software

Covering Serial  
Numbers  
200/13/1000  
upwards

*Extraordinary*  
*Testing Solutions*

James H. Heal & Co. Ltd.  
Halifax, England

Setting the Standard



Publication 290-200\$B  
© 2013

Published by:

JAMES HEAL LTD.  
RICHMOND WORKS  
HALIFAX  
WEST YORKSHIRE  
HX3 6EP  
ENGLAND

TELEPHONE +44 (0) 1422 366355  
FACSIMILE +44 (0) 1422 352440

E-mail [info@james-heal.co.uk](mailto:info@james-heal.co.uk)  
Internet <http://www.james-heal.co.uk>

© 2013

# TABLE OF CONTENTS

JAMES HEAL .....	5
Setting the Standard.....	5
Areas of Expertise .....	5
Trufade – Artificial Light fastness tester .....	6
Standards .....	7
Safety .....	8
General .....	8
First Time installation .....	9
Introduction to trufade software.....	10
Screen Adjustment .....	10
Welcome Screen .....	10
Menu Screen .....	10
Test Information Screen .....	11
Events Screen .....	11
Standards Screen.....	12
Edit Standards Screen.....	12
Edit Standards Name Screen .....	13
Exposure Screen .....	14
Service Screen .....	14
Lamp Serial Number Screen .....	15
Settings Screen .....	15
Access Code Screen .....	16
Help Screen.....	16
Quick Start .....	17
The Essential Features of TruFade .....	17
Mounting specimens and blue wools.....	21
Guide using the Tri-Sided Sample Holder.....	21
Specimen Holders and Masks .....	22
ISO Specimen Masks .....	24
AATCC Specimen Masks .....	25
Assembling the Lantern .....	26
Installing/replacing the Xenon lamp.....	30
Replacing an Optical Filter.....	32

General Principals of Light Fastness testing .....	36
Specimen Temperature .....	36
Black Standard Thermometer (BST SolarSens) .....	36
Black Panel Thermometer (BPT) .....	36
The Concept of Effective Humidity.....	37
Humidity Test Control Fabric .....	38
Obtaining 40% Effective Humidity.....	38
Determining Effective Humidity.....	39
Nominal Power Mode .....	39
Controlled Irradiance Mode .....	40
Installation.....	41
Installation Requirements .....	41
Electrical Connection.....	41
Heat Output.....	41
WATER SUPPLY .....	42
ISO 3696 - Requirements for Grade 3 Water.....	44
Environment .....	44
Unpacking.....	45
Technical Specification .....	51
Revision History .....	53

# JAMES HEAL

At James Heal, we are dedicated to designing and developing high precision testing instruments and test materials for physical and colour fastness testing. Our worldwide Service and Calibration division and expert technical assistance complement our product range, adding real value to your laboratory testing activities.

## Setting the Standard

We are committed to forming close relationships and have established numerous partnerships within the textile industry, from trade and standards organizations, to test houses, customers and distribution partners.

With a heritage spanning more than 140 years, we have evolved and grown through a culture of continuous improvement, resulting in a thorough understanding of the applications, operating conditions and requirements of customers worldwide – from independent testing Laboratories and test houses, to fabric suppliers, manufacturers and retailers.

Using knowledge and expertise, we consistently set the industry standard through product innovation and technology, with customer and user needs, present and future, driving our technological advancements. You can be assured that with James Heal, you will always receive the highest levels of product quality and customer service. We have Agents and Distribution partners all over the globe, ensuring locally available product whenever, and wherever you need it.

## Areas of Expertise

### Textile: Colour Fastness

- Chlorinated Water
- Dry Cleaning
- Dry Heat
- Hot Pressing
- Laundering
- Light
- Perspiration
- Phenolic Yellowing
- Print Durability
- Rubbing
- Washing
- Water

### Textile: Physical

- Abrasion
- Bursting Strength
- Compression and Puncture
- Crease and Wrinkle Recovery
- Crimp
- Drape
- Durability
- Flammability
- Mass per unit area
- Pilling and Fuzzing
- Security of Attachments
- Seam Slippage
- Shrinkage
- Snagging
- Spray Rating
- Stretch and Recovery
- Surface Deterioration
- Tear Strength
- Tensile Strength
- Washing and Drying

### Non-Textile

- Bursting strength of nonwovens, plastics, paper and medical products
- Micro-scratching of laminates, wooden, painted, automotive and high gloss surfaces
- Physical and colour fastness testing of leather
- Rubbing fastness of laminates and wooden surfaces
- Tear strength of paper and plastics

# TRUFADE – ARTIFICIAL LIGHT FASTNESS TESTER

TruFade is James Heals outstanding next generation Artificial Light Fastness tester. Incorporating James Heals established Xenon arc lamp technology with a revolutionary Tri-Sided specimen holder. 100% compliant with textile and leather light fastness standards.

TruFade is the first James Heal instrument to use our latest touch screen control panel and wonderfully intuitive software. This instrument has been designed to combine James Heals stylish product signature with user centred design for a superb user experience.

## Features

- Sleek, ergonomically designed Artificial Light fastness Tester.
- Proven, high performance, air cooled Xenon Lamp Technology.
- Nominal Power and Irradiance controlled operating modes.
- SolarSens radiometer, incorporating Black Standard Thermometer (BST).
- Spacious design featuring easy loading and unloading of specimen holders.
- Up to 27 sample holder faces giving a total exposure area of 1640cm<sup>2</sup>.
- Complies with International Testing standards for textile and leather.
- Close control of chamber temperature and humidity.
- Easy editing of pre-programmed standards and creation of bespoke testing conditions.
- Simple and intuitive touch screen control panel.
- 'Three Clicks' to start testing !



## Service and Calibration

- Worldwide Service
- ISO 17025 based Calibration Service
- 18 Months' Warranty

## Technical Assistance

- Operator Training
- Knowledge transfer
- Applications Support
- Engineering Support

# STANDARDS

TruFade conforms to the following standards;

AATCC 16.3:2012 Option 2  
AATCC 16.3:2012 Option 3  
AATCC Test Method 16:2003 Option 3  
AATCC Test Method 16:2003 Option 5  
AATCC Test Method 169:2003 Option 1  
AATCC Test Method 169:2003 Option 3

EN ISO 105 B02:1999 Extreme High EH  
EN ISO 105 B02:1999 Extreme Low EH  
EN ISO 105 B02:1999 Normal Conditions  
EN ISO 105 B02:1999 American Conditions  
ISO 11341:2004 Test method 2C  
ISO 12040:1997

M&S C9:2009  
M&S C9A:2009

The TruFade is an extremely versatile instrument capable of achieving a wide range of conditions.

The list below details test methods currently pre-programmed into TruFade.

Standard 1	AATCC TM16- 2003 Option 3
Standard 2	EN ISO 105-B02:1999 – Controlled Irradiance Method
Standard 3	EN ISO 105-B02:1999 – Nominal Power Method
Standard 4	M&S C9/C9A:2009 – Controlled Irradiance Method
Standard 5	M&S C9/C9A:2009 – Nominal Power Method

Should you wish to use TruFade for a test method not specified above, or for a variation of the pre-defined parameters for any of the standards above, the user has the option to create or amend methods. Select 'Edit Standards' Screen (Page 13) for further information.

# SAFETY

## General

TruFade has been specifically designed with the Operator's health and safety in mind. All touch points are engineered to give an excellent and safe user experience.

To ensure your safety, please observe the following points at all times:

- Read this manual carefully before operating the machine
- Observe the installation requirements for correct machine performance
- Items in the test chamber can become hot during a test – exercise caution when handling and use gloves where necessary
- Always allow the machine to cool down sufficiently before handling the lamp or optical filters
- Never place flammable or explosive materials in the test chamber
- Never operate the machine without a full complement of optical filters, specimen holders and borosilicate cylinder
- Only use the manufacturer's approved spare parts and consumables
- Have the machine serviced at least once a year by a James Heal Service and Calibration Engineer.



Following good health and safety practice, before removing or replacing the Lantern assembly, Optical Filters or Xenon Lamp always isolate the electrical supply to avoid danger of electrical shock !



# FIRST TIME INSTALLATION

If you are commissioning the TruFade unit, please read the following sections in the following order.

**Note:** They may not necessarily appear in the same order in the manual as listed below. If you are using a softcopy of the manual, you can click on each section in turn in the contents menu and the document will automatically skip to the correct page.

- Unpacking
- Installation - Including all subsections
- Assembling the Lantern
- Installing/Replacing the Xenon Lamp
- Introduction to the TruFade Software
- The General Principles of Light Fastness – Including all subsections

Once the TruFade is commissioned, please read

- Mounting specimens and Blue Wools – including all subsections
- Quick Start – including all subsections

# INTRODUCTION TO TRUFADE SOFTWARE

The TruFade software has been designed completely with the user in mind. You can configure it to be as simple or as comprehensive as you wish.

Amongst its many unique features you can:

- Choose your Standard from a pre-programmed list or even define your own.
- Run the machine continuously or set it to stop automatically after a period of time or at specific time of day.
- Keep track of how long your samples have been in the machine.
- For easy maintenance, the software keeps track of lamp and optical filter life and alerts the user when things need changing.



## Screen Adjustment

The touch screen angle of viewing can be adjusted to suit the user.

To do this, press and hold the button highlighted by the blue circle and at the same time as **holding** the button, lift or lower the screen manually until it is in a suitable position, by lifting or lowering the screen at the point of the blue rectangle.



## Welcome Screen

With the power connected the software will initialise and the TruFade welcome screen will be displayed.



## Menu Screen

This menu gives you access to the various screens in the software:

**Test Information** - Press this when you are ready to start a test.

**Standard** - Choose from a list of pre-programmed Standards or define your own.

**Timer** - Select a Timer to automatically stop the machine after a period of hours or set one that stops at a specific time of day.

**Exposure** - Provides comprehensive sample management and reports the total sample exposure in kJ/m<sup>2</sup> or hours for each sample holder.

**Service** - For easy maintenance, this screen shows you the status of the Xenon Lamp and the Optical Filters.

**Settings** - Provides adjustments for various settings such as date, time, language etc.

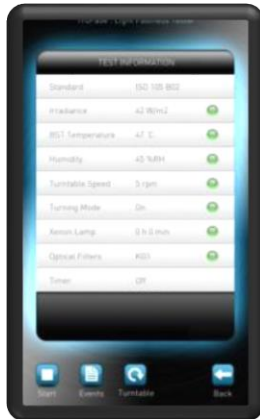

## Test Information Screen

Here all the important test parameter settings are displayed and controlled throughout a test.

A row of green status lights indicate that things are working correctly.

It is normal to see the Temperature and Humidity status light turn red at the start of a test while the chamber conditions stabilise.

**Start/Stop** - Start or Stop a test.

**Events** - Displays a list of events that occurred during the test.

**Turntable** - Rotates the turntable giving you access to more sample holders.

**Back** - Returns you to the Menu Screen.



## Events Screen

Test events are recorded here. These include when tests are started or stopped, when the Xenon lamp has been changed and any system messages.

It is possible to log how the machine has performed throughout a test by turning on the Data Logger feature on the Settings Screen.

Up to 100 events can be viewed over five pages. The events will automatically overwrite so you can always review what's been going on when the machine has been left unattended.

**Up** - Scrolls the screen up one page.

**Down** - Scrolls the screen down one page.

**Back** - Returns you to the Menu Screen.



## Standards Screen

There are five pre-programmed and five user defined Standards available.

Some use the traditional Blue Wool references and others use controlled irradiance.

The blue highlight bar shows the currently selected Standard.

Touch a Standards name to select it.

You can prevent users from changing the Standard by locking this screen in the Settings Menu.

**View** - View the selected Standard settings.

**Undo** - Undo any changes you have made.

**Back** - Returns back to the Menu Screen.



## Edit Standards Screen

These are the settings for the currently selected Standard.

Each setting is freely programmable.

Touch "Edit" to enable editing. The blue highlight bar will appear. Touch the setting you which to change then use the Up/Down arrows to alter the value.

You can prevent users from changing the settings by locking the Standard Menu in the Settings Menu.

**Edit** - Toggles the highlight bar On or Off for parameter editing.

**Factory** - Resets all the Standards parameters back to their original factory settings.

**Undo** - Undo any changes you have made.

**Back** - Returns you to the Menu Screen.



## Edit Standards Name Screen

When editing a Standard you may wish to rename it.

A name can be up to 15 characters long and contain letters, numbers and spaces.

**Esc** - Escape editing without making any changes to the name.

**Space** - Inserts a blank character.

**Del** - Deletes a character from the end of the name.

**Enter** - Returns you to the Edit Standard Screen.



## Timer Screen

You can use the Timer to stop the test automatically after a certain number of hours or at a specific time of day.

If you wish to run the machine continuously and stop it whenever you like, simply turn the Timer Off.

Each timer is freely programmable and can be customised as you wish.

Touch the Timer name to select it.

Touch "Edit" to enable editing. Touch the Timer you which to change then use the arrows to alter the value. Then touch Edit again to confirm your entry.

**On/Off** - Toggles the Timer On or Off.

**Edit** - Enables editing of the selected Timer.

**Undo** - Undo any changes you have made.

**Back** - Returns you to the Menu Screen.



## Exposure Screen

This feature lets you keep track of how long your samples have been in the machine. It records the exposure time for each face of a 3-sided sample holder. The exposure times accumulate until you reset them.

You can reset individual sides of a sample holder by just touching its value. Touching the blue sample holder image resets all three sides at once. **Reset All** quickly zero's all of the values.

For Standards that use controlled irradiance, touch the Sample Exposure title bar and you can toggle the values between hours and kJ/m<sup>2</sup>.

If you remove a specimen and intend to keep the machine running, use the **Hold** function to freeze its value until the specimen is returned.

**On/Off** - Toggles the Sample Exposure feature **On** or **Off**.

**Hold/Reset** - Toggles between Hold or Reset functions.

**Turntable** - Rotates the turntable.

**Undo** - Undo any changes you have made.

**Back** - Returns you to the Menu Screen.



## Service Screen

For easy maintenance, the software keeps track of lamp and optical filter life and alerts you when things need changing.

A red status light indicates an item requires changing.

When an item has been replaced simply touch the items panel to reset it.

**Help** - Displays help screens showing you how to replace a lamp or optical filter.

**Undo** - Undo any changes you have made.

**Back** - Returns you to the Menu Screen.



## Lamp Serial Number Screen

When replacing a Xenon Lamp, you will be asked to enter the new lamps serial number. It is important that this is entered correctly to validate its warranty.

Use “+” and “-“ to change the respective numbers.

Should you ever have to return a lamp under warranty, touch its serial number and make a note of the warranty claim number that is generated. Send this back to us along with the lamp.

**Undo** - Undo any changes you have made.

**Back** - Returns you to the Menu Screen.

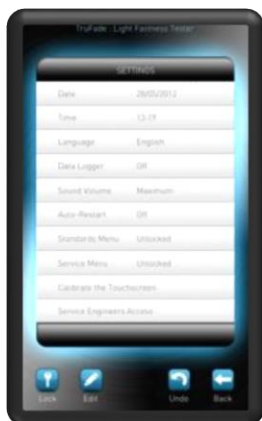

## Settings Screen

**Date & Time** - Today's date in dd/mm/yyyy format and time in 24h clock format.

**Language** - Selection of English, French, German, Spanish and Italian languages.

**Sound Volume** - Adjusts the loudness of the machine sounds.

**Auto-Restart** - Automatically resumes the test should the power fail mid-test.

**Standards Lock** - Set this to *Locked* if you wish to prevent users from making any changes to the selected Standard.

**Service Lock** - Set this to *Locked* if you wish to prevent users from making any changes to the Service Screen.

**Calibrate the Touchscreen** - Touch each corner of the screen to re-calibrate the touchscreen.

**Service Engineers Access** - is reserved for authorised personnel use only.

**Lock** - Toggles the Settings Screen Lock **On** or **Off**.

**Edit** - Enables editing of the selected Setting.

**Undo** - Undo any changes you have made.

**Back** - Returns you to the Menu Screen.



## Access Code Screen

To prevent unauthorised changes to the machines setting you can “Lock” the Settings Screen.

To enable the lock touch the “Lock” key and type **0200** then press Enter.

To remove the lock touch the “Unlock” key and type **0200** then press Enter.

Always keep this number confidential to prevent anyone tampering with the machines settings.

**Esc** - Escape this screen.

**Enter** - Confirms your access code entry.

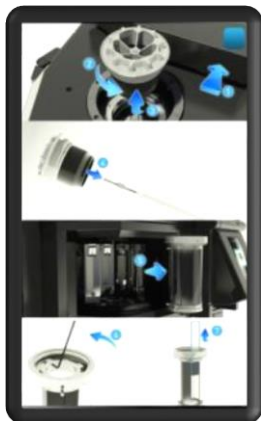

## Help Screen

To assist the use user with replacing Xenon Lamps and Optical Filters, the help screen provides an easy to follow pictorial guide.



# QUICK START

## The Essential Features of TruFade

The following section will guide you quickly through the simple steps of carrying out a Light Fastness test to either ISO 105-B02 or AATCC Method 16.

If you have recently taken delivery of your **TruFade** and have not yet unpackaged and assembled it, please see the three sections '[Unpacking, Assembling the lantern & Installing/Replacing the Xenon Lamp](#)' before commencing testing as below.



Once you have commissioned your TruFade and connected the power, you will be presented with the TruFade Welcome Screen on the touch screen control.

**Note:** If this is the first time you have connected the power after commissioning the TruFade, you will be presented to the 'Lamp serial number screen' Input the serial number from your lamp (this can be found on the lamp box)

Press anywhere on the screen to access the Menu Screen.

The Menu Screen allows access to the setup features of the TruFade.

Press the  icon to enter the Standards Screen



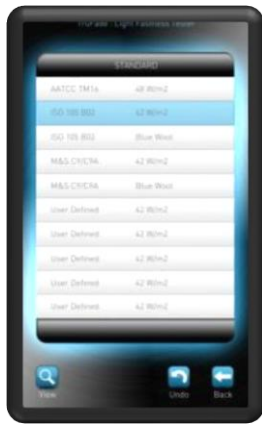

On the Standards Screen you will be presented with a list of the pre-programmed standards.

Each pre-programmed standard has the entire set of test parameters associated with that standard pre-defined. This includes, where appropriate, Irradiance, temperature, and relative humidity.

Simply touch the required test standard from the list, and then press the  icon to return the Menu Screen.



Now you have selected the standard you require, you can define the length of time you want to run the test for.

Press the  icon and you will access the Timer Screen.





You can use the timer to stop the test after a certain number of hours or a certain time of day. There are several predefined time periods that you can select by touching them.

If you wish to run the test continuously without setting an end time, you can turn off the time by pressing the  icon.



If the test duration you require is not available, you can edit one of the predefined slots.

Simply press the time you wish to edit and touch the  icon. Use the up and down icons to adjust the time.

Once you have selected the test time you require, touch the  icon to return to the Menu Screen.



Now you have selected your standard for testing and the required duration of the test press the James Heal icon on the Menu Screen. This will take you to the Test Information Screen.

**Note:** if you wish to perform a test to the same standard and duration the next time you operate TruFade, you do not need to access the Standards & Timer Screen again.

Pressing the James Heal icon will default to the last set of parameters selected.



The Test Information Screen displays all of the parameters defined in the test you are about to perform. At this stage you can review all parameters before testing begins.

If you are satisfied that the parameters are correct and that you have your specimens correctly inside the testing chamber you can press the  icon.

The test will now begin and will only end if you press  or when the user defined duration is reached.

**Note:** Once the test is running, the information on the Test Information Screen displays live information taken from measurements within the test chamber. It is not unusual for the status light to turn red at the beginning of a test whilst the chamber conditions are stabilising.

Congratulations - you have successfully started using **TruFade**

# MOUNTING SPECIMENS AND BLUE WOOLS

## Guide using the Tri-Sided Sample Holder

The TruFade used a revolutionary Tri-Sided specimen holder in order to maximise the available test area.

Specimens are mounted on OBA free white specimen card and placed in the specimen holder with a mask to ensure that comparison can be made between the irradiated and non-irradiated section of the specimen.

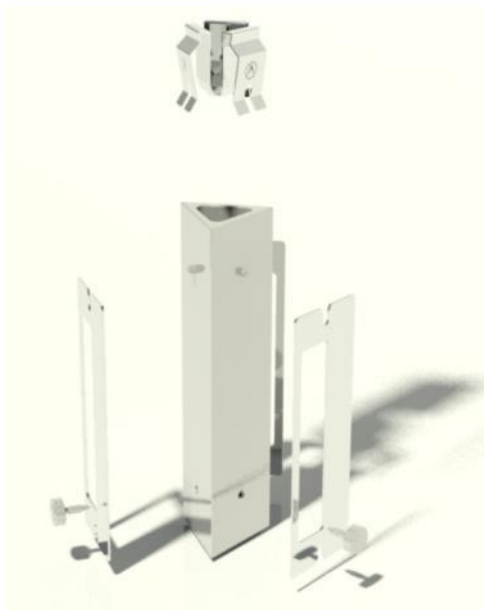

The easy to assemble Tri-Faced specimen holder consists of 3 main parts.

1. The main body
2. The specimen masks
3. The specimen mask clips

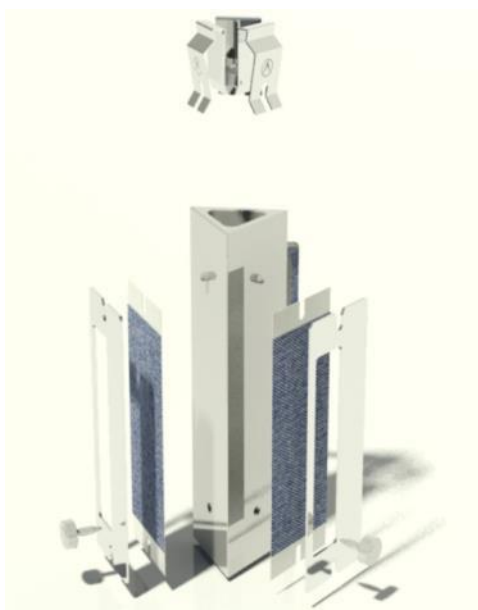

Your specimens and Blue Wool Wools are mounted on James Heal OBA free specimen card. This card has been designed to fit perfectly in to the Tri-Sided Specimen Holder.

Specimens are positioned between the main body of the specimen holder and the specimen mask.



Next fit the specimen masks to the main body of the specimen holder.

Do this by locating the notched edge on the specimen mask on to the location pin on the main body of the specimen holder.

This is highlighted by the blue circle on the picture.

Next attach the thumb screws in to the screw holes in the main body of the specimen holder.

This is highlighted by the Blue arrow on the picture.



Finally lower the clips down to securely attach the specimen mask to the main body of the sample holder.

Your specimens are now ready to test.

## Specimen Holders and Masks

- The standard specimen holders are designed to accept specimens with a maximum test area 10cm x 4.5cm, and up to 3mm thick.
- Samples can be mounted to all 3 sides of the specimen holder and up to 9 specimen holders can be inserted into the carousel at any one time, giving a total of 27 specimen faces.
- To insert specimen holders, open the test chamber door and locate the specimen holders on the triangular blocks on the machine carousel. There is a triangular recess on the bottom of the specimen holder that this fits over the triangular blocks to secure the specimen holder to the carousel.
- Press the  icon to rotate the carousel to access the block at the back of the chamber.
- When handling the specimen holders, ensure that you do not touch the specimen face as this may soil the test specimens and affect results obtained.

- **Note:** if using SolarSens for 'Black Standard Temperature (BST) Control' and/or 'Controlled Irradiance Mode', then only 8 specimen holders will be available.
- Specimens are usually mounted onto OBA free white specimen card via use of small staples, unless otherwise specified in the test method.
- Any material placed between the specimen and specimen holder may affect the specimen surface temperature and may ultimately affect the results obtained.
- If specimens are not being used in every specimen holder during the test, ensure that OBA free card is placed in the unused specimen holders, unless otherwise specified in the test. This will ensure reproducible exposure and that the aerodynamics within the test chamber remains unaffected.
- A variety of masks are available to ensure that comparison may be made between the irradiated and non-irradiated sections of the specimens. Masks are specified within the test methods. See the next page for range of masks available.

# ISO Specimen Masks

Specimen masks allow you to make comparisons between exposed and un-exposed areas of the specimen and any control materials used.

## Masks for ISO 105-B02: Method 1



Single slot mask giving 2/3 cover



Double slot masks giving 1/3 cover

## Masks for ISO 105-B02 : Method 2



Single slot mask giving quarter ( $\frac{1}{4}$ ) cover



Single slot mask giving half ( $\frac{1}{2}$ ) cover



Single slot mask giving three-quarters ( $\frac{3}{4}$ ) cover



## AATCC Specimen Masks

Special AATCC masks are available to ensure that the exposed areas conform to AATCC specifications.



Double slot mask with exposed areas  
30x30mm



Double slot mask with exposed areas  
30x15mm

## ASSEMBLING THE LANTERN



The Lantern assembly is packaged separately to the main TruFade unit.

We recommend unpacking all the components before attempting assembly. You will have all of the parts in this picture (left).



First place the Borosilicate Cylinder onto the Bottom End Cap (the smallest End Cap). This will form the base of the Lantern assembly.

Ensure that the 3 holes in the Borosilicate Cylinder are aligned with the screw holes on the Bottom End Cap.

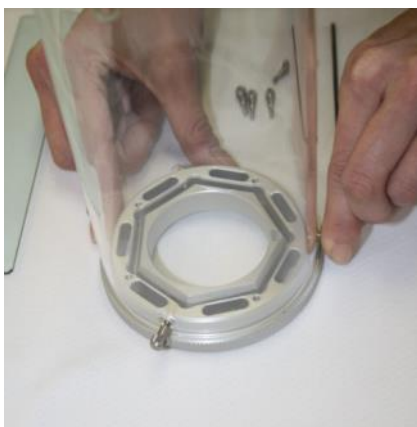

Next insert 3 of the thumb-screws into the screw holes in the Bottom End Cap. This will secure the Borosilicate Cylinder to the End Cap.



Now carefully lower the Top End Cap (largest End Cap) onto the Borosilicate Cylinder.

Ensure that the 3 screw holes on the Top End Cap are aligned with the 3 hole on the Borosilicate Cylinder.



Insert the remaining 3 thumb screws in to the screw holes on the Top End Cap.

This will secure the Top End Cap to the Borosilicate Cylinder.

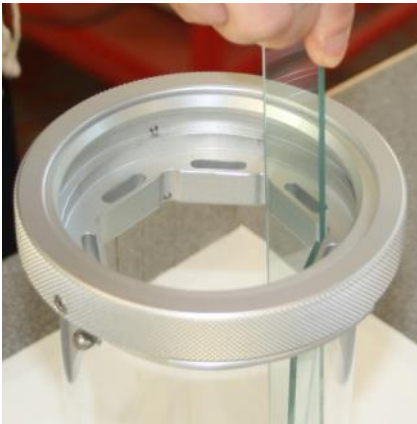

Next insert the 7 KG1 filters. Do this by carefully lowering each individual filter through the hole in the Top End Cap and locate them in the slots in the Bottom End Cap (see picture).

**Note:** Do not touch the surface of the KG1 Filters. Always handle them on the edges.

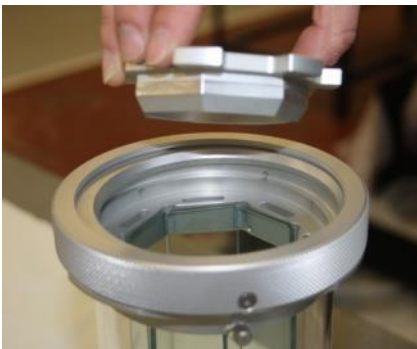

Insert the Top End Cap Plate into the top End Cap. This is used to secure the KG1 filters inside the Borosilicate Cylinder.



The Top End Cap Plate should be located in an orientation that ensures none of the ventilation slots are covered (see picture).



Finally, use a 2mm A/F Allen Key to secure the Allen Screw (See Picture).



If correctly assembled, your Lantern will be the same as this picture.

Before moving the Lantern, ensure that all screws are correctly secured and tightened.

**Note:** When moving the Lantern, always use both hands to reduce the risk of damage to the Lantern and minimise the contact with the Borosilicate Cylinder.

If any fingerprints are left on the Borosilicate Cylinder, they can be cleaned with a mild detergent such as Neutracon or Decon dispersed in warm water, followed by rinsing in grade 3 water.

Detergent must be free from OBAs.

Dry with lint-free cloth.



To position the Lantern inside the TruFade chamber find the location notch (highlighted by the white circle) on the Bottom End Cap.



Following good health and safety practice, before removing or replacing the Lantern assembly always isolate the electrical supply to avoid danger of electrical shock !

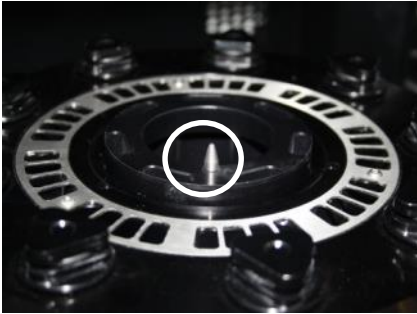

This notch fits onto the location pin (highlighted by the white circle) on the Carousel inside the TruFade chamber.

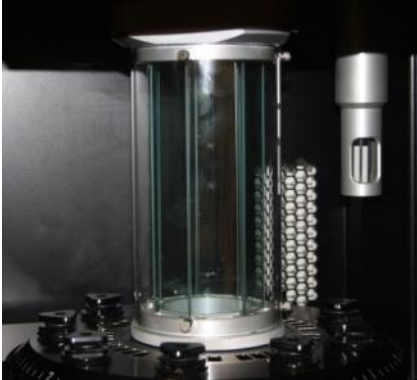

Once correctly located, the Lantern will sit inside the TruFade chamber as in this picture.

# INSTALLING/REPLACING THE XENON LAMP

When your Xenon Lamp has performed 1500 hours of testing the TruFade touch screen will inform you that it is time to replace the lamp.

Before you do this, ensure that you have made a note of the lamp serial number as you will be required to enter this in to the TruFade software to finish the installation.

If you are installing the Xenon Lamp to commission the TruFade, please ensure that the lantern unit is assembled and installed first as in the previous section '[Assembling the Lantern](#)'

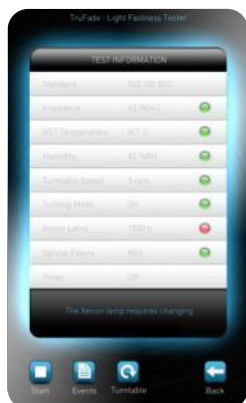

After 1500 Hours of testing the test information screen will inform the user it is time to replace the Xenon Lamp. No further testing can be performed until this is completed.



Following good health and safety practice, before removing or replacing the Xenon Lamp or Optical Filters always isolate the electrical supply to avoid danger of electrical shock !



To install or replace your Xenon Lamp, first slide the Top Connector away to expose the Lamp Connector.

Do this by pushing the Top Connector in the direction of the arrow.



Turn the Lamp Connector anti-clockwise to release it.

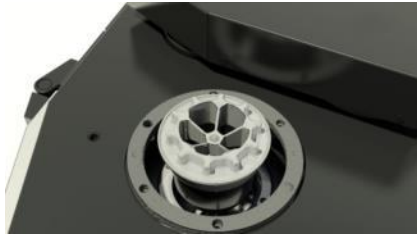

Now lift the Lamp Connector upwards and out of the TruFade.

**Note:** If you are replacing an installed lamp, take care when lifting the Lamp Connector as the Xenon Lamp will still be attached.



Remove the old lamp (if applicable) & Insert the new Xenon Lamp in to the Lamp Connector.

**Note:** You MUST insert the thinnest metal connector on the Xenon Lamp into the Lamp Connector. The correct end is engraved with the James Heal logo.



Once fully inserted, lower the Lamp Connector back into position.



Ensure that the lamp is carefully lowered so as not to cause any damage to either the Xenon lamp or the KG1 filters inside the Lantern.

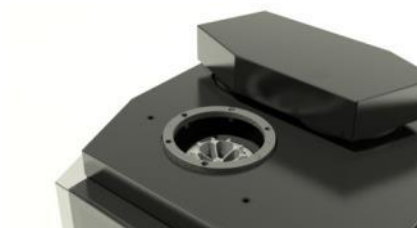

To lock the Lamp Connector, turn it clockwise until it cannot be turned any further; take care not to over tighten Lamp Connector.



Return the Top Connector back to its locked position by sliding it in the direction of the arrow.

## Replacing an Optical Filter

TruFade will show a warning message when an optical filter needs to be replaced. This is when the filter has been used for 500 hours of testing.

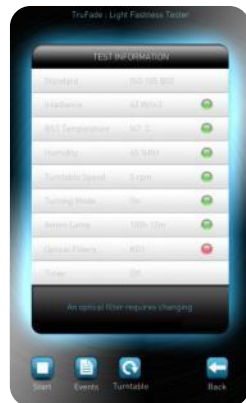

After 500 Hours of testing the test information screen will inform the user it is time to replace an Optical Filter. No further testing can be performed until this is completed.



Following good health and safety practice, before removing or replacing the Xenon Lamp or Optical Filters always isolate the electrical supply to avoid danger of electrical shock !



First you will need to remove your Xenon Lamp. First slide the Top Connector away to expose the Lamp Connector.

Do this by pushing the Top Connector in the direction of the arrow.

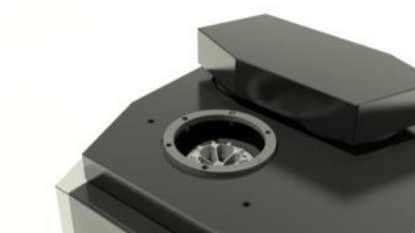

Turn the Lamp Connector anti-clockwise to release it.



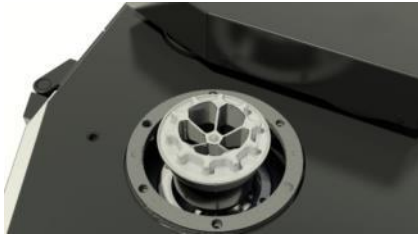

Now lift the Lamp Connector upwards and out of the TruFade.

**Note:** Take care to remove the lamp vertically so as not to damage the lamp or the Optical Filters.

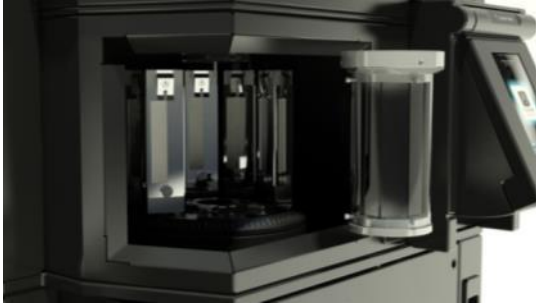

Remove the lantern assembly. Taking care to handle the lantern on the end connectors. Avoid contact with the Borosilicate Cylinder.



Use a 2mm A/F Allen Key to release the top end cap plate.

Lift out the top end cap plate to allow access to the Optical Filters.



Remove the appropriate Optical Filter and replace with a new one.

**Note:** Care must be taken to handle the new Optical Filter at the edges to ensure no fingerprints are left on the surface of the filter.



Replace the top end cap plate and secure using the 2mm A/F Allen Key.

**Note:** The top end cap plate should be positioned in an orientation that ensures none of the ventilation holes are covered.

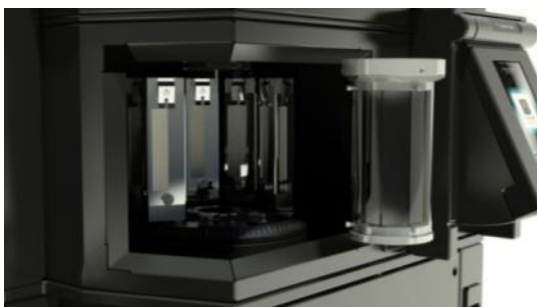

Replace the lantern assembly back in to the TruFade testing chamber



Replace the Xenon Lamp and secure the lamp connector by turning it clockwise until it cannot be turned further.

**Note:** Do not over tighten the lamp connector.



Return the Top Connector back to its locked position by sliding it in the direction of the arrow.

# GENERAL PRINCIPALS OF LIGHT FASTNESS TESTING

## Specimen Temperature

Including setting black standard or black panel temperature. Specimen temperature is important as it has an effect on the rate of fade of the specimen. There are two methods of controlling and/or monitoring specimen temperature:

1. Black Standard Thermometer (BST) via SolarSens
2. Black Panel Thermometer (BPT)

Both are designed to show the maximum surface temperature a specimen could reach.

Prior to running test specimens, it is recommended that the test programme is run to ensure that the black standard/black panel temperature is correct. Please see below for more details.

## Black Standard Thermometer (BST SolarSens)

SolarSens may be utilised to automatically control the Black Standard Temperature.



James Heal - SolarSens™

## Black Panel Thermometer (BPT)

The Black Panel temperature is controlled by the Chamber Temperature setting in the selected Standard. If the Black Panel temperature is too low, increase the Chamber Temperature setting in the Standard definition.

To edit this value, select the “Standards Screen” then select “Edit” and change the Chamber Temperature setting.

To check the maximum specimen temperature, ensure either the SolarSens or BPT are in the test chamber and run the TruFade for at least 60 minutes. After this warm-up period, the SolarSens temperature reading will have stabilised and will be working within its parameters.

When using BPT, view the temperature on the panel, through the chamber door window.

Due to the high temperatures these thermometers can reach, it is advisable to wear gloves when handling them. Use SolarSens or BPT regularly to check the temperature, or whenever a Standard is changed.



Black Panel Thermometer

## The Concept of Effective Humidity

ISO 105 B02 specifies that users set and check the Effective Humidity using the procedure described in section above at least every 6 months.

In order to make light fastness testing instruments from different manufacturers comparable, Test Methods generally refer to measurable parameters rather than specific machine settings. Therefore, it is important to distinguish between Effective Humidity and Chamber Humidity. The Effective Humidity, as measured by the Humidity Test Control Fabric, is the level of humidity the test specimen's experience. Chamber Humidity is measured electronically and monitored continuously. It is not practical to continuously monitor the Humidity Test Control Fabric and so the Chamber Humidity is used as a means of achieving the desired Effective Humidity.

In TruFade, an Effective Humidity of 40% is achieved (when the instrument is located in an air conditioned room at 20°C and 65% RH) with the Chamber Humidity set at approximately 40%. In another manufacturer's equipment the set point could be 70% to achieve the same Effective Humidity.

Chamber Humidity is a set point used to achieve the desired Effective Humidity.

# Humidity Test Control Fabric

Described in EN ISO 105-B02:1999 is a method for determining the effective humidity of a test chamber. This is based on the use of cotton fabric dyed with a red azoic dye.

This method is summarised below.

## Obtaining 40% Effective Humidity





Mount and partially cover a strip of the Humidity Test Control Fabric (red azoic dyed cotton fabric) and Light Fastness Standard 5 in the normal manner and expose until one or both have faded to an extent visually equal to Grey Scale Grade 4. Compare the amount of fading on the two strips.

If both have faded to the same extent, the lamp was operating at the preferred effective humidity of 40%.

If the Humidity Test Control has faded more than Standard 5, the effective humidity is too high and the chamber humidity must be lowered and the exposure repeated.

If Standard 5 has faded more than the Humidity Test Control, the effective humidity is too low and chamber humidity must be raised and the exposure repeated.

**Note:** To raise or lower the chamber humidity follow the steps below

- If you are in the 'Test Information' Screen, press the  icon. This will return you to the 'Menu' screen.
- Once in the 'Menu' screen, press the  icon to go to the 'Standards' screen and press the ISO 105-B02 standard which you wish to edit and press the  icon enter the Edit Standard screen.
- Press the  icon to edit the settings. Press 'Humidity'.
- Using the 'up' and 'down' arrows, adjust the humidity in the required direction and. When you have adjusted to the desired humidity, press the  icon until you return to the 'Menu' screen.

## Determining Effective Humidity

Determine the colour fastness to light of the Humidity Test Control Fabric by the method described in EN ISO 105-B02:1999. The effective humidity during the period of exposure can be obtained from the graph below.

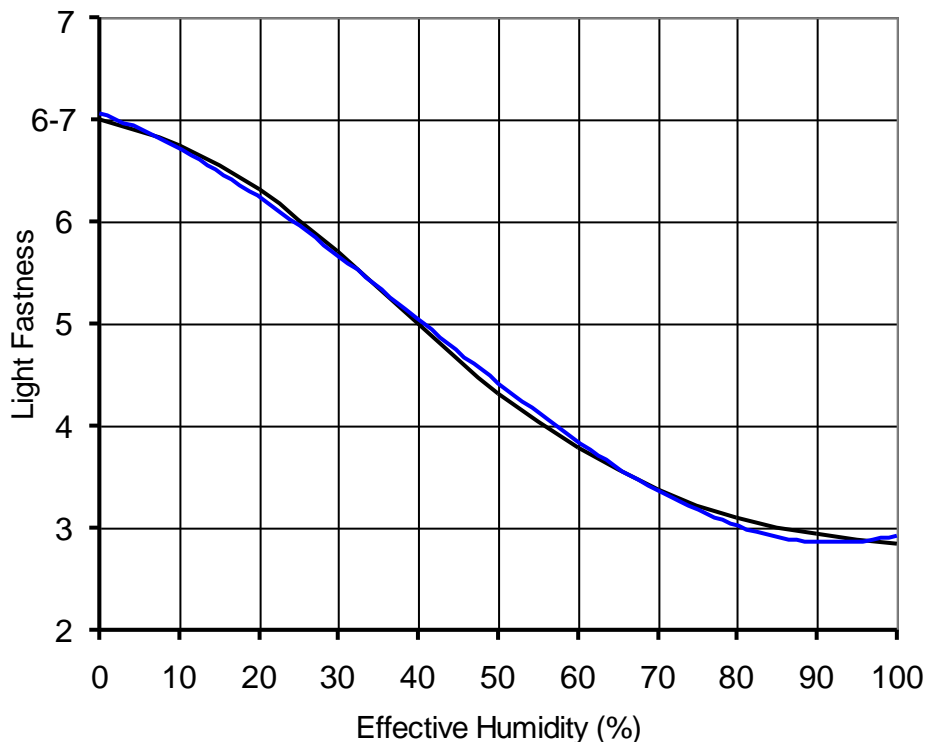

## Nominal Power Mode

Blue Wool Reference standards have been utilised for many years to determine the end point of testing and to assess specimen fade. Typically, two sets of Blue Wools Reference standards are available:

- European (Blue Wool 1-8)
- USA (L2-L9).

The Blue Wool Reference standards are mounted on OBA free card and exposed to light and weathering programmes simultaneously with the tested specimens. At the end of testing, the specimens are compared to the Blue Wool Reference Standards and assessed accordingly.

To operate in nominal power mode, you must select 'ISO 105-B02 – Blue Wool' From the 'Standards' Screen. Should you wish to alter this power setting to modify chamber temperature or black panel/black standard temperature, please refer to section 'Edit Standards Screen'.

If you are using a Black Panel Thermometer to set your specimen temperature, it is not necessary to use SolarSens. Once the Black Panel Temperature is set, you may start testing using all 9 specimen holders.

## Controlled Irradiance Mode

Although many light fastness standards use blue wools as a means of grading the amount of fade, defining the level of irradiance is now becoming more popular.

SolarSens is used to measure the light. It then uses this data to keep the light output constant by adjusting the lamp power. In line with AATCC Test Methods, SolarSens uses a sensor measuring at a wavelength range of 300-400nm. Ensuring the correct lamp power output is consistently maintained during the entire test and the entire life of the lamp.

Tests can be performed to a specific total irradiance, or again, Blue Wool Reference Standards can be utilised at the same time as SolarSens to determine the end point of the test. The Blue Wool Reference Standards are also used to assess the fading of the specimens.



# INSTALLATION

## Installation Requirements

- Footprint** The TruFade has a footprint of 754 x 795. Please note that sufficient free space must be allowed at the front of the TruFade to allow the chamber door to open to inset or remove specimen holders.
- Height** The TruFade is 1610mm tall. Please note that the user must allow sufficient free height about the TruFade to replace the Xenon Lamp.

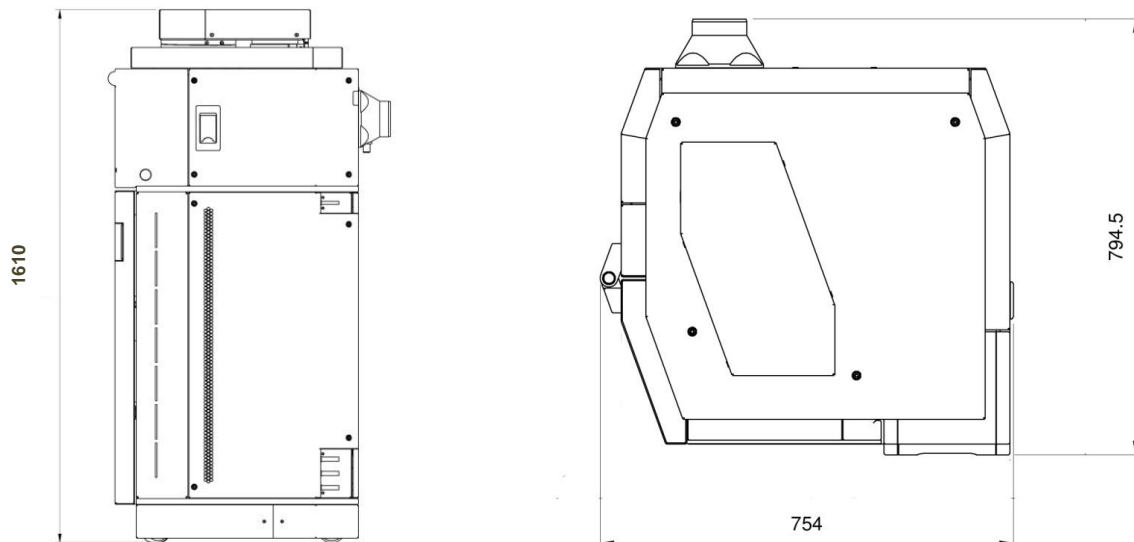

## Electrical Connection

- The unit is designed for a single-phase mains supply of nominally 230V 50/60 Hz with a maximum power consumption of 3.25kW. Where 110V is the nominal supply voltage, TruFade must be connected across two phases to achieve 220V.  
**One single-phase 110V supply is not suitable.**
- Attach the mains inlet cable to a fused isolator rated at 16A. A plug and socket can be used in addition to the fused isolator if required.  
**It is advisable to discuss these requirements with your works electrician.**
- Prior to installation, check the serial number plate on the rear of the unit to confirm the voltage, frequency and phase are in accordance with your local requirements.

## Heat Output

- The xenon lamp is air-cooled and the heat generated is exhausted at the rear of the TruFade.
- The warm air is discharged at a rate of 340 m<sup>3</sup>/h at approximately 50°C.
- The discharge does not contain ozone and is not detrimental to health.
- When an air conditioning unit cannot accommodate the 2kW heat output, the exhaust should be vented outside the room with 100mm internal diameter hose.

- A 1.5m length of flexible hose is available as an optional extra – order code **327-290**.
- Where an exhaust hose of greater than 1.5m is required, the heat discharge must be fan assisted.

## WATER SUPPLY

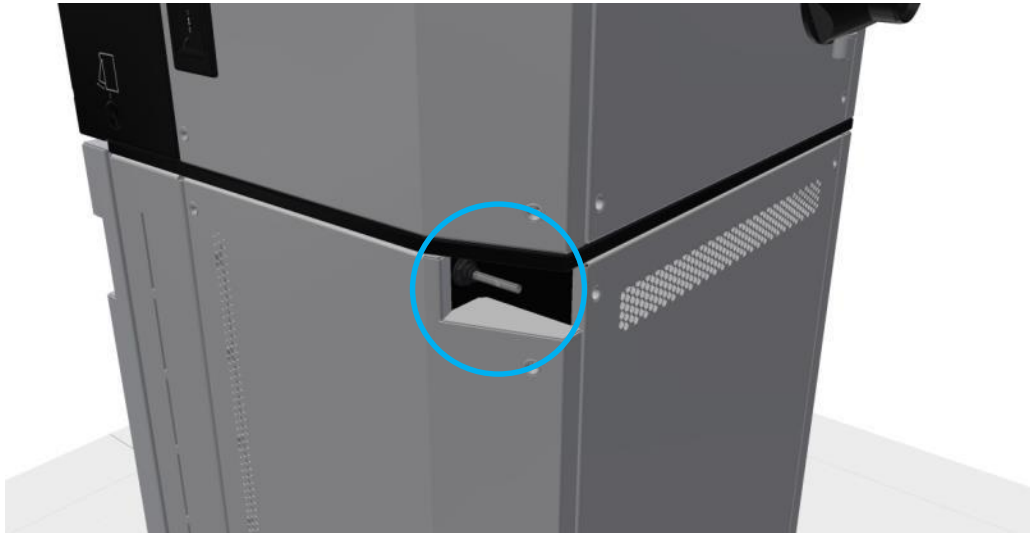

- A continuous supply of distilled water or water complying with ISO 3696, minimum Grade 3 is required. For example, ISO 3696 Grade 3, 2 & 1 are all acceptable. It may be piped directly into the TruFade via the water inlet highlighted by the blue circle above, or through the internal water reservoir.
- Water consumption is dependent on ambient humidity and the desired effective humidity. The maximum water consumption is 1.6 litres/hour when using humidification only. Under normal laboratory conditions, consumption is approximately 200 ml/hour to achieve ISO 105-B02 normal humidity conditions.



- The TruFade has 2 overflow outlets highlighted by the blue circle on the image above these are for the internal water reservoir and the humidity tank. These require connection to a drain. If a nominal 32mm (1¼") diameter free drain is not available a container can be used, but this will need emptying periodically.
- The internal water reservoir can hold up to 32 litres of deionised water. This can be accessed and filled by following the diagrams below.



Open the large door on the front of the TruFade. This will allow access to the internal water reservoir.

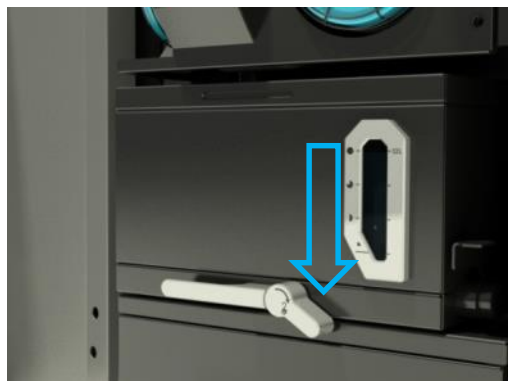

Push the locking handle down in the direction on the blue arrow and hold it down.



Pull the reservoir towards you and lift the lid as shown in the picture.

Fill with deionised water to the correct grade.

**Note:** Before you can relocate the reservoir back in to the TruFade, you must push and hold down the locking handle in the same way as if pulling the reservoir outwards.

- The water reservoir inside the unit feed water in to the humidity tank in the same way as a direct water feed would. If the water level is low in the water reservoir, the TruFade will indicate the water needs to be topped up.
- Should there be a failure in the water supply either direct or from the internal reservoir, the humidity tank will maintain running. Should the humidity tank run low, the test will stop and a 'Reservoir water level low' warning will be displayed. Once the water supply has been restored, the test can be resumed by touching the 'Start' icon.
- Should you require water purification equipment we can offer details of a suitable package, which satisfies the requirements of TruFade.
- TruFade utilises common push-fit connections for which 5 metres of Ø8mm and 5m of Ø12mm tube are supplied.

## ISO 3696 - Requirements for Grade 3 Water

Suitable for most laboratory wet chemistry work and preparation of reagent solutions; should, for example, be produced by single distillation, by deionisation, or by reverse osmosis. Unless otherwise specified, it should be used for ordinary analytical work.

**Note:** It is assumed that the initial feed stock water is potable (drinking quality) and reasonably pure. If it is heavily contaminated in any respect, some pre-treatment may be necessary.

Parameter	Grade 3
pH value at 25°C inclusive range	5.0 to 7.5
Electrical conductivity mS/m at 25°C, max.	0.5
Oxidisable matter, Oxygen (O) content mg/l, max.	0.4
Residue after evaporation on heating at 110°C mg/kg, max.	2

## Environment

To achieve the widest range of chamber performance, we recommend ambient conditions of 20°C and 65% RH.

It is therefore recommended that you TruFade is installed in a standard conditioned environment suitable for textile testing.

TruFade will operate satisfactorily in the following environment.

- Recommended Ambient Temperature Range 16 - 24°C
- Recommended Ambient Humidity Range 30 - 65%RH (non-condensing)

# UNPACKING

Read all of these instructions before beginning to unpack the instrument.  
Before unpacking, transport the box to the room where the instrument is to be located.



Remove this side of the pallet first



Using a power tool or screw driver remove the screws

Screws can be found down both edges of the pallet.



Once the first side has been removed,  
Go around to the back of the wooden container and remove the opposite side



Inside the wooden container we have supplied a metal ramp.



The metal ramp has to be positioned at the **front** of the wooden container.



Fix the metal ramp to the wooden container with screws using a power tool or screw driver.



Once the metal ramp is in place,

Remove the transportation brackets from each side of the TruFade. These are highlighted in the blue rectangle on the picture opposite.



Carefully Wheel the TruFade down the ramp

**PLEASE BE AWARE THIS INSTUMENT WEIGHS 340 kg AND MOST OF THIS WEIGHT IS AT THE TOP.**

**DO NOT ATTEMPT TO ROLL THIS UNIT DOWN THE RAMP ALONE AS IT MAY TOPPLE OVER AND CAUSE INJURY.**



Remove all of the protective wrapping.



The instrument will look like this once unwrapped.



This is the Air Outlet Top

Place the air outlet top in the hole next to the lamp access point,

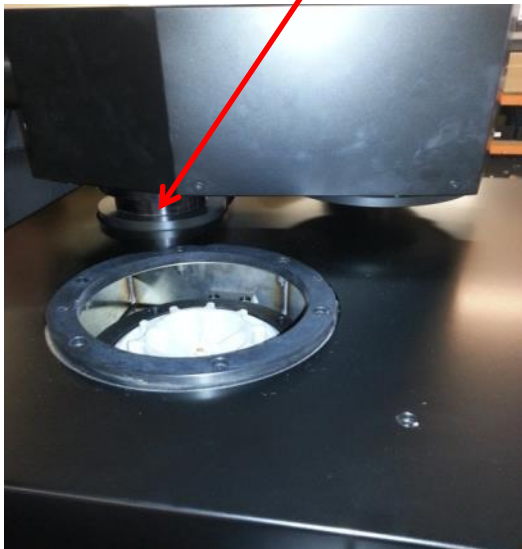

Do this by pushing down





Once the air outlet is attached, swing the lid to the left until it clicks over the lamp access point.



This is how the top should look once assembled



Now attach the skirts to the front of the machine.



And the back



Secure these with a screwdriver

Your TruFade is now successfully unpackaged

# TECHNICAL SPECIFICATION

<b>LIGHT SOURCE</b>	2200W Air-cooled ozone free xenon lamp Adjustable from 1400W to 2200W Cooling: Centrifugal blower 340m <sup>3</sup> /h
<b>IRRADIANCE</b>	SolarSens UV radiometer and BST  300-400nm Sensor: 25.0 to 200.0 W/m <sup>2</sup> Automatic selection via test parameters  Optical filter arrangement utilising KG1 heat absorbing glass.  Automatic prompt when lamp or optical filters require changing.
<b>STANDARDS</b>	10 Fully Programmable standards (including the following pre-programmed standards):  AATCC TM16- 2003 Option 3 ISO 105-B02:1999 – Controlled Irradiance Method ISO 105-B02:1999 – Nominal Power Method M&S C9/C9A:2009 – Controlled Irradiance Method M&S C9/C9A:2009 – Nominal Power Method  Plus 5 user defined.
<b>TEST CHAMBER ENVIRONMENT</b>	Fully automatic setting and control of all test parameters, including: Temperature and humidity, turntable speed, turning mode and irradiance.  Programmable monitoring of test conditions.  Automatic re-start after a power failure and lamp cool-down timer at end of test.
<b>CHAMBER TEMPERATURE</b>	Cooling: Variable speed waterproof centrifugal fan  Variable position air-vane to re-circulate air in chamber to stabilise conditions.  Measurement: Chamber Temperature Sensor 0 to 100°C Readability:0.1°C Accuracy:±0.4°C. Interchangeable sensor.  Black Standard Thermometer (BST) 0 to 100°C. Readability:0.1°C.
<b>CHAMBER HUMIDITY</b>	Humidification: 2 x Ultrasonic transducers, Oscillating @1.6MHz. Mist Output ratio 0 to 950ml/h.  Measurement: Chamber Relative Humidity Sensor.

0 to 100%RH  $\pm$  1.5%RH.  
Readability 0.1%RH Accuracy:  $\pm$  1.5%RH.  
Interchangeable sensor.  
Water consumption: 0.9l/hr max.

#### **TURNTABLE (CAROUSEL)**

9 position platen giving a 1640cm<sup>2</sup> test area.  
Programmable 2 to 7 rpm in 1rpm steps.  
Accuracy: Self tuning speed adjustment.

#### **SPECIMEN EXPOSURE**

9 x Tri-Sided specimen holders (maximum 135 x 45mm each side).  
8 x Programmable test timers for your favourite exposure durations.  
Run continuously setting for manual checking.  
Automatically calculates irradiation dosage.

#### **SOFTWARE**

User configurable Languages:  
English, French, German, Spanish and Italian.  
Data Logger.

#### **SAFETY**

Safety interlock on all access doors.  
Toughened NG4 Neutral density viewing window for safe viewing.  
Built-in self-diagnostics & warnings.

Machine complies CE Directives for machine safety, low voltage and EMC.

Machinery Directive 2006/42/EC  
Low Voltage Directive 2006/95/EC  
EMC Directive 2004/108/EC  
WEEE Directive 2002/96/EC (under review in 2012)  
RoHS Directive 2002/95/EC  
ELECTROMAGNETIC COMPATIBILITY (EMC) DIRECTIVE 2004/108/CE

#### **ELECTRICAL RATING**

3.5KW max. 230V  $\pm$ 15% 50-60Hz.  
Low electrical running cost due to high efficiency PFC lamp power supply.

#### **DIMENSIONS / WEIGHT**

Width:754mm Depth:795mm Height:1610mm  
Weight: 340Kg Dry Weight

#### **AMBIENT CONDITIONS**

20°C and 65%RH recommended

#### **DIAGNOSTICS**

Comprehensive built-in service utilities for James Heal Service and Calibration engineers only

# REVISION HISTORY

See front cover for Publication number, e.g., 290-200-1\$A.

Rev	Date	Originator	Details of revision
A		CT	New release
B	14-02-14	PG	Electrical safety warnings added to pages 8, 29, 30 and 32