



## OPERATOR'S GUIDE

Abrasion Testing of Leather Using the  
Martindale Ball Plate

Covering Serial Numbers  
1001 and upwards

Complies with:

- VDA Test Method 230-211 (June 2008)
- EN ISO 17076-2
- IUP 48-2

James H. Heal & Co. Ltd.  
Halifax, England



Publication 290-1300-3\$A  
© 2012

Setting the Standard

## Abrasion Testing of Leather

### Determination of the Abrasion Resistance of Leather Surfaces using a Martindale Abrasion Tester and Ball Plate

#### Introduction

The Martindale abrasion test procedure documented in VDA 230-211 was developed by members of the VDA in an attempt to improve the correlation between test conditions and real life conditions.

Leather car seats are produced to provide a soft yet tough leather surface which must continue through the life of the car. The tanning process has to soften and strengthen the leather without compromising any of the stringent automotive specifications. During this process, the nature of the animal hide is significantly changed and enhanced, improving its softness, toughness and durability.

With the use of coating technology leather manufacturers can now make the highest quality leathers. Genuine leather comes in many types and qualities and the tanning process can be carried out in various ways according to the intended use of the leather.

The cost of tanning leather for the automotive industry is higher than tanning of leather intended for other purposes. Genuine leather interiors have more direct contact with the human body than other types of leather and it is necessary to consider the long term effects on product and user.

For example, leather steering wheel covers must have a high resistance to abrasion and acid residues from the hands of the driver, while leather seat covers must also have high resistance to heat.

#### Verband der Automobilindustrie (VDA)

The Verband der Automobilindustrie, abbreviated VDA, is a German interest group (association) of the German automobile industry, both automobile manufactures and automobile component suppliers. The group, located in Frankfurt, Germany, was set up by the automobile industry itself.

The VDA publishes a series of standards and recommendations. Among these is the German Quality Management System (QMS) for the automobile industry.

VDA 6 is the European quality standard for suppliers in the European Automotive Industry / German automobile industry (Ford, BMW, Fiat, Volkswagen, Audi, Porsche, SEAT, Opel, Peugeot-Citroën, Renault, Iveco, MAN, Volvo Bus and Daimler).

Suppliers may opt to use the ISO/TS 16949 standard for quality requirements instead of VDA 6.1. ISO 16949 covers the requirements of QS 9000, VDA 6.1, AVSQ, EAQF standards and is accepted as an alternative to these standards by European and other major automotive manufacturers.

## Standards

The Ball Plate complies fully with the requirements of:

- VDA Test Method 230-211 (June 2008)
- EN ISO 17076-2
- IUP 48-2

## Ball Plate Kit

The Ball Plate Kit (794-410) contains the following parts:

<b>Stock code</b>	<b>Description</b>
525-795	Ball Plate Assembly
525-799	Holder Guide Spacer for model 864 (complete with 3 screws)
525-899	Holder Guide Spacer for 900 series (complete with 3 Torx screws)
525-793	Specimen Template (160mm diameter)
201-826	ISO Certificate of Calibration
290-909-3	Operator's Guide (this document)

## Test Materials and Accessories

The following Test Materials are required:

<b>Stock code</b>	<b>Description</b>
714-612	1 x pack (20) Woven Felt Pads (140mm diameter) EN ISO 12947-1 Table 2
786-256	1 x pack (approx. 2400) Pre-cut Discs of Polyetherurethane Foam (38mm diameter) EN ISO 12947-1 Table 3

The following accessories are useful:

<b>Stock code</b>	<b>Description</b>
902-222	1 x Circular Cutter (38mm diameter)
761-801	Cutting Boards for Circular Cutter - per pack (10)
788-761	1 x Lissajous Figure Marker Pen
788-760	Lissajous Figure Recording Paper - per pack (100)

## Fitting the Holder Guide Spacer

Two types of Guide Spacer are supplied. Use the one on the left hand side for the Nu-Martindale model 864 and the one on the right for the Martindale 900 series.



Carry out this procedure with the Top Plate in place on top of the James Heal Martindale. The following example shows the Ball Plate being setup on the Maxi-Martindale 909.



- Using a screwdriver or T20 Torx driver, remove the 3 screws which hold the Bearing Housing in the Top Plate. Store the screws in a safe place.
- Place the Holder Guide Spacer over the 3 screw holes in the Top Plate.
- Replace the Bearing Housing on top of the Holder Guide Spacers with the screw holes aligned.
- Carefully place the 3 long screws through the holes in the Bearing Housing, through the Holder Guide Spacer and tighten gradually.
- When the 3 screws are tightened completely, the position is ready for use.
- Repeat the procedure for any remaining positions which require converting.

### Setting the motion of the James Heal Martindale Abrasion Tester

For an abrasion test, all 3 drive peg units must be in position C, as shown in the figure below, in order to produce the large (60.5mm) Lissajous motion.

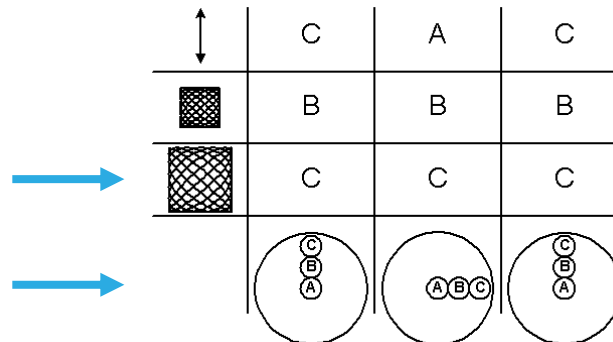

Remove or raise the Top Plate and set the pegs or wheels in position “C”. Leave the Top Plate off or raised until the Ball Plate(s) have been prepared.

### Preparing the specimen

Mark a circular specimen on the sample of leather using the 160mm diameter Specimen Template. Using scissors or a knife, cut out the 160mm diameter specimen from the leather sample.

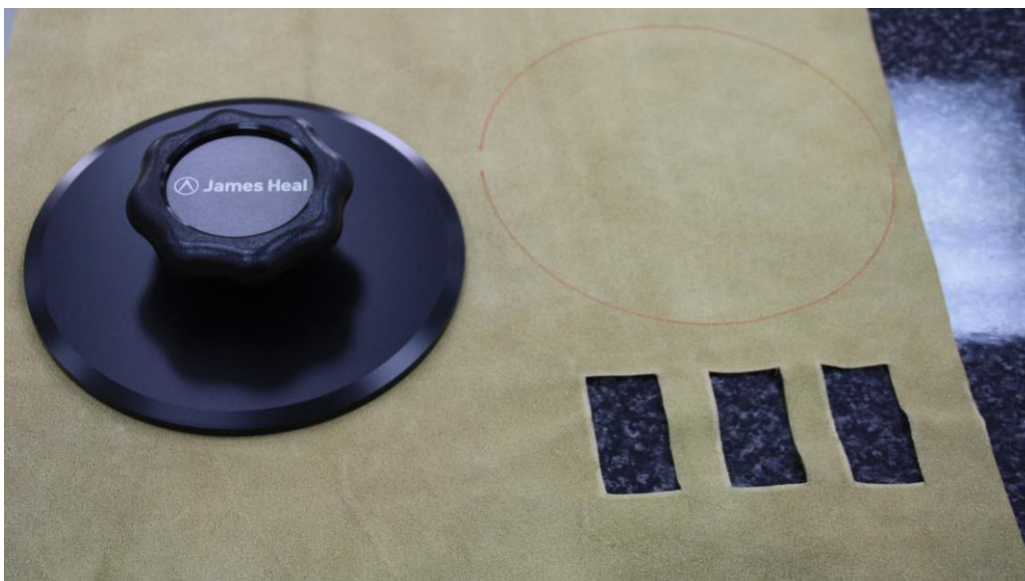

## Setting up the Workstation with Ball Plate and specimen

The empty Abrading Table is loaded in the following order:

1. Empty Abrading Table
2. Woven Felt disc
3. Ball Plate
4. Leather specimen (face up)
5. Pressing Weight
6. Clamp Ring

The Ball Plate should be placed on the abrading table so that the pattern of the balls matches the squares translated by the Lissajous figure.

In order to ensure that there are no creases and that the specimen is correctly tensioned, the pressing weight should be used.



1



2



3



4

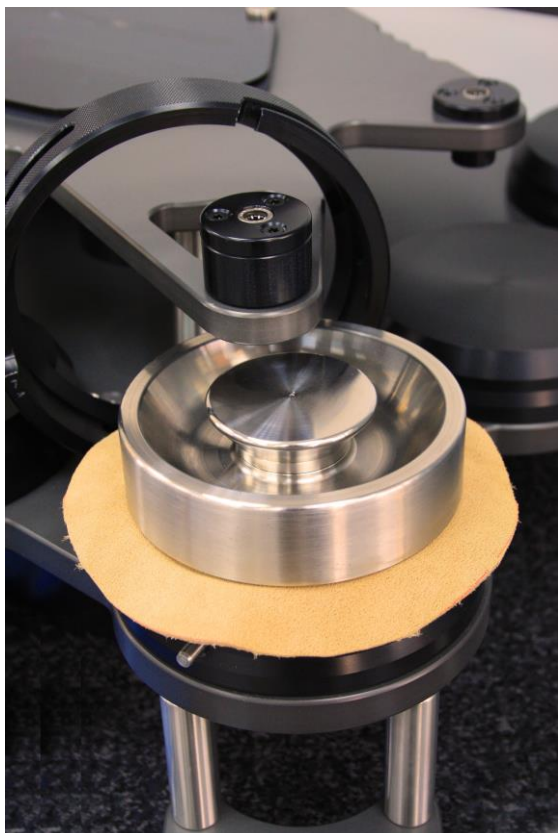

5



6

## Preparing the Abrasive specimen holder

In the case of VDA 230-211, the specimen holder houses the Abrasive Cloth.



Take care when assembling the Abrasive Cloth in the specimen holder.

If the Abrasive Cloth is not fully engaged, it may be partially or completely removed during testing.

If the Abrasive Cloth is removed during testing the consequences could be catastrophic - the specimen could be damaged and, should the specimen also fail and expose the Ball Plate it will bring the Specimen Holder into direct contact with the Ball Plate.

If this event occurs the Ball Plate may become unusable - the balls may be damaged or removed from the plate.

When inspecting the leather specimen, also check the integrity of the abrasive in the specimen holder.

## Test Procedure

A translation of VDA 230-211 is attached.

## Important Notes

The VDA Test Procedure indicates testing using a number of “cycles”. Strictly speaking, according to EN ISO 12947-1, a cycle is equal to 16 rubs. Therefore, when “cycles” is encountered in the VDA text attached, it should be taken as meaning “rubs”.

Use a new piece of Abrasive Cloth and Polyetherurethane Foam for each test.

The test can be carried out dry or wet. When the “wet” test is used, the alkaline perspiration solution is described in EN ISO 105-E04.



**'Abrasion Testing of Leather'**  
**Determination of the Abrasion Resistance of Leather**  
**Surfaces using a Martindale Abrasion Tester and a Ball**  
**Plate**

(This is not an original VDA document)

**Jun-08**  
**VDA**  
**230-211**

## Contents

1. Scope
  2. Instrument and Accessories
  3. Test Specimen
  4. Test Method
    - Loading the Leather Sample
    - Test: Method A (dry)
    - Method B (with perspiration solution)
  - 4.2A Abrasive Cloth (dry)
  - 4.2B Abrasive Cloth (with perspiration solution)
  - 4.3 Testing
  - 4.4 End of Test
  - 4.5 Accuracy
  - 4.6 Identification of Damages
  5. Test Report
- Annex A: Examples of Damages  
Annex B: Drawing of Ball Plate

### 1. Scope

The Test is used to determine the abrasion resistance of leather which is used for car seats. The Martindale Abrasion Tester (specified in EN ISO 12947-1) is used. In order to better simulate *real life* conditions, a Ball Plate is introduced.

## 2. Instrument and Accessories

The abrasion test is carried out on a Heal's Martindale or Nu-Martindale Abrasion Tester (EN ISO 12947-1).

The following accessories are used:

- a) Sample Holder (38 mm diameter specimen)
- b) Pressing Weight
- c) 12 kPa Loading Weight
- d) Abrasive Cloth specified in Table 1 of EN ISO 12947-1 (diameter 38mm)
- e) Woven Felt specified in Table 2 of EN ISO 12947-1
- f) Polyetherurethane Foam specified in Table 3 of EN ISO 12947-1
- g) Ball Plate (Figure 1)
- h) Perspiration solution specified in EN ISO 105-E04
- i) Microscope (x50) – optional – used to aid visual assessment
- j) Container with an inside diameter of 60-63mm
- k) Timing device (e.g., stopwatch)

Figure 1: Ball Plate

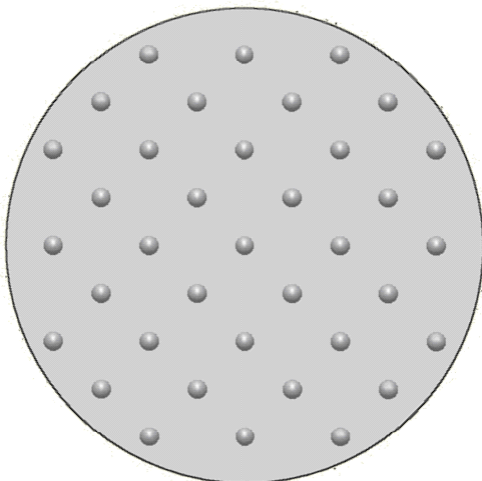
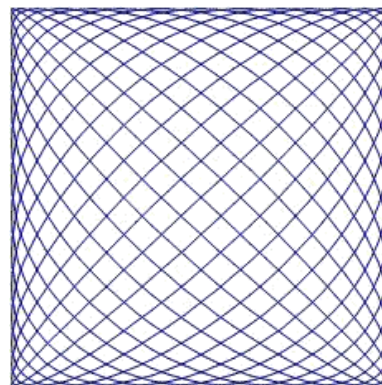

Figure 2: Lissajous Figure



The Lissajous figure is the path which the centre of the specimen holder follows over the surface of the leather specimen.

### Dimensions of the Ball Plate:

Diameter:	120mm
Thickness:	4.5mm
Orientation of Balls:	One ball in centre of plate
Ball diameter:	5mm
Pitch of Balls:	17mm

Please refer to the attached drawing in Annex B.

### **3. Test Specimens**

The test specimens must be conditioned for a minimum of 24 hours in a standard atmosphere (23°C, 50% RH) – see also ISO 2419.

### **4. Test Method**

#### **4.1 Loading of Specimen**

The abrading table is loaded in the following order:  
Woven Felt, Ball Plate, Leather specimen.

In order to ensure that there are no creases and that the specimen is correctly tensioned, the pressing weight should be used.

The Ball Plate should be placed on the abrading table so that the pattern of the balls matches the squares translated by the Lissajous figure – see Figure 2.

#### **4.2 Test Method A (dry) and Test Method B (with perspiration solution)**

In Method A, the abrasive cloth is used in a dry condition.

In Method B, the abrasive cloth is impregnated with perspiration solution.

##### **4.2A Abrasive Cloth (dry)**

The Abrasive Cloth with a foam backing is placed in the sample holder.

##### **4.2B Abrasive Cloth (impregnated with Perspiration Solution)**

Procedure is the same as 4.2A. Finally, the sample holder is soaked for 5 minutes in a vessel containing 2 ml of *alkaline* perspiration solution.

#### **4.3 Testing**

The specimens, under a loading of 12kPa, are abraded. The abrasion tester is adjusted so that it transcribes a large (60.5mm) Lissajous figure (normally used for abrasion rather than pilling tests, which is 24mm).

#### **4.4 End of Test**

The test is ended when four or more ( $\geq 4$ ) damages / breaks in the fibre structure of the leather are visible.

#### **4.5 Accuracy**

The occurrence of damages / breaks after 100 abrasion cycles should be accurately quoted. In order to assess the specimen, the test is stopped and the specimen is visually rated. The machine is then restarted. This procedure is continued until four damages / breaks are visible.

It is sensible to carry out a pre-test (e.g., over 500 abrasion cycles). In this way, the testing time can be significantly reduced.

#### **4.6 Identification of Damages**

In order to accurately identify damages / breaks, a device with a magnification of x50 may be used. This also allows the specimens to be evaluated in situ.

### **5. Test Report**

The test report should indicate the following:

- Any deviation from this method
- Specimen behaviour and details of the specimen
- Specimen pre-treatment
- Result after 100 abrasion cycles
- Number of damages / breaks
- Date of report
- Any other observations or remarks

## Annex A

### Abrasion Testing of Leather

Examples of damages / breaks (photographed under a magnification of x50)

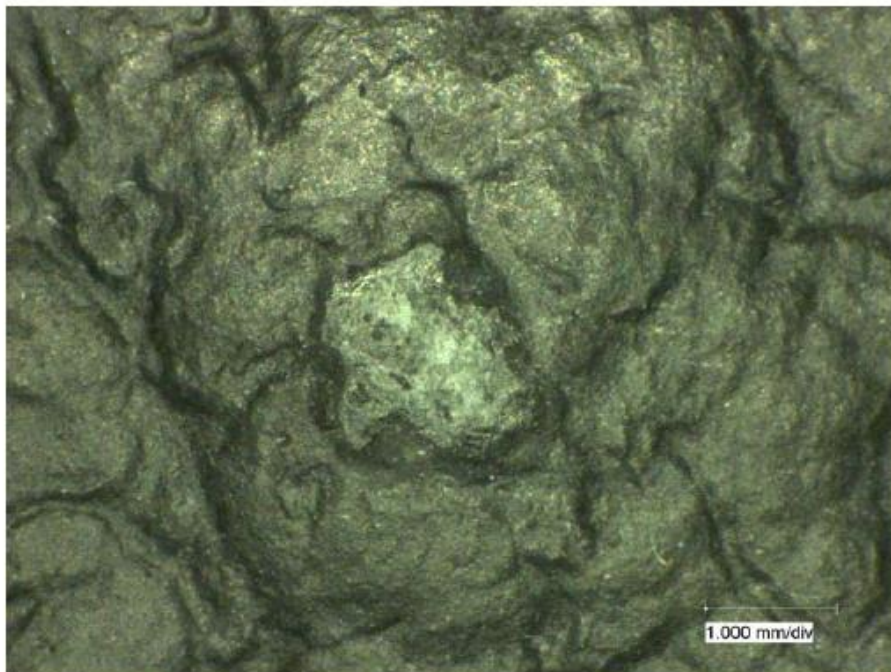
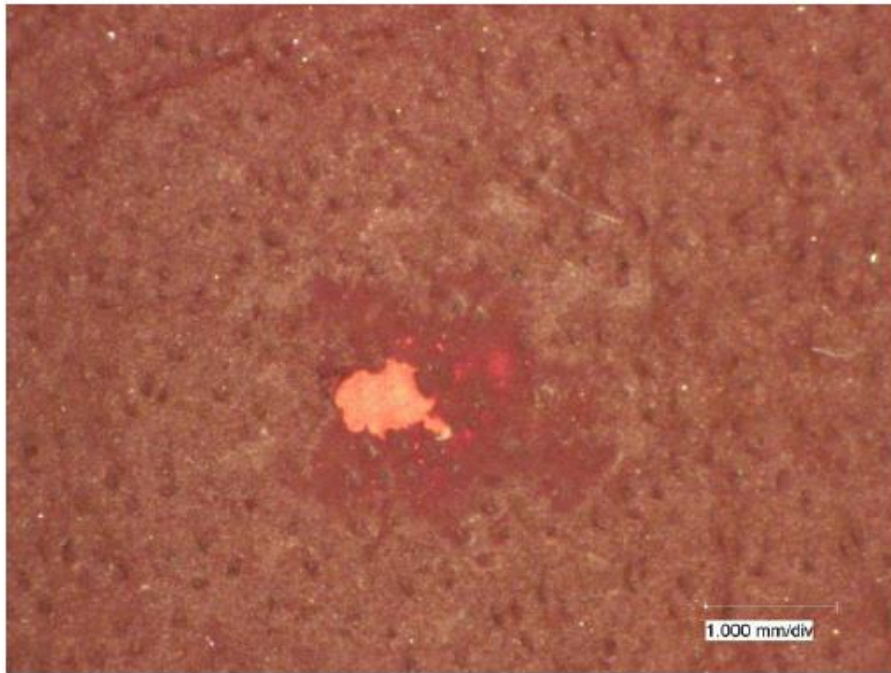

## Annex B

### Abrasion Testing of Leather

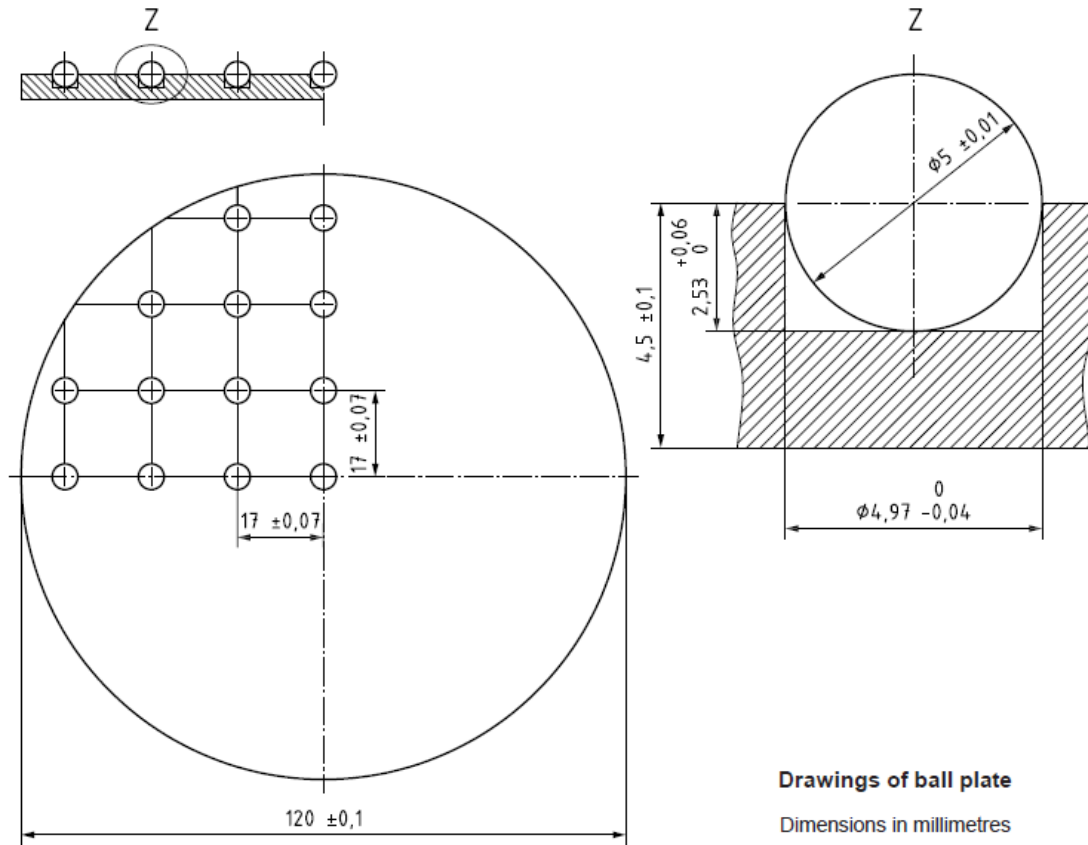

After insertion of the steel balls the plate should be placed between two parallel steel plates and calibrated with a force of 18 kN.

Materials:

Balls – Steel

Base Plate – Steel or Aluminium