



## OPERATOR'S GUIDE

### ThermaPlate

Contact Heat Tester  
Model 1720

Covering Serial Numbers  
1720/17/1001 and upwards

NEW **Intuitive**

**Touchscreen User Interface**

James H. Heal & Co. Ltd.  
Halifax, England

**Setting the Standard**



THE QUEEN'S AWARDS  
FOR ENTERPRISE:  
INTERNATIONAL TRADE  
2012

Publication 290-1720-1\$A  
© 2017

Published by:

JAMES H. HEAL & CO. LTD.  
RICHMOND WORKS  
HALIFAX  
WEST YORKSHIRE  
HX3 6EP  
ENGLAND

TELEPHONE +44 (0) 1422 366355  
FAX +44 (0) 1422 352440

E-mail [info@james-heal.co.uk](mailto:info@james-heal.co.uk)  
Internet <http://www.james-heal.co.uk>

© 2017

# Table of Contents

|  |    |
|--|----|
| James Heal .....                               | 4  |
| Setting the Standard .....                     | 4  |
| Areas of Expertise .....                       | 4  |
| ThermaPlate Contact Heat Tester .....          | 5  |
| Features and Benefits.....                     | 6  |
| Service and Calibration .....                  | 7  |
| Technical Assistance .....                     | 7  |
| Applications .....                             | 7  |
| Standards .....                                | 8  |
| Safety .....                                   | 9  |
| Installation .....                             | 10 |
| Unpacking .....                                | 10 |
| Accessories .....                              | 11 |
| Standard Accessories.....                      | 11 |
| Calibration.....                               | 11 |
| Consumables .....                              | 11 |
| Optional Accessories and Consumables .....     | 12 |
| Operation.....                                 | 13 |
| Connecting to electrical supply .....          | 13 |
| Thermal Protection .....                       | 13 |
| Resetting the Instrument.....                  | 13 |
| Power Saving Feature.....                      | 13 |
| Touchscreen User Interface.....                | 14 |
| Auto Start Mode .....                          | 14 |
| Manual Mode (Auto Start OFF).....              | 17 |
| Performing a Test .....                        | 20 |
| Temperature Warning Indicator .....            | 20 |
| Colour Fastness to Dry Heat .....              | 20 |
| Colour Fastness to Hot Pressing .....          | 21 |
| Thermal Stability .....                        | 22 |
| Maintenance.....                               | 23 |
| Service & Calibration .....                    | 23 |
| ThermaPlate 1720 Technical Specification ..... | 24 |
| Dimensions .....                               | 25 |
| EU Conformity .....                            | 26 |
| Revision History.....                          | 27 |

# JAMES HEAL

At James Heal, we are dedicated to designing and developing high precision testing instruments and test materials for physical and colour fastness testing. Our worldwide service and calibration division and expert technical assistance complement our product range, adding real value to your laboratory testing activities.

## Setting the Standard

We are committed to forming close relationships and have established numerous partnerships within the textile industry, from trade and standards organizations, to test houses, customers and distribution partners.

With a heritage spanning more than 140 years, we have evolved and grown through a culture of continuous improvement, resulting in a thorough understanding of the applications, operating conditions and requirements of customers worldwide - from independent testing laboratories and test houses, to fabric suppliers, manufacturers and retailers.

Using knowledge and expertise, we consistently set the industry standard through product innovation and technology, with customer and user needs, present and future, driving our technological advancements. You can be assured that with James Heal, you will always receive the highest levels of product quality and customer service. We have Agents and Distribution partners all over the globe, ensuring locally available product whenever, and wherever you need it.

## Areas of Expertise

### Textile: Colour Fastness

- Chlorinated Water
- Dry Cleaning
- Dry Heat
- Hot Pressing
- Laundering
- Light
- Perspiration
- Phenolic Yellowing
- Print Durability
- Rubbing
- Washing
- Water

### Textile: Physical

- Abrasion
- Bursting Strength
- Compression and Puncture
- Crease and Wrinkle Recovery
- Crimp
- Drape
- Durability
- Flammability
- Mass per unit area
- Pilling and Fuzzing
- Security of Attachments
- Seam Slippage
- Shrinkage
- Snagging
- Spray Rating
- Stretch and Recovery
- Surface Deterioration
- Tear Strength
- Tensile Strength
- Washing and Drying

### Non-Textile

- Bursting strength of nonwovens, plastics, paper and medical products
- Micro-scratching of laminates, wooden, painted, automotive and high gloss surfaces
- Physical and colour fastness testing of leather
- Rubbing fastness of laminates and wooden surfaces
- Tear strength of paper and plastics

# THERMAPLATE CONTACT HEAT TESTER



## Features and Benefits

- NEW Intuitive Touchscreen User interface.
- Efficient temperature control - allows for the simultaneous heating of both plates, or the top plate only.
- Temperature range of 20°C to 220°C.
- Continuous display of the live and set (target) temperature.
- Accurate timing - countdown timer can be set from 1 second to 59 minutes 59 seconds.
- Test can be started with a choice of 2 options - manual mode or auto-start.
- Manual mode - test can be started at any point once the test is set up by pressing the start button.
- Auto-start - once the test is set up and at temperature, the test will start when the lid is closed.
- Space efficient - occupies only a small area of bench.
- Easy calibration - lid designed to facilitate calibration, optional temperature checking device and fully traceable certification (ISO/IEC 17025 compliant) available.
- Operator safety - positive park position for lid, cool exterior surfaces and warning light which illuminates when plate temperatures exceed 60°C.
- Power save feature - heaters go off after 2 hours of inactivity.
- Standards - compliant with all relevant International, European, American and Retailers standards / methods.
- Insulating plate and specimen platform supplied as standard.
- Test Materials - comprehensive range of standards specific test materials available; multifibre, grey scales, as well as felt and cotton limbric cut to size in order to achieve the correct operating pressure of 4kPa ± 1kPa.

## Service and Calibration

- Worldwide Service
- ISO 17025 based Accredited Calibration and Service
- 18 Months' Warranty

## Technical Assistance

- Operator Training
- Knowledge transfer
- Applications Support
- Engineering Support

## Applications

- Colour fastness to dry heat - Used mainly by fabric producers and dyers & finishers to predict colour changes on dyed and printed fabrics, during subsequent heat treatments.
- Sublimation fastness - Used by polyester producers to select disperse dyes with sublimation characteristics to match their product and process.
- Colour fastness to hot pressing - Used mainly by fabric producers, dyers & finishers and garment makers to determine the resistance of the colour of textiles to change and transfer, when subjected to ironing and to processing on hot cylinders. Tests may be carried out on dry, wet and/or damp specimens.
- Thermal stability - Used by fabric producers, dyers and finishers and garment makers to predict the shrinkage during heat setting synthetic fabrics and particularly those which will be fused together during making up.

# STANDARDS



| ISO  | AATCC   | M&S                                     |
|--|---|---|
| ISO 105-PO1 Colour fastness to dry heat (excluding pressing) * | AATCC 117 Colorfastness to heat: Dry (excluding pressing) | M&S P010 Thermal stability              |
| ISO 105-X11 Colour fastness to hot pressing ^                  | AATCC 133 Colorfastness to heat: Hot pressing             | M&S C13 Colour fastness to hot pressing |



| Adidas                                  | JIS  | GB  |
|---|--|---|
| Adidas 5.09 Colour migration of fabrics | JIS L 0879 Test methods for colour fastness to dry heat<br>JIS L 0850 Test methods for colour fastness to hot pressing | GB 5718 Colour fastness to dry heat (excluding pressing)<br>GB 6152 Colour fastness to hot pressing |

| LOCATION      | 105-PO1*     | 105-X11 ^    |
|---------------|--------------|--------------|
|               | PREFIX       |              |
| AUSTRIA       | ONORM EN ISO | ONORM EN ISO |
| BELGIUM       | NBN EN ISO   | NBN EN ISO   |
| BRITAIN       | BS EN ISO    | BS EN ISO    |
| DENMARK       | DS EN ISO    | DS EN ISO    |
| EUROPE        | EN ISO       | EN ISO       |
| FRANCE        | NF EN ISO    | NF EN ISO    |
| GERMANY       | DIN EN ISO   | DIN EN ISO   |
| INTERNATIONAL | ISO          | ISO          |
| IRELAND       | n/a          | I.S. EN ISO  |
| ITALY         | UNI EN ISO   | UNI EN ISO   |
| KOREA         | n/a          | KS K ISO     |
| NETHERLANDS   | NEN EN ISO   | NEN EN ISO   |
| NORWAY        | NS EN ISO    | NS EN ISO    |
| POLAND        | PN EN ISO    | PN EN ISO    |
| RUSSIA        | GOST R ISO   | n/a          |
| SOUTH AFRICA  | n/a          | SANS         |
| SPAIN         | UNE EN ISO   | UNE EN ISO   |
| SWEDEN        | SS EN ISO    | SS EN ISO    |
| SWITZERLAND   | SN EN ISO    | SN EN ISO    |

ThermaPlate is approved by Marks & Spencer.

\*In order to achieve 4 kPa, specimens & adjacent fabrics with dimensions 10 cm x 10 cm are used. This is also applicable to Adidas.

^In order to achieve 4 kPa, appropriately sized test materials are available from James Heal.



# SAFETY

Read this manual thoroughly before operating the unit.

- Keep clear of the heater plates while the instrument is in use and after the instrument has been turned off. A warning light on the instrument fascia will illuminate when the heater plates are above 60°C, providing the machine is turned on. After use, close the lid covering any exposed hot surfaces and allow the instrument to cool down slowly. Note: the heater plates takes approximately 2 hours to cool down from 220°C to 60°C with the fan running.
- Open the lid using only the attached handle. Avoid touching the metal case.
- It is possible, if a specimen is left in the instrument for longer than the stated length of time or at a higher temperature than that required by the test method, for the specimen to scorch or even ignite. The heater plates are capable of generating temperatures up to 220°C. As a precaution it is recommend that a suitable fire extinguisher, i.e., dry powder is readily available.
- Do not accelerate cooling of the instrument, other than by using the fan. Allow the instrument to cool slowly by radiating heat to the atmosphere.
- The instrument is suitable for wet testing of fabric; however, water should not be poured directly onto the instrument. Water or other liquids should be added to the specimen before it is placed on the instrument.
- The instrument weighs approximately 15.9 kg. Only attempt to lift the instrument if you feel it is within your ability or preferably ask a colleague for assistance.
- ThermaPlate complies with the EU regulations in full.
- Covers should not be removed other than by a qualified engineer, in which case ensure the machine is isolated from the electrical supply before removing any covers.
- Fuses of the correct type and with the correct amperage rating must be used.
- Never use ThermaPlate for anything other than what it is designed for.

# INSTALLATION

## Unpacking

Do not dispose of any packaging material until the order has been checked.

Cut the plastic strapping with scissors. We recommend wearing goggles and gloves to avoid damage to the eyes and hands. Remove the packing tape.

Lift out the accessories box. Remove the tape and ensure that the contents are correct as per your order. Report any anomalies immediately.

Using both hands, remove the cardboard layer from the lower section to reveal the instrument below. The instrument weighs approximately 15.9 kg. Only attempt to lift the instrument if you feel it is within your ability or preferably ask a colleague for assistance. Grasp ThermaPlate by the front and back and lift out carefully.

Stand the instrument on a firm, level surface such as a bench or table. This should be situated in the environment as recommended by the chosen test method.

Unwrap ThermaPlate and remove the paper insert from between the plates.

Level the instrument using the levelling feet - these can be adjusted by rotating them.

Important: position the instrument so that the cooling fan at the rear of the instrument is not obstructed. Ensure the air intake duct underneath the instrument is not restricted.

A conditioned environment will be required once the testing is complete.

# Accessories

## Standard Accessories

|         |  |
|---------|--|
| 906-604 | <b>ThermaPlate model 1720 230V 50/60HZ</b><br>Standard accessories:<br>1 x Specimen Platform 794-827<br>1 x Insulating Board 794-826 |
| 906-605 | <b>ThermaPlate model 1720 110V 50/60HZ</b><br>Standard accessories:<br>1 x Specimen Platform 794-827<br>1 x Insulating Board 794-826 |
| 297-029 | CD Operator's Guide  |

## Calibration

|         |   |
|---------|---|
| 201-620 | ISO Certificate of Calibration for Contact Heat Tester  |
| 794-903 | Temperature Measuring Kit (supplied with UKAS Certificate of Calibration)<br><br>The Temperature Measurement Kit comprises a digital thermometer and probes. It is mandatory for M & S testing. Otherwise, it is a valuable tool for checking the calibration of ThermaPlate. |

## Consumables

|         |   |
|---------|---|
|         | <a href="#">ISO 105-P01, JIS L 0879, GB 5718</a>      |
| 702-500 | Multifibre Adjacent Fabric DW - per roll (10m)        |
| 766-200 | Grey Scale for assessing Change in Colour ISO 105 A02 |
| 766-201 | Grey Scale for assessing Staining ISO 105 A03         |
|         | <a href="#">ISO 105-X11, JIS L 0850, GB 6152</a>      |
| 702-447 | Woven Felt 125 x 90 mm - per pack (10)                |
| 702-446 | Cotton Limbric 125 x 90 mm - per pack (20)            |
| 766-200 | Grey Scale for assessing Change in Colour ISO 105 A02 |
| 766-201 | Grey Scale for assessing Staining ISO 105 A03         |
|         | <a href="#">M &amp; S P010</a>                        |
| 772-133 | Ruler 300 mm/12 in                                    |
|         | <a href="#">M &amp; S C13</a>                         |
| 766-200 | Grey Scale for assessing Change in Colour ISO 105 A02 |

### [AATCC 117](#)

- 702-403 Multifiber Adjacent Fabric Style 10A - per pack (1m)
- 766-512 AATCC Gray Scale for Color Change
- 766-513 AATCC Gray Scale for Staining

### [AATCC 133](#)

- 702-447 Woven Felt 125 x 90 mm - per pack (10)
- 702-446 Cotton Limbric 125 x 90 mm - per pack (20)
- 766-512 AATCC Gray Scale for Color Change
- 766-513 AATCC Gray Scale for Staining

## Optional Accessories and Consumables

- 766-510 **AATCC Chromatic Transference Scale**  
This is a *9-step* scale to evaluate colour transfer or staining.  
It is designed to facilitate evaluation by inexperienced personnel.

- 708-102 **D65<sup>2</sup>FUV/HM** 230V 50/60Hz
- 708-081 **D65TL84CWFUV/HM** 230V 50/60Hz

- 702-502 Multifibre Adjacent Fabric DW - per roll (50m)
- 702-503 Multifibre Adjacent Fabric DW - per roll (100m)

- 702-448 **Wool Adjacent Fabric** - per pack (1m) approx. 123cm wide  
ISO 105-F01

Apart from the Wool Adjacent Fabric, the Single Fibre Adjacent Fabrics, listed below, are manufactured, by a third party, in accordance with the ISO 105 F Series Standard indicated against each fabric. However there may be occasional minor deviations in mass, whiteness or pH from the specifications quoted in the corresponding standard.  
*Please consider this information and only place an order if you accept it.*

- 702-444 **Cotton Limbric Adjacent Fabric** - per pack (1m) approx. 102cm wide  
ISO 105-F02
- 702-440 **Polyester Adjacent Fabric** - per pack (1m) approx. 102cm wide  
ISO 105-F04
- 702-471 **Polyester Adjacent Fabric** - per roll (10m) approx. 102cm wide  
ISO 105-F04
- 702-442 **Polyamide Adjacent Fabric** - per pack (1m) approx. 98cm wide  
ISO 105-F03
- 702-459 **Polyamide Adjacent Fabric** - per roll (10m) approx. 98cm wide  
ISO 105-F03
- 702-393 **Silk Adjacent Fabric** - per pack (1m) approx. 750 mm wide  
ISO 105-F06

## OPERATION

Before operating ThermaPlate please read and follow the safety instructions.

### Connecting to electrical supply

Connect to mains electricity with the lead provided and switch on.

#### **IMPORTANT: THIS INSTRUMENT MUST BE EARTHED**

This instrument is available for use with mains voltage of either 240V 50Hz/60Hz or 110V 50/60Hz. The mains inlet and fuse holders are located at the rear of the instrument. The mains lead wires are coloured in accordance with the following code:

|              |         |
|--------------|---------|
| Green/Yellow | Earth   |
| Blue         | Neutral |
| Brown        | Live    |

### Thermal Protection

Should the internal compartment of the instrument base overheat, a thermal trip (cut-out) will activate, preventing damage to the instrument. This may occur if the cooling fan fails or if cooling air is restricted from entering / exhausting from the instrument. Activation of the thermal trip will be noticeable by the heater plates failing to maintain temperature. Should this occur, turn the heaters off and allow the instrument to cool down. Check the cooling fan is operating correctly.

### Resetting the Instrument

The thermal trip will reset automatically once the temperature inside the instrument base compartment has fallen to the correct operating temperature. Resetting is automatic and requires no intervention from the operator.

### Power Saving Feature

The heaters will turn off after 2 hours of inactivity.

# TOUCHSCREEN USER INTERFACE

## Auto Start Mode

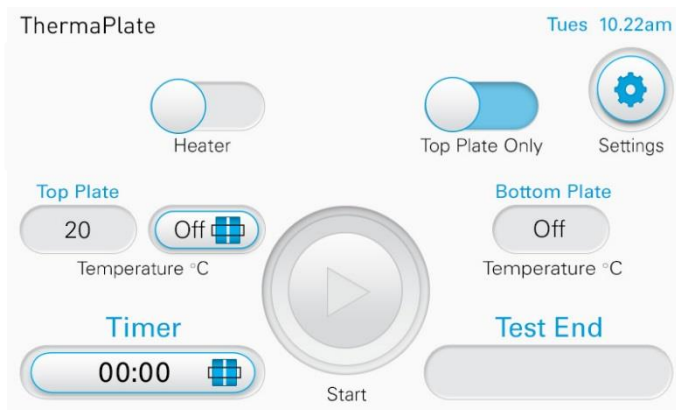

ThermaPlate Home Screen

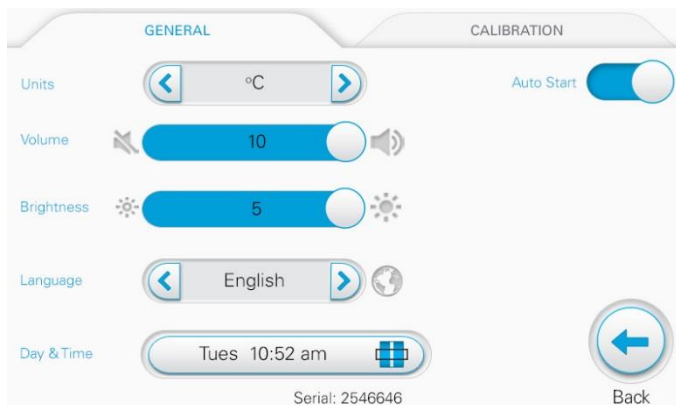

### Auto Start On

Auto Start can be activated from the GENERAL screen in Settings.

Once Auto Start has been selected, the test can be started automatically by closing the lid of ThermaPlate once the timer has been set and the plates have reached the set temperature.

The following can also be changed in general settings:

- Temperature Units - °C or °F
- Volume
- Brightness
- Languages - English, French, German, Spanish Italian, Turkish, Chinese, Hindi
- Day and time

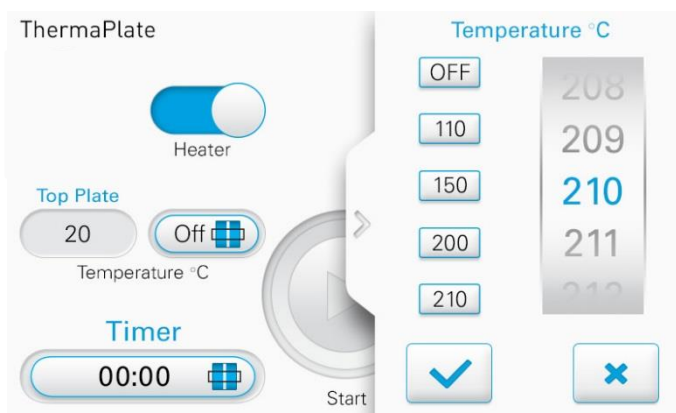

### Setting the Temperature

To set the temperature, press on the temperature button scroll wheel, this brings out the set up tab. Select the required temperature and press the tick button. The heater will toggle on. Alternatively, select a pre-set value. To save a new value, select the required temperature in the scroll wheel, then press and hold the chosen preset button.

If the heater is toggled on first, the heater scroll set up tab will appear.

Once the heater is on and the temperature is set, ThermaPlate will start to heat up the plate/s to the set temperature.

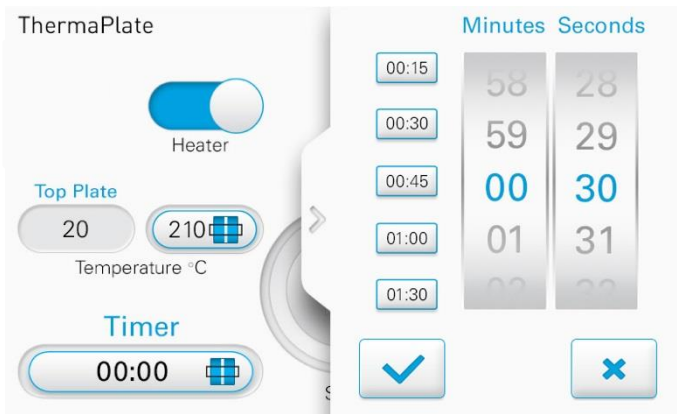

### Setting the Timer

To set the timer, press the timer button and the scroll wheel set up tab will appear. Set the required time and then press the tick. The maximum time that can be set is 59:59.

Alternatively, select a pre-set value. To save a new value, select the required time in the scroll wheels, then press and hold the chosen preset button.

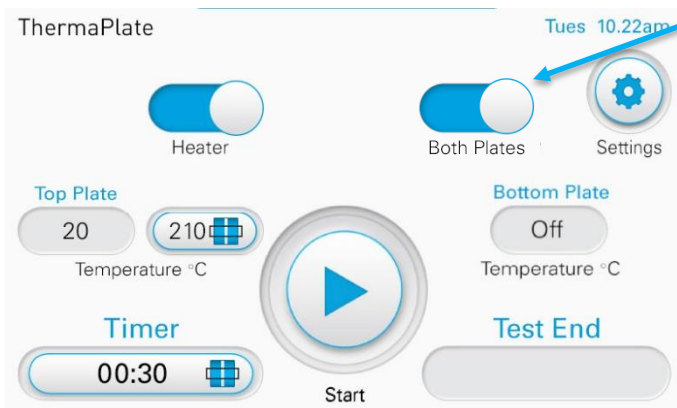

### Plate Options

To select either 'Top Plate Only' or 'Both Plates,' slide the toggle switch left and right.

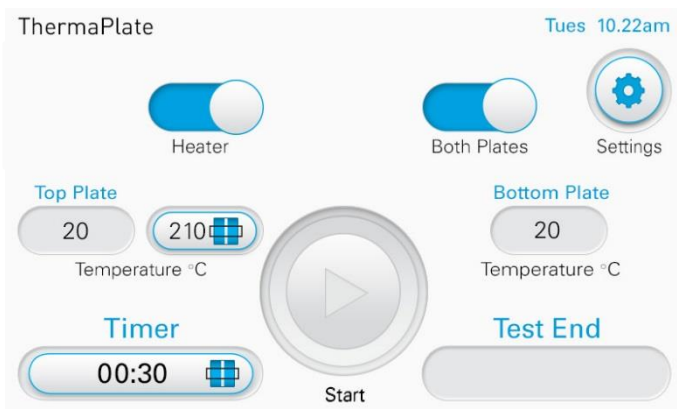

### Test Generated

Once the temperature and time have been selected, wait for the plate/s to reach the chosen temperature.

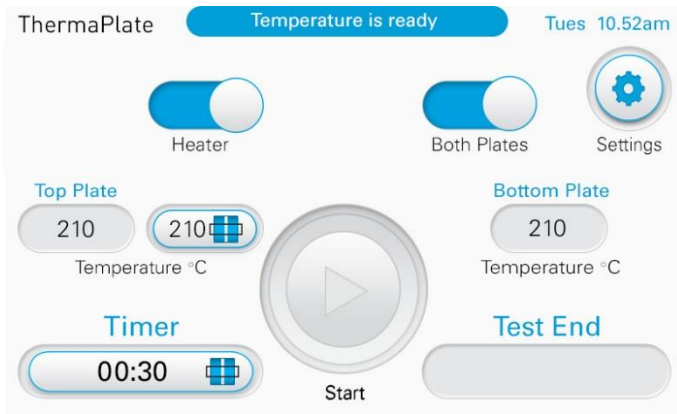

### Temperature Ready

Once the plates have reached the set temperature in the display window/s, a box will appear to notify that the temperature is ready.

The specimen can now be added to ThermaPlate.

The timer will start automatically, once the ThermaPlate lid is closed.

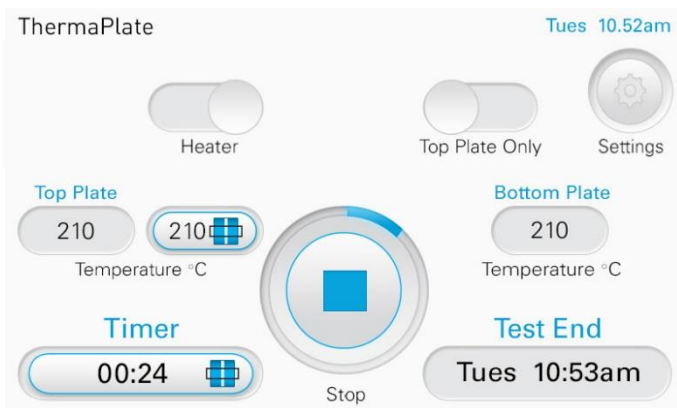

### Test in Progress

Whilst the test is running:

- The Test End will display the time that the test will complete
- The Timer will count down
- The progress ring will display the progress of the test
- The buttons and toggle switches will be inactive and greyed out

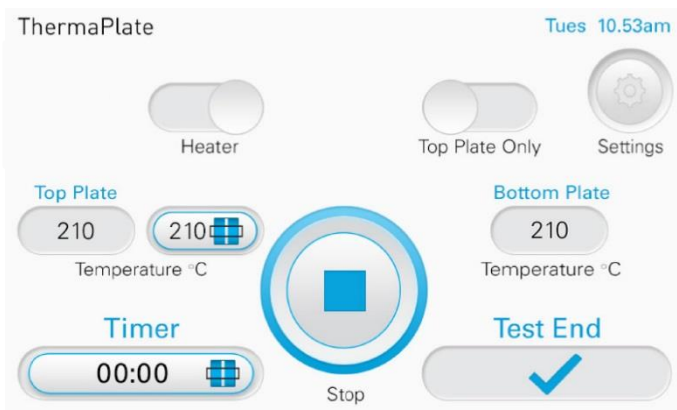

### Test End

Once the test is complete:

- Test End display will show a tick
- The Timer will display 00:00
- The progress ring will be complete
- The end chime will cycle until Stop is pressed, or the lid is opened

Once the test has been stopped, the buttons and toggle switches will be live once again.



# Manual Mode (Auto Start OFF)

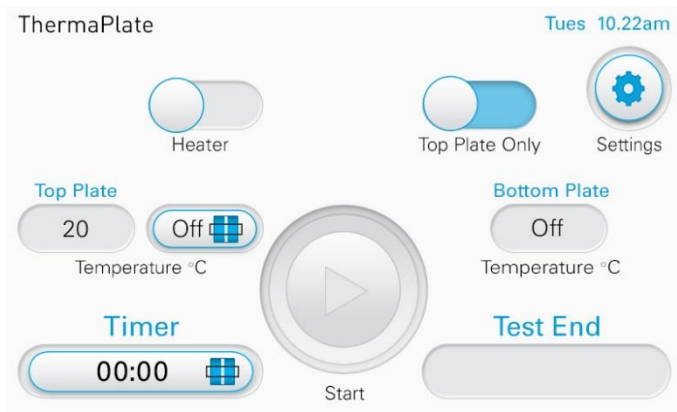

ThermaPlate Home Screen



## Auto Start Off

Auto Start can be toggled off (to the left) in the GENERAL screen in Settings.

Once Auto Start is off, the test can be started with the Start button once the timer and temperature have been set.

The following can also be changed in general settings:

- Temperature Units - °C or °F
- Volume
- Brightness
- Languages - English, French, German, Spanish Italian, Turkish, Chinese, Hindi
- Day and time

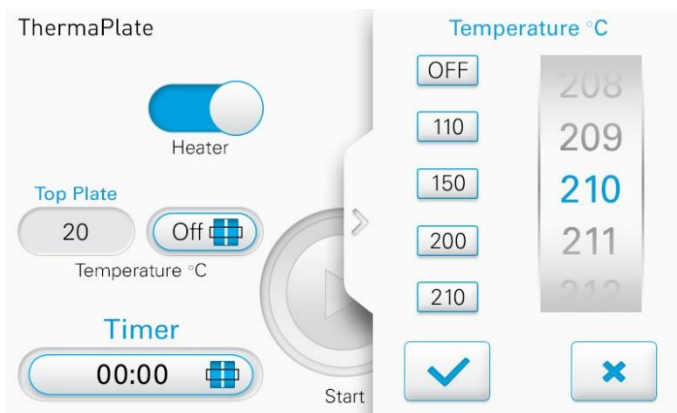

## Setting the Temperature

To set the temperature, press on the temperature button scroll wheel, this brings out the set up tab. Select the required temperature and press the tick button. The heater will toggle on. Alternatively, select a pre-set value. To save a new value, select the required temperature in the scroll wheel, then press and hold the chosen preset button.

If the heater is toggled on first, the heater scroll set up tab will appear.

Once the heater is toggled on and the temperature is set, ThermaPlate will start to heat up the plate/s to the set temperature.



### Setting the Timer

To set the timer, press the timer button and the scroll wheel set up tab will appear. Set the required time and then press the tick. The maximum time that can be set is 59:59.

Alternatively, select a pre-set value. To save a new value, select the required time in the scroll wheels, then press and hold the chosen preset button.

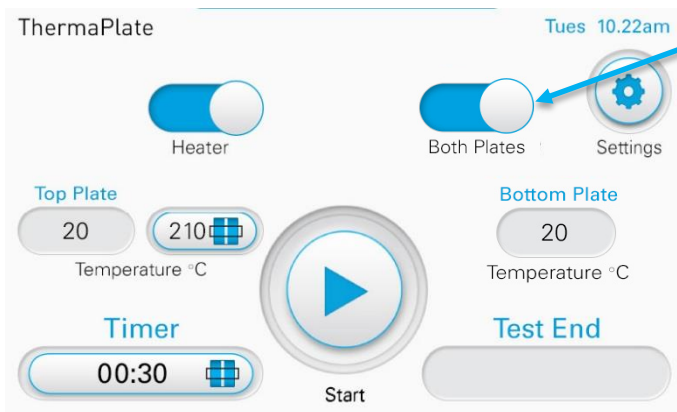

### Plate Options

To select either 'Top Plate Only' or 'Both Plates,' slide the toggle switch left and right.

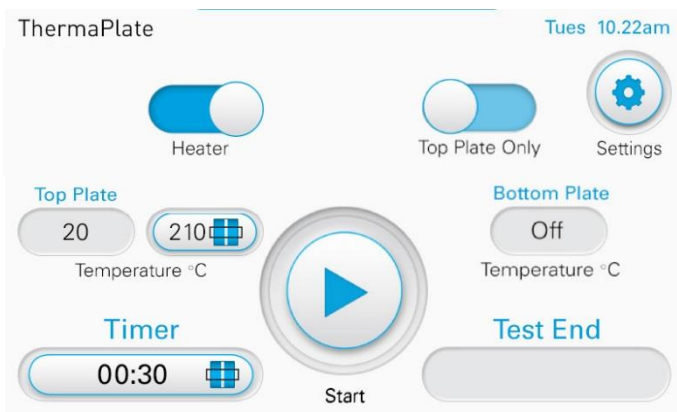

### Test Generated

Once the temperature and time have been selected, wait for the plate/s to reach the chosen temperature.

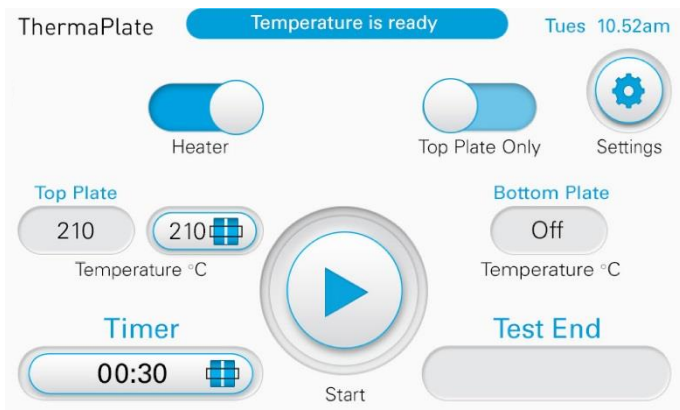

### Temperature Ready

Once the plates have reached the set temperature in the display window/s, a box will appear to notify that the temperature is ready.

The specimen can now be added to ThermaPlate.

Start the test by pressing the start button.

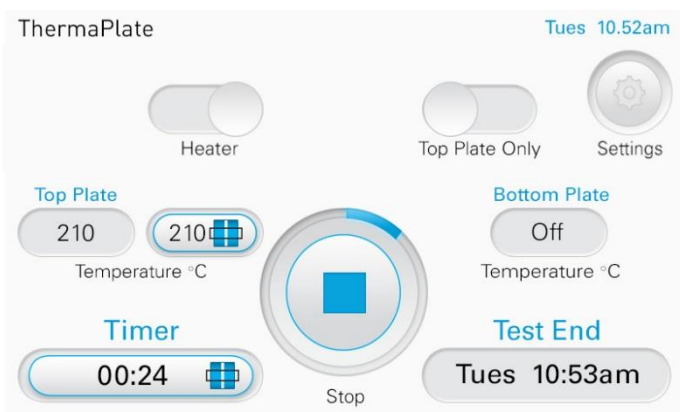

### Test in Progress

Whilst the test is running:

- Test End will display the time that the test will complete
- The Timer will count down
- The progress ring will display the progress of the test
- The buttons and toggle switches will be inactive and greyed out

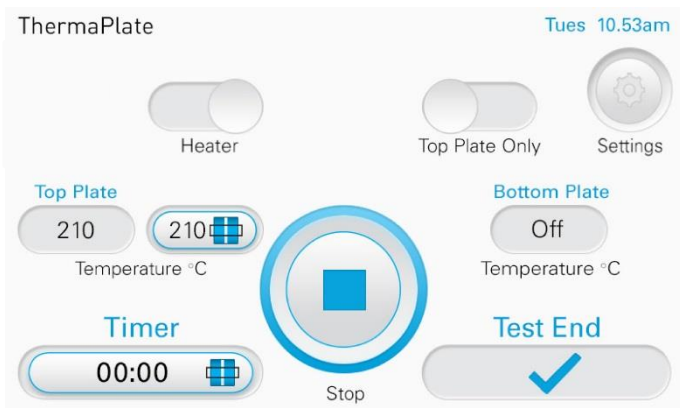

### Test End

Once the test is complete:

- Test End display will show a tick
- The Timer will display 00:00
- The progress ring will be complete
- The end chime will cycle until Stop is pressed, or the lid is opened

Once the test has stopped, the buttons and toggle switches will be live once again.

## PERFORMING A TEST

Before use, when the instrument is cold, inspect the top and bottom plates for damage and debris. Clean if necessary as described in Maintenance.

Set the plates to the temperature required in the standard. Upon reaching the required temperature allow the machine to stabilise for 10 minutes, unless the standard specifies a longer period of stabilisation in which case this should be followed.

A non-conducting / insulated tool may be used to remove the hot specimens, e.g. glass rod.

### *Temperature Warning Indicator*

The temperature warning indicator on the front of the instrument will illuminate when the top and/or bottom hot plates exceed 60°C, warning that they are no longer safe to touch. Only when both plates have cooled below 60°C will this indicator go out.



The following test methods are illustrations of suitable applications. Examples are illustrated below but please refer to latest version of the chosen standard for specific instructions on specimen preparation, sizes, temperatures and times.

## Colour Fastness to Dry Heat



- Set the timer to the required end point.
- Set both plates to the required temperature and allow to stabilise.
- Place the composite specimen (10cm x 10cm) on the bottom plate and lower the lid. This will receive the required pressure of 4kPa  $\pm$  1kPa.
- If set to auto-start, the timer will start immediately.
- If set to manual mode, press the start button immediately and the timer will start.
- At the end of the test, open the lid and slide the specimen onto the platform using a non-conducting tool.
- Separate the individual layers, place in the conditioned atmosphere and follow the grading procedure as stated in the standard.

## Colour Fastness to Hot Pressing

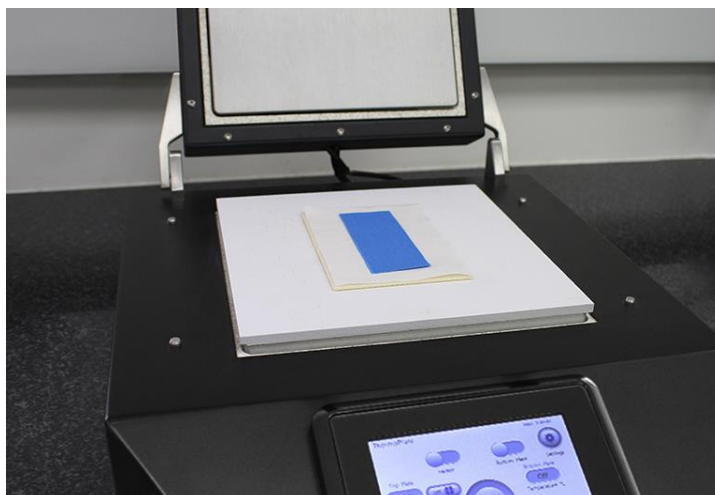

- Set the timer to the required end point.
- The heat on the specimen is only administered from the top plate - set the top plate to the chosen temperature and allow to stabilise.
- Place the heat resistant tile over the bottom plate.
- Place a piece of felt padding onto the tile. The felt should be pre-cut to a size which provides the required pressure ( $4\text{kPa} \pm 1\text{kPa}$ ) onto the sample.
- Place a piece of cotton limbric of the same dimensions as the felt padding over the felt.
- On top of this, place the test specimen (wet or dry) in the centre.
- If required, place an adjacent fabric (e.g., Multifibre, Cotton Limbric) of the same dimensions as the test sample over the test sample (wet\* or dry).
- Lower the top plate.
- If set to auto-start, the timer will start immediately.
- If set to manual mode, press the start button immediately and the timer will start.
- Once the timer has finished, open the lid and remove the composite specimen carefully with a non-conducting tool by sliding onto the specimen platform.
- Separate the individual layers, place in the conditioned atmosphere and follow the grading procedure stated in the standard.

\*Some standards require damp or wet pressing in which case the adjacent fabric and /or test sample may need to be wet out prior to pressing. In these cases, the piece is weighed whilst dry, wet out and reweighed. The correct amount of water pick up can then be calculated. i.e. 100%.

# Thermal Stability



- Prepare a test specimen 200mm X 200mm and mark centrally A-B and C-D.
- Condition for a minimum of 4 hours.
- Measure e.g. A to B = 200mm, C to D = 198mm.
- Set ThermoPlate to the required temperature and allow to heat up and stabilise.
- Set the duration of the test.
- Once stabilised, raise the top plate and position the specimen centrally.
- Lower the top plate.
- Press start if in manual mode.
- If set to auto-start, the timer will start immediately.
- Once the timer has finished, open the top plate and remove the specimen carefully with a non-conducting tool by sliding onto the specimen platform.
- Return to the standard testing atmosphere and allowed to relax on a flat surface - do not use a wire mesh tray.
- Assess the appearance.
- Re-measured the specimens and calculate the percentage elongation or shrinkage:

$$\frac{\text{Initial measurement} - \text{end measurement}}{\text{Initial measurement}} \times 100 = \text{change in \%}$$

E.g.

|        | Initial | End | Change (%)       |
|--------|---------|-----|------------------|
| A to B | 200     | 198 | 1.00 % shrinkage |
| C to D | 198     | 195 | 1.50 % shrinkage |

$$\frac{200 - 198}{200} \times 100 = 1.00 \%$$



## MAINTENANCE

Between service and calibration visits no regular maintenance is required; simply keep the instrument clean and free from dust and debris.

Periodical verification checks of the temperature can be carried out using the thermocouple available from James Heal.



Clean the heater plates when cold only, using a mild detergent on a damp cloth to remove contamination. DO NOT use abrasive cleaners, as these will permanently damage the surface coating.

Periodically check the cooling fan is working correctly and ensure the air intake duct in the base of the instrument is unrestricted. If air duct appears to be blocked, disconnect the instrument from the mains and clear the holes using a suitable vacuum nozzle.

DO NOT probe any objects through the holes to clear any blockage.

## Service & Calibration

James Heal Service & Calibration is a totally comprehensive, worldwide support programme. When you buy instrumentation for us, it is the beginning rather than the end of an association. Our aim is simple, to provide precisely the services you need to maintain and protect the value of your investment.

For any enquiries you may have regarding your instrument please contact the James Heal Service & Calibration Support Team by email or phone.

In all communications please quote the serial number, located of your instrument, for example 620/03/1001.

Email [support@james-heal.co.uk](mailto:support@james-heal.co.uk)

Telephone +44 (0)1442 366355

# THERMAPLATE 1720 TECHNICAL SPECIFICATION

---

|                             |  |
|-----------------------------|--|
| <b>Standards</b>            | AATCC 117, AATCC 133<br>adidas 5.09<br>ISO 105-P01, ISO 105-X11<br>M&S P010, M&S C13<br>JIS L 0879, JIS L 0850<br>GB 5718, GB 6152 |
| <b>Temperature Range</b>    | 20°C to 220°C (68°F to 428°F)  |
| <b>Temperature Units</b>    | °C or °F   |
| <b>Temperature Accuracy</b> | ± 1°C  |
| <b>Timer Range</b>          | 1s to 59min 59s  |
| <b>Languages</b>            | English, French, German, Spanish,<br>Italian, Turkish, Chinese, Hindi  |
| <b>User Interface</b>       | Touchscreen User Interface   |
| <b>Hot Plates</b>           | 210 x 210 mm, top plate 4 kg   |
| <b>Specimen Thickness</b>   | 15 mm (max)  |
| <b>Weight</b>               | 15.9 kg  |
| <b>Dimensions (Open)</b>    | 360 x 590 x 436 mm ( W x D x H)  |
| <b>Safety</b>               | Over-temperature thermostats   |
| <b>Power</b>                | 230V ±10%, 1P+N+E, 50/60Hz, 890W 5A<br>110V ±10%, 1P+N+E, 50/60Hz, 890W 10A  |
| <b>Energy Saving</b>        | Power save feature automatically turns the heaters off<br>after 2 hours of inactivity  |

---



# Dimensions

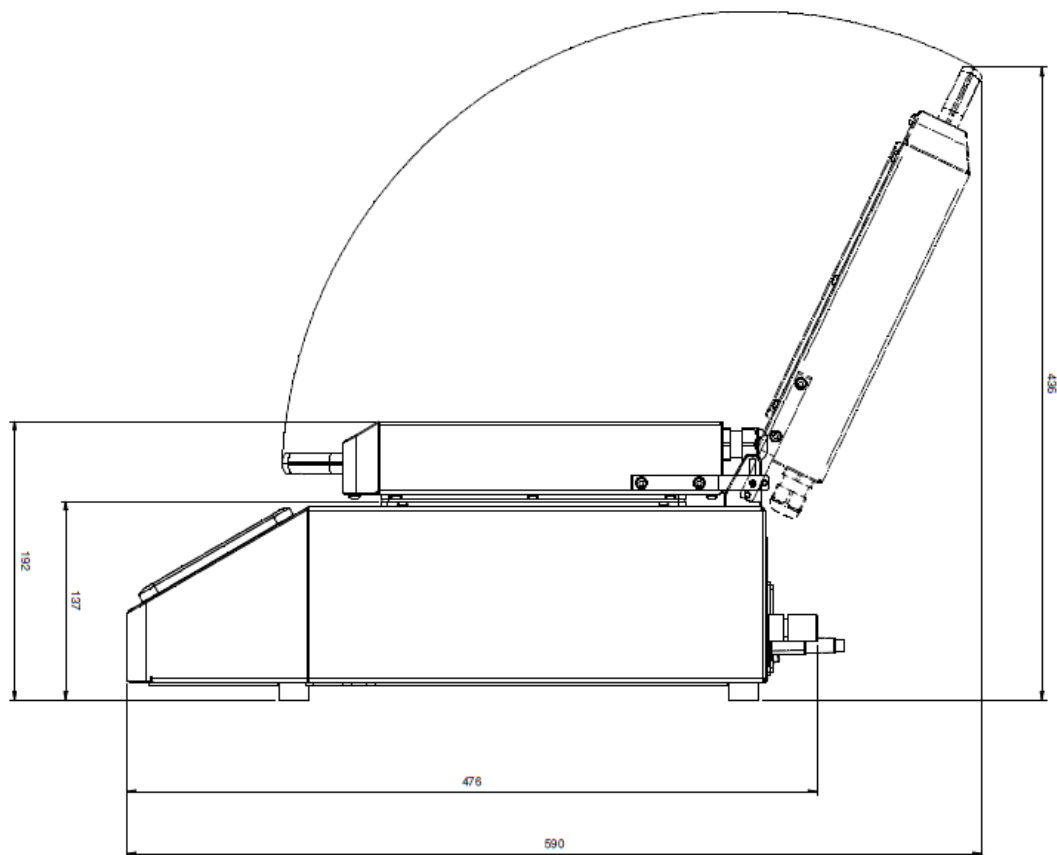
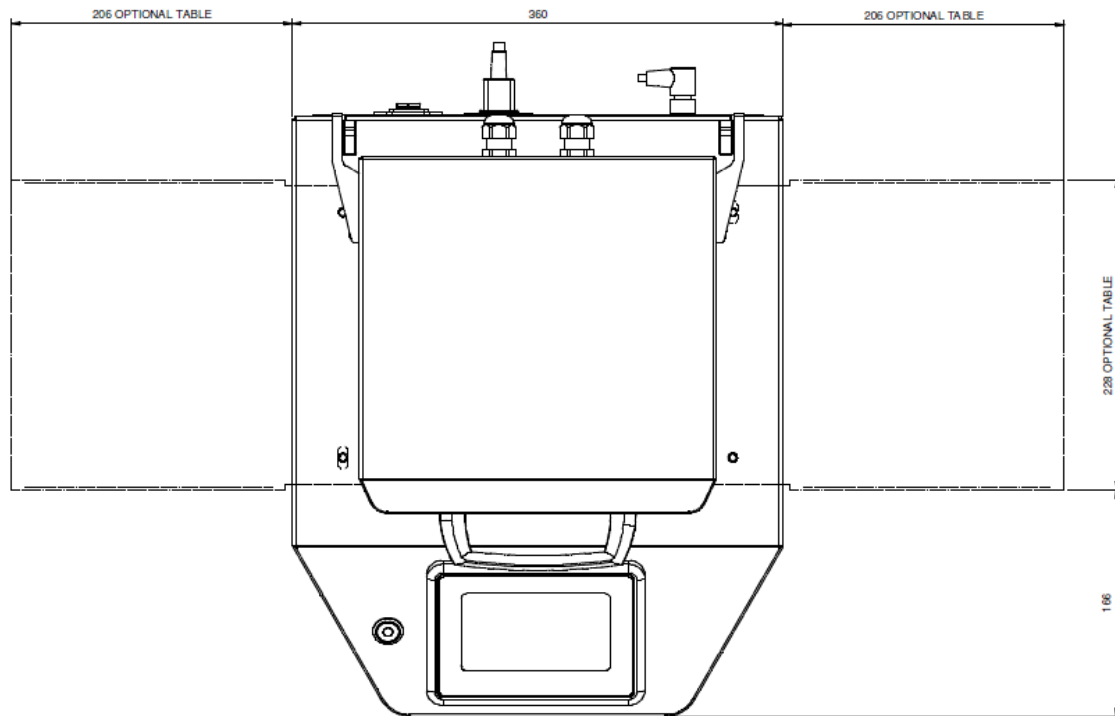

## EU Conformity

- Machinery Directive 2006/42/EC
- Low Voltage Directive (LVD) 2014/35/EU
- Electromagnetic Compatibility (EMC) Directive 2014/30/EU
- Waste Electrical and Electronic Equipment recycling (WEEE) Directive 2012/19/EU
- Restriction of Hazardous Substances (RoHS) Directive 2011/65/EU

## REVISION HISTORY

See front cover for publication number, e.g., 290-1720-1\$A

| Revision | Date     | Originator | Details of Revision          |
|----------|----------|------------|------------------------------|
| A        | 23.03.17 | CB         | First release for model 1720 |
|          |          |            |                              |