



OPERATOR'S GUIDE

TruBurst³
Intelligent Bursting
Strength Tester

Models 140 and 142

TruBurst³
Data Logger Software

Covering Serial Numbers
140/12/1001 and upwards
142/12/1001 and upwards

James H. Heal & Co. Ltd.
Halifax, England



Publication 290-140-1\$B
© 2012

Setting the Standard

Published by:

JAMES H. HEAL & CO. LTD.
RICHMOND WORKS
HALIFAX
WEST YORKSHIRE
HX3 6EP
ENGLAND

TELEPHONE +44 (0) 1422 366355
FACSIMILE +44 (0) 1422 352440

E-mail info@james-heal.co.uk
Internet <http://www.james-heal.co.uk>

© 2012

TABLE OF CONTENTS

OPERATOR’S GUIDE	1
Table of Contents	3
Table of Figures	4
Introduction to TruBurst ³	5
Standards	6
Installation	7
Health and Safety	7
Unpacking	7
Identification of Parts	8
Unpacking Check List	9
Instruments.....	9
Standard Accessories.....	9
Optional Accessories	10
Preparing the Instrument and Setting Up.....	11
Connecting to Services	11
Connecting to Electrical Supply	11
Connecting to Compressed Air Supply.....	11
Using the Laboratory or “Factory” Compressed Air Supply:	11
James Heal Optional Air Compressor:	11
Cyclic Testing:	11
Instrument Setup	12
Changing the Test Area (also referred to as Dome or Test Bell)	12
Adjusting the Clamp Pressure	14
Care and Maintenance	15
Daily Checks.....	15
Annual Checks	15
Customer Support	15
Touch Screen.....	16
Main Menu	17
Performing Bursting Tests.....	18
Pressure Control Method	18
FLOW CONTROL METHOD.....	21
Performing Cyclic Tests	23
Select a Standard.....	26

Editing a Standard	28
Part 1 - Specimen Data	28
Part 1 - Specimen Data - Entering Text	28
Part 2 - Machine Setup.....	29
Part 3 - Standard Definition.....	30
Part 4 - Cyclic Definition	31
Consumables List	32
System Setup.....	33
Machine Data.....	34
Data Logger	35
Requirements:	35
Connecting TruBurst ³ to a PC.....	35
Hardware Connections.....	35
Software Installation.....	35
Installation Wizard	36
Configuring the Software.....	38
Operating TruBurst ³ Data Logger.....	39
Trouble Shooting	41
Connecting TruBurst ³ to a Personal Computer	41
Electrical Wiring Schematic.....	42
Product Safety	43
Flow Control Calibration	44
Calibration of the James Heal TruBurst ³ (M&S P27 and Adidas 4.09)	44
Technical Data	46
Revision History.....	47

TABLE OF FIGURES

Figure 1: Lifting Points	8
Figure 2: Left Hand Side View	8
Figure 3: Right Hand Side View.....	8
Figure 4: Dome Assembly.....	9
Figure 5: Mains Input and Switch.....	11
Figure 6: Removing the Safety Guard	12
Figure 7: Removing the Test Dome	13
Figure 8: Removing the Clamp Ring.....	13
Figure 9: Arrangement of Parts under Clamp Ring	14

INTRODUCTION TO TRUBURST³

Thank you for investing in TruBurst³ from James Heal.

James Heal would like to assure you that we are committed to providing you with first class Instruments, Test Materials and excellent Customer Service and Support.

You are part of a growing community who considers James Heal products to be of the highest quality whilst offering excellent value for money.

TruBurst³ - Intelligent Bursting Strength Tester - fully pneumatic instrument comfortably exceeds the exacting requirements of the ISO 13938-2 standard and the company's own renowned standards for quality and performance.

The inherent flexibility of TruBurst³ enables testing of a broad range of materials from the textile, nonwoven, paper, board and plastics industries.

TruBurst³ is available in two (2) different models:

- Model 140 TruBurst³ capable of pressures up to 10 bar
- Model 142 TruBurst³ with Dual Control capable of pressures up to 10 bar

Both models of TruBurst³ are Intelligent Bursting Strength Testers with the incorporation of comprehensive statistical analysis to any printer via a connected Windows XP / Vista / 7 PC. Connection to a PC also enables storage of test reports and keyboard entry of text parameters. The TruBurst³ Data Logger application currently offers a choice of five (5) languages. In addition, cyclic testing is available - ideal as a research tool for testing materials that exhibit a high degree of elasticity. This enables specimens to be repeatedly cycled to either a pressure or distension (height). Each cycle is automatically recorded and a statistical analysis of the results is available.

Standards

TruBurst³ complies with the following standards:

- ISO 13938-2 (Textile)
- ASTM D 3786 (Textile)
- Next Test Method 22 (Textile)
- AWI Woolmark TM29 2000 (Textile)
- ISO 2758 (Paper)
- EDANA 80.3 (Nonwoven)

In addition, TruBurst³ Model 142 Dual Control complies with the following standards:

- M&S P27 (Fabric)
- M&S P27 (Lace)
- Adidas 4.09 (Textile)

In addition to these standards, both models of TruBurst³ also have:

- Extension and recovery (Cyclic Method)
- Rapid fatigue testing (Cyclic Method)

These have been defined to enable repetitive cycling to a pressure or distension.

TruBurst³ also offers the facility for the user to configure a standard to their own specification.

INSTALLATION

Health and Safety

- The instrument weighs approximately 60 kg. Therefore, do not attempt to move the unit without assistance from a colleague or suitable lifting apparatus.
- **TruBurst³** complies with the CE regulations in full, see Product Safety, on page 43 for details.
- **TruBurst³** has been specifically designed with operator health and safety in mind. This instrument ensures the minimum of operator stress and fatigue.
- **TruBurst³** utilises compressed air. Compressed air is potentially dangerous if misused. Carefully follow the installation guidelines when connecting **TruBurst³** to the air supply. If **TruBurst³** has been supplied with the optional high-pressure compressor, also refer to the separate User Manual supplied with the compressor.
- Do not use any compressed gasses other than compressed air.
- Never use oxygen, nitrogen, argon, helium, hydrogen, acetylene, propane or butane.
- Never apply compressed air to the surface of the human body.
- Never tamper with the interlocked safety guard or attempt to use **TruBurst³** without the safety guard in place. Tampering with the safety guard will expose the operator to serious risk from injury.



- Ensure the instrument is isolated from the electrical supply and disconnected from the compressed air supply before removing any covers. Ensure all residual air pressure has been released from the instrument.
- Fuses with the correct amperage rating must be used.
- Never use **TruBurst³** for anything other than what it is designed for.
- For Care and Maintenance requirements please refer to page 15 of this guide.

Unpacking

- **TruBurst³** is a heavy instrument. Use a fork lift truck or hydraulic pump-up trolley to move the packing case as near as possible to the final location. If **TruBurst³** is to be placed on a table or stand, ensure it is level, stable and of a sturdy construction.
- Remove the staples from each corner of the case lid and remove the lid.
- Carefully remove the packaging and contents from the upper part of the case. Note that any accessories ordered with the instrument are packed in this top section.
- Fold each top side of the case outwards.
- Carefully remove the packing from around the instrument.
- Very carefully lift the instrument out of its case and place it on a firm flat surface. To avoid damaging **TruBurst³**, lift the instrument using only the lifting points indicated in Figure 1, below.
- Do not dispose of any packaging material until all standard and optional accessories are accounted for. If there are any discrepancies, please contact your Agent immediately.

Identification of Parts

Figures 1 to 3 shown with Perspex Safety Guard removed for clarity.

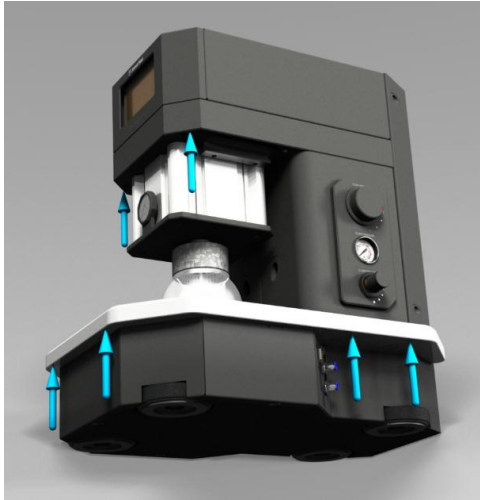

Figure 1: Lifting Points

To avoid damaging TruBurst³, lift the instrument using only the lifting points indicated

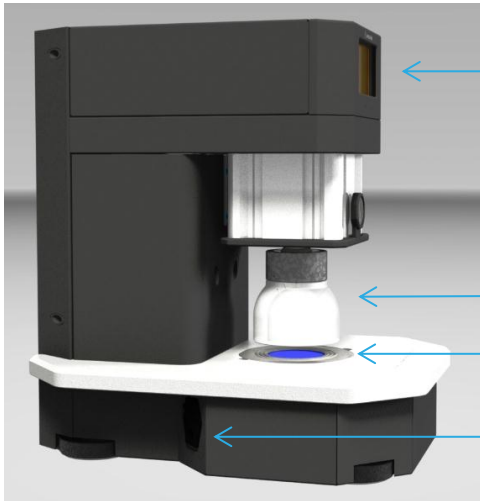

Figure 2: Left Hand Side View

Touch Screen

Dome Assembly

Diaphragm (blue area)

Mains Input

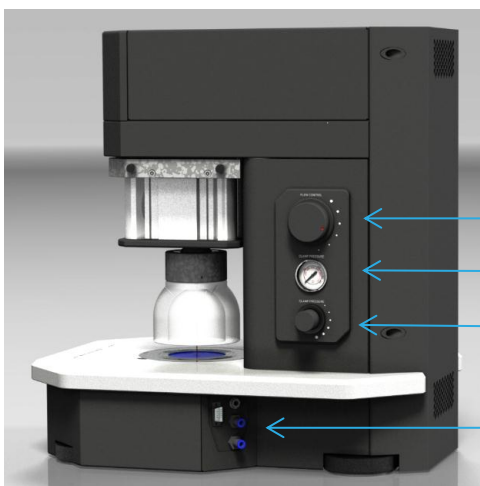

Figure 3: Right Hand Side View

Flow Control Adjustment (model 142 only)

Clamp Pressure Indicator (Pressure Gauge)

Clamp Pressure Adjustment

RS232 Serial Port, Foot Switch Jack, Compressed Air Input, Calibration Port.

Figure 4: Dome Assembly

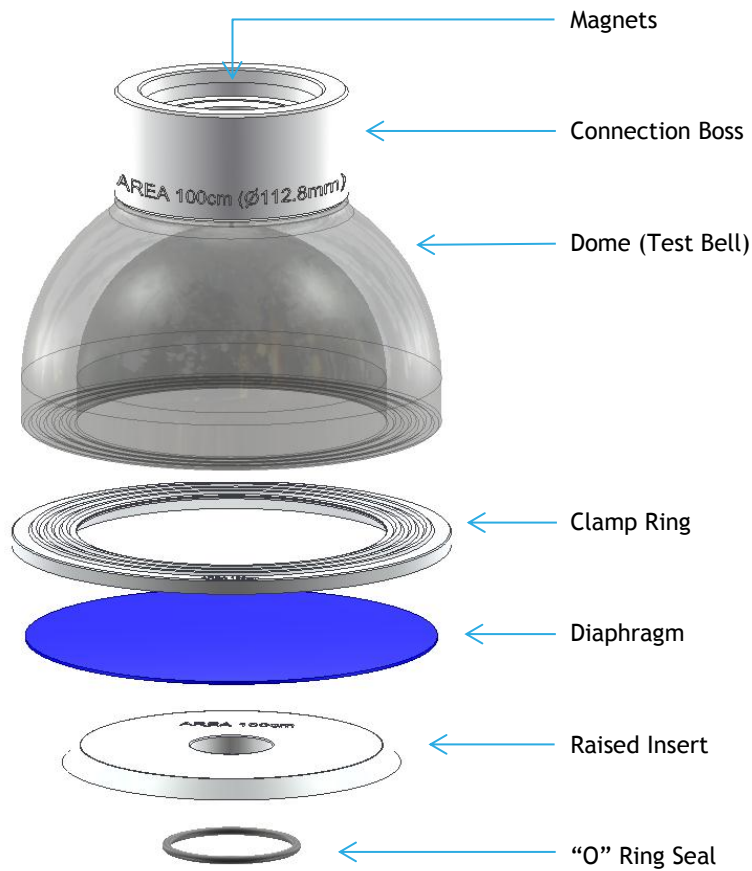

Unpacking Check List

Instruments

905-509	TruBurst ³ Model 140 90-264V 50/60Hz
905-510	TruBurst ³ Model 142 90-264V 50/60Hz (Dual Control model)

Standard Accessories

142-304	Mains Lead Set
160-448	Footswitch
327-266	Flexible Black Nylon Pipe (6mm) (2 m)
794-819	Pneumatic Adaptor for US
794-734	Data Logging CD
154-128	Computer Interface Cable
550-005	Calibration Blanking Plate (model 142 only)

Optional Accessories

202-140	UKAS Certificate of Calibration
794-685	7.8 cm ² Dome Assembly
794-684	7.3 cm ² Dome Assembly
794-683	10 cm ² Dome Assembly
794-682	50 cm ² Dome Assembly
794-681	100 cm ² Dome Assembly
794-685	7.8 cm ² Dome Assembly
777-133	Reinforced Diaphragms (1mm) - per pack (10)
777-134	Plain Diaphragms (1mm) - per pack (10)
777-135	Reinforced Diaphragms (1.5mm) - per pack (10)
777-150	Low Pressure Diaphragms (0.15 -0.20mm) per pack (10)
783-240	Compressor 230V 50Hz
783-241	Compressor 110V 60Hz
140-spares	2- Year Spares Kit, comprising
356-399	O-ring (3)
390-271	Air Filter
390-244	Solenoid/Spring Valve
390-245	Solenoid Valve
390-207	Exhaust Silencer
130-825	Fuse 1A (2)

Preparing the Instrument and Setting Up

Connecting to Services

Stand the instrument on a firm, level table or surface.

Connecting to Electrical Supply

The instrument is wired for a universal mains input: single phase 90-264V AC 50-60 Hz. **TruBurst³** will automatically adjust for the above voltages.

Connect the instrument to the correct electrical supply using the mains lead supplied. The power rating for **TruBurst³** (excluding Printer and PC) is 40 watts.

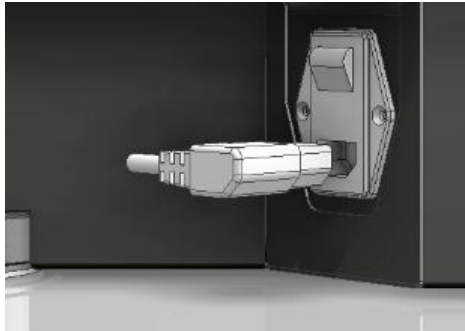

Figure 5: Mains Input and Switch

Connecting to Compressed Air Supply

Using the Laboratory or “Factory” Compressed Air Supply:

Air consumption will vary according to the type and frequency of testing being carried out. The following compressed air supply is recommended for normal continuous testing in accordance with ISO 13938-2:

Free Air Delivery:	33 litres/min
Maximum pressure:	10 bar (145psi) regulated
Minimum pressure:	6 bar
Filtration:	5 microns (absolute) or better to remove excess particulates, oil and moisture.

The capacity of **TruBurst³** will be limited to the pressure of the compressed air supply. **TruBurst³** is fitted with on-board filtering. However, a heavily contaminated compressed air supply (not filtered) will result in early blockage of the on-board filter element.

James Heal Optional Air Compressor:

The optional compressor is supplied with a filter and regulator fitted as standard. The compressor has sufficient air delivery for normal testing in accordance with ISO 13938-2 with a 50% duty cycle. This is equivalent to one burst every 60 seconds for continuous use.

Cyclic Testing:

TruBurst³ has the facility to perform cyclic testing. The target pressure, test duration and frequency will dramatically affect the compressed air consumption. The compressed air supply should be sized to satisfy testing requirements.

The supply of compressed air should be regulated to 10 bar maximum.

Oil lubrication of the factory compressed air supply is not required nor recommended. **TruBurst³** is supplied with a 2m length of 6mm nylon hose for connection to a suitable compressed air supply. Using with a longer pipe is not recommended, resulting in air supply inefficiency.

Ensure all equipment used for connection, including pipes and fittings have a safe working pressure greater than that of compressed air supply.

If the optional compressor has been purchased, ensure the compressor is situated in a well-ventilated area with a clean source of air. Refer to compressor User Manual for full installation details and maintenance schedule.

WARNING - do not attempt to disconnect any pneumatic pipe without first expelling the excess air by repeatedly depressing the clamp/unclamp button several times.

To remove the compressed air pipe from the rear of the instrument, fully depress the locking ring on the pneumatic fitting towards the instrument while simultaneously withdrawing the pipe. **DO NOT FORCE THE PIPE.**

Instrument Setup

Switch **TruBurst³** on using the switch at the left hand side of the instrument. Allow the instrument to warm up for 5 minutes before commencing testing.

Changing the Test Area (also referred to as Dome or Test Bell)

It is not necessary to switch off the instrument to change test areas. Ensure the instrument is in the unclamped (open) position with any specimens removed.

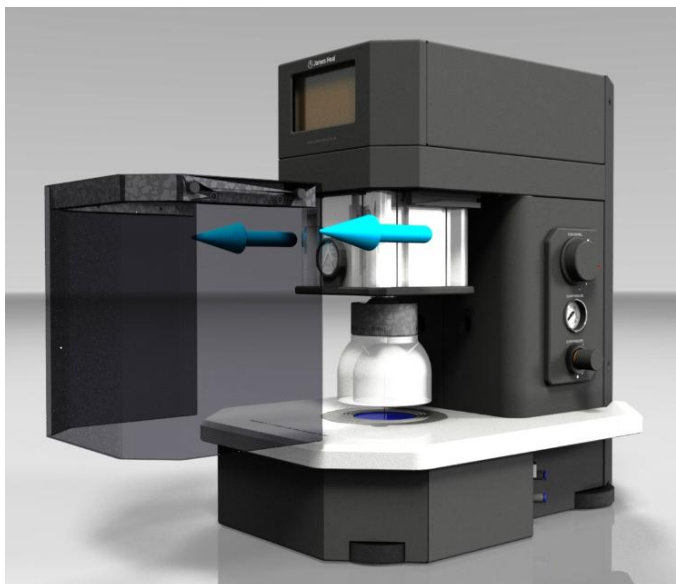

Figure 6: Removing the Safety Guard

Remove the transparent plastic Safety Guard. The Safety Guard is best removed by standing in front of TruBurst³ and pulling the Safety Guard in a horizontal direction, away from the instrument. Reasonable force may be required to disengage the guard. The instrument will not operate and is safe with the guard removed.

Remove the Test Dome from the end of the Clamp Piston by carefully pulling vertically downwards. The Dome is held secure by magnetic force. Place the Test Dome where it cannot roll and be damaged.



Figure 7: Removing the Test Dome

With the Test Dome removed, the stainless steel Clamp Ring can be removed by pressing with your thumb on the top surface close to the outer edge. The Clamp Ring will lift up at the opposite edge.

Remove the rubber diaphragm and replace if damaged or worn. The stock code for re-ordering is marked on the diaphragm. Alternatively see accessories list or the Consumables Menu.

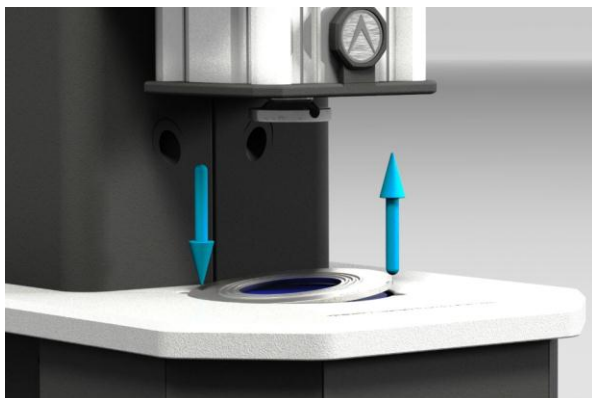

Figure 8: Removing the Clamp Ring

Remove the Raised Insert by pulling vertically upwards. Ensure the rubber O-ring seal remains seated in the groove. Replace if damaged.

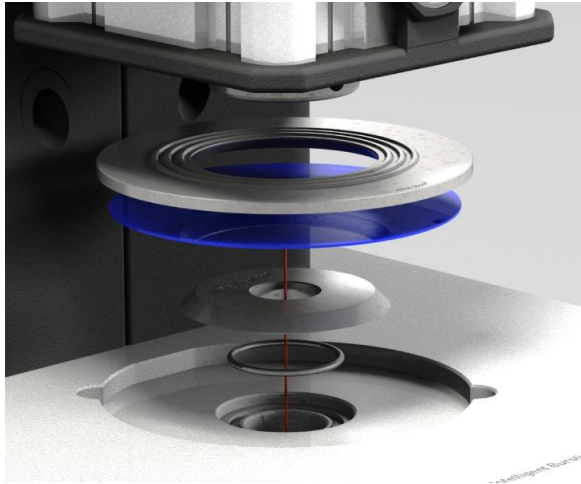

Figure 9: Arrangement of Parts under Clamp Ring

Replace the Raised Insert with the desired test area.

Note: the test area (cm²) and diameter (mm) is marked on each part.

Lay the rubber Diaphragm centrally over the Raised Insert.

Note: it is advisable to use a different diaphragm for different test areas.

Replace the Clamp Ring over the top of the diaphragm, locating in the diaphragm housing.
Note: the Clamp Ring has a flat edge. This is an anti-rotation feature and must be aligned with the profile of the diaphragm housing.

Assemble the Test Dome onto the end of the clamp piston.

The Test Dome is held in place by magnetic force.

Replace the Safety Guard onto the guide rails. Ensure the Safety Guard is fully home and the tabs are engaged. A 'clunk' should be heard when the guard is engaged.

Before continuing testing it is necessary to change the settings for the new test area. Select the Standard Definition, see page 30, and select the new test area. Exit Menu and commence testing.

Adjusting the Clamp Pressure

TruBurst³ has the potential to develop a massive clamp force (approx. 1.3 tonnes) that may be unsuitable for testing delicate fabrics. Excessive clamp force can cause premature specimen failure close to the Clamp Ring. The clamp force can be varied to suit a particular specimen.

To reduce the clamping force, turn the Clamp Pressure Adjustment knob counter-clockwise. The corresponding pressure is displayed on the Pressure Gauge. To increase the clamping force, turn the knob clockwise. Reducing the clamp pressure below 3 bar may not be sufficient to operate the clamp. Some experimentation may be necessary to obtain an optimum pressure setting for a given specimen material.

The clamp pressure can be recorded and printed out on the test report.

CARE AND MAINTENANCE

TruBurst³ has been designed using specially selected materials and components to ensure maintenance free operation for long periods of time. Although TruBurst³ is almost maintenance free, it is recommended that the following checks be made:

Daily Checks

- Ensure the TruBurst³ is clean and free from fibres or debris.
- Test Domes should be cleaned with a non-abrasive cotton cloth and a non-solvent cleaning solution.
- Check the condition of the Diaphragm for abrasion or excessive deformation. Replace if necessary.
- Check transparency of the Safety Guard and Test Domes. Frosted or cracked Test Domes/Safety Guard must be replaced to maintain safety.
- If the optional high-pressure compressor has been purchased, refer to compressor instruction manual for maintenance checks. Check the oil level and drain condensation from the air reservoir on a weekly basis.
- Check for air leaks. Leaks can usually be heard. Excessive leakage wastes electricity and could cause the compressor to overheat.
- TruBurst³ has an integral self-draining air filter that removes particles and moisture. Occasionally a few droplets of water may be found underneath the instrument when the filter automatically drains. This is perfectly normal and any water should evaporate quickly.
- Fuses are located in the Mains Input.

Annual Checks

- Check the condition of the O-ring seal. This should be free from cuts or abrasion, replace if necessary.
- Check the general condition of the Perspex Test Domes. Test Domes should be highly transparent and free from scratches or abrasion, replace if necessary.
- Check the transparency of the Safety Guard. A frosted or damaged guard must be replaced to maintain safety.
- Powerful magnets are used on the Dome Assemblies. These magnets may attract iron particles. These can be easily removed using an adhesive tape.

Customer Support

James Heal Service & Calibration are available Worldwide - Contact our Service & Calibration Department for further details. Service & Calibration is a totally comprehensive, worldwide support programme. When you buy instrumentation from us, it is the beginning rather than the end of a relationship. Our aim is simple: to provide precisely the services you need to maintain and protect the value of your investment.

In all communications please quote the serial number of your instrument, for example, 142/12/1001.

TOUCH SCREEN

The **TruBurst³** control panel uses resistive touch-screen technology.

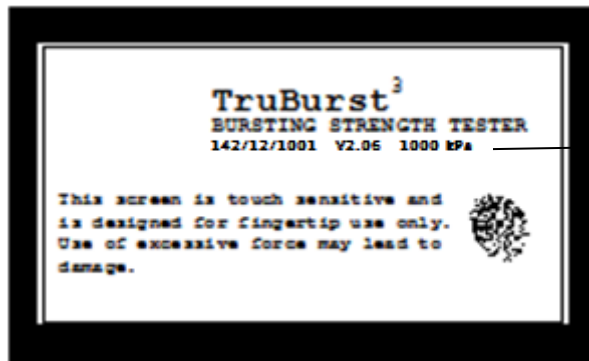

This is the instrument name, serial number and pressure range.

Touch the screen to continue.

Title Screen

The highlight bar shows the selected Option.

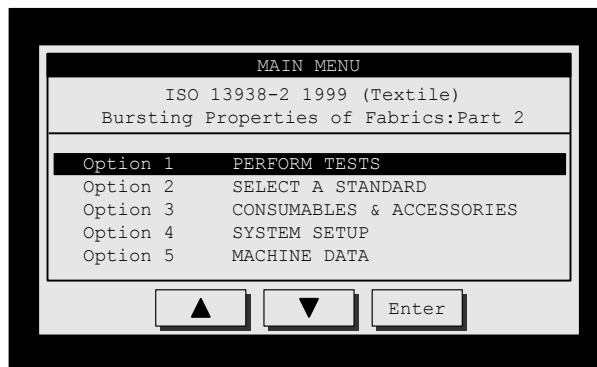

This is the currently selected Standard.

These are the up/down and Enter navigation touch keys.

Main Menu Screen

Screen is updated every 0.1s with real-time pressure, distension and time data.

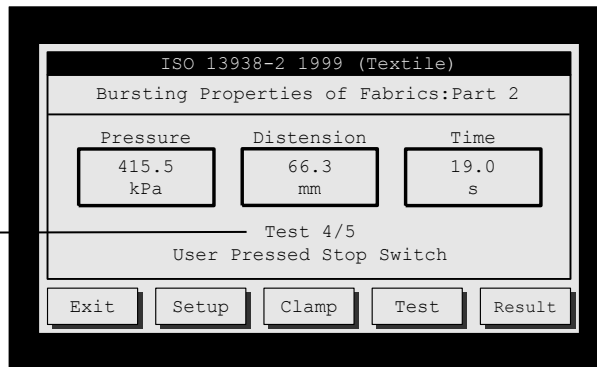

Digital displays boxes showing Pressure, Distension and time.

Information about the test.

Various control keys

Test Screen

Main Menu

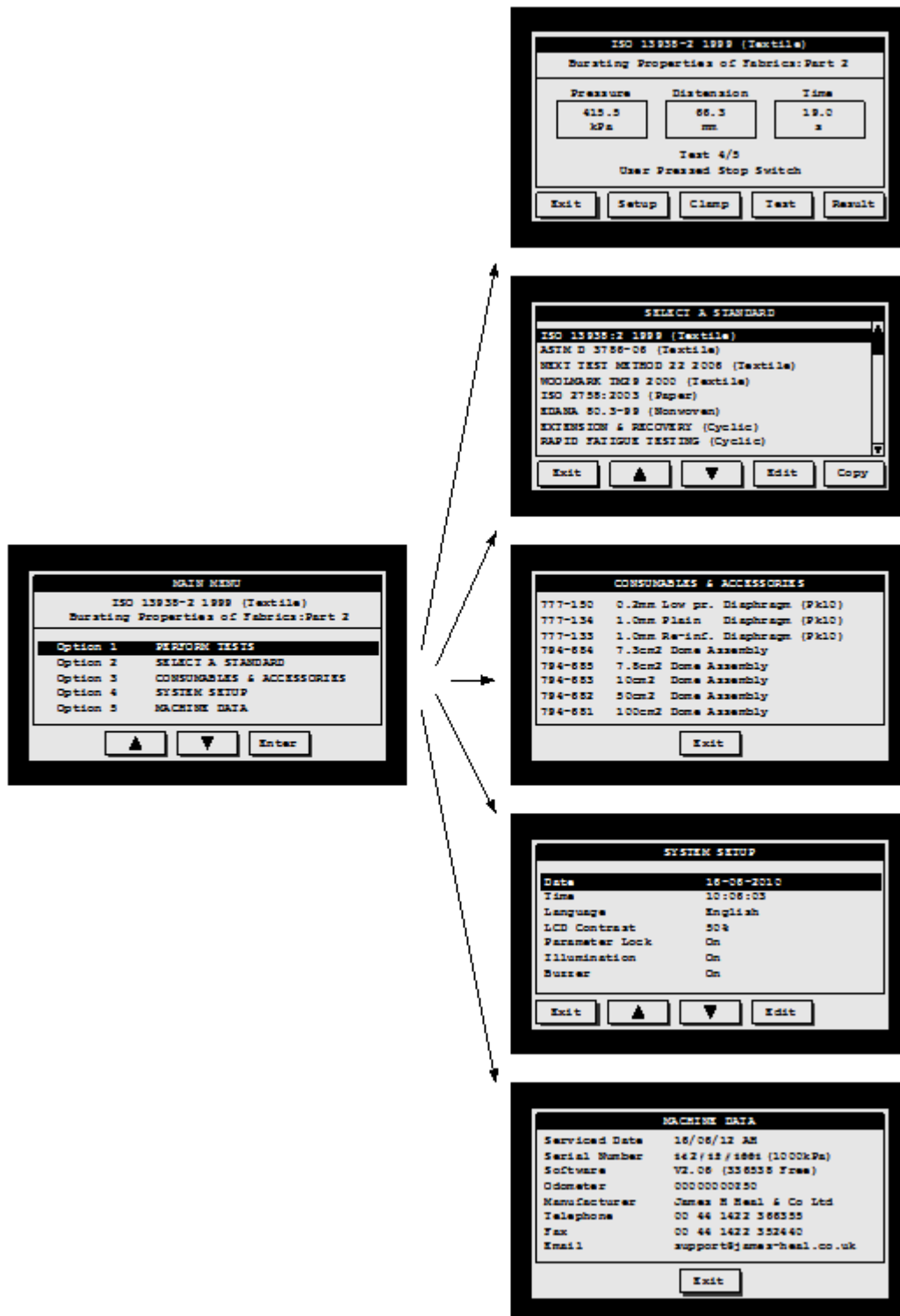

PERFORMING BURSTING TESTS

Pressure Control Method

This method is applicable to both models 140 and 142.

This example uses the standard ISO 13938-2 test method and guides you through performing a burst test, applying a diaphragm correction and sending the results to the TruBurst³ Data Logger on a PC.

Step 1

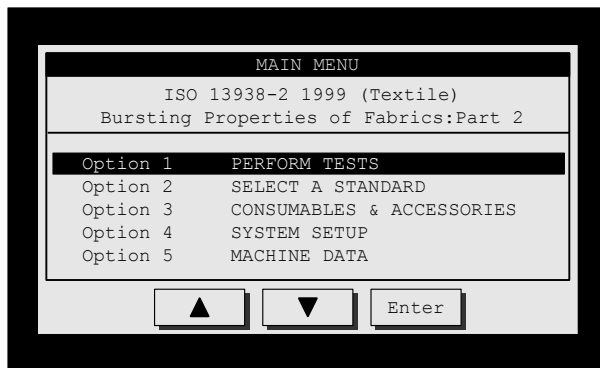

Perform Tests

Use the ▲ and ▼ keys on the MAIN MENU to highlight: “Option 1 PERFORM TESTS”

Then press the Enter key. See the “Select a Standard” section if you wish to use a different Standard.

Step 2

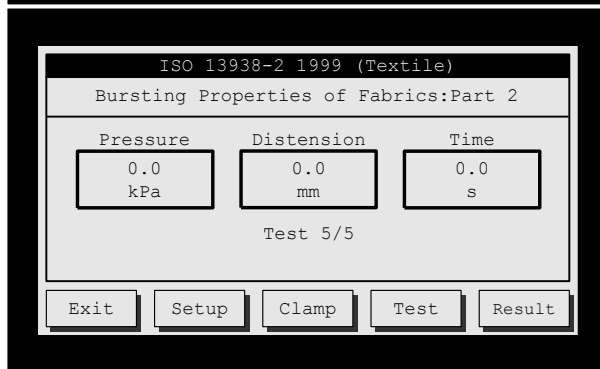

Start the Test

Place your specimen under the Test Dome and make sure it is perfectly flat. Now press the Clamp key and the clamp will be lowered onto the specimen. Press the Test key to start the test.

Did you know?

For hands-free operation of the Clamp you can use the supplied footswitch.

Save the Result

Step 3

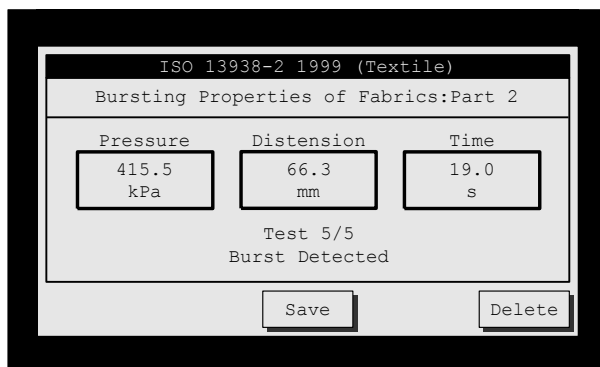

The instrument will automatically stop if it detects a burst and will display the final test result. You now have the option to Save or Delete the result.

Step 4



Step 5

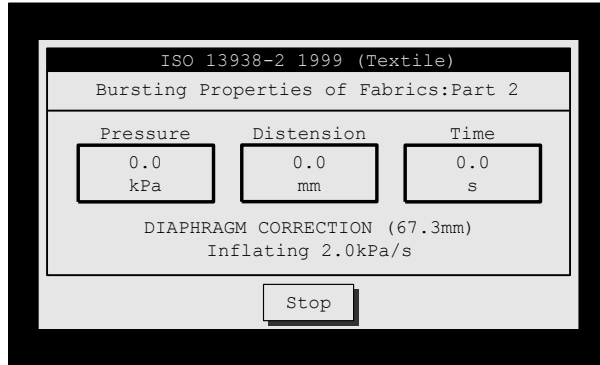

Step 6

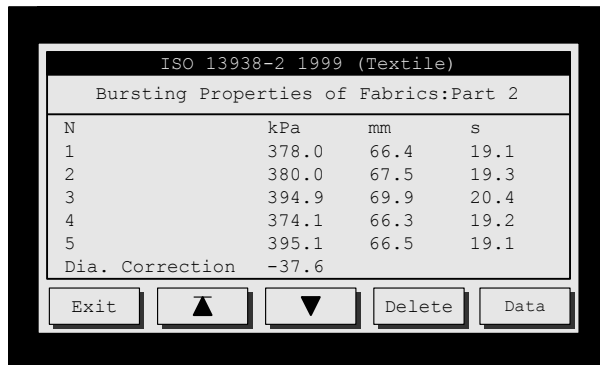

Step 7

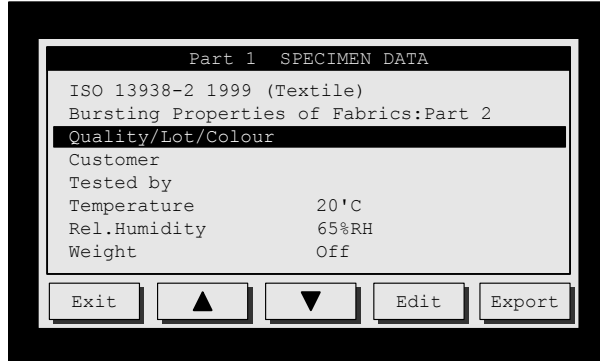

Diaphragm Correction

This screen is automatically displayed when you have completed the required number of tests. Press the **No** key if you do not require Diaphragm Correction otherwise, press **Yes**, and the instrument will inflate to the average distension height of the tests you have just performed.

Observe Diaphragm Correction

The diaphragm is now slowly inflated to the average distension height - in this case 67.3mm at a rate of 2kPa/s. The pressure to achieve this height is recorded and automatically subtracted from the pressure results.

View the Test Results

The individual results, diaphragm correction and statistics are now displayed. Press the **▲** and **▼** keys to view more of the results. **Delete** will erase these results. If you wish to send the results to a PC press the specimen **Data** key.

Fill in the Specimen Data

Here you have 5 lines of text which can include the Standard name/description along with specimen details such as: quality, lot, colour, customer, tested by etc. To edit any text, use the **▲** and **▼** keys and press **Edit** and a "QWERTY" keyboard will be displayed. You can also record the test conditions and specimen weight.

Step 8

Document	000002		
Date	12-04-2012		
Time	10:37:15		
ISO 13938-2 1999 (Textile)			
Quality/Lot/Colour			
Customer			
Tested by			
Condition	20°C 65%RH		
N Tests	5		
Diaphragm	1.0mm		
Test Area (Dia)	50cm ² (79.6mm)		
Inflation Rate	20.0kPa/s		
Correction Rate	2.0kPa/s		
Burst Detection	Normal		
Clamp Pressure	400.0kPa		
Test	kPa	mm	s
1	378.0	66.4	19.1
2	380.0	67.5	19.3
3	394.0	69.9	20.4
4	374.1	66.3	19.2
5	395.1	66.5	19.1
Dia. Correction	-37.6	67.3	15.0
Mean	384.4	67.3	19.4
CV%	2.57	2.29	2.85
Q95% Range	11.38	1.77	0.64
Q95% Min	373.0	65.6	18.8
Q95% Max	395.8	69.1	20.1
Instrument	TruBurst Model 142		
Machine S/N	142/12/1001 (1000kPa)		
Software	V2.06		
Manufacturer	James H Heal & Co. Ltd		

Document Reference

Specimen Data

Test Parameters

Individual results

Statistics

Machine Information

Send the Results to a PC

Run the Data Logger software on your PC - see the section on the Data Logger if it is not already installed.

When the Data Logger is ready press the **Export** key on *TruBurst*³ and the results will appear on the PC screen.

FLOW CONTROL METHOD

This method is only applicable to model 142.

This example uses the Marks & Spencer standard M&S P27:2010 (FABRIC) test method and guides you through performing a burst test and sending the results to the TruBurst³ Data Logger on a PC.

Step 1

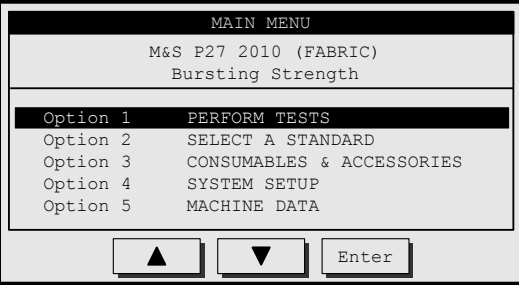

Step 2

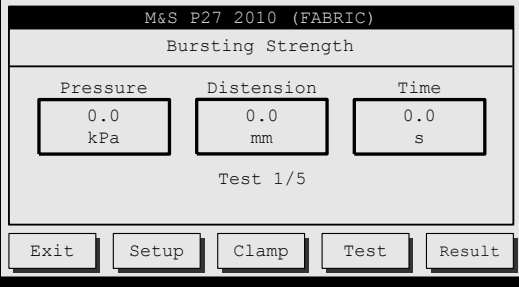

Step 3

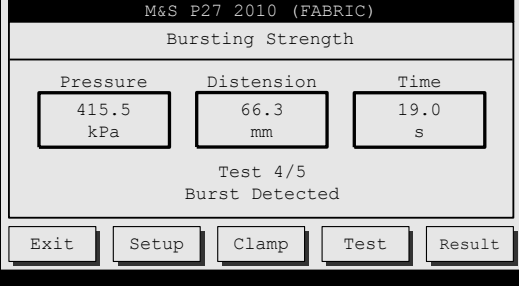

Step 4

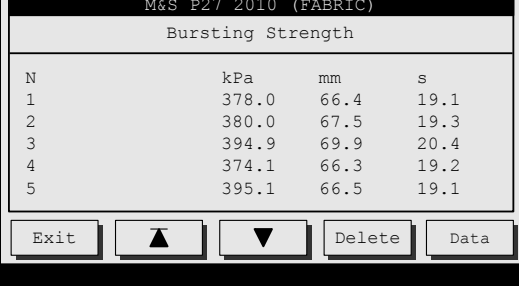

Perform Tests

Use the ▲ and ▼ keys on the MAIN MENU to highlight: “Option 1 PERFORM TESTS” Then press the Enter key. See the “Select a Standard” section if you wish to use a different Standard.

Start the Test

Place your specimen under the Perspex dome and make sure it is perfectly flat. Now press the **Clamp** key and the clamp will be lowered onto the specimen. Press the **Test** key to start the test.

Save the Result

The instrument will automatically stop if it detects a burst and will display the final test result. You now have the option to **Save** or **Delete** the result.

View the Test Results

The individual results, diaphragm correction and statistics are now displayed. Press the ▲ and ▼ keys to view more of the results. **Delete** will erase these results. If you wish to send the results to a PC press the specimen **Data** key.

Step 5

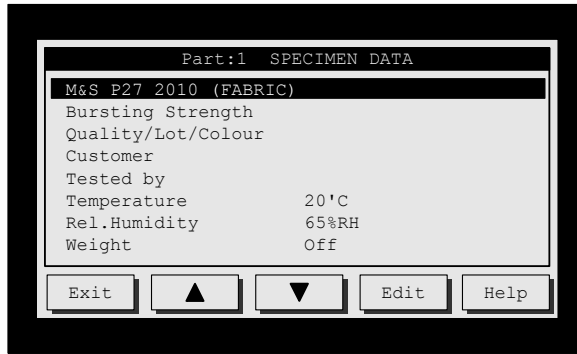

Fill in the Specimen Data

Here you have 5 lines of text which can include the Standard name/description along with specimen details such as: quality, lot, colour, customer, tested by etc. To edit any text, use the ▲ and ▼ keys and press **Edit** and a “QWERTY” keyboard will be displayed. You can also record the test conditions and specimen weight.

Step 6

Document	000002	Document Reference		
Date	16-04-2012			
Time	10:37:15			
M&S P27 2010 (FABRIC)				
Quality/Lot/Colour		Specimen Data		
Customer				
Tested by				
Condition	20°C 65%RH			
N Tests	5	Test Parameters		
Diaphragm	1.0mm			
Test Area (Dia)	50cm2 (79.8mm)			
Inflation Rate	24.0kPa/s			
Burst Detection	Normal			
Clamp Pressure	400.0kPa			
Test	kPa	mm	s	Individual results
1	378.0	66.4	19.1	
2	380.0	67.5	19.3	
3	394.0	69.9	20.4	
4	374.1	66.3	19.2	
5	395.1	66.5	19.1	
Mean	384.4	67.3	19.4	
CV%	2.57	2.29	2.85	Statistics
Q95% Range	11.38	1.77	0.64	
Q95% Min	373.0	65.6	18.8	
Q95% Max	395.8	69.1	20.1	
Instrument	TruBurst Model 142			Machine Information
Machine S/N	142/12/1001 (1000kPa)			
Software	V 2.06			
Manufacturer	James H Heal & Co. Ltd			

Send the Results to a PC

Run the Data Logger software on your PC - see the section on the Data Logger if it is not already installed. When the Data Logger is ready press the **Export** key on *TruBurst*³ and the results will appear on the PC screen.

Performing Cyclic Tests

This example uses the EXTENSION & RECOVERY (Cyclic) test method and guides you through performing cyclic tests and sending the results to a PC.

Select 'Option 2 Select a Standard' in Main Menu then choose or create selected standard, see 'Select a Standard', page 26, for more information.

Step 1

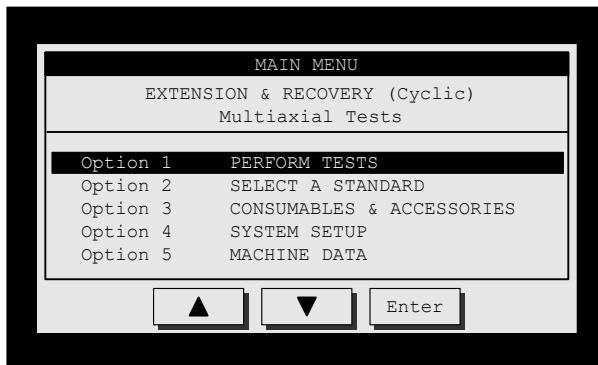

Perform Test

Use the ▲ and ▼ keys on the MAIN MENU to highlight: "Option 1 PERFORM TESTS" Then press the Enter key. See the "Select a Standard" section if you wish to use a different Standard.

Step 2

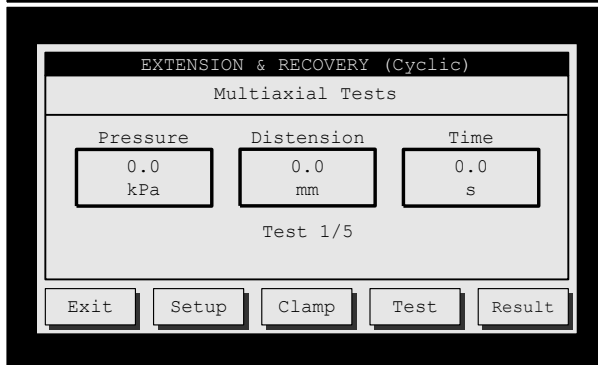

Start the Test

Place your specimen under the Perspex dome and make sure it is perfectly flat. Now press the **Clamp** key and the clamp will be lowered onto the specimen. Press the **Test** key to start the test.

Step 3

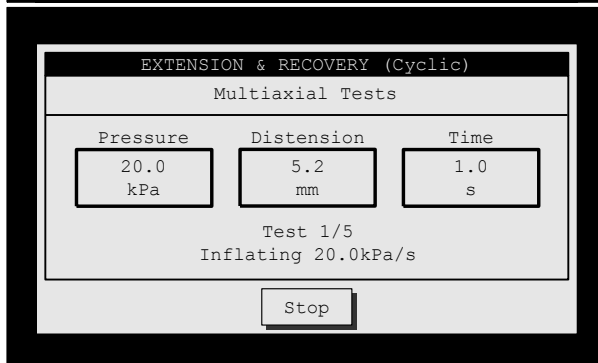

Phase A - Inflating

Inflation rate can be changed in set-up. The pressure will increase in a linear fashion - in this case 20kPa/s until the target is reached. You can manually end the test at any time by pressing the **Stop** key or footswitch. Make sure inflation rate is lower than target rate.

Phase B - Target Hold Time

The pressure will now be maintained to hold the required target value for the duration specified. This amount can be altered in set up under target hold time.

Step 4

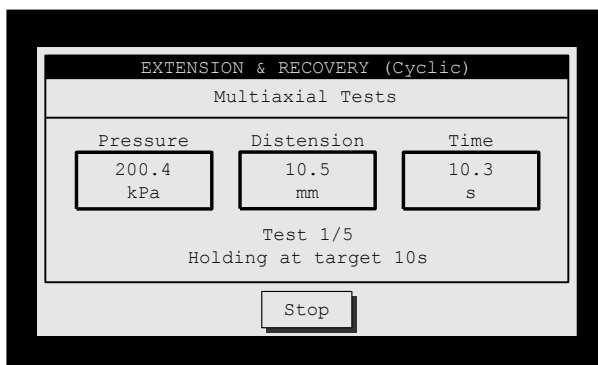

Step 5

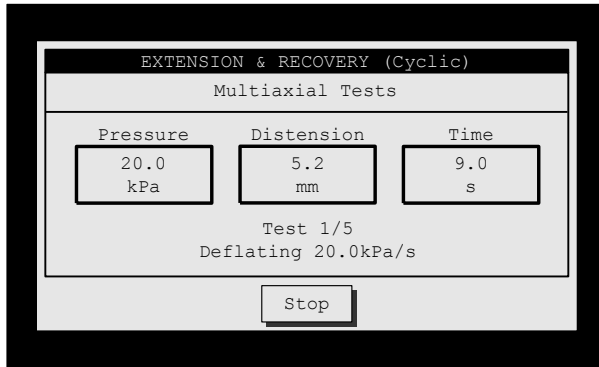

Step 6

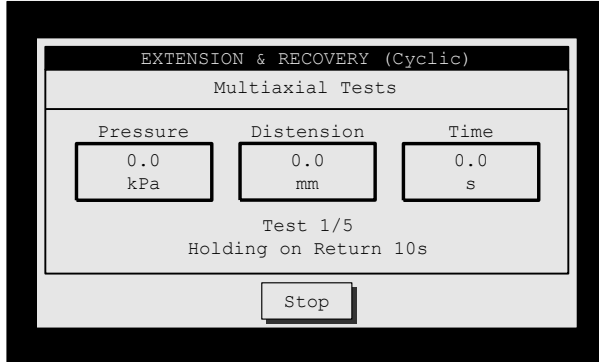

Step 7

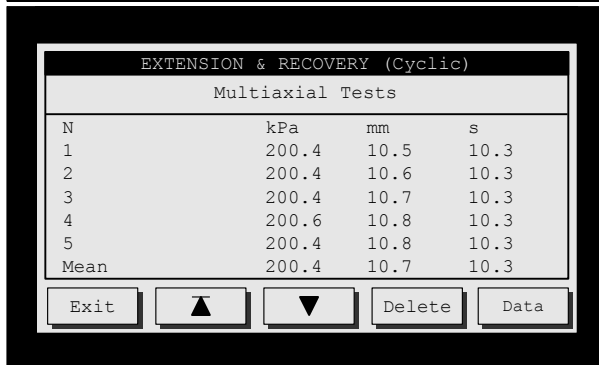

Step 8

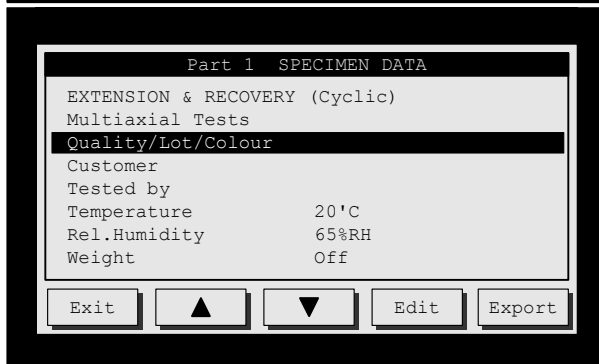

Phase C - Deflating

The pressure will decrease in a linear fashion - in this case 20kPa/s until the pressure returns to zero.

Phase D - Return Hold Time

The specimen will be kept at zero pressure for the required holding time. The cycle begins again from Step 3 for the number of cycles specified. For “rapid fatigue testing” phase b and d should be set to Zero.

View the Test Results

The individual results, diaphragm correction and statistics are now displayed. Press the ▲ and ▼ keys to view more of the results. **Delete** will erase all results. If you wish to send the results to a PC press the Specimen **Data** key.

Fill in the Specimen Data

Here you have 5 lines of text which can include the Standard name/description along with specimen details such as: quality, lot, colour, customer, tested by etc. To edit any text, use the ▲ and ▼ keys and press **Edit** and a “QWERTY” keyboard will be displayed. You can also record the test conditions and specimen weight.

Step 9

Document	000013	Document Reference
Date	12-04-2012	
Time	14:45:00	
EXTENSION & RECOVERY (Cyclic)		
Multiaxial Tests		
Quality/Lot/Colour		Specimen Data
Customer		
Tested by		
Condition	20°C 65%RH	
N Cycles	5	
Diaphragm	1.0mm	
Test Area (Dia)	10cm ² (35.7mm)	
Inflation Rate	20.0kPa/s	Test Parameters
Target	200.0kPa	
Target Hold	10s	
Return Hold	10s	
Burst Detection	Off	
Clamp Pressure	400.0kPa	
Test	kPa mm s	
1	200.4 10.5 10.3	Individual results
2	200.4 10.6 10.3	
3	200.4 10.7 10.3	
4	200.6 10.8 10.3	
5	200.4 10.8 10.3	
Mean	200.4 10.7 10.3	
CV%	0.05 0.92 0.00	
Q95%	0.12 0.11 0.00	Statistics
Q95% Min	200.3 10.6 10.3	
Q95% Max	200.6 10.8 10.3	
%Decay	2.86	
Instrument	TruBurst Model 142	Machine Information
Machine S/N	142/12/1001 (1000kPa)	
Software	V 2.06	
Manufacturer	James H Heal & Co. Ltd	

Send the Results to a PC

Run the Data Logger software on your PC - see the section on the Data Logger if it is not already installed. When the Data Logger is ready press the **Export** key and the results will appear on the PC screen.

Select a Standard

From here you can select a pre-programmed or user defined Standard.

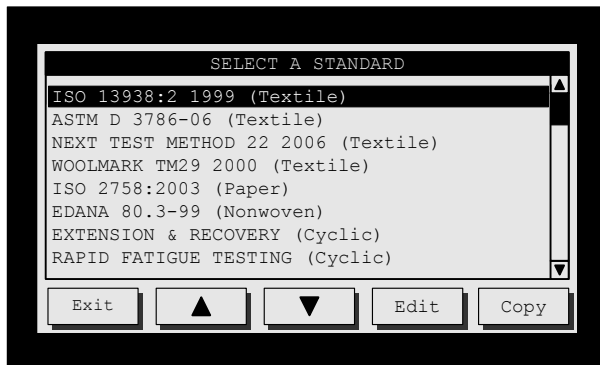

Exit selects the highlighted Standard and takes you back to the previous screen	▲ and ▼ moves the highlight bar up or down	Edit lets you change the highlighted Standard	Copy copies the selected Standard to a User Defined memory slot
--	---	--	--

		Confirm confirms you want to copy the Standard to the highlighted slot	
--	--	---	--

Did you know?

All parameters are retained in memory when the instrument is switched off.

To quickly move through the Standards list simply touch the area within the scroll bar on the right-hand side of the screen.

Pre-Programmed Standards

There are 11 pre-defined Standards to choose from:

1. ISO 13938:2 1999 (Textile)
2. ASTM D 3786-06 (Textile)
3. NEXT TEST METHOD 22 2006 (Textile)
4. WOOLMARK TM29 2000 (Textile)
5. ISO 2758:2003 (Paper)
6. EDANA 80.3-99 (Nonwoven)
7. EXTENSION & RECOVERY (Cyclic)
8. RAPID FATIGUE TESTING (Cyclic)
9. M&S P27 2010 (Fabric)
10. M&S P27 2010 (Lace)
11. Adidas 4.09 (Textile)

User Defined Standards

There are 50 user definable memory slots for storing your favourite settings in. Each one can be customised for a particular product and instantly recalled for future use.

Creating a User Defined Standard

These can be based on a Standard that has been copied from the Pre-Programmed Standards OR simply selected and edited.

To copy a Pre-Programmed Standard use the **▲** and **▼** keys to highlight the Standard that you want to base your user defined Standard on. Now press **Copy** and **TruBurst³** will highlight the first available slot that is free. If you are happy with the location press **Confirm**. If you would like to choose another location use the **▲** and **▼** keys then press **Confirm**. You can exit the copy process at any time by pressing **Exit**.

To edit a User Defined Standard use the **▲** and **▼** keys to highlight the required Standard. Now press **Edit**. The following pages give a detailed explanation of each part of the Standard.

Editing a Standard

Every Standard is logically grouped into 4 sections:

- Part 1 Specimen Data
- Part 2 Machine Setup
- Part 3 Standard Definition
- Part 4 Cyclic Definition

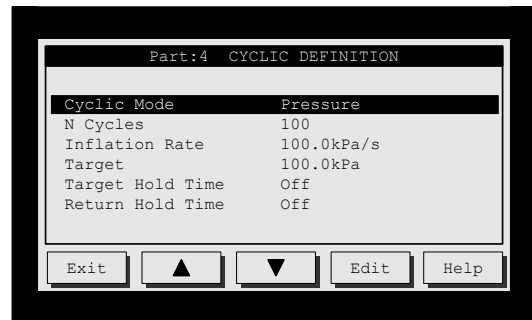
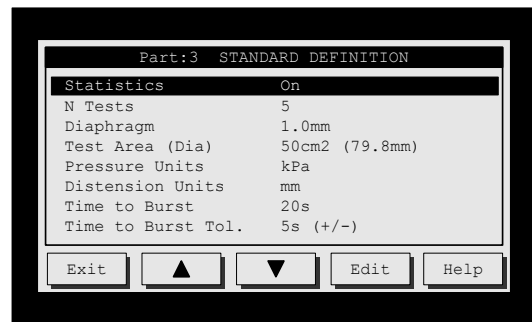
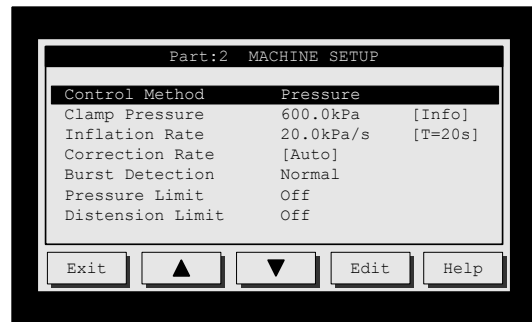
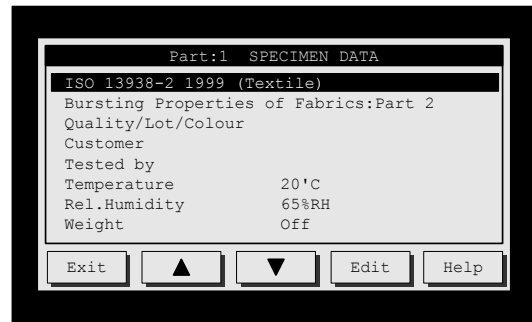
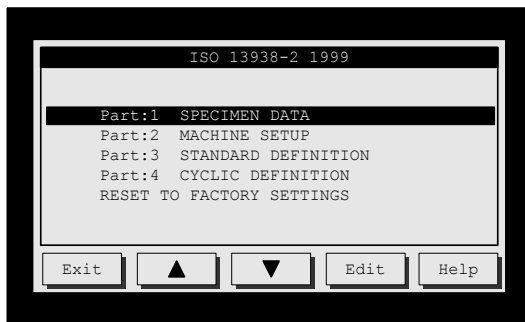

With the **Parameter Lock OFF** each Standard can be reverted back to its original settings by selecting the **Reset to Factory Settings** option.

Editing a Standard

Part 1 - Specimen Data

This part of the Standard is for recording information about the specimen and will appear on the test report. This menu will also appear once tests have been completed and ready to export to computer.

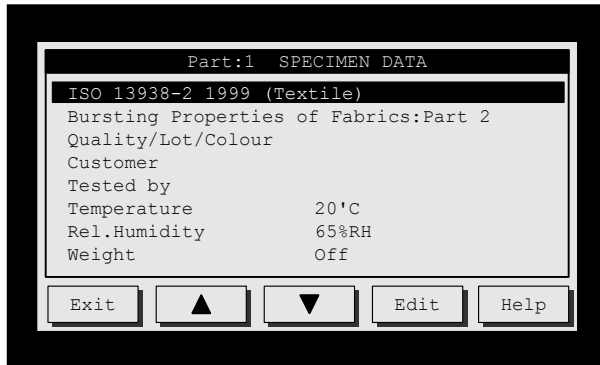

Exit takes you back to the previous screen	▲ and ▼ moves the highlight bar up or down	Edit lets you change the highlighted item	Help displays more information about selected item
---	--	--	---

Part 1 - Specimen Data - Entering Text

The QWERTY keyboard lets input alpha-numeric characters quickly and easily.



Text (5 lines x 39 character)

This text can include the Standard name/description along with specimen details such as: batch, lot, colour, operator and observations. Press the Edit key to change the text.

Temperature (Range: 0 to 50°C)

This is the temperature the test specimens have been conditioned in. Typical laboratory conditions are 20°C 65%RH for textiles and 23°C 50%RH for paper.

Relative Humidity (Range: 0 to 99%RH)

This is the relative humidity the test specimens have been conditioned in. Typical laboratory conditions are 20°C 65%RH for textiles and 23°C 50%RH for paper.

Weight (0 to 500g/m²)

This is the specimen weight in g/m² used to calculate the burst factor/index normally used for paper tests. Set it to 0 if not required.

The QWERTY keyboard has 4-lines of alpha-numeric characters. The bottom row of keys perform the following functions:

ESC lets you Escape without making any changes	▲ and ▼ Select upper or lower case characters	Delete removes characters from the text
Space inserts blank characters	Enter Completes the text entry	< and > move the cursor position

To insert a character move the cursor to the end of the text then press the required keys.

To overwrite a character position the cursor within the text then press the required key.

Did you know?

Pressing any key with the cursor on the first character erases the whole line with just one key press.

Part 2 - Machine Setup

These parameters affect how the instrument performs during a test.

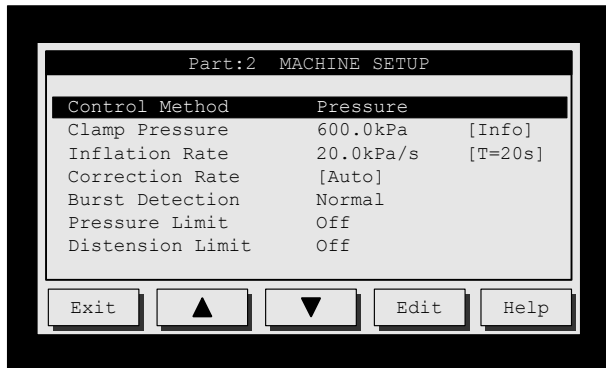

Exit takes you back to the previous screen	▲ and ▼ moves the highlight bar up or down	Edit lets you change the highlighted item	Help displays more information about selected item
---	--	--	---

Did you know?

You can quickly access this menu from the “Test Screen” by pressing the Setup key.

Control Method (Options: Pressure, Flow) TruBurst³ model 142 is a “**Dual Control**” instrument and can control by either pressure or flow.

When set to ‘**Pressure**’ the pressure will automatically increase in a linear fashion by x kPa/s.

When set to ‘**Flow**’ the pressure will increase in a non-linear fashion set by the manual flow control knob located on the right-hand side panel. This method is traditionally used to emulate the Messmer style machines traditionally used for Marks & Spencer and Adidas test methods.

Clamp Pressure (Range: 0 to 1000kPa)

This is a record of the amount of pressure used to clamp the specimen and is for information only.

Inflation Rate (Range: 1.0 to 100.0kPa/s)

Pressure Control Method: This sets the rate the diaphragm inflates at during the test. The “time to burst” (if active) will be shown in brackets e.g. [T=20s]. If your first specimen does not burst within the required time you will see a **Time?** key appear when the test stops. Pressing the **Time?** key will automatically adjust the inflation rate to achieve a burst in the correct amount of time. The “time to burst” parameter is set in Part 3 Standard Definition.

Flow Control Method: In this mode this setting is for information only and will be documented in the test results. Use the flow control knob on the right-hand side panel to manually adjust the inflation rate.

See the Flow Control Calibration, page 44.

Correction Rate (Range: 0 to 10.0kPa/s)

This sets the rate the diaphragm inflates at during diaphragm correction. Set it to maximum for automatic adjustment i.e. the correct rate for the test area and diaphragm in use. Set to 0 (zero) if no correction is required.

Burst Detection (Options: Off, Very Low, Low, Normal, High, Very High)

This feature will automatically stop the test if a burst is detected. Set to Off it not required. May need to be set higher for TruBurst³ to detect finer fabrics bursting.

Pressure Limit (Range: 0 to 1000.0kPa)

This sets the maximum pressure the specimen will be subjected to, typically used in a Pass/Fail type of test. Set to 0 (zero) if no limit is required.

Distension Limit (Range: 0 to 70.0mm)

This sets the maximum distension the specimen will be subjected to, typically used in a Pass/Fail type of test. Set to 0 (zero) if no limit is required.

Part 3 - Standard Definition

These parameters define the setting required by the test method.

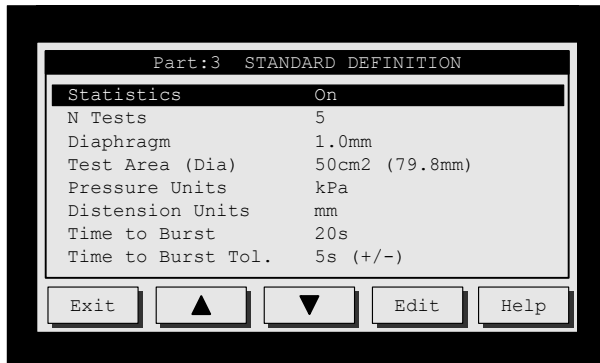

Exit takes you back to the previous screen	▲ and ▼ moves the highlight bar up or down	Edit lets you change the highlighted item	Help displays more information about selected item
---	--	--	---

Statistics (Options: Mean, Range, STD DEV, CV%, Q95%, Burst Index/Factor, %Decay)

Statistics can be selected from the list and appear on the test report.

N Tests (Range: 0 to 500 tests)

This is the number of tests to be performed. Test results are stored in memory until deleted, even if the instrument is switched off.

Diaphragm (Options: 0.15, 0.50, 1.0, 1.5mm)

This is the thickness of the diaphragm material in mm and appears on the test report. For optimum performance use only James Heal diaphragms.

Test Area (Dia)

(Options: 7.3, 7.8, 10, 50, 100 and 31.7cm²)

This is the size of the test area. **TruBurst³** automatically detects the test area you are using and will warn you if you attempt to carry out a test with an incorrect dome fitted.

Pressure Units

(Options: kPa, kg/cm², PSI, bar, kN/m²)

Pressure can be displayed in different units.

Distension Units (Options: mm, cm, inches)

Distension can be displayed in different units.

Time to Burst (Range: 0 to 300s)

This feature will automatically adjust the pressure inflation rate to enable a burst in the required time. Set to 0 (zero) for manual adjustment of the inflation rate.

Time to Burst Tol (Range: 0 to 10s)

This is the tolerance window of the Time to Burst feature. Set to 0 (zero) if not required.

Part 4 - Cyclic Definition

These parameters define the cyclic test method.

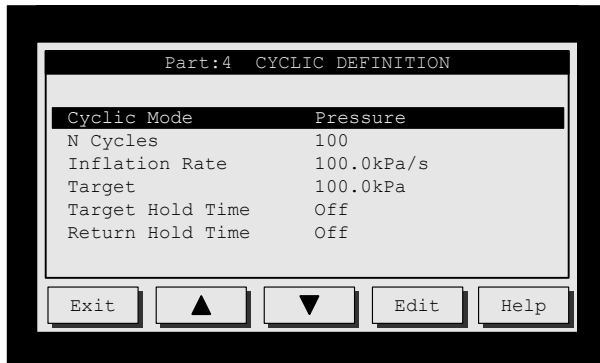

Exit takes you back to the previous screen	▲ and ▼ moves the highlight bar up or down	Edit lets you change the highlighted item	Help displays more information about selected item
---	--	--	---

Cyclic Definition

Each cycle consists of the following 4-phases:

- A = Inflation Rate
- B = Target Hold Time
- C = Deflation Rate
- D = Return Hold Time

The cycle can be repeated up to 500 times (N Cycles)

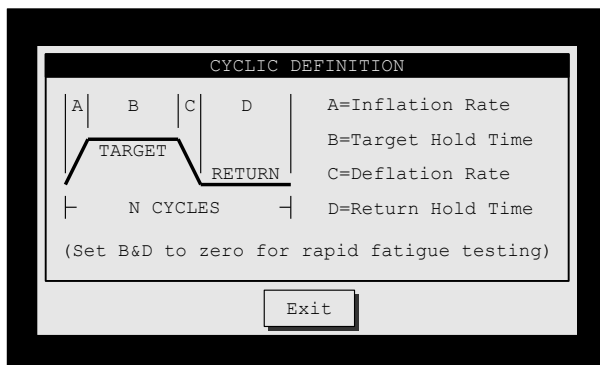

Cyclic Mode (Options: Off, Pressure, Distension)

TruBurst³ can perform repetitive cyclic tests rather than burst tests. You can cycle to a pressure or distension. Set this to Off if cyclic is not part of your Standard.

N Cycles (Range: 1 to 500 cycles)

This is the number of repetitive cycles a specimen will be cycled through.

Inflation Rate (A) (Range: 1.0 to 300 kPa/s)

This sets the rate the diaphragm inflates and deflates during the test. Use high values without hold times for rapid fatigue tests. Setting high inflation rates will cause a degree of overshoot in the target as the inflation rate increases every 0.1s.

Target (B) (Range: 0 to 1000kPa or 0 to 70mm)

This is the pressure or distension value you which to cycle to.

Target Hold Time (C) (Range: 0 to 300s)

Once the target (pressure or distension) is achieved use this parameter to maintain the target for a period of time. Set to 0 (zero) if no hold time is required.

Return Hold Time (D) (Range: 0 to 300s)

After deflation use this parameter to hold the specimen in a relaxed state for a period of time. Set to 0 (zero) if no hold time is required.

Did you know?

To program rapid fatigue testing cycles set the Target Hold (A) and Return Hold (B) times to zero. The diaphragm will rapidly discharge when the target has been achieved.

Consumables List

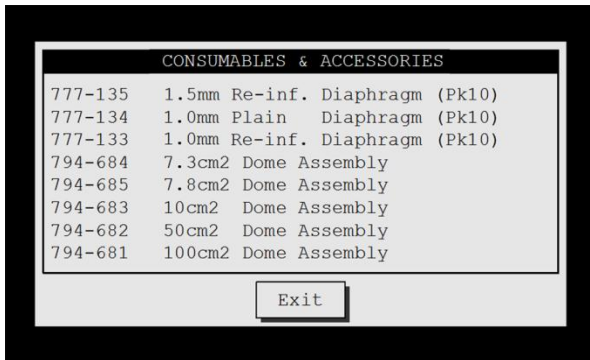

CONSUMABLES & ACCESSORIES	
777-135	1.5mm Re-inf. Diaphragm (PK10)
777-134	1.0mm Plain Diaphragm (PK10)
777-133	1.0mm Re-inf. Diaphragm (PK10)
794-684	7.3cm2 Dome Assembly
794-685	7.8cm2 Dome Assembly
794-683	10cm2 Dome Assembly
794-682	50cm2 Dome Assembly
794-681	100cm2 Dome Assembly

Exit

This is a list of frequently used Test Materials and Accessories. The six-digit prefix is the **James Heal** stock code followed by the item description.

Pressing Exit will return you to the Main Menu.

System Setup

From here you can set the system date and time, languages and other setup parameters.

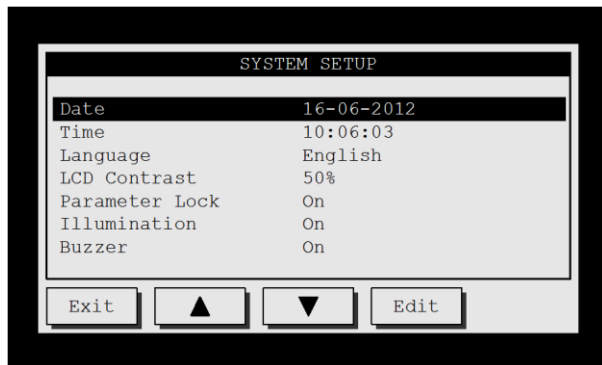

Exit takes you back to the previous screen	▲ and ▼ moves the highlight bar up or down	Edit lets you change the highlighted item
---	--	--

Did you know?

If the Parameter Lock is Off it will remind you to turn it On whenever you exit the “Select a Standard” menu.

Date (Format dd-mm-yyyy)

The date is displayed in day/month/year format. To edit the date, highlight the Date option and touch Edit. Use the **▲** and **▼** keys to change the day value. Subsequent presses of the Edit keys moves you to the month and year settings respectively. Press Edit to complete the change.

Time (Format hh:mm:ss)

The time is displayed in hours/minutes/seconds format. To edit the time, highlight the Time option and touch Edit. Use the **▲** and **▼** keys to change the hours value. Subsequent presses of the Edit keys moves you to the minutes and seconds settings respectively. Press Edit to complete the change.

Language

(Options: English, French, German, Spanish, Italian)

This is the language the screens and test reports appear in. There are 5 languages to choose from.

LCD Contrast (Range: 0 to 100%)

This adjusts the viewing angle/contrast of the LCD display. For best viewing, adjust the contrast when **TruBurst³** has been switched on for at least 10 minutes.

Parameter Lock (Options: Off, On)

When turned On, this lock prevents accidental editing of a Standards parameters.

Illumination (Options: Off, On)

The test area is illuminated by a low power long-life ultra-bright Light Emitting Diode (LED). Set it to Off if not required

Buzzer (Options: Off, On)

TruBurst³ emits a short beep whenever a key is pressed. Set it to Off if not required.

Machine Data

Machine Data lists important information about your instrument. This data is required whenever you require Service & Calibration or maintenance support.

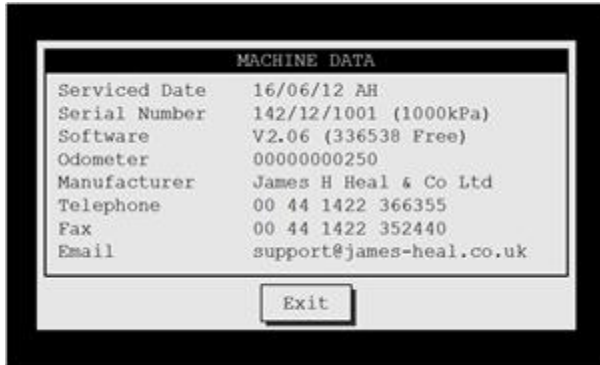

Serviced Data

This is the date the instrument was last serviced by a **James Heal** Service & Calibration engineer.

This will display --/--/-- if the instrument has not yet had a Service & Calibration service.

Serial Number

Serial number of the instrument and the pressure capacity.

Software

Software version number.

Odometer

This provides Service & Calibration engineers with information on the usage of the instrument.

Telephone

James Heal telephone number.

Fax

James Heal fax number.

Email

Service & Calibration service support Email address.

DATA LOGGER

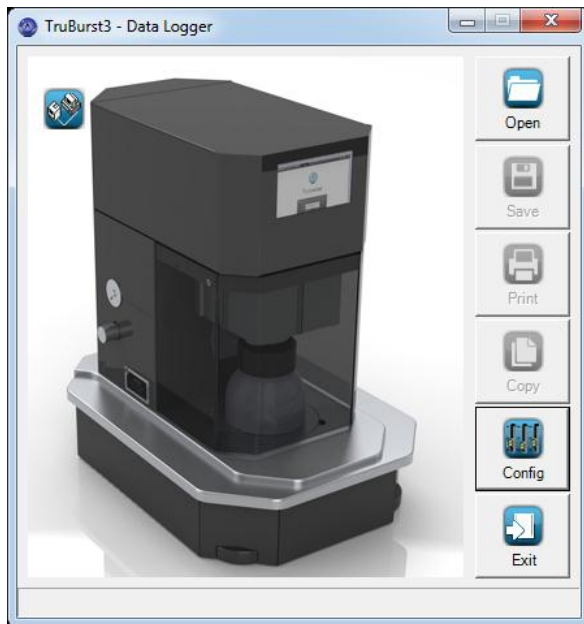

The TruBurst³ Data Logger software features:

- Automatic download, print and storage of test reports on your PC
- Provides tools to Recall, Edit, Save, Delete and Print stored test reports
- Provides drag & drop copying and copy to clipboard for pasting into other applications

Requirements:

- TruBurst³ Bursting Strength Tester
- TruBurst³ Data Logger software supplied on CD-ROM
- 9 way serial interface cable (D Type female-female null modem)
- A PC with a spare RS232 serial COM port running Windows XP/Vista/7 operating system.

Any PC capable of running one of the above mentioned Operating Systems will be sufficient for the requirements of the TruBurst³ Data Logger.

Connecting TruBurst³ to a PC

Hardware Connections

With the power off, connect one end of the serial interface cable to the 9-way D-type connector on the right of TruBurst³ and the other end to a spare COM port on your PC. Power up the PC then TruBurst³. If your computer does not have a 9-way D-type connector you can use a USB-to-Serial adaptor instead. See the Trouble Shooting section later in this guide.

Software Installation

Before running the set-up program which installs the TruBurst³ - Data Logger software, it is recommended to exit all other programs. Insert the CD into your DVD/CD-ROM drive. The set-up program will start the installation wizard, which will guide you through the set-up procedure. If the set-up program does not start automatically, click the Windows 'START' button then choose 'RUN...' and type "D:\Setup.exe" assuming that 'D' is the drive letter for your DVD/CD-ROM.

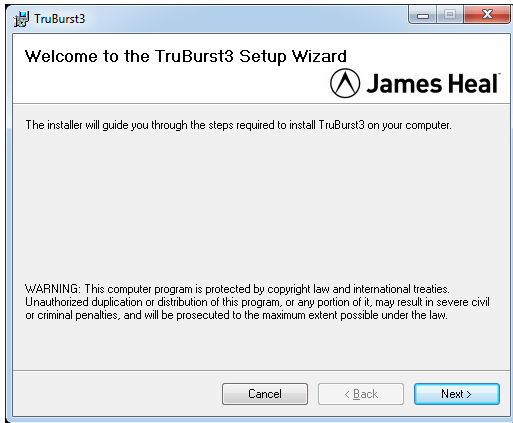

Installation Wizard

Place the CD in the DVD/CD drive on your PC. The CD will auto-run.

Follow and accept the default prompts.

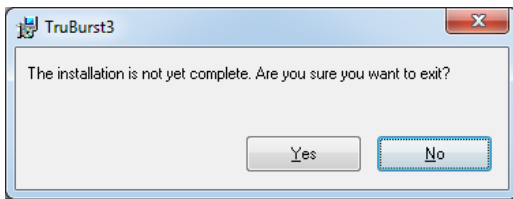

To cancel the installation at any time press "Cancel".

You will be prompted with "are you sure ?"

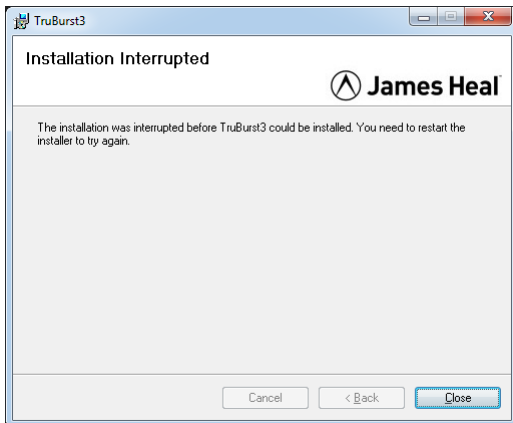

If you answer "yes" the installation will be aborted.

If you answer "No" the installation will continue.

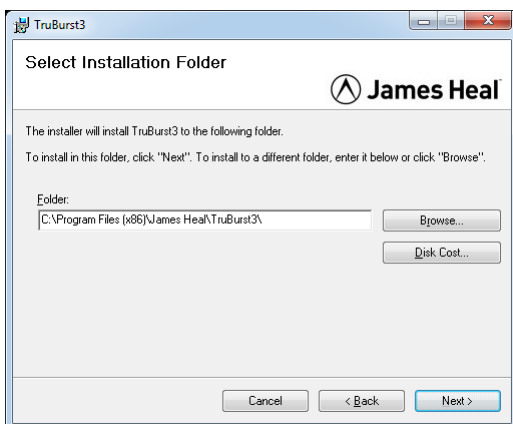

It is recommended to accept the default folder for installation.

Due to Windows security policies, if you select an alternative folder, the installation may fail.

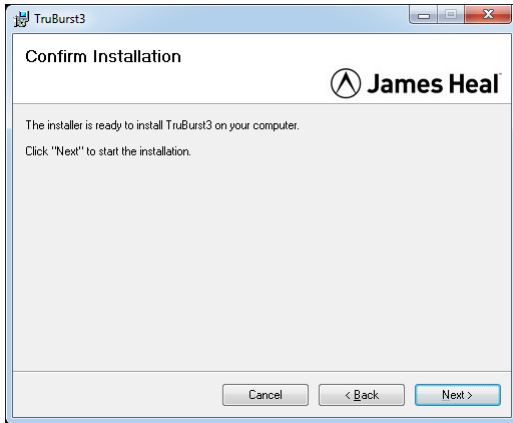

Click “Next” to start the installation.

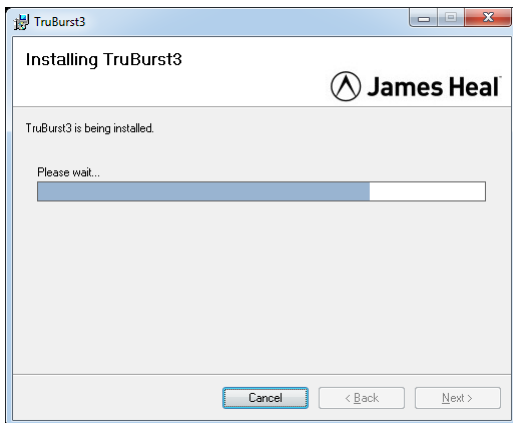

The installation progress is displayed.

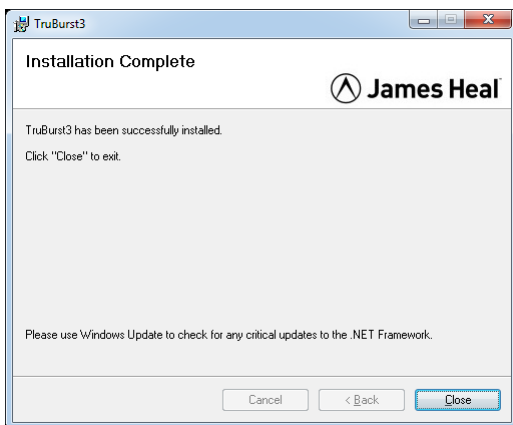

The installation has completed.

Click “Close”.



To start the Data Logger, double click the **TruBurst³** icon on your desktop.

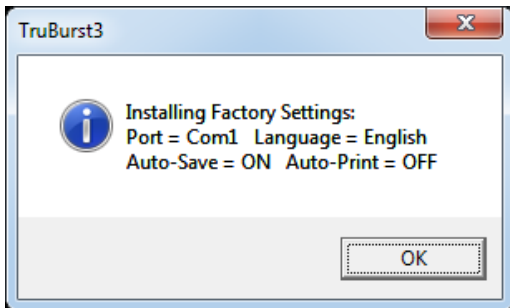

When the application is first run, you will be prompted with this message.

These are the factory settings but they can easily be changed by selecting the **Config** button.

Click “OK”.



Configuring the Software

The icons on the left indicate the status of the connection to **TruBurst³**. If you have a **bad connection** click the **Config** button and select a different COM Port.

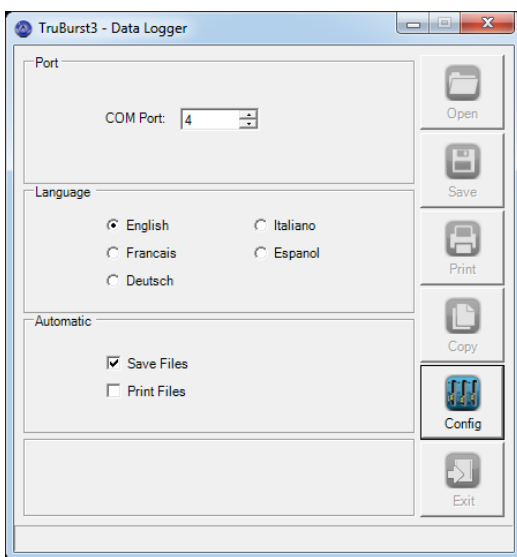
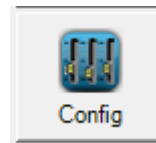

Port

It is very important to select the correct COM Port for communication with **TruBurst³**. The connection icon in the top left-hand corner of the start screen indicates when you have selected the correct communications port and have a Good Connection.

An error message “Run time error: 8002 Invalid Port Number” may be displayed if your computer does not support the selected port. See Trouble Shooting section later if you receive this error message.

Language

Clicking on any of the language options instantly changes the on-screen text to the chosen language.

Save Files

Tick this option if you want Data Logger to automatically save a test document when it is received from **TruBurst³**. Data Logger will automatically assign a unique filename based on the document reference number.

Print Files

Tick this option if you want Data Logger to automatically print out each test report as it arrives from **TruBurst³**.

Operating TruBurst³ Data Logger

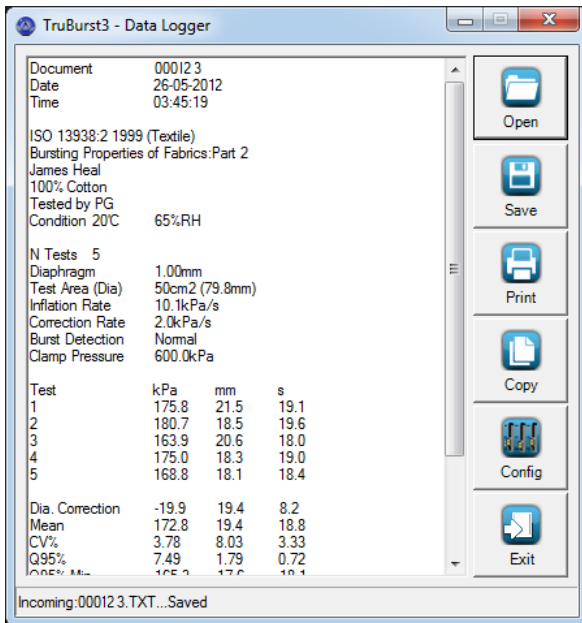

With the software configured you are now ready to receive test documents from TruBurst³. Data Logger is designed to run as a background task, constantly monitoring a COM port waiting for data from TruBurst³. When data arrives at the port, it is displayed on the screen and automatically saved and printed if required.

Original files are saved as read-only so you will always have a master copy that has not been altered in any way. Each file is given a unique 6-digit document number, for example, 000123.txt

Sending Data to the Data Logger

When the test results are shown on the TruBurst³ screen, press the Specimen Data key on the TruBurst³ instrument and fill in the Specimen Data. Then press the EXPORT key to send the data to the Data Logger.

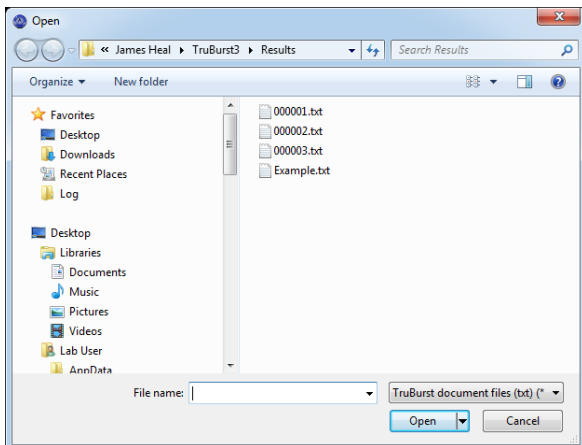

Open a Document

Saved test documents can be recalled by using the Open button. Users who are familiar with using Windows will recognise the common dialogue box functions on this screen. From here you can select and look in folders on different drives and networks. Create new folders and list files by name/date. It is also possible to delete individual files by highlighting the file and pressing the delete key.

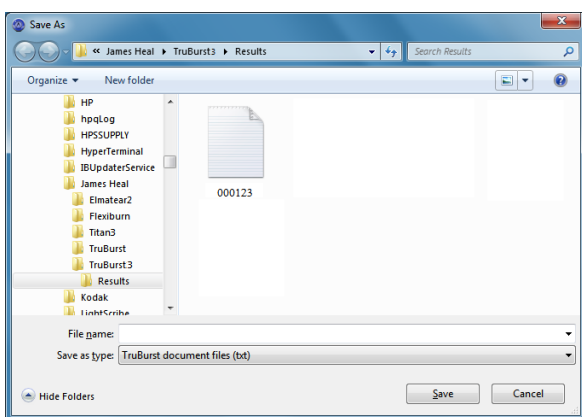
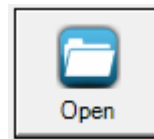

Saving a Document

After opening or editing a file you may wish to save the test document with a different filename. You will be prompted if you attempt to save a document with a filename that already exists.

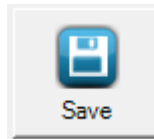

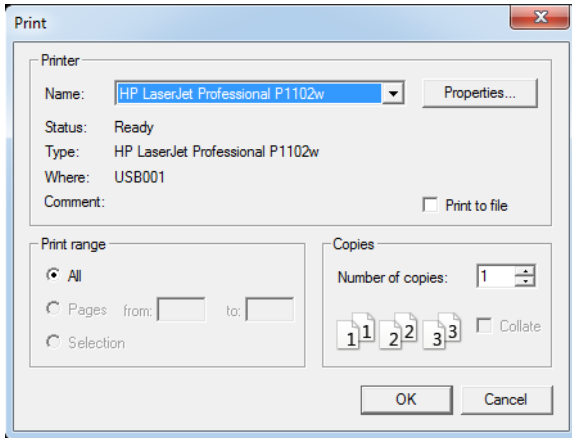

Printing a Document

After opening or editing a file you may wish to print the test document. Users who are familiar with using Windows will recognise the common dialogue box functions on this screen. From here you can select a local or network printer and the number of copies you require.



Copying Text From the Document

Test documents are displayed and saved in Rich Text Format (RTF). Data Logger has been designed to allow you to copy text to the clipboard for subsequent pasting into another application like a word processor, or for drag and drop pasting. To copy-to-clipboard simply highlight the text with the mouse and press the **Copy** button. Go to the required application and select Paste from the Edit menu or use the Ctrl-V shortcut. Always use a proportionally spaced font such as Courier New to maintain the format of the test document or use drag-and-drop copying which will do this automatically for you. For drag-and-drop copying, simply highlight the text, then drag and drop the highlighted text onto the required application.

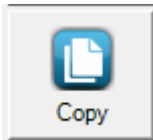

Exit

Exit quits the TruBurst³ Data Logger without prompting.

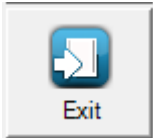

TROUBLE SHOOTING

Connecting TruBurst³ to a Personal Computer

If you see this COM error message while in the Configuration page, use the up/down arrows (shown in the red square below) in the Port/ Com Port section to find and select an available COM Port.

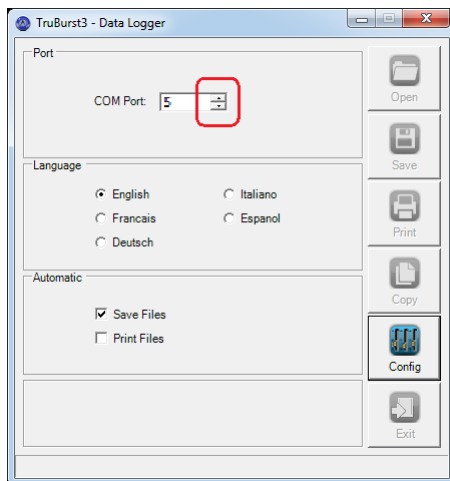
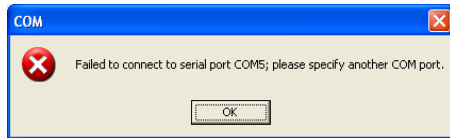

The Data Logger software allows you to select ports COM1 to COM12 to communicate with TruBurst³. When using a USB-to-Serial adaptor, Windows may assign it a COM Port number greater than COM12.

If you are having difficulty communicating with TruBurst³ your USB-to-Serial adaptor may require configuring to use COM1 to COM12. This can be done in Windows, select:

- Start
- Control Panel
- System
- Hardware
- Device Manager
- Ports (COM & LPT)

Select your USB-to-Serial device from the list and double-click it to display its properties.

Select the Port Setting Tab - Advanced and select a port between COM1 and COM12 from the drop down box. Your USB-to-Serial adaptor is now configured.

Now configure the Data Logger software by clicking its “Config” button and selecting your chosen COM Port.

ELECTRICAL WIRING SCHEMATIC

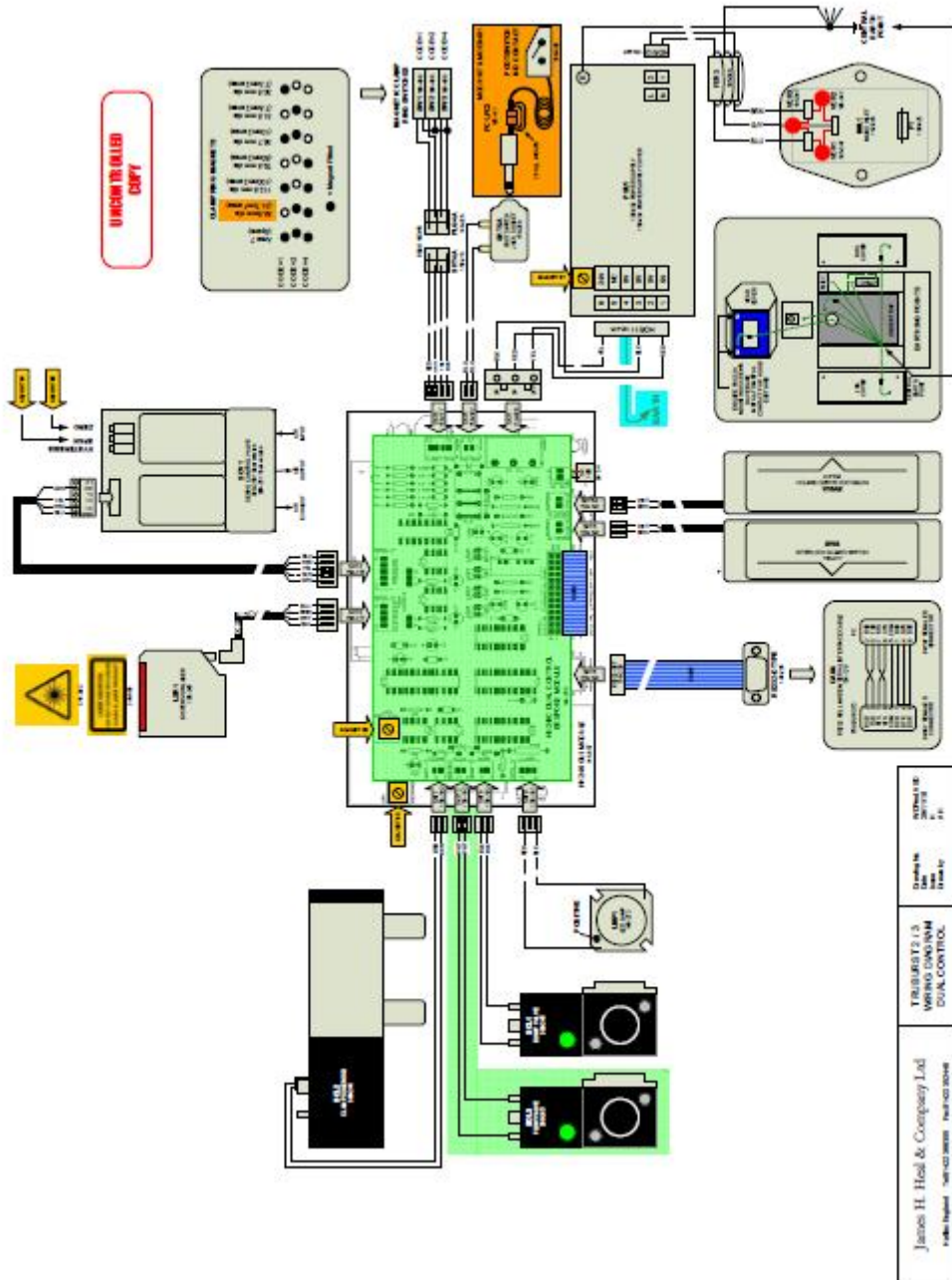

PRODUCT SAFETY

The TruBurst³ Models 140 and 142 are CE marked and comply with the following International and European requirements of :

Machinery Directive (98/37/EC)	Implemented in the UK through the following: - Supply of Machinery (Safety) Regulations 1992 (SI 1992 No. 3073) Supply of Machinery (Safety) (Amendment) Regulations 1994 (SI 1994 No. 2063)
Low Voltage Directive (2006/95/EC)	Implemented in the UK through the following: - Electrical Equipment (Safety) Regulations 1994 (SI 1994 No. 3260)
Electromagnetic Compatibility Directive (89/336/EEC)	As amended by Directive 92/31/EEC Implemented in the UK through the following: - Electromagnetic Compatibility Regulations 1992 (SI 1992 No. 2372) Electromagnetic Compatibility (Amendment) Regulations 1994 (SI 1994 No. 3080) Electromagnetic Compatibility (Amendment) Regulations 1995 (SI 1995 No. 3180)
Safety of Laser Products Part 1 (IEC 60825-1:2001)	Equipment classification, requirements and user's guide'

WARNING: A Class 2 laser is used to make non-contact measurements of the distension from the underside of the diaphragm. Do not stare into the beam.



FLOW CONTROL CALIBRATION

Calibration of the James Heal TruBurst³ (M&S P27 and Adidas 4.09)

1. Check that the supply pressure from the compressor is 6 ± 0.2 bar. (600 ± 20 kPa or 87 ± 3 PSI).
2. Ensure the Perspex Guard is in place.
The instrument will not operate if it is not.
3. Lower the Test Dome (clamp bell) and check that the Clamp Pressure Gauge is 420 kPa (61psi). The Clamp Pressure Gauge is located on the left hand side of the instrument. If it is not then adjust the control knob next to the gauge to adjust and then re-check.
4. From the instrument display, choose Select Standard and then select M&S P27 (Fabric, 50 cm² Test Dome), M&S P27 (Lace, 7.3 cm² Test Dome) or Adidas 4.09 (50 cm² Test Dome).
5. Check the testing pressure rate by placing the Metal Plate between the Test Dome and the Clamp Ring / Diaphragm. Ensure the Perspex Guard is in place.
6. From the display press the Clamp key and the Test Dome will move down. The CAL button only appears on Dual Control instruments when a Standard is using “Flow Control” on Test No.1.

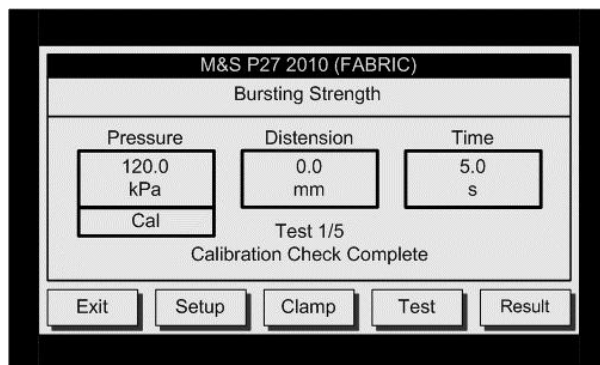

7. To use this feature; select a Standard that uses “Flow Control”, then fit and clamp a blanking plate, then press the CAL button.
8. The instrument will automatically stop after 5 seconds and display the pressure achieved. Ensure rate is 120 kPa in 5s (24 ± 1 kPa/s) for Fabrics OR is 225 kPa in 5s (45 ± 1 kPa/s) for Lace.
9. If the pressure rate requires adjustment, use the Flow Control Valve on the right hand side of the instrument. This is a sensitive needle valve used to control the flow of compressed air.

If the instrument is not working check the following :

- The Perspex Safety Guard is in place.
- The correct Test Dome is fitted.
- The compressed air supply is connected correctly.
- The O-ring below Clamp Ring / Diaphragm is fitted.
- Diaphragm is not damaged / leaking.

M&S P27 and Adidas 4.09 capability is available as standard on **TruBurst³** model 142 and **TruBurst²** model 810/DC.

The Dual Control option can be retro fitted to **TruBurst³** model 140 and **TruBurst²** (Model 810 only) but is not available on the **TruBurst 600** series.

Only use the 777-134 Plain Diaphragm (1mm) pack 10 for M&S and Adidas test methods. These are **green** in colour to differentiate them from the reinforced varieties, which are **blue**.

TECHNICAL DATA

COMPRESSED AIR	Free air delivery	33	l/min
	Maximum pressure	10	bar
		145	psi
	Minimum pressure	6	bar
	Filtration	≤5	micron

PRESSURE RANGE	10 bar Subject to suitable air supply		
	Accuracy +/- 0.5% of full scale		
	0.2	-	1000.0 kPa
	0.002	-	10.197 kg/cm ²
	0.04	-	145.04 PSI
	0.002	-	10.000 bar
	0.2	-	1000.0 kN/m ²

PRESSURE INFLATION RATE	0.1	-	100.0 kPa/s
	0.002	-	1.020 kg/cm ² /s
	0.04	-	14.50 PSI/s
	0.002	-	1.000 bar/s
	0.2	-	100.0 kN/m ² /s

DISTENSION RANGE	Non-contact Class 2 laser measurement		
	Accuracy +/- 0.5% of full scale		
	0.1	-	70.0 mm
	0.01	-	7.00 cm
	0.001	-	2.756 inches

SPECIMEN	Area	Diameter	Height
	7.3cm ²	30.5mm	30mm
	7.8cm ²	31.5mm	30mm
	10cm ²	35.7mm	30mm
	50cm ²	79.8mm	70mm
	100cm ²	112.8mm	70mm

STATISTICS Mean, maximum, minimum, range, standard deviation, coefficient of variation, 95% confidence limits, burst factor/index and %decay analysis for up to 500 tests

SERIAL INTERFACE RS232 9-way male 'D' type connector
38400-baud, 8-data bits, 1-stop bit, no parity
Data logger software supplied on CD-ROM for PC

DIMENSIONS 400mm x 550mm x 580mm (width depth height)

WEIGHT 90kg

ELECTRICAL Single Phase 90-264Vac 50-60Hz 40W max

REVISION HISTORY

See front cover for Publication number, e.g., 290-142-1\$A.

Rev	Date	Originator	Details of revision
A	08-05-12	PG	New release
B	20-11-12	PG	Flow Control Calibration updated for V2.7 Firmware