



Electric Boilerless Roll-In Combi with  
Touchscreen Control

# CLBKI-202E

The CLBKI-202E roll-in combi offers an ideal meal capacity of 300-500 meals.

**Exceptional Design for Exceptional Kitchens** - the BKI Combi is characterized by quality and simplicity. It has a unique ability to combine form and function; beauty and functionality effortlessly blends together. It enables you to reach perfection every time and with every meal.

**Cook the way you want** - the BKI Combi touchscreen control lets you choose which kind of chef you want to be. You can cook manually and easily fine-tune your settings. Use pre-programmed recipes to ensure consistent results every time. Or use the SmartChef feature which automatically selects the optimum settings for an effortless cooking process.



## CAPACITY

- ❑ Standard transport cart with 3.35" (85mm) spacing holds fifteen full size sheet pans or thirty 12" x 20" x 2-1/2" deep North American hotel pans
- ❑ Optional transport cart with 2.64" (67mm) spacing holds twenty full size sheet pans or forty 12" x 20" x 2" deep Gastronorm pans

## STANDARD FEATURES

- External detachable core temperature probe with multiple measuring points. User friendly location reduces strain on the probe
- Transport cart with 3.35" (85mm) spacing
- Rack support platform
- Bright halogen lights for superior visibility
- Built in external hand shower
- Removeable cleaning chemical bottle shelf
- 15 wire shelves
- Adjustable feet
- Left door hinge
- Start-up inspection service by factory authorized service agent.
- One year parts and labor oven warranty\*

\* For all international markets, contact your local distributor.

[www.bkideas.com](http://www.bkideas.com)

42 Allen Martin Drive, Essex Junction, VT 05452 • Phone: (802) 658-6600 • Fax: (802) 864-0183

P/N 63329 Rev B (3/21)

## OPTIONS & ACCESSORIES

### (AT ADDITIONAL CHARGE)

#### ■ Banqueting Accessories

- Pan cassette with 2.64" (67mm) spacing
- Pan cassette with 3.35" (85mm) spacing
- Plate cassette with 2.64" (67mm) spacing holds 117 plates
- Plate cassette with 3.35" (85mm) spacing holds 99 plates
- Transport trolley, to move the cassette
- Insulated thermal blanket with vent
- Additional core probe
- Side heat shield
- Extra wire oven racks
- Additional transport cart
- Backflow preventer
- Extra year warranty

### (AT NO ADDITIONAL CHARGE)

- Optional cart w/ 2.64" (67mm) spacing & 20 wire shelves in lieu of standard cart & shelves

## OVEN OPERATION

- Injection steam system - water is injected onto the heating elements, the resulting steam is distributed in the oven chamber by the fan wheel.
- Easy to use touchscreen control stores up to 500 recipes with up to 15 steps each
- Multiple cooking modes include hot air, CombiSmart, retherm, steaming, low-temperature steaming, forced steaming, proofing, preheating
- CombiOptima automatically measures and controls the humidity level in the oven
- SmartChef automatic cooking provides presets for grilling, steaming, braising, browning and breaded products. Select your desired cooking result from rare to well done, and your surface appearance from light to dark.
- Manual or automatic cooling
- Automatic humidity pulsing
- Timed steam injection or instant steam on demand at any point in the cook cycle
- Rack timing for setting individual timers for each rack
- Advanced rack timing for managing multiple recipes of the same group simultaneously on separate racks, including managing recipes to finish cooking at the same time
- Reversible 9 speed fan for optimum baking and roasting results
- Programmable vent release allows for automatic venting if desired
- USB port for data and recipe transfer
- HACCP recording and documentation
- Automated CombiWash system features very low water and detergent consumption and no contact with chemicals. No proprietary chemicals required, see owner's manual for detergent guidelines.



## CONSTRUCTION

- 304 stainless steel exterior and interior
- Dual pane tempered viewing window with hinged inner glass for easy cleaning
- 2" (50mm) fixed drain in the bottom center of cavity
- Door mounted stainless steel drip tray reduces the risk of wet floors
- Separate water lines, for cooking and quench
- Automatic safety door stops in positions 110° and 180°
- Left hinge door is field convertible to the right side (with the purchase of conversion kit)
- Two step safety door latch. The first step stops the fan.

**SHORT FORM SPECIFICATIONS:** Provide BKI Combi model CLBKI-202E electric boilerless roll-in combination-oven/steamer. The CLBKI-202E has a transport cart with 3.35" (85mm) spacing holds fifteen full size sheet pans or thirty 12" x 20" x 2-1/2". The optional transport cart with 2.64" (67mm) spacing holds twenty full size sheet pans or forty 12" x 20" x 2" deep Gastronorm pans.

Unit has a 304 stainless steel exterior and interior. Oven door has a dual pane tempered viewing window with hinged inner glass for easy cleaning. Includes a built in external hand shower and separate water lines. Unit shall have bright halogen lights for superior visibility and an external detachable core temperature probe. Oven has two separate water lines for cooking and quench. You may choose to cook with pressureless steam, hot air, or combination of steam and hot air.

The touchscreen control stores 500 recipes with 15 stages each, in addition to pre-programmed recipes. Multiple modes include hot air, combi, retherming, steaming, low-temperature steaming, forced steaming, proofing, cooling, and preheating. CombiOptima automatically measures and controls the humidity level in the oven. The control allows for timed steam injection or instant steam on demand at any point in the cook cycle. Rack timing provides individual timers for each rack. Advanced rack timing allows for timing multiple recipes of the same group simultaneously on separate racks of the oven. Use SmartChef automatic cooking presets for grilling, steaming, braising, browning and breaded products. HACCP quality control, USB connectivity and automatic service diagnosis are included. Programmable vent release allows for automatic venting if desired. The reversible 9 speed fan provides optimum baking and roasting results. The automated combi wash system features very low water and detergent consumption and no contact with chemicals.

Includes one-year parts and labor warranty. Provide start-up inspection service by a factory authorized service agent. Provide options and accessories as indicated.

*NOTE: The company reserves the right to make substitutions of components without prior notice.*



## POWER SUPPLY

VOLTAGE	KW	PHASE	AMPERAGE
208 VAC	60	3 PH	167 amp
240 VAC	60	3 PH	145 amp
480 VAC	60	3 PH	73 amp

Other voltages available, contact factory

This appliance uses a variable frequency drive, which can be known to product high frequency electrical noise. In some cases units must be hard wired. This avoids false positives on ground fault devices susceptible to errors from electrical noise. All installations must comply with local and national codes.

## WATER SUPPLY

Good quality water feed is the responsibility of the owner. Water quality must be within the following general guidelines.

TDS: 40-125 ppm	pH: 7.0 - 8.5
Hardness: 35-180 ppm	Silica: <13 ppm
Chloramine: <0.2 ppm	Chlorine: <0.2 ppm
Chlorides: <25 ppm	

The best defense against poor water quality is a water treatment system designed to meet your water quality conditions. BKI offers optional water treatment systems.

### Pressure

- 40 (min)-50 (max) PSI

### Connections

- 2" drain connection - max. drain temperature 140°F (60°C)
- 3/4" garden hose cold water





## DRAIN

The drain piping must consist of temperature resistant material, greater than 160°F, and be of adequate diameter not to cause flow restriction. Improper materials may deform and cause restrictions, thus affecting performance.

Appliance is to be installed with backflow protection in accordance with federal, state or local codes.

DIMENSIONS ARE IN INCHES (MM)

**LEGEND**

-  FILTERED WATER
-  UNFILTERED WATER
-  DRAIN
-  ELECTRICAL
-  VENT

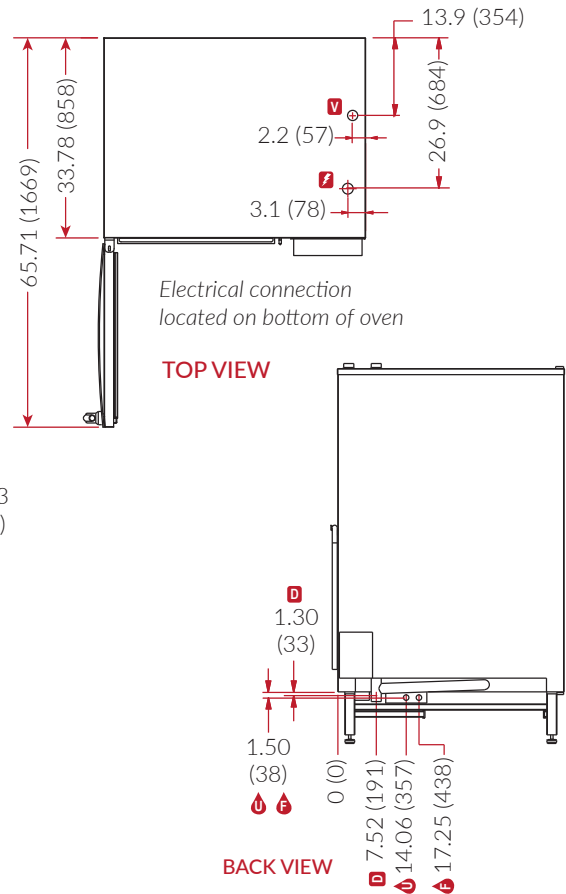
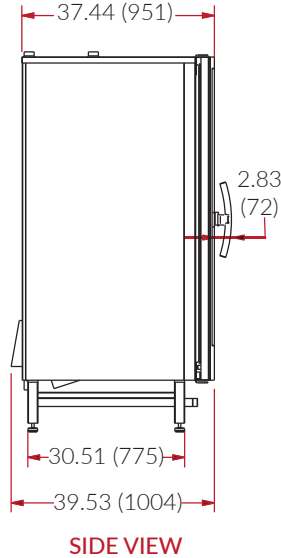
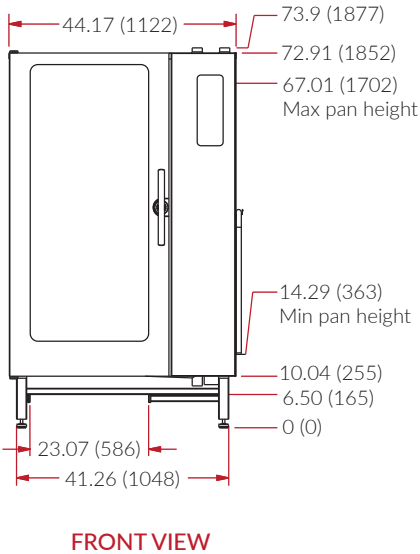

**SHIPPING**

**WEIGHT**

Oven & Cart 796 lbs (361 kg)

**CRATE SIZE**

Oven & Cart 81" H x 49" W x 41" D  
(2057 x 1245 x 1041 mm)

**DIMENSIONS & CLEARANCES**

**FLOOR SPACE**

44.17" x 37.44" (1122 x 951mm)

**UNIT HEIGHT**

Oven 73.9" (1877mm)

**MINIMUM ENTRY CLEARANCES (per section)**

Uncrated 37.47" (951mm)  
Crated 41" (1041mm)

**OVEN INSTALLATION CLEARANCE REQUIREMENTS**

Kitchen Environment	Low temp.	High temp.*
Left Side & Back	2" (50mm)	2" (50mm)
Right (control) Side	2.8" (70mm)	16" (400mm)

\* includes heat sources (fryers, hot plates, etc) placed on the control side of the combi

For servicing, BKI recommends maintaining at least 16" (400 mm) between the control side and walls or non moveable equipment.

