



Electric Pass-Through Combi
with Touchscreen Control

CBKI-61E-PT

The CBKI-61E-PT offers an ideal meal capacity of 30 - 80 meals.

AVOID CROSS CONTAMINATION

The 2-door oven solution PassThrough to improve logistics in your kitchen and save time. If you place the PassThrough oven between the kitchen and the serving area, the oven can be loaded from the kitchen side and unloaded from the opposite side when the products are ready. This way, you form a sharp separation between the products to be cooked and the products already cooked - thus preventing cross contamination, for example when you handle poultry.

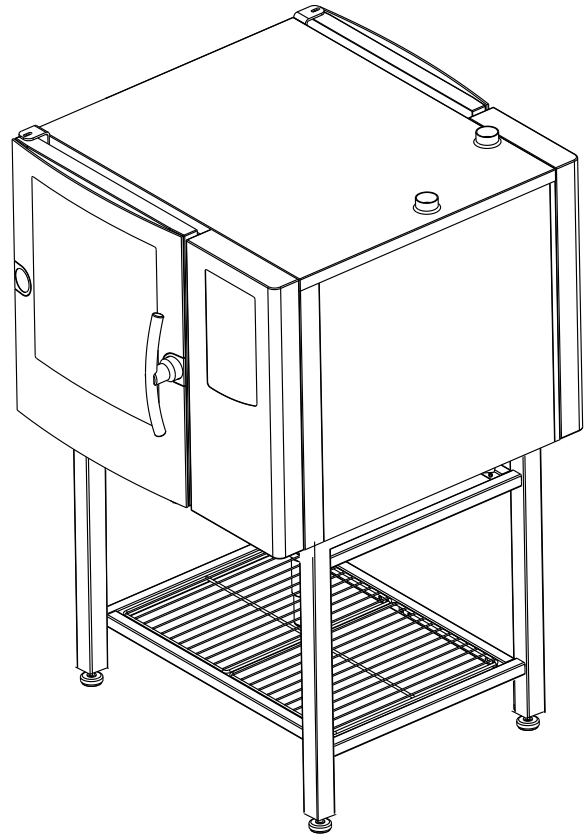

CAPACITY

- ❑ Standard pan cassette with 3.35" (85mm) spacing holds five half size sheet pans or five 12" x 20" x 2-1/2" deep North American hotel pans
- ❑ Optional pan cassette with 2.56" (65mm) spacing holds six half size sheet pans or six 12" x 20" x 2" deep Gastronorm

STANDARD FEATURES

- External detachable core temperature probe with multiple measuring points. User friendly location reduces strain on the probe
- 31-1/2" tall stainless steel stand with casters
- Bright halogen lights for superior visibility
- Built in external hand shower
- Removeable cleaning chemical bottle shelf
- 5 wire shelves
- Left door hinge, field reversible with purchase of kit
- Start-up inspection service by factory authorized service agent.
- One year parts and labor oven warranty*

* For all international markets, contact your local distributor.

www.bkideas.com

42 Allen Martin Drive, Essex Junction, VT 05452 • Phone: (802) 658-6600 • Fax: (802) 864-0183

P/N 63270 Rev B (3/21)

OPTIONS & ACCESSORIES

(AT ADDITIONAL CHARGE)

■ Legs and Stands

- 31-1/2" tall stainless steel stand with runners & casters
- Adjustable feet for table top installation

■ Banqueting Accessories

- Pan cassette with 2.56" (65mm) spacing
- Pan cassette with 3.35" (85mm) spacing
- Plate cassette with 2.56" (65mm) spacing holds 20 plates
- Plate cassette with 3.35" (85mm) spacing holds 15 plates
- Cassette support platform
- Transport trolley, to move the cassette
- Insulated thermal blanket with vent
- Additional core temperature probe
- Heat shield
- Extra wire oven racks
- Right hinge door
- Backflow preventer
- Extra year warranty

(AT NO ADDITIONAL CHARGE)

- Optional rack w/ 2.56" (65mm) spacing & 6 wire shelves in lieu of standard rack & shelves

OVEN OPERATION

- Built in steam generator produces pure, dry steam
- Easy to use touchscreen control stores up to 500 recipes with up to 15 steps each
- Multiple cooking modes include hot air, CombiSmart, retherm, steaming, low-temperature steaming, forced steaming, proofing, preheating
- CombiOptima automatically measures and controls the humidity level in the oven
- SmartChef automatic cooking provides presets for grilling, steaming, braising, browning and breaded products. Select your desired cooking result from rare to well done, and your surface appearance from light to dark.
- Manual or automatic cooking
- Automatic humidity pulsing
- Timed steam injection or instant steam on demand at any point in the cook cycle
- Rack timing for setting individual timers for each rack
- Advanced rack timing for managing multiple recipes of the same group simultaneously on separate racks, including managing recipes to finish cooking at the same time
- Reversible 9 speed fan for optimum baking and roasting results
- Programmable vent release allows for automatic venting if desired
- USB port for data and recipe transfer
- HACCP recording and documentation
- Automated CombiWash system features very low water and detergent consumption and no contact with chemicals. No proprietary chemicals required, see owner's manual for detergent guidelines.
- Automatic deliming system



CONSTRUCTION

- 304 stainless steel exterior and interior
- Dual pane tempered viewing window with hinged inner glass for easy cleaning
- 2" (50mm) fixed drain in the bottom center of cavity
- Door mounted stainless steel drip tray reduces the risk of wet floors
- Separate water lines, for cooking and quench
- Automatic safety door stops in positions 110° and 180°
- Left hinge door is field convertible to the right side (with the purchase of conversion kit)
- Two step safety door latch. The first step stops the fan.

SHORT FORM SPECIFICATIONS: Provide BKI Combi model CBKI-61E-PT pass-through combination-oven/steamer. The CBKI-61E-PT has a 2 piece rack system with 3.35" (85mm) spacing that holds five 12" x 20" x 2-1/2" deep North American hotel pans. The optional 2 piece rack system with 2.5" (65mm) spacing holds six 12" x 20" x 2" deep Gastronorm pans.

Unit has a 304 stainless steel exterior and interior. This pass-through model has two doors on both the front and back. Each door shall have dual pane tempered viewing windows with hinged inner glass for easy cleaning. Includes a built in external hand shower and separate water lines. Unit shall have bright halogen lights for superior visibility and an external detachable core temperature probe. Oven has two separate water lines for cooking and quench. You may choose to cook with pressureless steam, hot air, or combination of steam and hot air.

The touchscreen control stores 500 recipes with 15 stages each, in addition to pre-programmed recipes. Multiple modes include hot air, combi, retherming, steaming, low-temperature steaming, forced steaming, proofing, cooling, and preheating. CombiOptima automatically measures and controls the humidity level in the oven. The control allows for timed steam injection or instant steam on demand at any point in the cook cycle. Rack timing provides individual timers for each rack. Advanced rack timing allows for timing multiple recipes of the same group simultaneously on separate racks of the oven. Use SmartChef automatic cooking presets for grilling, steaming, braising, browning and breaded products. HACCP quality control, USB connectivity and automatic service diagnosis are included. Programmable vent release allows for automatic venting if desired. The reversible 9 speed fan provides optimum baking and roasting results. The automated combi wash system features very low water and detergent consumption and no contact with chemicals.

Includes one-year parts and labor warranty. Provide start-up inspection service by a factory authorized service agent. Provide options and accessories as indicated.

NOTE: The company reserves the right to make substitutions of components without prior notice.



POWER SUPPLY

VOLTAGE	KW	PHASE	AMPERAGE
208 VAC	9	3 Ph	25 amp
240 VAC	9	3 Ph	22 amp
480 VAC	9	3 Ph	11 amp

Other voltage available, contact factory.

This appliance uses a variable frequency drive, which can be known to produce high frequency electrical noise. In some cases units must be hard wired. This avoids false positives on ground fault devices susceptible to errors from electrical noise. All installations must comply with local and national codes.

WATER SUPPLY

Good quality water feed is the responsibility of the owner. Water quality must be within the following general guidelines.

TDS: 40-125 ppm	pH: 7.0 - 8.5
Hardness: 35-180 ppm	Silica: <13 ppm
Chloramine: <0.2 ppm	Chlorine: <0.2 ppm
Chlorides: <25 ppm	

The best defense against poor water quality is a water treatment system designed to meet your water quality conditions. BKI offers optional water treatment systems.

Pressure

- 40 (min)-50 (max) PSI

Connections

- 2" drain connection - max. drain temperature 140°F (60°C)
- 3/4" garden hose cold water





DRAIN

The drain piping must consist of temperature resistant material, greater than 160°F, and be of adequate diameter not to cause flow restriction. Improper materials may deform and cause restrictions, thus affecting performance.

Appliance is to be installed with backflow protection in accordance with federal, state or local codes.

DIMENSIONS ARE IN INCHES (MM)

LEGEND

-  FILTERED WATER
-  UNFILTERED WATER
-  DRAIN
-  ELECTRICAL
-  VENT

TOP VIEW

All connections are located on the bottom of the ovens.

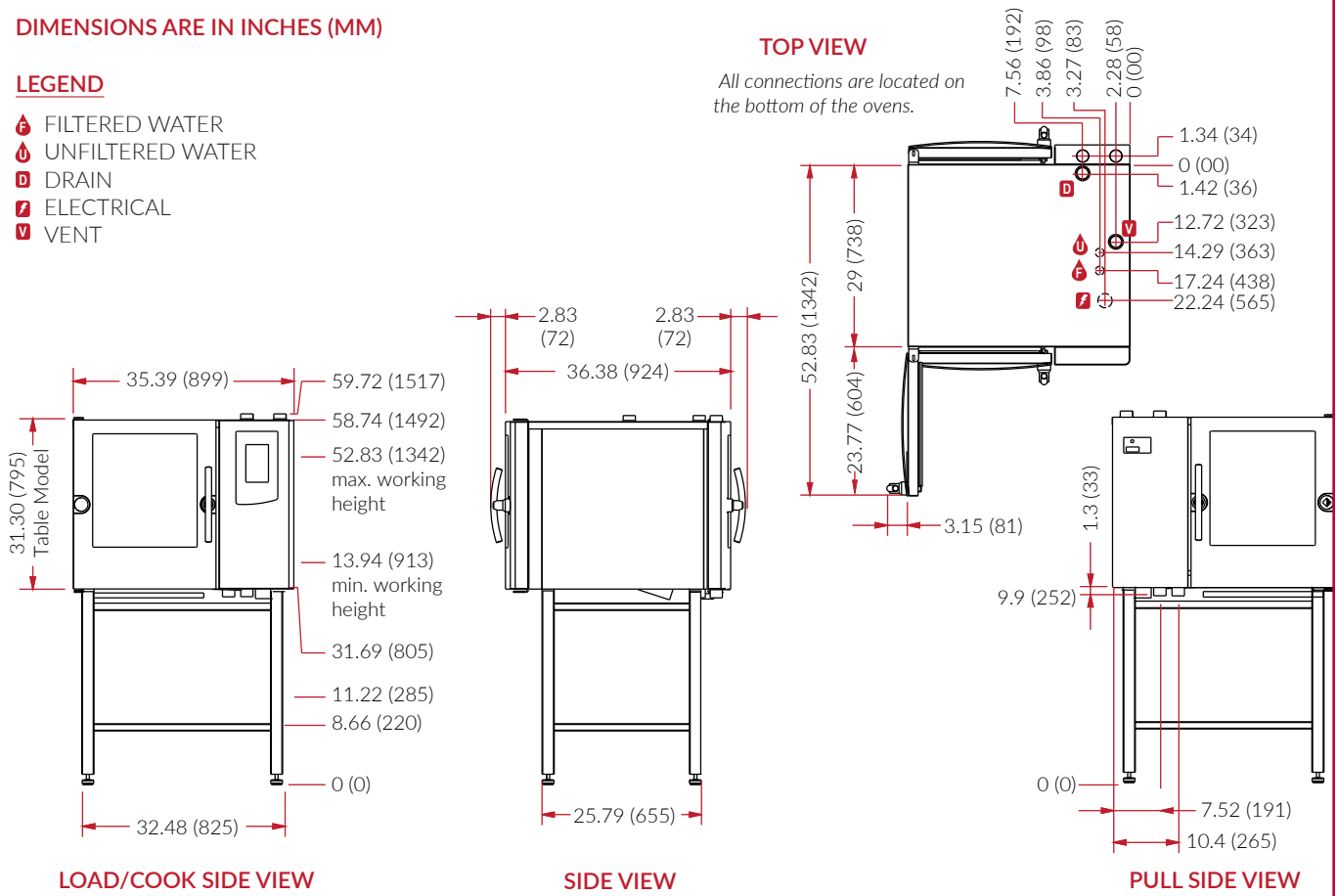

SHIPPING

WEIGHT

435 lbs (197 kg)

CRATE SIZE

- Oven 40" H x 47" W x 38" D (1016 x 1194 x 965 mm)
- Stand 36" H x 42" W x 35" D (914 x 1067 x 889 mm)

DIMENSIONS & CLEARANCES

FLOOR SPACE

35.39" x 36.39" (899 x 924mm)

UNIT HEIGHT

- On standard stand 58.74" (1492mm)
- Table model 31.30" (795mm)

MINIMUM ENTRY CLEARANCES (per section)

- Uncrated 29.06" (738mm)
- Crated 38" (965mm)

OVEN INSTALLATION CLEARANCE REQUIREMENTS

Kitchen Environment	Low temp.	High temp.*
Left Side & Back	2" (50mm)	2" (50mm)
Right (control) Side	2.8" (70mm)	16" (400mm)

* includes heat sources (fryers, hot plates, etc) placed on the control side of the combi

For servicing, BKI recommends maintaining at least 16" (400 mm) between the control side and walls or non moveable equipment.

