

JUNIOR CARDIO KIDS GROUP CYCLE

MODELS: 659



"Motivating Kids to Move!"

www.kidsfit.com

2130 Cainhoy Road





Huger, SC 29450



Important Instructions

Please read these instructions carefully before using the equipment for the first time. They contain information which is important for your safety as well as for the use and maintenance of the unit. Keep these instructions in a safe place for reference purposes, to assist you when ordering spare parts, and maintenance work.

For Your Safety

-  ATTENTION! For indoor use only!
-  ATTENTION! This training device should be used only for its intended purpose.
-  ATTENTION! Any other use of the equipment is prohibited and may be dangerous. The manufacturer cannot be held liable for damage or injury caused by improper use of the equipment.
- Incorrect repairs and structural modifications may endanger the safety of the user.
- Worn or damaged parts should be replaced immediately and the equipment taken out of use until they have been repaired. Damaged components may endanger your safety or reduce the lifetime of the equipment.
- If the equipment is in regular use, check all its components thoroughly every 1-2 months. Pay particular attention to the tightness of bolts and nuts.
-  ATTENTION! Instruct children on possible sources of danger during exercising.
- Always wear suitable shoes when using exercise equipment.
- In choosing the location of the equipment, ensure it is a safe distance from any obstacles.
- The surface on which the unit is placed must be firm and even. Place rubber or straw mats under it to deaden any noise or impacts.

Handling the equipment

- It is not recommended to use or store the unit in a damp room as this may cause it to rust. Please ensure that no part of the machine comes in contact with liquids (drinks, perspiration, etc.). This may cause corrosion.
- Damaged components may endanger your safety or reduce the lifetime of the equipment. For this reason, worn or damaged parts should be replaced immediately and the equipment taken out of use until this has been done. Use only original Kidsfit spare parts.
- To ensure that the safety level is kept to the highest possible standard, determined by its construction, this product should be serviced regularly (once a year) by a qualified service tech.
- Please ensure that liquids or perspiration never enter the machine or the electronics.
- Before beginning your first training session, familiarize yourself thoroughly with all the functions and settings of the unit.
- When choosing a place for the equipment please ensure that the floor can withstand the additional weight/ load.

Proper Procedures for Use:

1. When seated on the bike make sure knees are in a slightly bent position when the ball of the foot is at its lowest point near the floor.
2. Back should be in a near flat position when user is gripping the handlebars. Feet should be inserted into the toe clips
3. Once feet are secured within toe clips begin pedaling slowly and gradually increase speed.
4. Instructor should make sure each student:
 - a. Maintains correct form and posture while on the bike.
 - b. Comes to a complete stop and takes both feet out of the foot clips before stepping off the bike.

MAINTENANCE SHEET
CARDIO KIDS JR. GROUP BIKE
MODEL: 659

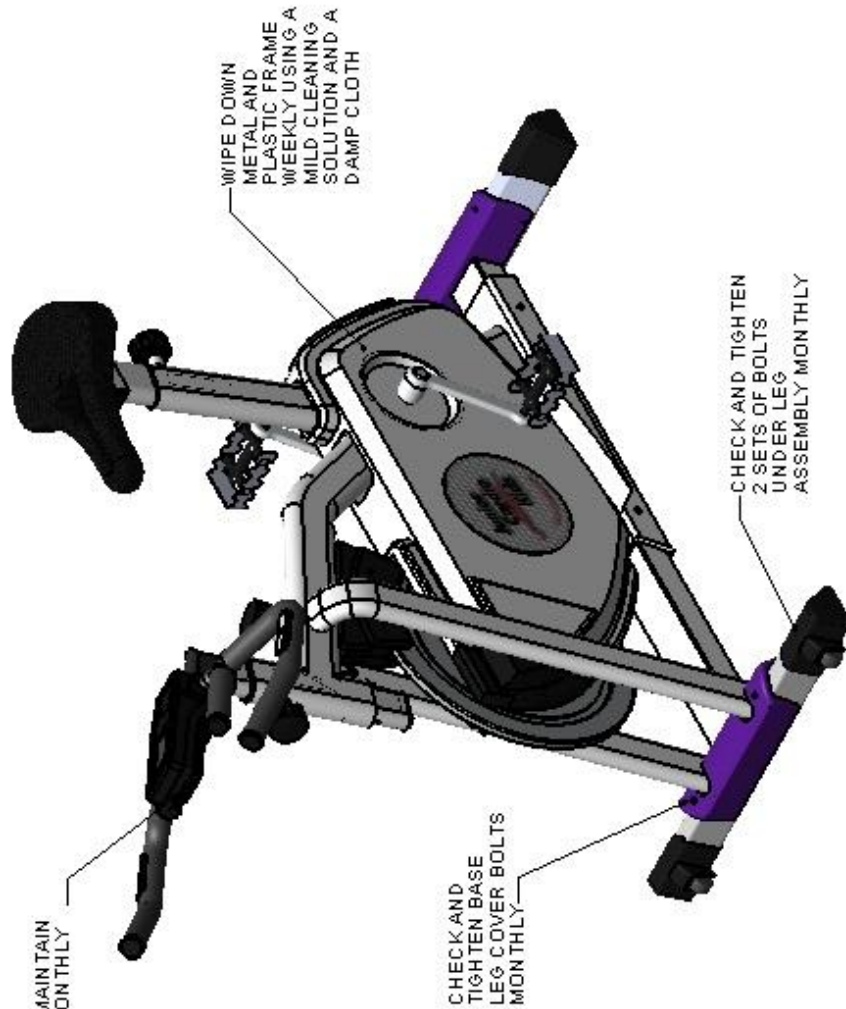

IT IS NOT RECOMMENDED TO USE OR STORE THE UNIT IN A DAMP ROOM AS THIS MAY CAUSE IT TO RUST. PLEASE ENSURE THAT NO PART OF THE MACHINE COMES IN CONTACT WITH LIQUIDS (DRINKS, PERSPIRATION ETC.). THIS MAY CAUSE CORROSION. DAMAGED COMPONENTS MAY ENDANGER YOUR SAFETY OR REDUCE THE LIFETIME OF THE EQUIPMENT. FOR THIS REASON, WORN OR DAMAGED PARTS SHOULD BE REPLACED IMMEDIATELY AND THE EQUIPMENT TAKEN OUT OF USE UNTIL THIS HAS BEEN DONE. USE ONLY ORIGINAL KID'S FIT SPARE PARTS. TO ENSURE THAT THE SAFETY LEVEL IS KEPT TO THE HIGHEST POSSIBLE STANDARD, DETERMINED BY ITS CONSTRUCTION, THIS PRODUCT SHOULD BE SERVICED REGULARLY (ONCE A YEAR) BY A QUALIFIED SERVICE TECH.



Replacement Parts List

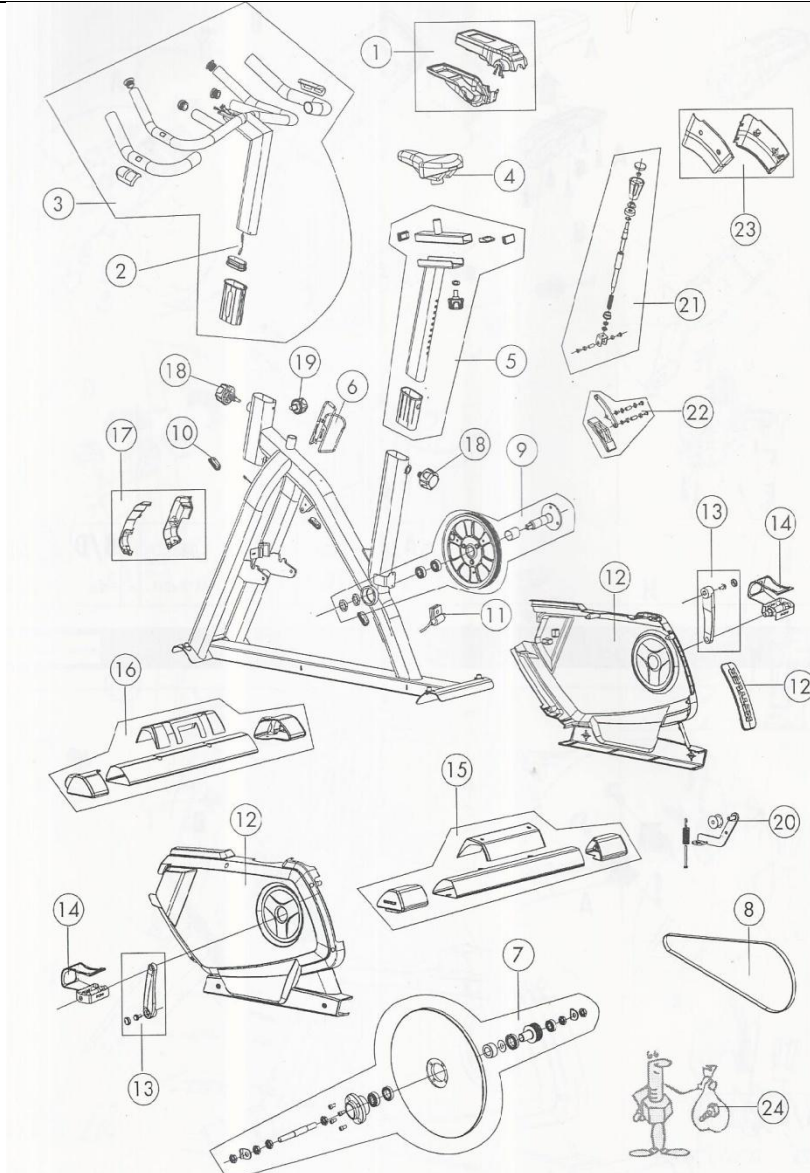

07639-000			07639-000		
①	1	68008200	⑬	1	68008014
②	1	68008002	⑭	1	68008015
③	1	68008203	⑮	1	68008218
④	1	68008204	⑯	1	68008219
⑤	1	68008205	⑰	1	68008220
⑥	1	68008006	⑱	2	68008221
⑦	1	68008009	⑲	1	68008222
⑧	1	68008010	⑳	1	68008223
⑨	1	68008210	㉑	1	68008224
⑩	2	68008019	㉒	1	68008008
⑪	1	68008012	㉓	1	68008225
⑫	1	68008214	㉔	1	68008226

**Please include the Model Number and Part Number when requesting replacement parts.

Programming Computer

Short description

The device has a function area with keys and a display area with varying symbols and graphics.

Function area / keys

MODE

When pressing the MODE key without accomplishing any training activities, the symbol P appears at the top left side. In this mode, all functions can be set.

By briefly pressing the MODE key, you select different functions [TIME, DISTANCE, CALORIES or PULSE], the display and your personal settings.

Keeping the MODE key pressed for a while will set all values to >0<.

SET

With the SET key, the standard values are set. For this the device must be in idle state > shown in the display in the upper left: P. Through shortly pressing the SET key, the setting values of the differing functions increases > [TIME; DISTANCE, CALORIES or PULSE]. If the SET key is pressed for a longer time, the setting values can be reached in a quicker counting sequence.

RESET

Pressing the RESET key will set the functions to >0<. When setting the default values of each function, only the value of each individual function will be set to >0< by shortly pressing the RESET key. Keeping the RESET key pressed for a longer time, all values are set to >0<; this corresponds to a restart of the computer. In this case, the time setting must be entered again.

When changing the batteries, all values are also reset to >0<.

RECOVERY

Nutzen Sie die RECOVERY-Taste zur Aktivierung der Erholungspulsfunktion nach dem Training.

Pulse measurement

Pulse can be measured in three different ways:

1. With hand pulse (standard)
2. With an ear clip (optional)

The connector is plugged into the jack.

3. With a chest strap + plug-in receiver (optional)

If the chest strap option is used, the chest strap must be connected with the training computer via a plug-in receiver. Chest strap and plug-in receiver can be ordered additionally.



Training and operating instructions

Indication area / display

On the display, one large-sized display plus several display segments in the lower area of the display appear at the same time.

After the completion of each training session, training data are saved and can be accessed for the next training session. Any new data are added.

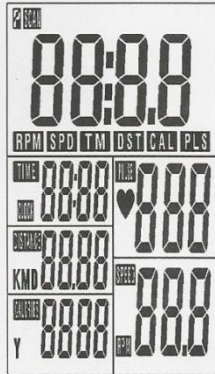

Time
24 hours



After the completion of the training session, or if the training session is interrupted, the computer switches to sleep mode after 4 minutes. Only time is displayed.

Training time
(TIME)



Displayed values between 0:00 – 99:59

Distance
(DISTANCE)
KM



Displayed values between 0.00 – 99.99

Energy consumption
CALORIES
(KCAL)



Displayed values between 0 – 9999

However, the data are only rough values comparing different exercises. They cannot be used for medical purposes.

Pulse
(PULSE)

The heart symbol flashes when signal is identified.

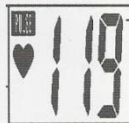

Displayed values between 40 – 220

As soon as you hold the handle sensors with both hands, the display indicates your current heart rate. You may enter a target value before starting the training. If the heart rate exceeds this target value, an acoustic alarm sounds to make you aware of such.

Step frequency
(RPM) – Round per Minute
Pedal rotation per minute

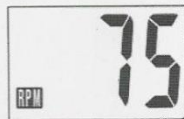

Displayed values
between 11 – 199

Speed
(SPEED)
(KM/H) or (Mi/H)



Displayed values
between
3.9 – 70.6 km/h
2.4 – 43.9 m/h

**Symbols
Meaning**

Stop / programme
When starting or
interrupting the training session



Setting functional options

Stop and SCAN
When training is interrupted



Changing the recent values of the
display to be indicated in large size
without counting

SCAN
Training

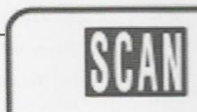

Change of display and counting of
individual values on the large-size
display during the training

Changing display of all functions in large size.
The abbreviation of each function appears on
the left side of the display.
TM = TIME = training time
DST = DISTANCE = distance covered
CAL = CALORIES = energy / calorific consump-
tion
PLS = PULSE = heart rate
RPM = Round Per Minute = step frequency
SPD = SPEED

For any value that appears on the large-size
display, the corresponding function flashes in
the small window.

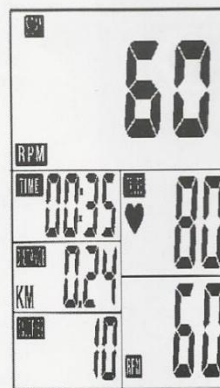

Large-size SCAN
display of e.g. RPM

Small-size SCAN
display of e.g. RPM

Training and operating instructions

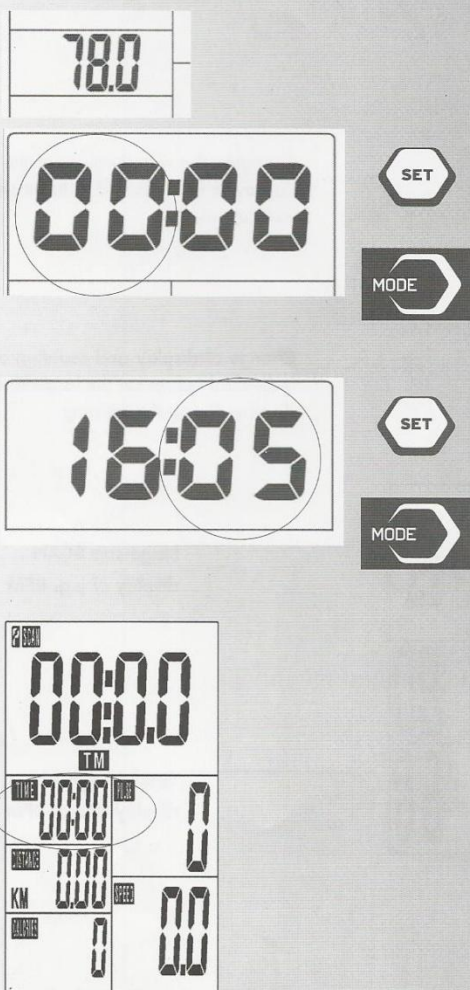
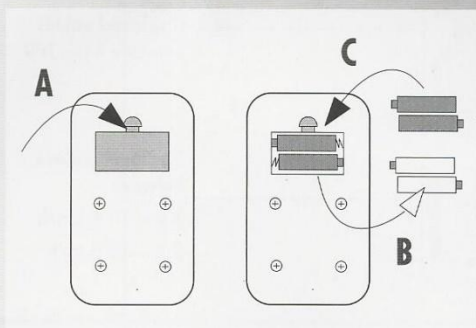

Starting the computer

Insert two batteries (1.5V UM 3/AA).

The computer starts a segment test indicating all available symbols plus confirmation sound. The figure "78.0" appears for a short time followed by the display for time setting – hour and minute "00:00".

Setting time

Time can be changed by pressing the SET and MODE keys:

The hour display flashes.

The current hour is set with the SET key. If you briefly press the SET key, the hour value is increased by one figure. Keeping the SET key pressed will accelerate the counting of the hour value to be set.

If the desired value has been missed by mistake, the SET key can be kept pressed for accelerated counting, or the RESET key can be pressed and counting will start from >0<.

Confirm the desired time value for the current hour with the MODE key.

The minute display flashes.

Set the time value for the current minute by means of SET, RESET and MODE as described above.

After having confirmed the time setting for the current minute by pressing the MODE key, you will return to the programme menu for the setting of your personal training default settings. The first field for TIME flashes, and TM is indicated on the large display.

Starting the computer without previous knowledge (guest)

With this setting, you can start your training even without previous knowledge. Any information is shown on the display. All values are counted from >0< upwards.

For efficient training and for setting your personal training default settings, please read and observe any further instructions provided in the chapter "Personal training default settings".

Training

Personal exercising specifications

General

- Without particular preliminary settings, the values in the individual functions [TIME, DISTANCE; CALORIES and PULSE] count from >0< upwards.
- For reasonable exercising, it is sufficient to merely set a target value in one function [TIME, DISTANCE, CALORIES or PULSE].
- If a personal target value is set as an exercise specification, the computer counts from this value downwards. When reaching the target value >0<, an acoustic signal sounds off. If afterwards, without setting of a new target value, you continue exercising, the computer counts in this mode from >0< upwards again.
- Once target values have been set, during exercising these cannot be changed, only during a standstill.

Target value specifications

The setting of the target values is the same with all functions: e.g. DISTANCE

1. Press the MODE key until in the field the number blinks in the field DISTANCE and the large number is in the display (identification > DST).
2. Through shortly pressing the key SET, you increase the value. E.g. DISTANCE in 0.5 km steps. If you press and hold the SET key, the set value is counted quicker.
3. If you would like to reduce the target value again, shortly press the RESET KEY: Counting will begin again from >0<. Press the SET key again until the target value has been reached.
4. If you have set the target value, press the MODE key. The value is then stored in this function and you go to the next function, e.g. CALORIES.
5. Enter the specification values if possible only in one function because otherwise the exercise goals will be overlapped. E.g. if you would reach the preset time goal earlier than the preset distance goal.
6. The specified values in the other functions [TIME; CALORIES or PULSE] are, as described with 1-4, also entered with the keys SET, RESET and MODE.

After finishing the presettings, you can begin with exercising.

During the exercise session, in the display the display of the different functions changes every 6 seconds. If you press the MODE key during this display, the selected function remains in the display in large numbers. In the small display the function name blinks, e.g. PULSE.

Pressing the MODE key again operates the SCAN operation > display change every 6 seconds.

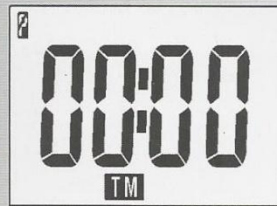

Training and operating instructions

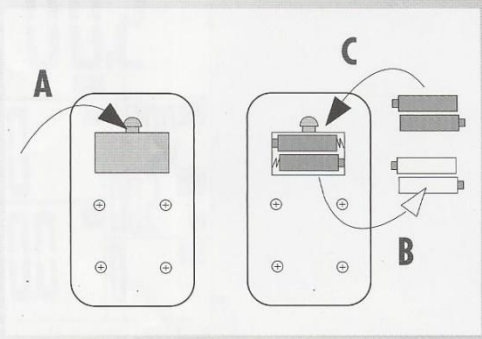

RECOVERY

Pressing the RECOVERY key will start the recovery pulse measurement at the end of the training unit. Deviations and your fitness level are calculated from your initial and final pulse. In case of equal training units, the improvement of the fitness level is a measurement for increased fitness.

As soon as the target values are reached, you can finish the training session, press the recovery key and rest your hands on the hand pulse sensors.

In the case of a previous pulse measurement, the display indicates 00:60 for time, and the current pulse value flashes on the PULSE segment display (right). Time count-down starts from 00:60. Rest your hands on the hand pulse sensors until the count-down has reached >0<.

A value between F1 and F6 is indicated on the display. F1 is the best and F6 the worst status. Pressing the RECOVERY key again will finish the function.

Calculation of fitness score

The computer calculates and assess the difference between the training and recovery heart rate and the resulting "fitness score" according to the following formula:

$$\text{Score (F)} = 6 - \frac{(10 \times (P1 - P2))^2}{P1}$$

P1 = Training pulse P2 = Recovery pulse
Score 1 = very good Score 6 = poor

A comparison of the training and recovery heart rate is a quick and easy way in which to determine physical fitness. The fitness score is an orientation value to assess your recovering ability after physical exercise. Before pressing the recovery heart rate button and determining your fitness score, you should train at your own level of intensity for a significant period of time e.g. 10 minutes. For regular cardiovascular training you will discover that your "fitness score" improves.

Change of batteries

If the display is only slightly illuminated, the batteries must be changed. The values and default settings of the previous training session will get lost. The time setting must be entered again.

Disposal of used batteries and storage batteries



This symbol tells you that batteries and storage batteries must not be disposed of with the normal household waste.

The symbols Hg (mercury) and Pb (lead) underneath the crossed-out rubbish bin also tell you that the battery or storage battery contains more than 0.0005% mercury or more than 0.004% lead.

Improper disposal damages the environment and can

damage people's health. Recycling of materials conserves precious raw materials. When disposing of the appliance, remove all batteries and storage batteries from the product and hand them over to the collection point for the recycling of batteries or electrical or electronic appliances. Information about the appropriate collection points can be obtained from your local authorities, your waste disposal team or in the outlet where this appliance was sold.

Possibilities for Pulse Measurement

The pulse measurement starts as soon as the heart in the display blinks in time with your pulse beat.

With ear clip

The pulse sensor works with infrared light and measures the variations in translucence in your skin, which are produced by your pulse beat. Rub your ear ten times strongly to activate the blood circulation before attaching the pulse sensor to your earlobe. Avoid disturbing pulses.

- Attach the ear clip properly to your earlobe and look for the best point for the measurement (heart symbol blinks without interruption).
- Do not train directly under strong incidence of light, e.g. neon light, halogen light, spotlight, sun light.
- Completely eliminate any shocks or bounces of the ear sensor and the cable. Always attach the cable with a clip at your clothing or, even better, at your headband.

With chest strap

If a chest strap should be used optionally, the connection between the chest strap and the training computer must be established by using a plug-in receiver. Chest strap and plug-in receiver can be ordered subsequently.







With hand pulse

An extra-low voltage caused by the contractions of your heart is registered by the hand sensors and evaluated by the electronics assembly of the device.

- Always grab the contact faces with both hands.
- Avoid jerky grasping.
- Hold your hands calmly and avoid contractions and rubbing on the contact faces.

Note:

Pulse measurement can be accomplished: by ear clip, by hand pulse, or by chest strap. If there is no ear clip or plug-in receiver in the pulse jack, hand pulse measurement is activated. If there is an ear clip or plug-in receiver in the pulse jack, the hand pulse measurement is automatically deactivated. There is no need to pull out the connector of the hand pulse sensors. Options for pulse measurement.

	
	
	
	<p>optional</p>

KIDSFIT
SPEC SHEET

JUNIOR GROUP BIKE
MODEL #659

FULLY ADJUSTABLE CHILD SIZED "SPIN BIKE". THIS BIKE IS DESIGNED TO FIT CHILDREN IN GRADES 3 THROUGH 6. CHILDREN'S SPIN BIKES HAVE ADJUSTABLE TOE CLIPS, SEATS AND HANDLEBARS. COMES COMPLETE WITH AN ONBOARD COMPUTER AND CONTACT HEART RATE SENSORS. PORTABLE WHEELS MAKE IT EASY TO KEEP THESE BIKES IN STORAGE WHEN NOT IN USE

WEIGHT: 100 LBS
SHIPPING WEIGHT: 125 LBS

REV: 10/11/14/2014

KIDSFIT
International Health Products
9110 CASHOY ROAD
MURRY, SC 29126
PROFESSIONAL AND COMMERCIAL
USE ONLY. NOT FOR RESIDENTIAL USE.
© 2014 KIDSFIT HEALTH PRODUCTS, INC.
ALL RIGHTS RESERVED.

